

Controls – Contactors and Contactor Assemblies

3



3/2	Introduction	
	3RT, 3TB, 3TF Contactors for Switching Motors	
3/5	General data	
3/11	3RT10 contactors, 3-pole, 3 ... 250 kW	3/130
3/55	3RT12 vacuum contactors, 3-pole, 110 ... 250 kW	3/136
3/64	3TF6 vacuum contactors, 3-pole, 335 ... 450 kW	3/137
3/71	3TB5 contactors with DC solenoid system, 3-pole, 55 ... 200 kW	3/141
3/76	3TF2 contactors, 3-pole, 2.2 ... 4 kW	3/145
	3RA13, 3RA14 Contactor Assemblies	
	<u>3RA13 Reversing Contactor Assemblies</u>	
3/84	3RA13 complete units, 3 ... 45 kW	3/148
	<u>3RA14 Contactor Assemblies for Wye-Delta Starting</u>	3/152
3/86	3RA14 complete units, 3 ... 75 kW	3/153
	3TD, 3TE Contactor Assemblies	
3/90	3TD6 reversing contactor assemblies, 335 kW	3/157
3/91	3TE6 contactor assemblies for wye-delta starting, 630 kW	
	3RT, 3RH, 3TB, 3TC, 3TH, 3TK Contactors for Special Applications	
	<u>3RT14 Contactors for Switching Resistive Loads (AC-1)</u>	
3/93	3-pole, 140 ... 690 A	3/164
	<u>3RT13 Contactors for Switching Resistive Loads (AC-1)</u>	
3/102	4-pole, 4 NO, 18 ... 140 A	3/164
	<u>3TK1 Contactors for Switching Resistive Loads (AC-1)</u>	
3/106	4-pole, 4 NO, 200 ... 1000 A	3/164
	<u>3TK20 Contactors</u>	
3/109	4-pole, 4 kW	3/164
	<u>3RT15 Contactors</u>	
3/116	4-pole, 2 NO + 2 NC, 4 ... 18.5 kW	3/164
	<u>3RT16 Capacitor Contactors</u>	
3/118	12.5 ... 50 kvar	3/164
	<u>Contactors with Extended Operating Range $0.7 \dots 1.25 \times U_{s2}$ for Railway Applications</u>	
3/120	3RH11 contactor relays	3/178
3/121	3TH4 contactor relays	3/179
3/122	3RT10 motor contactors, 5.5 ... 45 kW	3/221
3/124	3TB5 motor contactors, 55 ... 200 kW	
3/125	3TC contactors for switching DC voltage, 2-pole	
	<u>3TC Contactors for Switching DC Voltage</u>	
3/126	1- and 2-pole, 32 ... 400 A	
	3RH, 3TH Contactor Relays	
3/130	3RH1 contactor relays, 4- and 8-pole	
3/136	3RH14 latched contactor relays, 4-pole	
3/137	3TH4 contactor relays, 8- and 10-pole	
3/141	3TH2 contactor relays, 4- and 8-pole	
3/145	3RH11 coupling relays for switching auxiliary circuits, 4-pole	
	3RT Coupling Relays	
3/146	3RT10 coupling relays (interface), 3-pole, 3 ... 11 kW	
	3TX7, 3RS18 Coupling Relays	
	<u>3TX7 Coupling Relays, Narrow Design</u>	
3/148	Relay couplers	
3/152	Relay couplers with plug-in design	
3/153	Semiconductor couplers	
	<u>3RS18 Coupling Relays with Industrial Housing</u>	
3/157	Relay couplers	
	Coupling Relays with LZS/LZX Plug-In Relays	
3/160	Plug-in relay couplers	
	3TG10 Power Relays/Miniature Contactors	
3/164	4-pole, 4 kW	
	Accessories and Spare Parts	
	<u>For 3RT, 3RH Contactors and Contactor Relays</u>	
3/167	Accessories for 3RT, 3RH contactors and contactor relays	
	<u>For 3T Contactors and Contactor Relays</u>	
3/176	Accessories for 3TB, 3TC, 3TF, 3TG, 3TK contactors	
3/177	Accessories for 3TH contactor relays	
	Project Planning Aids	
3/178	- Overview	
3/179	- Dimensional drawings	
3/221	- Schematics	

Controls – Contactors and Contactor Assemblies

Introduction

Overview



Size	S00				S0					S2		
Type	3RT10 1				3RT10 2					3RT10 3		

3RT10 contactors • 3RT12 and 3TF68/69 vacuum contactors

Type AC, DC operation	3RT10 15	3RT10 16	3RT10 17	3RT10 23	3RT10 24	3RT10 25	3RT10 26	3RT10 34	3RT10 35	3RT10 36
--------------------------	-----------------	-----------------	-----------------	-----------------	-----------------	-----------------	-----------------	-----------------	-----------------	-----------------

Type	--			--				--		
------	----	--	--	----	--	--	--	----	--	--

AC-3

$I_e/AC-3/400\text{ V}$	A	7	9	12	9	12	17	25	32	40	50
400 V	kW	3	4	5.5	4	5.5	7.5	11	15	18.5	22
230 V	kW	2.2	3	3	3	3	4	5.5	7.5	11	15
500 V	kW	3.5	4.5	5.5	4.5	7.5	10	11	18.5	22	30
690 V	kW	4	5.5	5.5	5.5	7.5	11	11	18.5	22	22
1000 V	kW	--	--	--	--	--	--	--	--	--	--

AC-4 (for $I_a = 6 \times I_e$)

400 V	kW	3	4	4	4	5.5	7.5	7.5	15	18.5	22
400 V	kW	1.15	2	2	2	2.6	3.5	4.4	8.2	9.5	12.6
(200 000 operating cycles)											

AC-1 (40 °C, ≤ 690 V)

I_e	3RT10/12	A	18	22	22	40	40	40	40	50	60	60
-------	----------	----------	-----------	-----------	-----------	-----------	-----------	-----------	-----------	-----------	-----------	-----------

3RT14 AC-1 contactors

Type	--			--				--		
$I_e/AC-1/40\text{ °C}/\leq 690\text{ V}$	A	--		--				--		

Accessories for contactors

Auxiliary switch blocks front lateral	3RH19 11			3RH19 21				3RH19 21		
	--			3RH19 21						
Terminal covers	--			--				3RT19 36-4EA2		
Box terminal blocks	--			--				--		
Surge suppressors	3RT19 16			3RT19 26				3RT19 26/36		

3RU11 and 3RB20/21 overload relays (protection equipment: overload relays)

3RU11 , thermal, CLASS 10	3RU11 16	0.1 ... 12 A		3RU11 26	1.8 ... 25 A			3RU11 36	5.5 ... 50 A
3RB20/21 , solid-state, CLASS 5, 10, 20 and 30	3RB20 16	0.1 ... 12 A		3RB20 26	3 ... 25 A			3RB20 36	6 ... 50 A
	3RB21 16			3RB21 26				3RB21 36	
3RB22/23 , solid-state, CLASS 5, 10, 20 and 30	3RB2. 83 + 3RB29 06	0.3 ... 25 A						3RB2. 83 + 3RB29 06	10 ... 100 A

3RV10 motor starter protectors (protection equipment: motor starter protectors)

Type	3RV10 11	0.18 ... 12 A		3RV10 21	9 ... 25 A			3RV10 31	22 ... 50 A
Link modules	3RA19 11			3RA19 21				3RA19 31	

3RA13 reversing contactor assemblies

Complete units	Type	3RA13 15	3RA13 16	3RA13 17	3RA13 24	3RA13 25	3RA13 26	3RA13 34	3RA13 35	3RA13 36
400 V	kW	3	4	5.5	5.5	7.5	11	15	18.5	22
Assembly kits/wiring modules		3RA19 13-2A			3RA19 23-2A			3RA19 33-2A		
Mechanical interlocks		3RA19 12-2H			3RA19 24-1A/-2B					

3RA14 contactor assemblies for wye-delta starting

Complete units	Type	3RA14 15	3RA14 16	3RA14 23	3RA14 25	3RA14 34	3RA14 35	3RA14 36
400 V	kW	5.5	7.5	11	15/18.5	22/30	37	45
Assembly kits/wiring modules		3RA19 13-2B		3RA19 23-2B		3RA19 33-2B/-2C		

Note:

For safety characteristics for contactors see LV 1 2009 "Appendix" -> "Standards and approvals" -> "Overview".



S3
3RT1. 4



S6
3RT1. 5



S10
3RT1. 6



S12
3RT1. 7



S14
3TF6

	3RT10 44	3RT10 45	3RT10 46	3RT10 54	3RT10 55	3RT10 56	3RT10 64	3RT10 65	3RT10 66	3RT10 75	3RT10 76	--	
	--			--			3RT12 64	3RT12 65	3RT12 66	3RT12 75	3RT12 76	3TF68	3TF69
	65	80	95	115	150	185	225	265	300	400	500	630	820
	30	37	45	55	75	90	110	132	160	200	250	335	450
	18.5	22	22	37	45	55	55	75	90	132	160	200	260
	37	45	55	75	90	110	160	160	200	250	355	434	600
	45	55	55	110	132	160	200	250	250	400	400/500	600	800
	30	37	37	75	90	90	90/315	132/355	132/400	250/560	250/710	600	800
	30	37	45	55	75	90	110	132	160	200	250	355	400
	15.1	17.9	22	29	38	45	54/78	66/93	71/112	84/140	98/161	168	191
	100	120	120	160	185	215	275/330	330	330	430/610	610	700	910
	3RT14 46			3RT14 56			3RT14 66			3RT14 76		--	
	140			275			400			690		--	
	--												
	3TY7 561												
	3RT19 46-4EA1/2			3RT19 56-4EA1/2/3			3RT19 66-4EA1/2/3			3TX7 686/696			
	--			3RT19 55/56-4G			3RT19 66-4G			--			
	3RT19 56-1C (RC element)												
	3TX7 572												
	--												
	3RU11 46	18 ... 100 A		--			--			--		--	
	3RB20 46	12.5 ... 100 A		3RB20 56 50 ... 200 A			3RB20 66 55 ... 630 A			3RB20 66 160 ... 630 A		3RB20 66 160 ... 630 A	
	3RB21 46			3RB21 56			3RB21 66			3RB21 66		3RB21 66	
				3RB2. 83 + 3RB29 56 20 ... 200 A			3RB2. 83 + 3RB29 66 63 ... 630 A						
	3RV10 41	45 ... 100 A		--			--			--		--	
	3RA19 41			--			--			--		--	
	3RA13 44	3RA13 45	3RA13 46	--			--			--		3TD68 04	
	30	37	45	55	75	90	110	132	160	200	250	335	
	3RA19 43-2A			3RA19 53-2A			3RA19 63-2A			3RA19 73-2A		3TX7 680-1A	
				3RA19 54-2A								3TX7 686-1A	
	3RA14 44	3RA14 45		--			--			--		3TE68 04	
	55	75		--			--			--		630	
	3RA19 43-2B/-2C			3RA19 53-2B			3RA19 63-2B			3RA19 73-2B		3TX7 680-1B	

Controls – Contactors and Contactor Assemblies

Introduction

The advantages at a glance



3TX7



3RS18



LZS/LZX



3TG10

		Order No.	Page
Coupling links, narrow design			
Relay couplers	<ul style="list-style-type: none"> Width 6.2 mm (1 NO, 1 CO), 12.5 mm and 17.5 mm Output coupling links Input coupling links with hard gold-plating 	3TX7 002, 3TX7 003, 3TX7 004, 3TX7 005	3/148
Plug-in base couplers, complete with relay	<ul style="list-style-type: none"> Width 6.2 mm (1 NO, 1 CO) Relays, replaceable 	3TX7 014-1..00	3/152
Plug-in base couplers, complete with relay and hard gold-plating	<ul style="list-style-type: none"> Width 6.2 mm (1 CO) 	3TX7 014-1..02	3/152
Semiconductor couplers	<ul style="list-style-type: none"> Output 1 semiconductor, triac or transistor 	3TX7 002, 3TX7 004, 3TX7 005	3/152
Coupling relays in industrial housing			
Relay couplers	<ul style="list-style-type: none"> Protective separation up to 300 V between contacts and relay circuits 1, 2 and 3 changeover contacts Hard gold-plated contacts in combination and wide voltage range versions 	3RS18	3/157
Coupling relays with plug-in relays			
Plug-in relay couplers with 2, 3 and 4 changeover contacts	<ul style="list-style-type: none"> Switching capacity 12 A/10 A/6 A Width 27 mm Base optionally with or without logical isolation 	LZS/LZX:PT	3/160
Plug-in relay couplers with 1, 2 changeover contacts	<ul style="list-style-type: none"> Switching capacity 16 A/8 A Width 15.5 mm Base optionally with or without logical isolation 	LZS/LZX:RT	3/160
Plug-in relay couplers with 3 changeover contacts and circular base	<ul style="list-style-type: none"> Switching capacity 6 A 11-pole circular base Width 38 mm 	LZS/LZX:MT	3/160
Power relays			
With screw and flat connectors		3TG10	3/164

Connection method

The contactors and relays are available with screw terminals (box terminals and connecting bars) or with Cage Clamp terminals or spring-type terminals or with plug-type connectors. Some device types are also available with solder pin connections.



Screw terminals



Cage Clamp terminals or spring-type terminals



Flat connectors



Plug-in terminals



Solder pin connections

These connections are indicated in the Technical specifications by orange backgrounds.

Overview

3RT1 contactors and coupling relays
Size S00 with mountable accessories

The SIRIUS generation of controls is a complete, modular system family, logically designed right down to the last detail, from the basic units to the accessories.

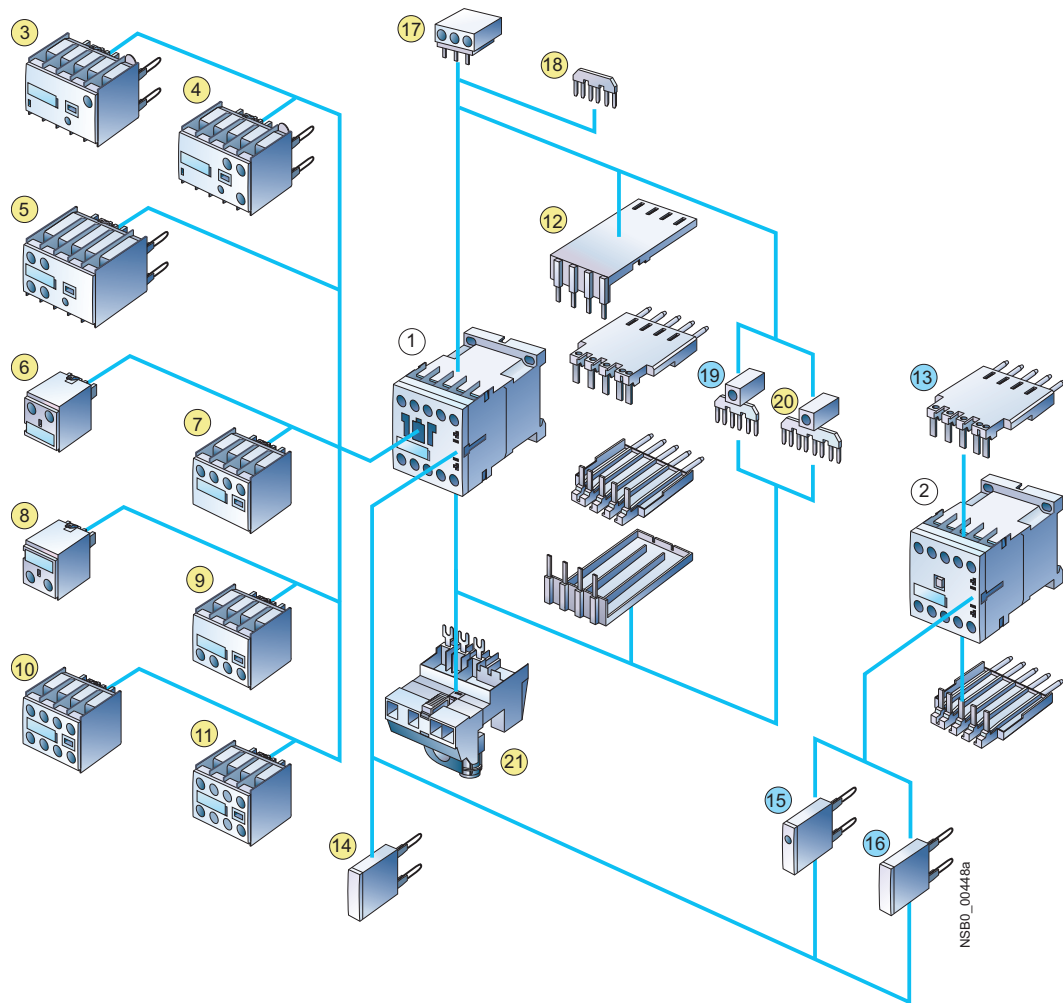

- ① Contactor
- ② Coupling relay

- ③ Solid-state timing relay block, with ON-delay
- ④ Solid-state timing relay block, with OFF-delay
- ⑤ Auxiliary switch block with solid-state time delay (ON or OFF-delay or wye-delta function)
- ⑥ 1-pole auxiliary switch block, cable entry from above
- ⑦ 2-pole auxiliary switch block, cable entry from above
- ⑧ 1-pole auxiliary switch block, cable entry from below
- ⑨ 2-pole auxiliary switch block, cable entry from below
- ⑩ 4-pole auxiliary switch block (terminal designations according to EN 50012 or EN 50005)
- ⑪ 2-pole auxiliary switch block, standard version or solid-state compatible version (terminal designations according to EN 50005)
- ⑫ Solder pin adapter for contactors with 4-pole auxiliary switch block
- ⑬ Solder pin adapter for contactors and coupling relays

- ⑭ Additional load module for increasing the permissible residual current
- ⑮ Surge suppressor with LED
- ⑯ Surge suppressor without LED
- ⑰ 3-phase feeder terminal
- ⑱ Link for paralleling (star jumper), 3-pole, without connection terminal
- ⑲ Link for paralleling, 3-pole, with terminal
- ⑳ Link for paralleling, 4-pole, with terminal
- ㉑ Connection module (adapter and connector) for contactors with screw-type connection

- For contactors
- For contactors and coupling relays (interface)

For contactor assemblies see pages 3/84 to 3/85.
 For assembly kit for reversing contactor assemblies (mech. interlocking, wiring modules) see Catalog LV 1.
 For mountable overload relays see "Protection Equipment --> Overload Relays".

For fuseless load feeders, see "Load Feeders, Motor Starters and Soft Starters -> 3RA Fuseless Load Feeders".

3RT, 3TB, 3TF Contactors for Switching Motors

General data

3RT1 contactors

Sizes S0 to S3 with mountable accessories

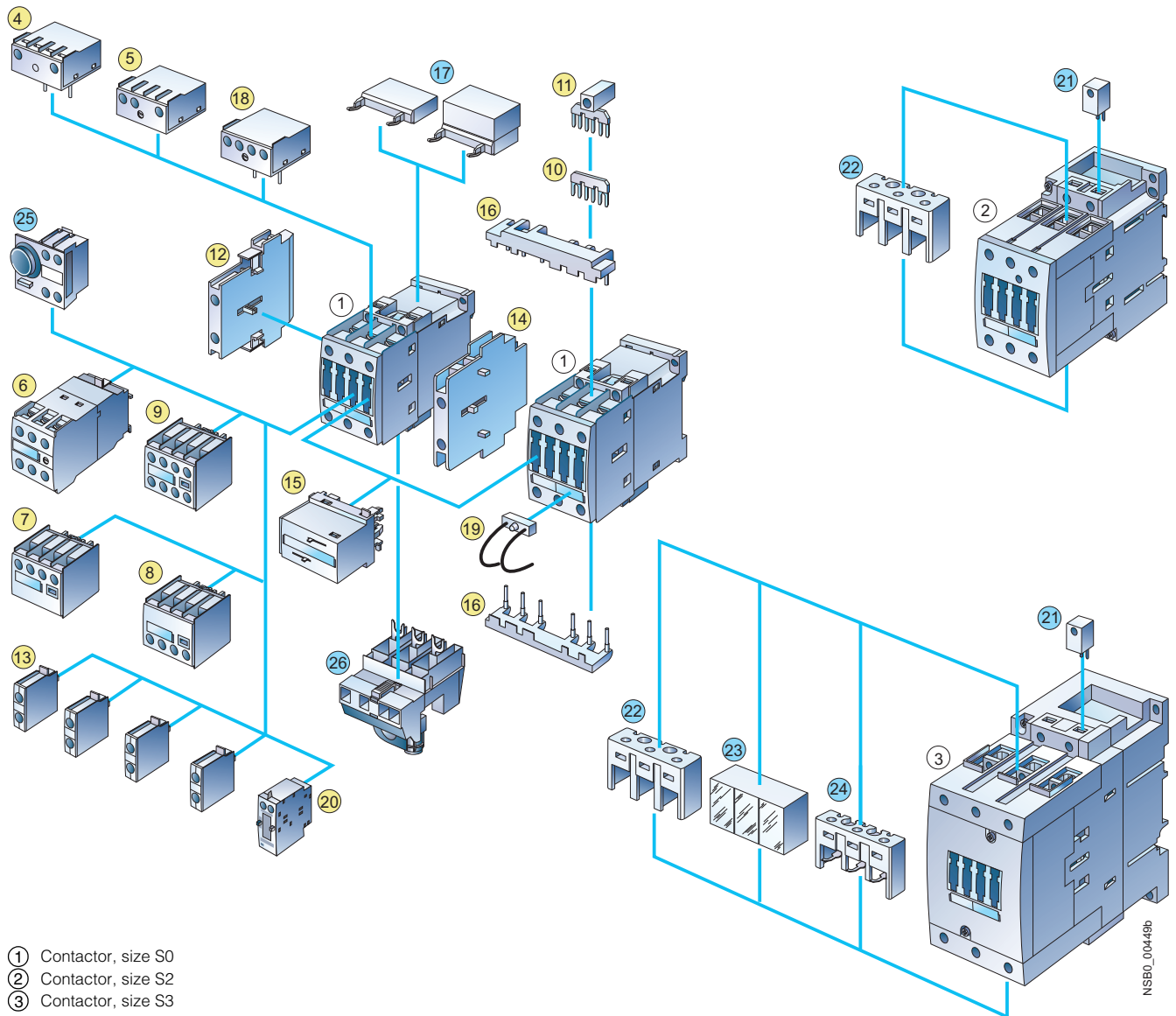

- ① Contactor, size S0
- ② Contactor, size S2
- ③ Contactor, size S3

For sizes S0 to S3:

- ④ Solid-state timing relay block, with ON-delay
- ⑤ Solid-state timing relay block, with OFF-delay
- ⑥ Auxiliary switch block with solid-state time delay (ON or OFF-delay or wye-delta function)
- ⑦ 2-pole auxiliary switch block, cable entry from above
- ⑧ 2-pole auxiliary switch block, cable entry from below
- ⑨ 4-pole auxiliary switch block (terminal designations according to EN 50012 or EN 50005)
- ⑩ Link for paralleling (star jumper), 3-pole, without connection terminal
- ⑪ Link for paralleling, 3-pole, with terminal
- ⑫ 2-pole auxiliary switch block, laterally mountable left or right (terminal designations according to EN 50012 or EN 50005)
- ⑬ Single-pole auxiliary switch block (up to 4 can be snapped on)
- ⑭ Mechanical interlock, laterally mountable
- ⑮ Mechanical interlock, mountable on the front
- ⑯ Wiring module on the top and bottom (reversing duty)
- ⑰ Surge suppressor (varistor, RC element, diode assembly), can be mounted on the top or bottom (different for S0 and S2/S3)

- ⑱ Coupling link for mounting directly onto contactor coil
- ⑲ LED module for indicating contactor operation

Only for size S0:

- ⑳ Pneumatic delay block
- ㉑ Connection module (adapter and connector) for contactors with screw-type connection

Only for sizes S0 and S2:

- ㉒ Mechanical latching

Only for sizes S2 and S3:

- ㉓ Coil repeat terminal for making contactor assemblies
- ㉔ Terminal cover for box terminals

Only for size S3:

- ㉕ Terminal cover for cable lugs and busbar connections
- ㉖ Auxiliary terminal, 3-pole

- Accessories identical for sizes S0 to S3
- Accessories differ according to size

NSB0_00449b

3RT, 3TB, 3TF Contactors for Switching Motors

General data

3RT1 contactors
Sizes S6 to S12 with accessories
(illustration for basic unit)

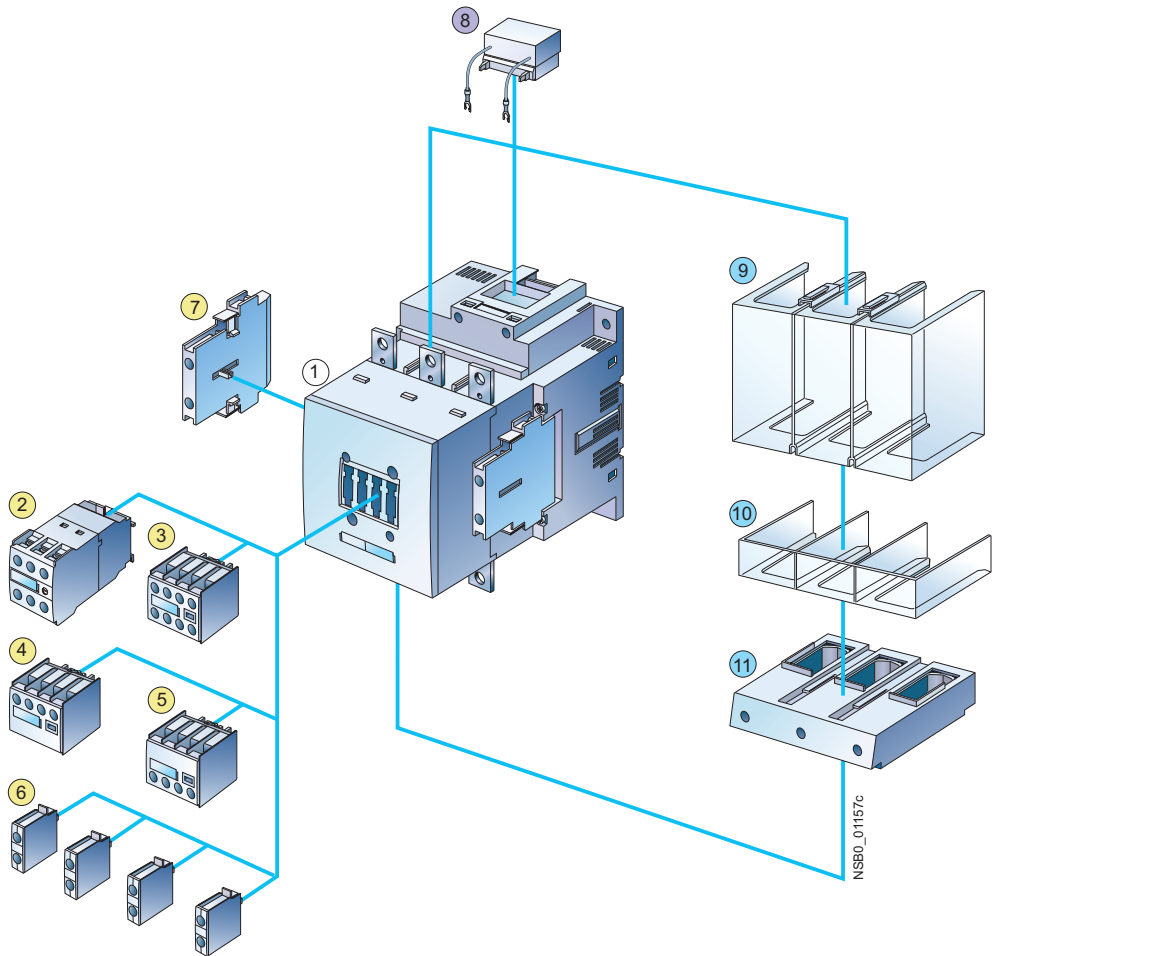

- ① 3RT10 and 3RT14 air-break contactor, sizes S6, S10 and S12
- ② Auxiliary switch block with solid-state time delay (ON or OFF-delay or wye-delta function)
- ③ 4-pole auxiliary switch block (terminal designations according to EN 50012 or EN 50005)
- ④ 2-pole auxiliary switch block, cable entry from above
- ⑤ 2-pole auxiliary switch block, cable entry from below
- ⑥ Single-pole auxiliary switch block (up to 4 can be snapped on)
- ⑦ 2-pole auxiliary switch block, laterally mountable left or right (terminal designations according to EN 50012 or EN 50005) (identical for S0 to S12)
- ⑧ Surge suppressor (RC element), for plugging into top of withdrawable coil

- ⑨ Terminal cover for cable lug and busbar connection, different for sizes S6 and S10/S12
- ⑩ Terminal cover for box terminal, different for sizes S6 and S10/S12
- ⑪ Box terminal block, different for sizes S6 and S10/S12

- Accessories identical for sizes S0 to S12
- Accessories identical for sizes S6 to S12
- Accessories differ according to size

For mountable overload relays see "Protection Equipment --> Overload Relays".

3RT, 3TB, 3TF Contactors for Switching Motors

General data

3RA1 contactor assemblies, 3RT1 contactors
Size S6 with accessories

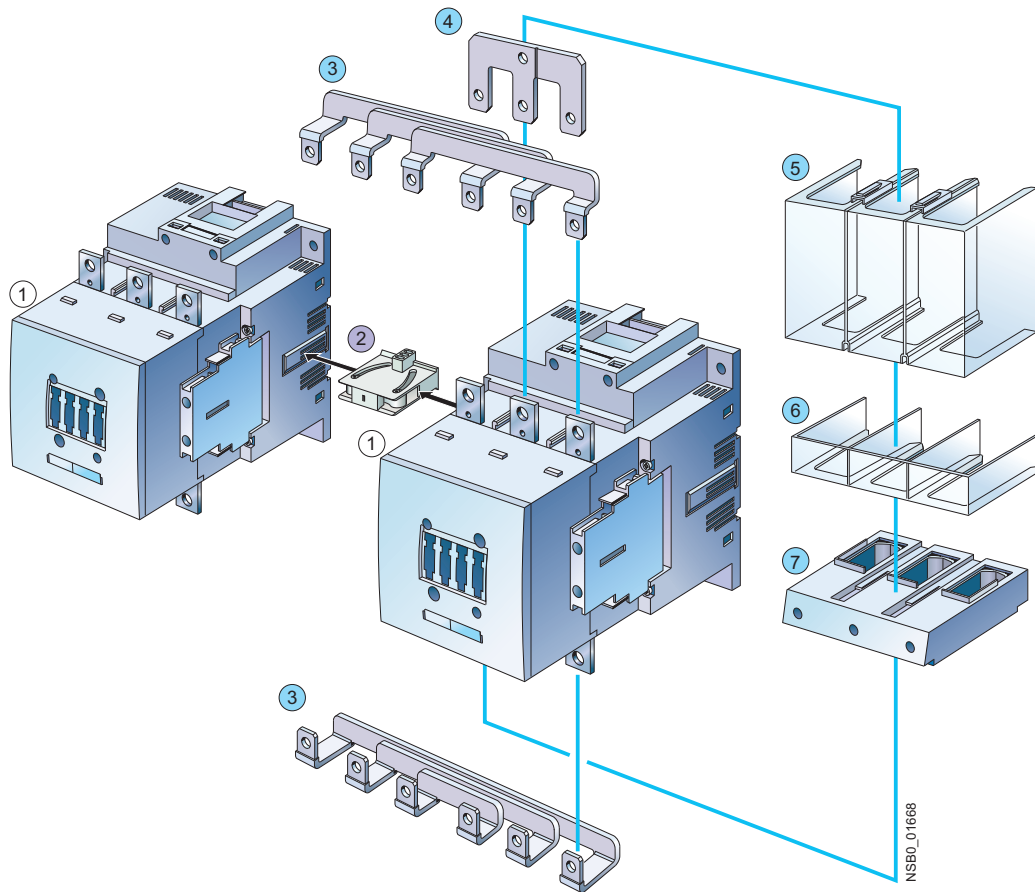

- ① 3RT10 and 3RT14 air-break contactor, size S6
- ② 3RA19 54-2A mechanical interlock, laterally mountable
- ③ 3RA19 53-2A wiring modules on the top and bottom
- ④ 3RT19 56-4BA31 link for paralleling (star jumper), 3-pole, with through hole
- ⑤ Terminal cover for cable lug and busbar connection, different for sizes S6 and S10/S12
- ⑥ Terminal cover for box terminal, different for sizes S6 and S10/S12
- ⑦ Box terminal block, different for sizes S6 and S10/S12

- Accessories identical for sizes S6 to S12
- Accessories differ according to size

For mountable overload relays see "Protection Equipment --> Overload Relays".

3RT, 3TB, 3TF Contactors for Switching Motors

General data

3RA1 contactor assemblies, 3RT1 contactors
Sizes S10 and S12 with accessories

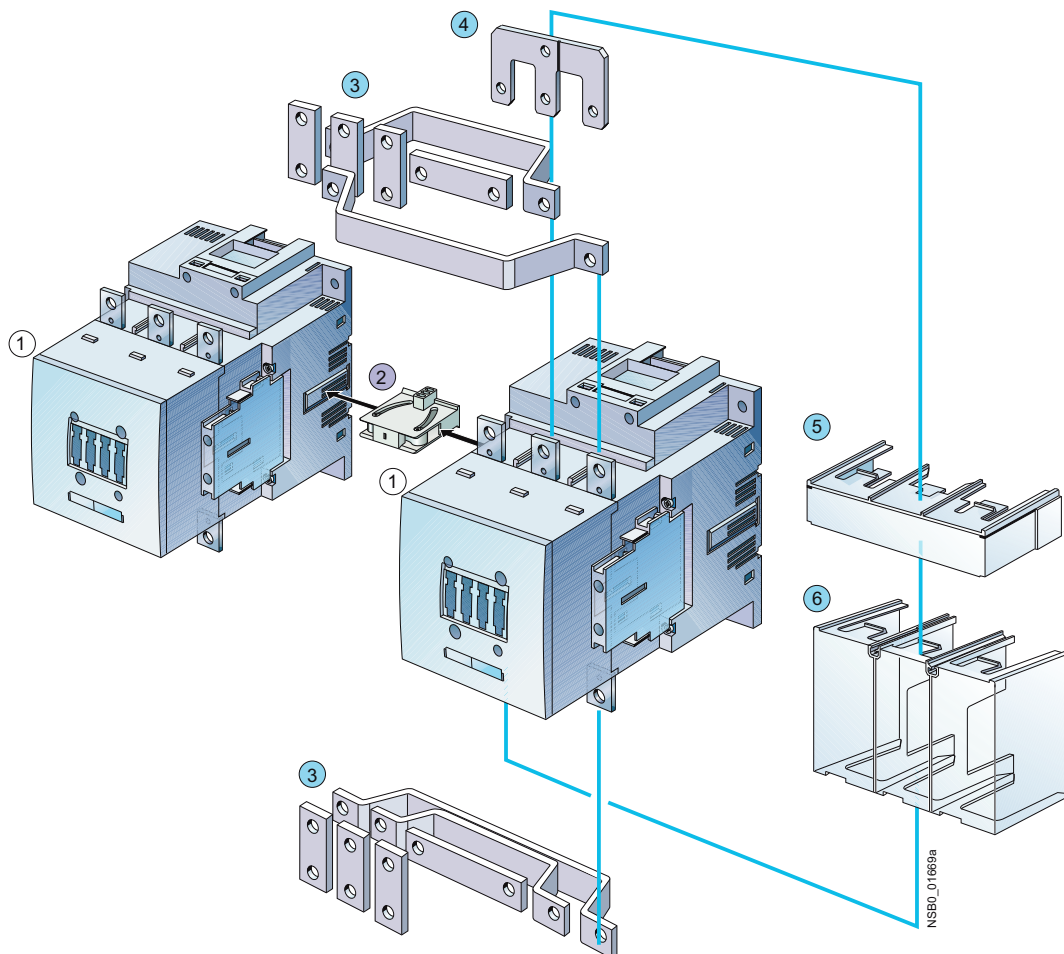

① 3RT10 and 3RT14 air-break contactor, sizes S6, S10 and S12 or
 3RT12 vacuum contactor, sizes S10 and S12

② Mechanical interlock, laterally mountable

③ 3RA19 wiring modules on the top and bottom

④ 3RT19 56-4BA31 link for paralleling (star jumper), 3-pole,
 with through hole

⑤ Terminal cover for box terminal,
 different for sizes S6 and S10/S12

⑥ Terminal cover for cable lug and busbar connection,
 different for sizes S6 and S10/S12

● Accessories identical for sizes S6 to S12

● Accessories differ according to size

For mountable overload relays see "Protection Equipment -->
 Overload Relays".

3RT, 3TB, 3TF Contactors for Switching Motors

General data

3RT1 contactors Sizes S6 to S12 with accessories

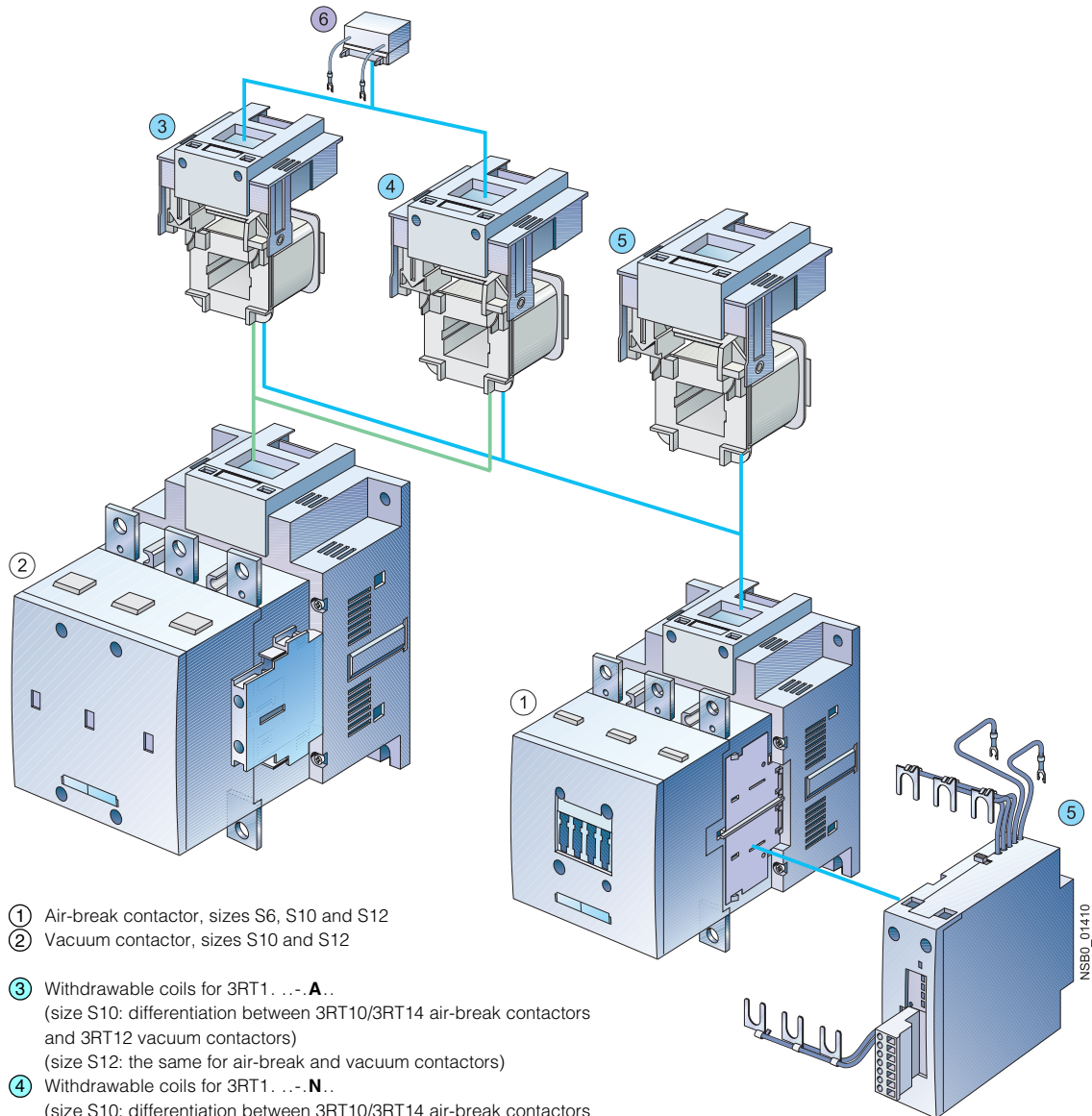

- ① Air-break contactor, sizes S6, S10 and S12
 ② Vacuum contactor, sizes S10 and S12
- ③ Withdrawable coils for 3RT1...-A...
 (size S10: differentiation between 3RT10/3RT14 air-break contactors and 3RT12 vacuum contactors)
 (size S12: the same for air-break and vacuum contactors)
- ④ Withdrawable coils for 3RT1...-N...
 (size S10: differentiation between 3RT10/3RT14 air-break contactors and 3RT12 vacuum contactors)
 (size S12: the same for air-break and vacuum contactors)
- ⑤ Withdrawable coils and laterally mountable module (plug-on) for air-break contactors with solid-state operating mechanism and remaining lifetime indicator 3RT1...-P... and 3RT1...-Q...
- ⑥ Surge suppressor (RC element), plug-mountable on withdrawable coils
- With conventional operating mechanism 3RT1...-A...
 - With solid-state operating mechanism 3RT1...-N...

- ① Identical for sizes S6 to S12
 ② Different according to size

For mountable overload relays see "Protection Equipment --> Overload Relays".

Overview

3RT10 contactors, 3-pole, sizes S00 to S3, up to 45 kW

AC and DC operation

IEC 60947, EN 60947 (VDE 0660)

The 3RT1 contactors are climate-proof. They are finger-safe according to EN 50274.

Size S00 contactors have an auxiliary contact integrated in the basic unit. The basic units of sizes S0 to S3 contain only the main current paths.

All basic units can be extended with auxiliary switch blocks. For size S0 and higher, complete units with 2 NO + 2 NC are available (connection designation according to EN 50012). The auxiliary switch block can be removed (for more information see [Integration](#)).

In addition, complete units with permanently mounted auxiliary switch block (2 NO + 2 NC according to EN 50012) are offered for sizes S00 and S0. These versions are built according to special Swiss regulations "SUVA" and are distinguished externally by a red labeling plate.

Connection method

The 3RT1 contactors are available with screw terminals (box terminals and connecting bars) or with Cage Clamp terminals.

The size S3 contactors have removable box terminals for the main conductor connections. This permits connection of ring terminal lugs or busbars.

Contact reliability

If voltages ≤ 110 V and current ≤ 100 mA are to be switched, the auxiliary contacts of the 3RT1 contactor or 3RH11 contactor relay should be used as they guarantee a high level of contact reliability.

These auxiliary contacts are suitable for solid-state circuits with currents ≥ 1 mA at a voltage of 17 V.

Short-circuit protection of the contactors

[Short-circuit protection of the contactors without overload relay, see "Technical specifications". For short-circuit protection of the contactors with overload relay, see "Overload Relays".](#) To assemble fuseless motor feeders you must select combinations of motor starter protector and contactor as explained in "Fuseless Load Feeders".

Motor protection

3RU11 thermal overload relays or 3RB20 solid-state overload relays can be fitted to the 3RT1 contactors for protection against overload. The overload relays must be ordered separately.

Ratings of induction motors

The quoted rating (in kW) refers to the output power on the motor shaft (according to the nameplate).

Surge suppression

3RT1 contactors can be retrofitted with RC elements, varistors, diodes or diode assemblies (assembly of diode and Zener diode for short break times) for damping opening surges in the coil.

The surge suppressors are plugged onto the front of size S00 contactors. Space is provided for them next to a snap-on auxiliary switch block.

For size S0 to S3 contactors, varistors and RC elements can be snapped on either on the top or directly below the coil terminals. Diode assemblies are available in 2 different versions on account of their polarity. Depending on the application they can be connected either only at the bottom (assembly with motor starter protector) or only at the top (assembly with overload relay).

The plug-in direction of the diodes and diode assemblies is specified by coding.

Exceptions:

3RT19 26-1T.00 and

3RT19 36-1T.00, in this case the plug-in direction is marked with "+" and "-".

Coupling relays are supplied either without overvoltage damping or with a varistor or diode connected as standard, according to the version.

Note:

The OFF-delay times of the NO contacts and the ON-delay times of the NC contacts increase if the contactor coils are damped against voltage peaks (noise suppression diode 6 to 10 times; diode assemblies 2 to 6 times, varistor +2 to 5 ms).

3RT10 contactors, 3-pole, sizes S6 to S12, > 45 to 250 kW

- 3RT10, contactors for switching motors,
- 3RT12, vacuum contactors for switching motors,
- 3RT14, contactors for AC-1 applications.

Operating mechanism types

Two types of solenoid operation are available:

- Conventional operating mechanism
- Solid-state operating mechanism (with 3 performance levels)

UC operation

The contactors can be operated with AC (40 to 60 Hz) as well as with DC.

Withdrawable coils

For simple coil replacement, e. g., if the application is replaced, the magnetic coil can be pulled out upwards after the release mechanism has been actuated and can be replaced by any other coil of the same size.

Auxiliary contact complement

For details of the auxiliary switch fittings per S0-S12 contactor see page 3/16.

- 3RT10 and 3RT14 contactors:
Auxiliary contacts mounted laterally and on front
- 3RT12 vacuum contactors:
Auxiliary contacts mounted laterally

Note:

Auxiliary contact complement according to SUVA.

Contactors with permanently mounted auxiliary switch block for safety applications according to SUVA.

Contactors with conventional operating mechanism

Version 3RT1. ...A:

The magnetic coil is switched directly on and off with the control supply voltage U_s by way of terminals A1/A2.

Multi-voltage range for the control supply voltage U_s :
Several closely adjacent control supply voltages, available around the world, are covered by just one coil, for example 110-115-120-127 V UC or 220-230-240 V UC.

In addition, allowance is also made for a coil operating range of 0.8 times the lower ($U_{s \min}$) and 1.1 times the upper ($U_{s \max}$) rated control supply voltage within which the contactor switches reliably and no thermal overloading occurs.

3RT, 3TB, 3TF Contactors for Switching Motors

3RT10 contactors, 3-pole, 3 ... 250 kW

Contactors with solid-state operating mechanism

The magnetic coil is supplied selectively with the power required for reliable switching and holding by upstream control electronics.

- Wide voltage range for the control supply voltage U_s : Compared with the conventional operating mechanism, the solid-state operating mechanism covers an even broader range of control supply voltages used worldwide within one coil variant. For example, the coil for 200 to 277 V UC ($U_{s \min}$ to $U_{s \max}$) covers the voltages 200-208-220-230-240-254-277 V used worldwide.
- Extended operating range 0.7 to $1.25 \times U_s$: The wide range for the rated control supply voltage and the additionally allowed coil operating range of $0.8 \times U_{s \min}$ to $1.1 \times U_{s \max}$ results in an extended coil operating range of at least 0.7 to $1.25 \times U_s$, within which the contactors will operate reliably, for the most common control supply voltages of 24, 110 and 230 V.
- Bridging temporary voltage dips: Control voltage failures dipping to 0 V (at A1/A2) are bridged for up to approx. 25 ms to avoid unintentional tripping.
- Defined ON and OFF thresholds: For voltages of $\geq 0.8 \times U_{s \min}$ and higher the electronics will reliably switch the contactor ON, and as of $\leq 0.5 \times U_{s \min}$ it is reliably switched off. The hysteresis in the switching thresholds prevents the main contacts from chattering as well as increased wear or welding when operated in weak, unstable networks. This also prevents thermal overloading of the contactor coil if the voltage applied is too low (contactor does not close properly and is continuously operated with overexcitation).
- Low control power consumption when closing and in the closed state.

Electromagnetic compatibility (EMC)

The contactors with solid-state operating mechanism comply with the requirements for operation in industrial plants.

- Interference immunity
 - Burst (IEC 61000-4-4): 4 kV
 - Surge (IEC 61000-4-5): 4 kV
 - Electrostatic discharge, ESD (IEC 61000-4-2): 8/15 kV
 - Electromagnetic field (IEC 61000-4-3): 10 V/m
- Emitted interference
 - Limit value class A according to EN 55011

Note:

In connection with converters, the control cables should be installed separately from the load cables of the converter.

Indication of remaining lifetime (RLT)

Main contactor contacts are working parts which must be replaced in good time when the end of their service life has been reached. The degree of contact erosion and thus the electrical endurance (= number of operating cycles) depends on the loading, utilization category, operating mode, etc. Up to now, routine checks/visual inspections by the maintenance personnel were needed in order to gain an insight into the state of the main contacts. The remaining lifetime indication function now takes over this task. It does not count the number of operating cycles – which does not provide information about contact erosion – but instead electronically identifies, evaluates and stores the actual progress of erosion of each one of the three main contacts, and outputs a warning when specified limits are reached. The stored data are not lost even if the control supply voltage for A1/A2 fails. After replacement of the main contacts, measurement the remaining lifetime must be reset using the "RESET" button (hold down RESET button for about 2 seconds using a pen or similar tool).

Advantages:

- Signaling through relay contact or AS-i when remaining life-time is 20 %, i. e. contact material wear is 80 %
- Additional visual indication of various levels of erosion by means of LEDs on the laterally mounted solid-state module when remaining lifetime is 60 % (green), 40 % (orange) and 20 % (red)

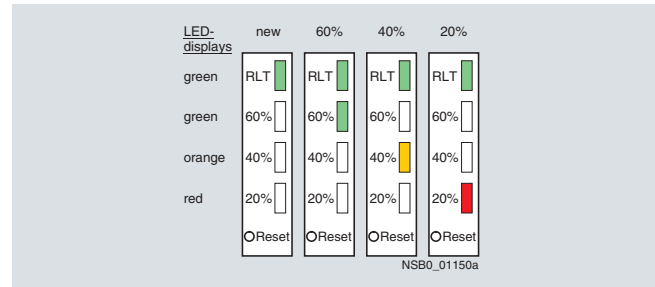

- Early warning to replace contacts
- Optimum utilization of contact material
- Visual inspection of the condition of contacts no longer necessary
- Reduction of ongoing operating costs
- Optimum planning of maintenance measures
- Avoidance of unforeseen plant downtimes

3RT1. ...-N version: for 24 V DC PLC output

2 control options:

- Control without a coupling link directly through a 24 V DC ≥ 30 mA PLC output (EN 61131-2). Connection by means of 2-pole plug-in connection. The screwless spring-type connection is part of the scope of supply. The control supply voltage which supplies the solenoid operating mechanism must be connected to A1/A2.

Note:

Before start-up, the slide switch for PLC operation must be moved to the "PLC ON" position (setting ex works: "PLC OFF").

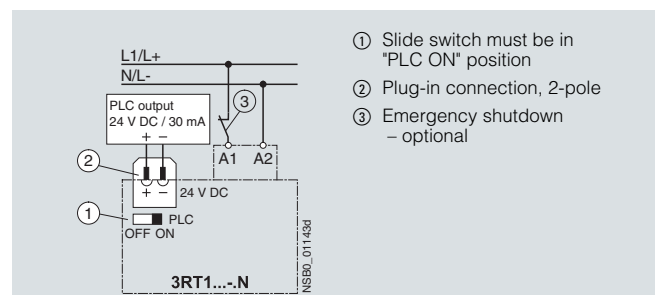

- Conventional control by applying the control supply voltage at A1/A2 through a switching contact.

Note:

The slide switch must be in the "PLC OFF" position (= setting ex works).

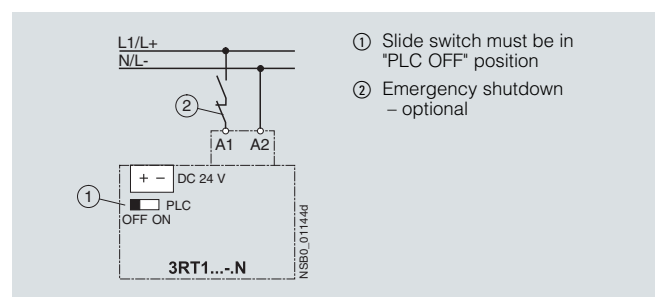

3RT, 3TB, 3TF Contactors for Switching Motors

3RT10 contactors, 3-pole, 3 ... 250 kW

3RT1...-P version: For 24 V DC PLC output or PLC relay output, with remaining lifetime indicator (RLT).

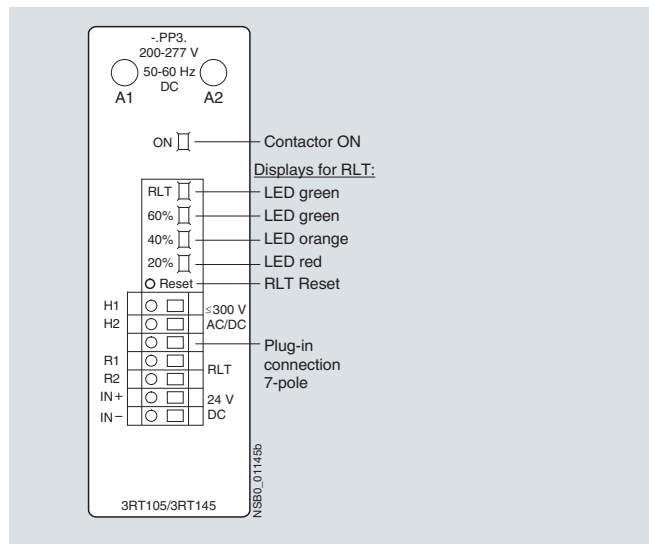

- Contactor control through relay outputs, e. g. by
 - PLC
 - SIMOCODE
- by way of terminals H1/H2. Contact loading: U_s /approx. 5 mA. When operated through SIMOCODE, a communication link to PROFIBUS DP is also provided.

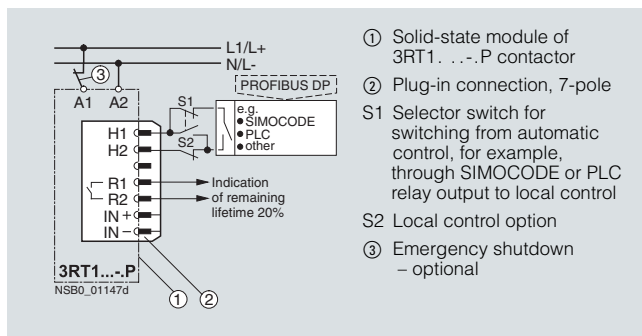

- ① Solid-state module of 3RT1...-P contactor
 - ② Plug-in connection, 7-pole
- S1 Selector switch for switching from automatic control, for example, through SIMOCODE or PLC relay output to local control
- S2 Local control option
- ③ Emergency shutdown - optional

To supply the solenoid and the remaining lifetime indicator with power, the control supply voltage U_s must be connected to terminals A1/A2 of the laterally mounted solid-state module. The control inputs of the contactor are connected to a 7-pole plug-in connection; the screwless spring-type connection is part of the scope of supply.

- The "Remaining Lifetime RLT" status signal is available at terminals R1/R2 through a floating relay contact (hard gold-plated, enclosed) and can be input to SIMOCODE, PLC or other devices for processing, for example. Permissible current-carrying capacity of the R1/R2 relay output:
 - I_{θ} /AC-15/24 to 230 V: 3 A
 - I_{θ} /DC-13/24 V: 1 A
- LED indications
The following states are indicated by means of LEDs on the laterally mounted solid-state module:
 - Contactor ON (energized state): green LED ("ON")
 - Indication of remaining lifetime

2 control options:

- Contactor control without a coupling link directly through a 24 V DC/ ≥ 30 mA PLC output (EN 61131-2) by way of terminals IN+/IN-.

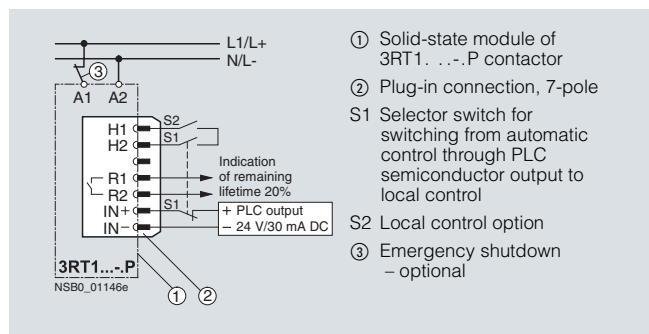

- ① Solid-state module of 3RT1...-P contactor
 - ② Plug-in connection, 7-pole
- S1 Selector switch for switching from automatic control through PLC semiconductor output to local control
- S2 Local control option
- ③ Emergency shutdown - optional

Possibility of switching from automatic control to local control by way of terminals H1/H2, i. e. automatic control through PLC or SIMOCODE/PROFIBUS DP can be deactivated e. g. at start-up or in the event of a fault and the contactor can be controlled manually.

3RT1...-Q version: Communication-capable with integrated AS-Interface and remaining lifetime indicator (RLT)

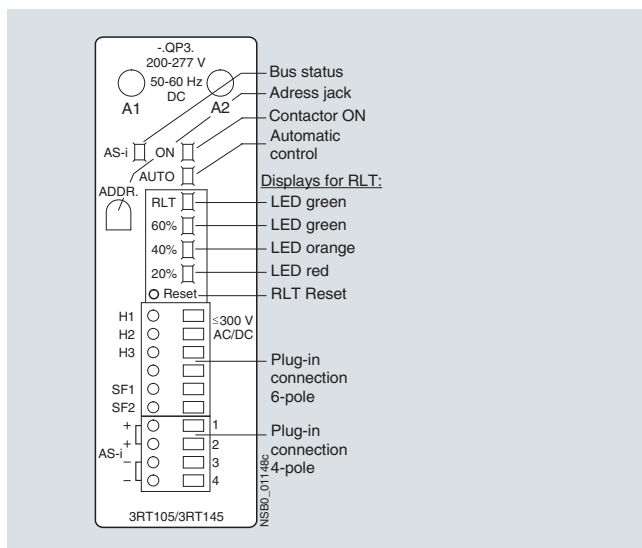

To supply the solenoid and the remaining lifetime indicator with power, the control supply voltage U_s must be connected to terminals A1/A2 of the laterally mounted solid-state module. The contactor itself is controlled by way of the integrated AS-Interface interface. The inputs and outputs are connected to a 10-pole plug-in connection; the screwless spring-type connections (6-pole for external connection and 4-pole for AS-Interface connection) are part of the scope of supply.

- LED indications
The following states are indicated by means of LEDs on the laterally mounted solid-state module:
 - Contactor ON (energized state): green LED ("ON")
 - Automatic/Local control: green LED ("AUTO")
 - Bus status: green/red dual LED ("AS-i")
 - Remaining lifetime indicator (RLT)
- AS-Interface addressing socket "ADDR":
The contactor address can be assigned after installation.

3RT, 3TB, 3TF Contactors for Switching Motors

3RT10 contactors, 3-pole, 3 ... 250 kW

Control circuit:

- Contactor control through AS-Interface by way of terminals AS-i +/AS-i -. Each of these terminals is jumpered and connected twice to a 4-pole connector which is separate from the other control inputs.

Advantages:

- The AS-Interface cable is not interrupted if the connector is pulled out
- The contactor remains functional through the local control inputs and its own 6-pole connector
- Control signals through AS-i:
 - Contactor ON/OFF
- Status signals through AS-i:
 - Contactor ON/OFF
 - Automatic/local control
 - Remaining lifetime indicator (RLT)
 - Signal through free input, e. g. overload relay tripped.

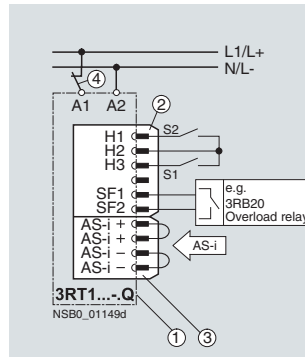

- ① Solid-state module of 3RT1...-Q contactor
- ② Plug-in connection, 6-pole
- ③ Plug-in connection, 4-pole
- S1 Selector switch for switching from automatic control, for example, through AS-Interface to local control
S1 open: Automatic mode
- S2 Local control option
- ④ Emergency shutdown - optional

Possibility of switching from automatic control to local control by means of terminals H1/H2/H3, i. e. automatic control through AS-Interface can be deactivated e. g. during startup or in the event of a fault and the contactor can be controlled manually.

I/O configuration (hex)	7
ID code (hex)	F
Power supply	V 26.5 ... 31.6 (acc. to AS-Interface specification)
AS-Interface power consumption	mA Max. 20
Contact loading at SF1/2	mA 3 ... 6
Watchdog function (disconnects outputs in the event of AS-Interface fault)	Built-in

Indication behavior

During operation, the LEDs on the contactor indicate the states shown on the right.

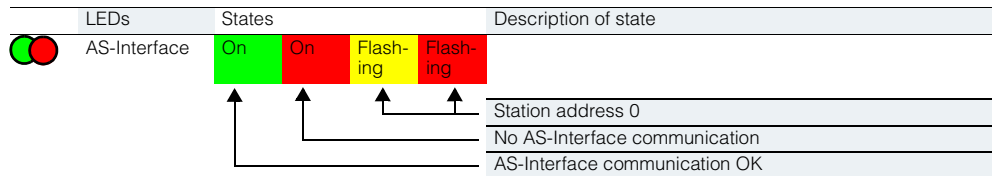

Contactor diagnostics using the user program

Inputs

Input signals	Device status
D10 "Ready"	0 Device not ready/manual operation 1 Device ready/automatic mode
D11 "Running"	0 Contactor off 1 Contactor on
D12 "Remaining lifetime"	0 Remaining lifetime RLT > 20 % 1 Remaining lifetime RLT ≤ 20 %
D13 "Free input"	0 No input signal at SF1/2 1 Input signal at SF1/2

Outputs

Output signals	Device status
DO0 "Running"	0 Contactor off 1 Contactor on
DO1	0 -- 1 --
DO2	0 -- 1 --
DO3	0 -- 1 --

Integration

Auxiliary switch blocks

Various auxiliary switch blocks can be added to the 3RT1 basic units depending on the application:

Size S00

3RT10 1. contactors

Terminal designations according to EN 50012 or EN 50005.

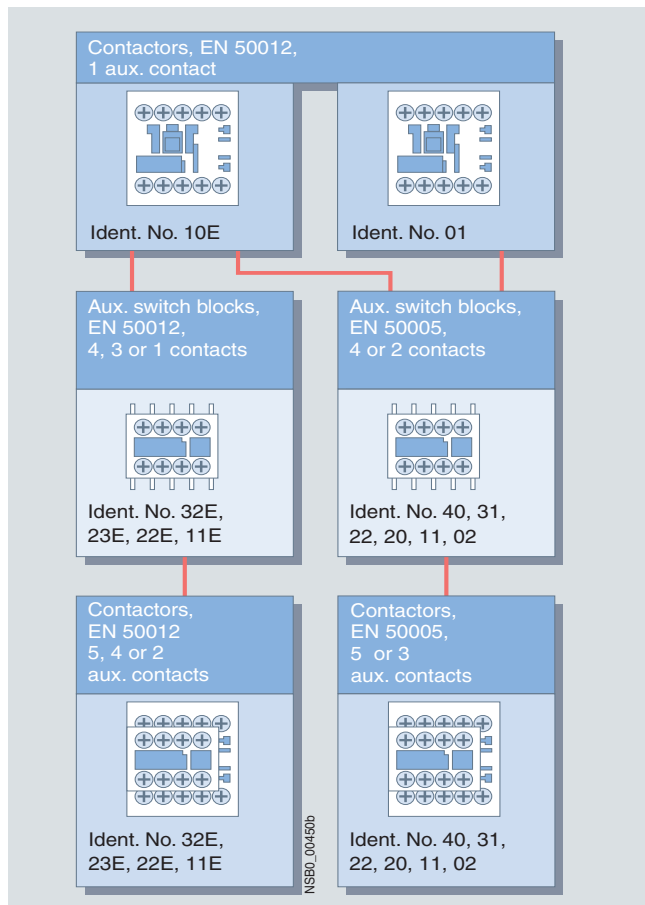

Size S00 contactors have an auxiliary contact integrated in the basic unit.

Contactors with a NO contact as auxiliary contact with screw or Cage Clamp terminals, identification number 10E, can be expanded into contactors with 2, 4 and 5 auxiliary contacts according to EN 50012 using auxiliary switch blocks. The identification numbers 11E, 22E, 23E and 32E on the auxiliary switch blocks apply to the complete contactors. These auxiliary switch blocks cannot be combined with contactors which have a NC contact in the basic unit (identification number 01) as they are coded.

All contactors of size S00 with one auxiliary contact (identification numbers 10E or 01) and the contactors with 4 main contacts can be expanded into contactors with 3 or 5 auxiliary contacts using auxiliary switch blocks with the identification numbers 40 to 02 (in the case of contactors with 4 main contacts: 2 or 4 auxiliary contacts) according to EN 50005.

The identification numbers on the auxiliary switch blocks apply only to the attached auxiliary switches. Single- or two-pole auxiliary switch blocks with connection options from above or below enable easy and clearly arranged wiring especially for the installation of network access junctions. These auxiliary switch blocks are offered only with screw terminals.

The solid-state compatible 3RH19 11-1NF.. auxiliary switch blocks for contactors of size S00 include 2 enclosed contacts. They are suitable in particular for switching small voltages and currents (hard gold-plated contacts) and for operation in dusty atmospheres. The NC auxiliary contacts are not mirror contacts.

All the previously mentioned auxiliary switch variants can be snap-fitted onto the front of the contactor. The auxiliary switch block has a centrally positioned release lever for disassembly.

Sizes S0 to S3

3RT10 2. to 3RT10 4. contactors, 1-pole auxiliary switch blocks,

terminal designations according to EN 50005 or EN 50012.

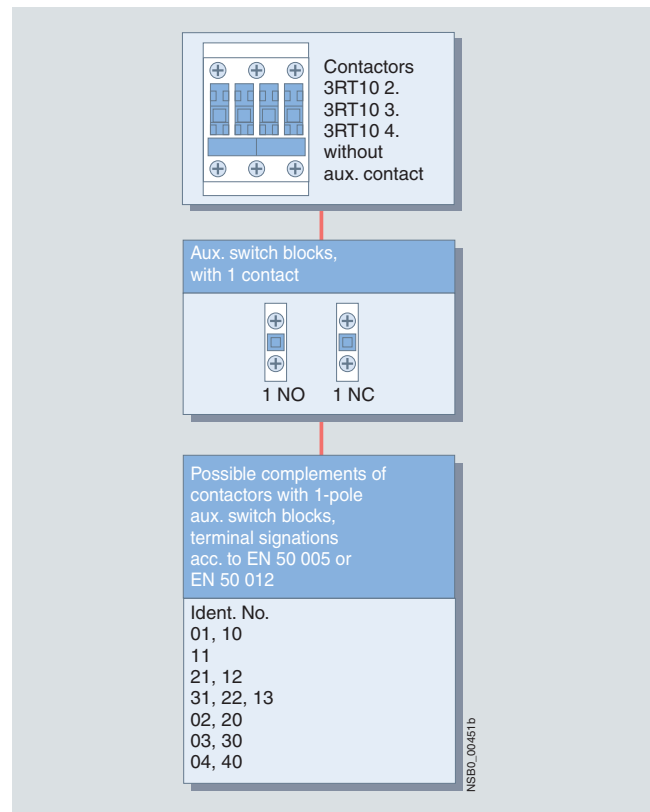

3RT, 3TB, 3TF Contactors for Switching Motors

3RT10 contactors, 3-pole, 3 ... 250 kW

3RT10 2. to 3RT10 4. contactors, 4-pole auxiliary switch blocks, terminal designations according to EN 50005 or EN 50012

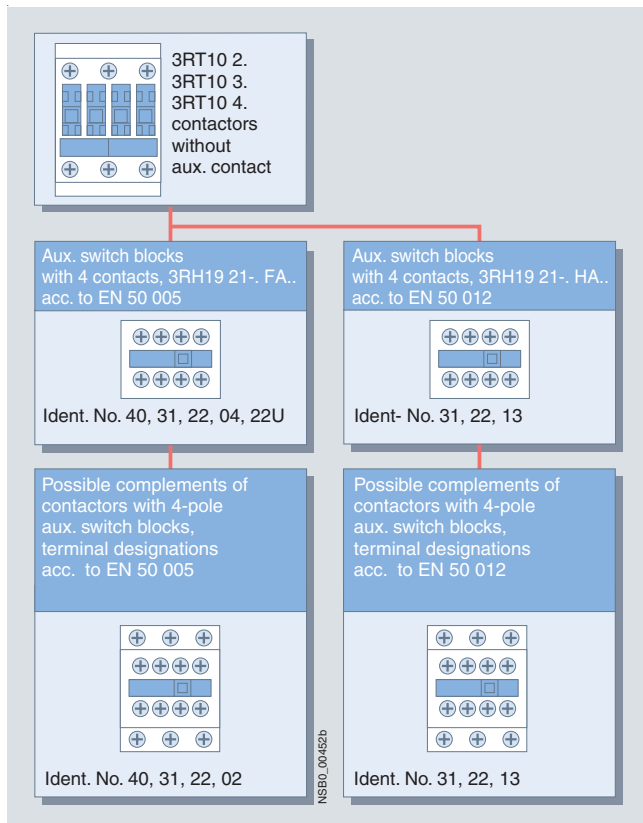

A diverse range of auxiliary switch blocks is available for various applications. The contactors themselves have no integrated conducting path.

The auxiliary switch variants are uniform for the contactors of size S0 to S12.

One 4-pole or up to four single-pole auxiliary switch blocks (screw or Cage Clamp terminals) can be snapped on. When the contactors are switched on, the NC contacts are opened first and then the NO contacts are closed.

The terminal designations of the single-pole auxiliary switch locks are comprised of identification numbers (location identifiers) on the basic unit and of function numbers on the auxiliary switch blocks.

Also available are 2-pole auxiliary switch blocks (screw terminals) for cable entry from above or below in the design of a quad block (feeder auxiliary switch).

If the installation space is limited in depth, 2-pole auxiliary switch blocks (screw or Cage Clamp terminals) can be attached laterally for use on the left or on the right.

The auxiliary switch blocks attached to the front can be disassembled with the help of a centrally arranged release lever; the laterally attached auxiliary switch blocks are easy to remove by pressing on the checkered surfaces.

The terminal designation of the individual auxiliary switch blocks corresponds to EN 50005 or EN 50012, that of the complete contactor with auxiliary switch block 2 NO + 2 NC corresponds to EN 50012.

The laterally attachable auxiliary switch blocks according to EN 50012 can be used only when no 4-pole auxiliary switch blocks are snapped onto the front. If single-pole auxiliary switch blocks are used in addition, the location identifiers on the contactor must be noted.

Two enclosed and 2 standard contacts are available with the 3RH19 21-FE22 solid-state compatible auxiliary switch block, which can be attached to the front. The 3RH19 21-2DE11 laterally mountable auxiliary switch block contains 2 enclosed contacts (1 NO + 1 NC). The enclosed contacts are suitable in particular for switching small voltages and currents (hard gold-plated contacts) and for operation in dusty atmospheres. The NC auxiliary contacts are mirror contacts.

Sizes S0 and S2

A maximum of 4 auxiliary contacts can be attached; the auxiliary switch blocks used can be of any version. For reasons of symmetry, when two 2-pole laterally mountable auxiliary switch blocks are used, one block must be attached on the right and one on the left.

More auxiliary contacts are permissible with size S2 under certain conditions (please ask).

For 4-pole contactors see 3RT13 and 3RT15.

Size S3 to S12

A maximum of 8 auxiliary contacts can be attached; please note the following:

- Of these 8 auxiliary contacts, there must be no more than 4 NC contacts
- Ensure the symmetry of laterally mounted auxiliary switch blocks

For 4-pole contactors see 3RT13 and 3RT15.

3RT, 3TB, 3TF Contactors for Switching Motors

3RT10 contactors, 3-pole, 3 ... 250 kW

Technical specifications

SIRIUS controls are climate-proof and are suitable and tested for use worldwide.

If the devices are used in ambient conditions which deviate from common industrial conditions (EN 60721-3-3 "Stationary Use,

Weather-Protected"), the manufacturer must be consulted about possible restrictions with regard to the reliability and endurance of the device and possible protective measures.

Contactors	Type Size	3RT1 S00 ... S12	
Rated data of the auxiliary contacts			
Acc. to IEC 60947-5-1/EN 60947-5-1 (VDE 0660 Part 200) The data apply to integrated auxiliary contacts and contacts in the auxiliary switch blocks for contactor sizes S00 to S12 ¹⁾			
Rated insulation voltage U_i (degree of pollution 3)	V	690	
For 3RH19 21-. laterally mountable auxiliary switch blocks	V	Max. 500	
Continuous thermal current I_{th} = Rated operational current I_e/AC-12	A	10	
AC load			
Rated operational current I_e/AC-15/AC-14			
• For rated operational voltage U_e			
	24 V	A	6
	110 V	A	6
	125 V	A	6
	220 V	A	6
	230 V	A	6
	380 V	A	3
	400 V	A	3
	500 V	A	2
	660 V ²⁾	A	1
	690 V ²⁾	A	1
DC load			
Rated operational current I_e/DC-12			
• For rated operational voltage U_e			
	24 V	A	10
	60 V	A	6
	110 V	A	3
	125 V	A	2
	220 V	A	1
	440 V	A	0.3
	600 V ²⁾	A	0.15
Rated operational current I_e/DC-13			
• For rated operational voltage U_e			
	24 V	A	10 ¹⁾
	60 V	A	2
	110 V	A	1
	125 V	A	0.9
	220 V	A	0.3
	440 V	A	0.14
	600 V ²⁾	A	0.1
Contact reliability at 17 V, 1 mA acc. to EN 60947-5-4		Frequency of contact faults < 10^{-8} i. e. < 1 fault per 100 million operating cycles	

Endurance of the auxiliary contacts

It is assumed that the operating mechanisms are switched randomly, i. e. not synchronized with the phase angle of the supply system. The contact endurance is mainly dependent on the breaking current.

The characteristic curves apply to:

- Integrated auxiliary contacts on 3RT10
- Auxiliary switch blocks 3RH19 11, 3RH19 21 for contactors of size S00 to S12

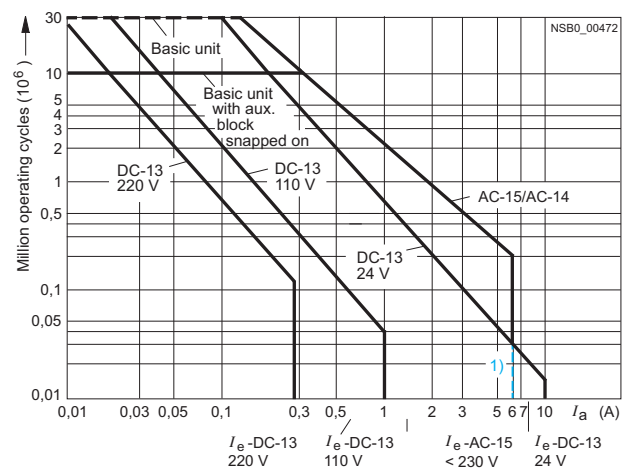

¹⁾ Snap-on auxiliary switch blocks for size S00 and laterally mountable auxiliary switch blocks for S0 to S12: 6 A.

²⁾ Up to 500 V switching capacity for laterally mountable auxiliary switch blocks.

3RT, 3TB, 3TF Contactors for Switching Motors

3RT10 contactors, 3-pole, 3 ... 250 kW

Endurance of the main contacts

The characteristic curves show the contact endurance of the contactors when switching resistive and inductive AC loads (AC-1/AC-3) depending on the breaking current and rated operational voltage. It is assumed that the operating mechanisms are switched randomly, i. e. not synchronized with the phase angle of the supply system.

The rated operational current I_e complies with utilization category AC-4 (breaking six times the rated operational current) and is intended for a contact endurance of at least 200 000 operating cycles.

If a shorter endurance is sufficient, the rated operational current $I_e/AC-4$ can be increased.

If the contacts are used for **mixed operation**, i. e. normal switching (breaking the rated operational current according to utilization category AC-3) in combination with intermittent inching (breaking several times the rated operational current according to utilization category AC-4), the contact endurance can be calculated approximately from the following equation:

$$X = \frac{A}{1 + \frac{C}{100} \left(\frac{A}{B} - 1 \right)}$$

Characters in the equation:

- X Contact endurance for mixed operation in operating cycles
- A Contact endurance for normal operation ($I_a = I_e$) in operating cycles
- B Contact endurance for inching ($I_a = \text{multiple of } I_e$) in operating cycles
- C Inching operations as a percentage of total switching operations

Diagram legend:

P_N = Rated power for squirrel-cage motors at 400 V

I_a = Breaking current

I_e = Rated operational current

Size S00

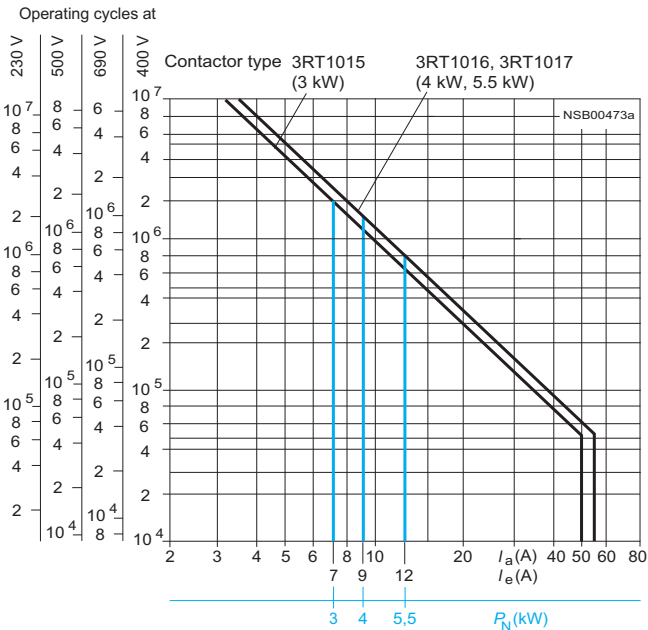

Size S0

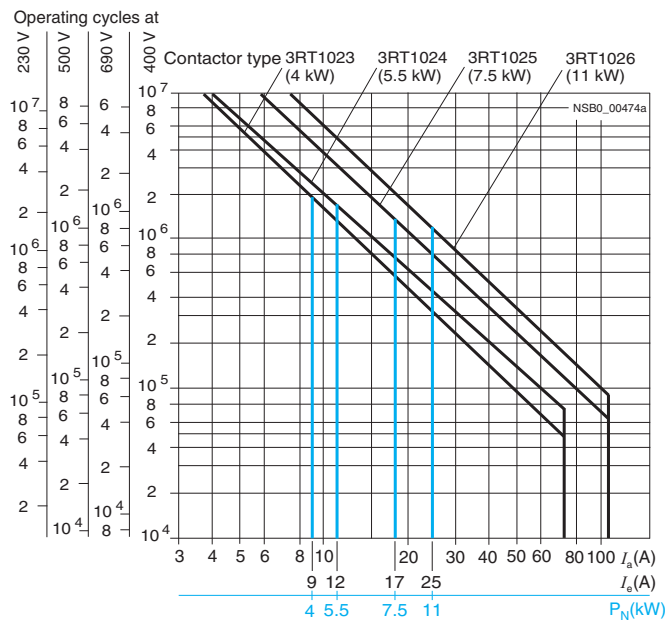

3RT, 3TB, 3TF Contactors for Switching Motors

3RT10 contactors, 3-pole, 3 ... 250 kW

Endurance of the main contacts

Size S2

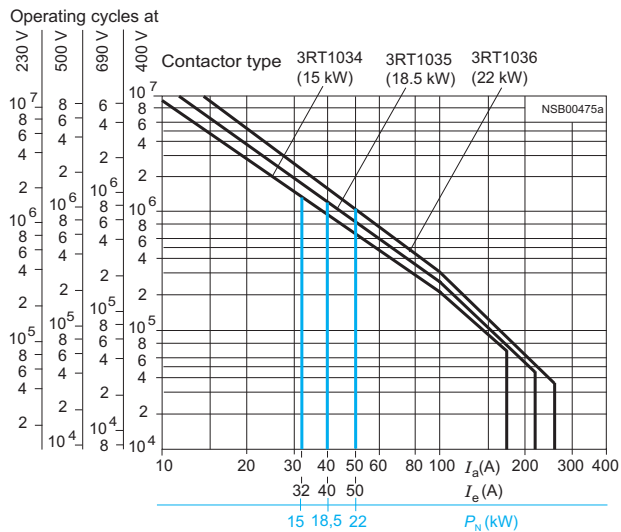

Size S3

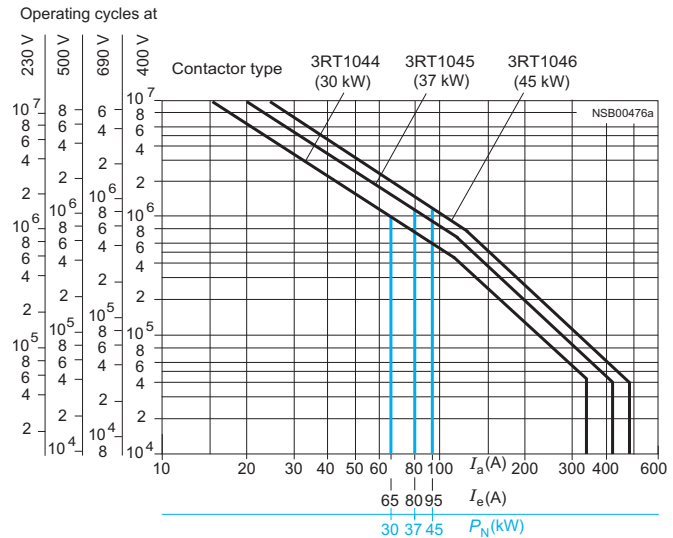

Sizes S6 to S12

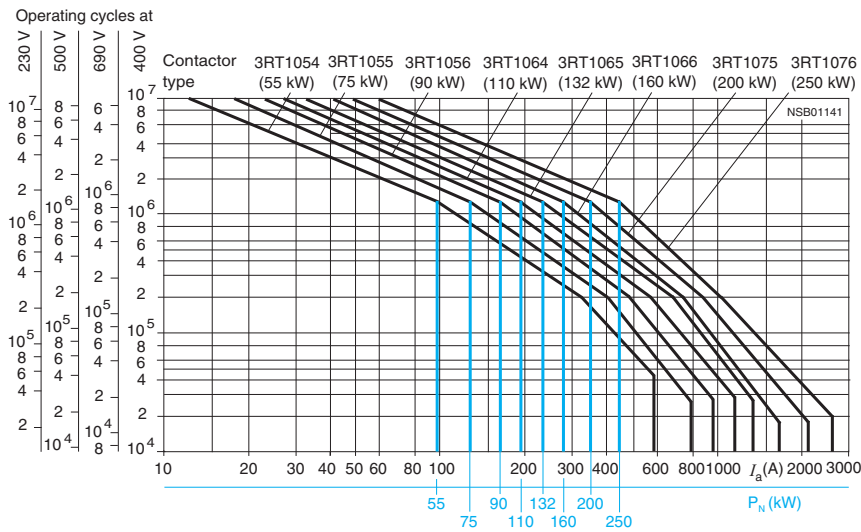

3RT12 vacuum contactors Sizes S10 and S12

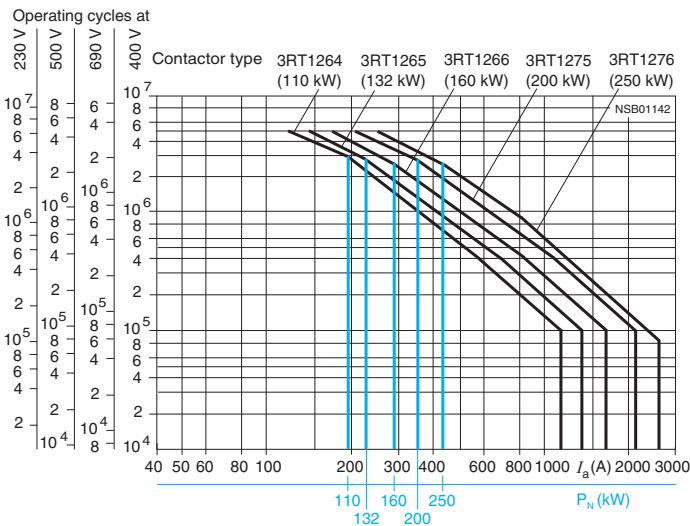

Diagram legend:



P_N = Rated power for squirrel-cage motors at 400 V

I_a = Breaking current

I_e = Rated operational current

3RT, 3TB, 3TF Contactors for Switching Motors

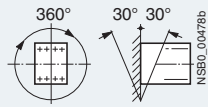
3RT10 contactors, 3-pole, 3 ... 250 kW

Contactor	Type Size	3RT10 1. S00	
General data			
Permissible mounting position The contactors are designed for operation on a vertical mounting surface.	<ul style="list-style-type: none"> AC and DC operation 		
Upright mounting position:	<ul style="list-style-type: none"> AC operation DC operation 	 Special version required. Standard version	
Mechanical endurance	<ul style="list-style-type: none"> Basic units Basic unit with snap-on auxiliary switch block Solid-state compatible auxiliary switch block 	Operating cycles	30 million 10 million 5 million
Electrical endurance			
Rated insulation voltage U_i (degree of pollution 3)		V	690
Rated impulse withstand voltage U_{imp}		kV	6
Protective separation between the coil and the main contacts acc. to EN 60947-1, Appendix N		V	400
Mirror contacts	<ul style="list-style-type: none"> A mirror contact is an auxiliary NC contact that cannot be closed simultaneously with a NO main contact. No mirror contacts for the solid-state compatible auxiliary switch blocks 	<ul style="list-style-type: none"> 3RT10 1., 3RT13 1. (removable auxiliary switch block) 3RT10 1., 3RT13 1. (non-removable auxiliary switch block) 3RH19 11-.NF.. 	Yes, this applies to both the basic unit as well as to between the basic unit and the mounted auxiliary switch block acc. to EN 60947-4-1, Appendix F. Yes, acc. to EN 60947-4-1, Appendix F, SUVA
Ambient temperature	<ul style="list-style-type: none"> During operation During storage 	°C	-25 ... +60 -55 ... +80
Degree of protection acc. to EN 60947-1, Appendix C			IP20, coil assembly IP40
Touch protection acc. to EN 50274			Finger-safe
Shock resistance rectangular pulse	<ul style="list-style-type: none"> AC operation DC operation 	g/ms g/ms	7/5 and 4.2/10 7/5 and 4.2/10
Shock resistance sine pulse	<ul style="list-style-type: none"> AC operation DC operation 	g/ms g/ms	9.8/5 and 5.9/10 9.8/5 and 5.9/10
Conductor cross-sections			
Short-circuit protection for contactors without overload relays			
<p>For short-circuit protection for contactors with overload relays see "Protection Equipment --> Overload Relays" For short-circuit protection for fuseless load feeders see "Load Feeders, Motor Starters and Soft Starters -> 3RA Fuseless Load Feeders".</p>			
Main circuit	<ul style="list-style-type: none"> Fuse links gL/gG LV HRC 3NA, DIAZED 5SB, NEOZED 5SE acc. to IEC 60947-4-1/EN 60947-4-1 Miniature circuit breakers (up to 230 V) with C characteristic Short-circuit current 1 kA, type of coordination "1" 	<ul style="list-style-type: none"> Type of coordination "1" Type of coordination "2" Weld-free³⁾ 	A 35 A 20 A 10 A 10
Auxiliary circuit	<ul style="list-style-type: none"> Fuse links gL/gG DIAZED 5SB, NEOZED 5SE (weld-free protection $I_k \geq 1$ kA) Miniature circuit breakers up to 230 V with C characteristic Short-circuit current $I_k < 400$ A 		A 10 A 6

¹⁾ For endurance of the main contacts see page 3/18.

²⁾ For conductor cross-sections see page 3/23.

³⁾ Test conditions according to IEC 60947-4-1.

3RT, 3TB, 3TF Contactors for Switching Motors

3RT10 contactors, 3-pole, 3 ... 250 kW

Contactors	Type Size	3RT10 1. S00	
Control			
Magnetic coil operating range			
• AC operation	50 Hz 60 Hz	0.8 ... 1.1 x U_s 0.85 ... 1.1 x U_s	
• DC operation	Up to 50 °C Up to 60 °C	0.8 ... 1.1 x U_s 0.85 ... 1.1 x U_s	
Power consumption of the magnetic coils (when coil is cold and 1.0 x U_s)			
AC operation, 50/60 Hz			
• Standard version	- Closing - P.f. - Closed - P.f.	VA VA	27/24.3 0.8/0.75 4.4/3.4 0.27/0.27
• AC operation, 50 Hz, USA/Canada	- Closing - P.f. for closing - Closed - P.f. for closed	VA VA	26.4 0.81 4.7 0.26
• AC operation, 60 Hz, USA/Canada	- Closing - P.f. for closing - Closed - P.f. for closed	VA VA	31.7 0.77 5.1 0.27
• DC operation	Closing = Closed	W	3.3
Permissible residual current of the electronics (with 0 signal)			
• AC operation			< 3 mA x (230 V/ U_s), the 3RT19 16-1GA00 additional load module is recommended for a higher residual current
• DC operation			< 10 mA x (24 V/ U_s), the 3RT19 16-1GA00 additional load module is recommended for a higher residual current
Operating times¹⁾			
Total break time = Opening delay + Arcing time			
• AC operation at 0.8 ... 1.1 x U_s	- Closing delay - Opening delay	ms ms	8 ... 35 4 ... 30
• DC operation at 0.85 ... 1.1 x U_s	- Closing delay - Opening delay	ms ms	25 ... 100 7 ... 10
• Arcing time		ms	10 ... 15
Operating times for 1.0 x U_s¹⁾			
• AC operation	- Closing delay - Opening delay	ms ms	10 ... 25 5 ... 30
• DC operation	- Closing delay - Opening delay	ms ms	30 ... 50 7 ... 9

¹⁾ The OFF-delay of the NO contact and the ON-delay of the NC contact are increased if the contactor coils are attenuated against voltage peaks (noise suppression diode 6 to 10 times; diode assemblies 2 to 6 times, varistor +2 to 5 ms).

Contactors	Type Size	3RT10 15 S00	3RT10 16 S00	3RT10 17 S00
Main circuit				
AC capacity				
Utilization category AC-1				
Switching resistive loads				
• Rated operational current I_e	At 40 °C up to 690 V At 60 °C up to 690 V	A A	18 16	22 20
• Rated power for AC loads ¹⁾ P.f. = 0.95 (at 60 °C)	230 V 400 V 500 V 690 V	kW kW kW kW	6.3 11 13.8 19	7.5 13 17 22
• Minimum conductor cross-section for loads with I_e	At 40 °C At 60 °C	mm ² mm ²	2.5 2.5	2.5 2.5
Utilization categories AC-2 and AC-3				
• Rated operational currents I_e	Up to 400 V 440 V 500 V 690 V	A A A A	7 7 5 4	9 9 6.5 5.2
• Rated power for slipping or squirrel-cage motors at 50 and 60 Hz	At 230 V 400 V 500 V 690 V	kW kW kW kW	2.2 3 3.5 4	3 4 4.5 5.5
Thermal load capacity	10 s current ²⁾	A	56	72

¹⁾ Industrial furnaces and electric heaters with resistance heating, etc. (increased power consumption on heating up has been taken into account).

²⁾ According to IEC 60947-4-1.

For rated values for various start-up conditions see "Protection Equipment -> Overload Relays".

3RT, 3TB, 3TF Contactors for Switching Motors

3RT10 contactors, 3-pole, 3 ... 250 kW

Contactor	Type Size		3RT10 15 S00	3RT10 16 S00	3RT10 17 S00
Main circuit					
AC capacity					
Power loss per conducting path					
		At $I_e/AC-3$ W	0.42	0.7	1.24
Utilization category AC-4 (for $I_a = 6 \times I_e$)¹⁾					
• Rated operational current I_e	Up to 400 V	A	6.5	8.5	8.5
• Rated power for squirrel-cage motors with 50 Hz and 60 Hz	Up to 400 V	kW	3	4	4
• The following applies to a contact endurance of about 200000 operating cycles:					
- Rated operational currents I_e	Up to 400 V	A	2.6	4.1	4.1
	690 V	A	1.8	3.3	3.3
- Rated power for squirrel-cage motors with 50 Hz and 60 Hz	At 230 V	kW	0.67	1.1	1.1
	400 V	kW	1.15	2	2
	500 V	kW	1.45	2	2
	690 V	kW	1.15	2.5	2.5
Utilization category AC-5a					
Switching gas discharge lamps, inductive ballast					
per main current path at 230 V					
• Uncorrected, rated power per lamp/rated operational current per lamp					
	L 18 W/0.37 A	Units	54	59	59
	L 36 W/0.43 A	Units	46	51	51
	L 58 W/0.67 A	Units	29	32	32
	L 80 W/0.79 A	Units	25	27	27
• DUO switching (two-lamp)	L 18 W/0.22 A	Units	90 (≅ 2 x 90 lamps)	100 (≅ 2 x 100 lamps)	100 (≅ 2 x 100 lamps)
	L 36 W/0.42 A	Units	47 (≅ 2 x 47 lamps)	52 (≅ 2 x 52 lamps)	52 (≅ 2 x 52 lamps)
	L 58 W/0.63 A	Units	31 (≅ 2 x 31 lamps)	34 (≅ 2 x 34 lamps)	34 (≅ 2 x 34 lamps)
	L 80 W/0.87 A	Units	22 (≅ 2 x 22 lamps)	25 (≅ 2 x 25 lamps)	25 (≅ 2 x 25 lamps)
Switching gas discharge lamps with correction					
per main current path at 230 V					
• Shunt compensation with inductive ballast, rated power per lamp/capacitance/ rated operational current per lamp					
	L 18 W/4.5 μF/0.11 A	Units	17	22	22
	L 36 W/4.5 μF/0.21 A	Units	16	22	22
	L 58 W/7.0 μF/0.32 A	Units	10	14	14
	L 80 W/7.0 μF/0.49 A	Units	6	9	9
• With solid-state ballast ²⁾ single lamp	L 18 W/6.8 μF/0.10 A	Units	49	63	63
	L 36 W/6.8 μF/0.18 A	Units	27	35	35
	L 58 W/10 μF/0.29 A	Units	16	23	23
	L 80 W/10 μF/0.43 A	Units	11	14	14
• With solid-state ballast ²⁾ two-lamp	L 18 W/10 μF/0.18 A	Units	27 (≅ 2 x 27 lamps)	35 (≅ 2 x 35 lamps)	35 (≅ 2 x 35 lamps)
	L 36 W/10 μF/0.35 A	Units	14 (≅ 2 x 14 lamps)	18 (≅ 2 x 18 lamps)	18 (≅ 2 x 18 lamps)
	L 58 W/22 μF/0.52 A	Units	9 (≅ 2 x 9 lamps)	12 (≅ 2 x 12 lamps)	12 (≅ 2 x 12 lamps)
	L 80 W/22 μF/0.86 A	Units	5 (≅ 2 x 5 lamps)	7 (≅ 2 x 7 lamps)	7 (≅ 2 x 7 lamps)
Utilization category AC-5b, switching incandescent lamps					
per main current path at 230/220 V					
Utilization category AC-6a					
switching AC transformers					
• Rated operational current I_e					
- For inrush current n = 20	Up to 400 V	A	3.6	5.1	7.2
- For inrush current n = 30	Up to 400 V	A	2.4	3.3	5.1
• Rated power P					
- For inrush current n = 20	At 230 V	kVA	1.4	2	2.9
	400 V	kVA	2.5	3.5	5
	500 V	kVA	3.3	4.6	6.2
	690 V	kVA	4.3	6	8.6
- For inrush current n = 30	At 230 V	kVA	1	1.3	2
	400 V	kVA	1.6	2.3	3.5
	500 V	kVA	2.2	3.1	4.6
	690 V	kVA	2.9	4	6

For deviating inrush current factors x, the power must be recalculated as follows:
 $P_x = P_{n,30} \cdot 30/x$

1) The data only apply to 3RT15 16 and 3RT15 17 (2 NO + 2 NC) up to a rated operational voltage of 400 V.

2) Depending on the electronic ballast used, higher lamp numbers are also possible.

3RT, 3TB, 3TF Contactors for Switching Motors

3RT10 contactors, 3-pole, 3 ... 250 kW

Contactors	Type Size	3RT10 15 S00	3RT10 16 S00	3RT10 17 S00
Main circuit				
<i>Load rating with DC</i>				
Utilization category DC-1				
Switching resistive loads ($L/R \leq 1$ ms)				
• Rated operational current I_e (at 60 °C)				
- 1 conducting path		Up to 24 V A 60 V A 110 V A 220 V A 440 V A 600 V A	15 15 1.5 0.6 0.42 0.42	20 20 2.1 0.8 0.6 0.6
- 2 conducting paths in series		Up to 24 V A 60 V A 110 V A 220 V A 440 V A 600 V A	15 15 8.4 1.2 1.6 0.5	20 20 12 1.6 0.8 0.7
- 3 conducting paths in series		Up to 24 V A 60 V A 110 V A 220 V A 440 V A 600 V A	15 15 15 15 0.9 0.7	20 20 20 20 1.3 1
Utilization category DC-3 and DC-5				
Shunt-wound and series-wound motors ($L/R \leq 15$ ms)				
• Rated operational current I_e (at 60 °C)				
- 1 conducting path		Up to 24 V A 60 V A 110 V A 220 V A 440 V A 600 V A	15 0.35 0.1 -- -- --	20 0.5 0.15 -- -- --
- 2 conducting paths in series		Up to 24 V A 60 V A 110 V A 220 V A 440 V A 600 V A	15 3.5 0.25 -- -- --	20 5 0.35 -- -- --
- 3 conducting paths in series		Up to 24 V A 60 V A 110 V A 220 V A 440 V A 600 V A	15 15 15 1.2 0.14 0.14	20 20 20 1.5 0.2 0.2

Switching frequency**Switching frequency z** in operating cycles/hour

• Contactors without overload relay	No-load switching frequency AC	h^{-1}	10000
	No-load switching frequency DC	h^{-1}	10000
Dependence of the switching frequency z' on the operational current I' and operational voltage U' : $z' = z \cdot (I_e/I') \cdot (400 V/U')^{1.5} \cdot 1/h$	Rated operation		
	AC-1 (AC/DC)	h^{-1}	1000
	AC-2 (AC/DC)	h^{-1}	750
	AC-3 (AC/DC)	h^{-1}	750
	AC-4 (AC/DC)	h^{-1}	250
• Contactors with overload relays (mean value)		h^{-1}	15

Conductor cross-sections**Main and auxiliary conductors:**

(1 or 2 conductors can be connected) For standard screwdriver size 2 and Pozidriv 2	• Solid	mm ²	
	• Finely stranded with end sleeve	mm ²	
	• Solid or stranded, AWG cables	AWG	
	• Terminal screw	M3	
	- Tightening torque	Nm	

 **Screw terminals**

2 x (0.5 ... 1.5) ¹⁾ ; 2 x (0.75 ... 2.5) ¹⁾ acc. to IEC 60947; max. 2 x (1 ... 4)
2 x (0.5 ... 1.5) ¹⁾ ; 2 x (0.75 ... 2.5) ¹⁾
2 x (20 ... 16) ¹⁾ ; 2 x (18 ... 14) ¹⁾ ; 1 x 12
0.8 ... 1.2 (7 ... 10.3 lb.in)

**Main and auxiliary conductors;
coil terminals:**

(1 or 2 conductors can be connected)	• Solid	mm ²	
	• Finely stranded with end sleeve	mm ²	
	• Finely stranded without end sleeve	mm ²	
	• AWG cables, solid or stranded	AWG	

 **Cage Clamp terminals**



2 x (0.25 ... 2.5)
2 x (0.25 ... 1.5)
2 x (0.25 ... 2.5)
2 x (24 ... 14)

For tools for opening Cage Clamp terminals see Catalog LV 1, Chapter 3, Accessories and Spare Parts.
Maximum external diameter of the conductor insulation: 3.6 mm.
For conductor cross-sections ≤ 1 mm² an "insulation stop" must be used, see Catalog LV 1, Chapter 3, "Accessories and Spare Parts".

¹⁾ If two different conductor cross-sections are connected to one clamping point, both cross-sections must lie in the range specified. If identical cross-sections are used, this restriction does not apply.

3RT, 3TB, 3TF Contactors for Switching Motors

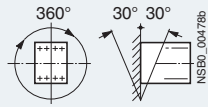
3RT10 contactors, 3-pole, 3 ... 250 kW

Contactor	Type Size	3RT10 23 S0	3RT10 24 S0	3RT10 25 S0	3RT10 26 S0
General data					
Permissible mounting position The contactors are designed for operation on a vertical mounting surface.	<ul style="list-style-type: none"> AC and DC operation 				
Upright mounting position:	<ul style="list-style-type: none"> AC operation DC operation 	 Standard version Special version required, also applies to 3RT10 2...K.40. coupling relays.			
Mechanical endurance	<ul style="list-style-type: none"> Basic units Basic unit with snap-on auxiliary switch block Solid-state compatible auxiliary switch block 	Operating cycles	10 million	10 million	5 million
Electrical endurance			1)		
Rated insulation voltage U_i (degree of pollution 3)		V	690		
Rated impulse withstand voltage U_{imp}		kV	6		
Protective separation between the coil and the main contacts (acc. to EN 60947-1, Appendix N)		V	400		
Mirror contacts	<ul style="list-style-type: none"> A mirror contact is an auxiliary NC contact that cannot be closed simultaneously with a NO main contact. 	<ul style="list-style-type: none"> 3RT10 2., 3RT13 2. (removable auxiliary switch block) 3RT10 2., 3RT13 2. (non-removable auxiliary switch block) 	Yes, acc. to EN 60947-4-1, Appendix F	Acc. to SUVA requirements on request	
Permissible ambient temperature	<ul style="list-style-type: none"> During operation During storage 	°C	-25 ... +60	°C	-55 ... +80
Degree of protection acc. to EN 60947-1, Appendix C			IP20, coil assembly IP20		
Touch protection acc. to EN 50274			Finger-safe		
Shock resistance rectangular pulse	<ul style="list-style-type: none"> AC operation DC operation 	g/ms	8.2/5 and 4.9/10	g/ms	10/5 and 7.5/10
Shock resistance sine pulse	<ul style="list-style-type: none"> AC operation DC operation 	g/ms	12.5/5 and 7.8/10	g/ms	15/5 and 10/10
Conductor cross-sections			2)		
Short-circuit protection for contactors without overload relays					
Main circuit	<ul style="list-style-type: none"> Fuse links gL/gG LV HRC 3NA, DIAZED 5SB, NEOZED 5SE acc. to IEC 60947-4-1/ EN 60947-4-1 Miniature circuit breakers with C characteristic (short-circuit current 3 kA, type of coordination "1") 	<ul style="list-style-type: none"> Type of coordination "1" Type of coordination "2" Weld-free³⁾ 	A	63	100
			A	25	35
			A	10	16
			A	25	32
Auxiliary circuit	<ul style="list-style-type: none"> Fuse links gL/gG DIAZED 5SB, NEOZED 5SE (weld-free protection at $I_k \geq 1$ kA) Miniature circuit breaker with C characteristic (short-circuit current $I_k < 400$ A) 		A	10	
			A	10	

1) For endurance of the main contacts see page 3/18.

2) For conductor cross-sections see page 3/28.

3) Test conditions according to IEC 60947-4-1.

3RT, 3TB, 3TF Contactors for Switching Motors

3RT10 contactors, 3-pole, 3 ... 250 kW

Contactors	Type Size	3RT10 2. S0	
Control			
Magnetic coil operating range	AC/DC	0.8 ... 1.1 x U_s	
Power consumption of the magnetic coils (when coil is cold and 1.0 x U_s)			
• AC operation, 50 Hz, standard version	- Closing	VA	61
	- P.f.		0.82
	- Closed	VA	7.8
	- P.f.		0.24
• AC operation, 50/60 Hz, standard version	- Closing	VA	64/63
	- P.f.		0.72/0.74
	- Closed	VA	8.4/6.8
	- P.f.		0.24/0.28
	- Closing	VA	61
	- P.f.		0.82
• AC operation, 50 Hz, USA/Canada	- Closed	VA	7.8
	- P.f.		0.24
• AC operation, 60 Hz, USA/Canada	- Closing	VA	69
	- P.f.		0.76
	- Closed	VA	7.5
	- P.f.		0.28
• DC operation	Closing = Closed	W	5.4
Permissible residual current of the electronics (with 0 signal)			
	• AC operation	mA	< 6 mA x (230 V/ U_s)
	• DC operation	mA	< 16 mA x (24 V/ U_s)
Operating times for 0.8 ... 1.1 x U_s¹⁾			
Total break time = Opening delay + Arcing time			
• AC operation	- Closing delay	ms	8 ... 44
	- Opening delay	ms	4 ... 20
• DC operation	- Closing delay	ms	50 ... 170
	- Opening delay	ms	13.5 ... 15.5
• Arcing time		ms	10
Operating times for 1.0 x U_s¹⁾			
• AC operation	- Closing delay	ms	10 ... 17
	- Opening delay	ms	4 ... 20
• DC operation	- Closing delay	ms	55 ... 85
	- Opening delay	ms	14 ... 15.5

¹⁾ The OFF-delay of the NO contact and the ON-delay of the NC contact are increased if the contactor coils are attenuated against voltage peaks (varistor +2 ms to 5 ms, diode assembly: 2 to 6 times).

Contactors	Type Size	3RT10 23 S0		3RT10 24 S0	3RT10 25 S0	3RT10 26 S0
Main circuit						
AC capacity						
Utilization category AC-1						
Switching resistive loads						
• Rated operational current I_e	At 40 °C up to 690 V	A	40			
	At 60 °C up to 690 V	A	35			
• Rated power for AC loads ¹⁾ P.f. = 0.95 (at 60 °C)	230 V	kW	13.3			
	400 V	kW	23			
	500 V	kW	29			
	690 V	kW	40			
• Minimum conductor cross-section for loads with I_e	At 40 °C	mm ²	10			
	At 60 °C	mm ²	10			
Utilization category AC-2 and AC-3						
• Rated operational currents I_e	Up to 400 V	A	9	12	17	25
	440 V	A	9	12	17	22
	500 V	A	6.5	12	17	18
	690 V	A	5.2	9	13	13
• Rated power for slipping or squirrel-cage motors at 50 Hz and 60 Hz	At 110 V	kW	1.1	1.5	2.2	3
	230 V	kW	3	3	4	5.5
	400 V	kW	4	5.5	7.5	11
	500 V	kW	4.5	7.5	10	11
	660 V/690 V	kW	5.5	7.5	11	11
Thermal load capacity	10 s current ²⁾	A	80	110	150	200
Power loss per conducting path	At I_e /AC-3	W	0.4	0.5	0.9	1.6

¹⁾ Industrial furnaces and electric heaters with resistance heating, etc. (increased power consumption on heating up has been taken into account).

²⁾ According to IEC 60947-4-1.
For rated values for various start-up conditions see "Protection Equipment -> Overload Relays".

3RT, 3TB, 3TF Contactors for Switching Motors

3RT10 contactors, 3-pole, 3 ... 250 kW

Contactors	Type Size		3RT10 23 S0	3RT10 24 S0	3RT10 25 S0	3RT10 26 S0
Main circuit						
AC capacity						
Utilization category AC-4 (for $I_a = 6 \times I_e$)						
• Rated operational current I_e	Up to 400 V	A	8.5	12.5	15.5	15.5
• Rated power for squirrel-cage motors with 50 Hz and 60 Hz	At 400 V	kW	4	5.5	7.5	7.5
• The following applies to a contact endurance of about 200000 operating cycles:						
- Rated operational currents I_e	Up to 400 V	A	4.1	5.5	7.7	9
	690 V	A	3.3	5.5	7.7	9
- Rated power for squirrel-cage motors with 50 Hz and 60 Hz	At 110 V	kW	0.5	0.73	1	1.2
	230 V	kW	1.1	1.5	2	2.5
	400 V	kW	2	2.6	3.5	4.4
	500 V	kW	2	3.3	4.6	5.6
	690 V	kW	2.5	4.6	6	7.7
Utilization category AC-5a						
Switching gas discharge lamps, inductive ballast						
Per main current path at 230 V ¹⁾						
• Rated power per lamp/rated operational current per lamp						
- Uncorrected	L 18 W/0.37 A	Units	108			
	L 36 W/0.43 A	Units	93			
	L 58 W/0.67 A	Units	59			
	L 80 W/0.79 A	Units	50			
- DUO switching (two-lamp)	L 18 W/0.22 A	Units	181 (≅ 2 x 181 lamps)			
	L 36 W/0.42 A	Units	95 (≅ 2 x 95 lamps)			
	L 58 W/0.63 A	Units	63 (≅ 2 x 63 lamps)			
	L 80 W/0.87 A	Units	45 (≅ 2 x 45 lamps)			
Switching gas discharge lamps with correction						
Per main current path at 230 V						
• Rated power per lamp/capacitance/rated operational current per lamp						
- Shunt compensation with inductive ballast	L 18 W/4.5 μF/0.11 A	Units	37		41	61
	L 36 W/4.5 μF/0.21 A	Units	30		30	51
	L 58 W/7.0 μF/0.32 A	Units	20		20	33
	L 80 W/7.0 μF/0.49 A	Units	13		13	22
- With solid-state ballast ²⁾ single lamp	L 18 W/6.8 μF/0.10 A	Units	105		119	175
	L 36 W/6.8 μF/0.18 A	Units	58		66	97
	L 58 W/10 μF/0.29 A	Units	36		41	60
	L 80 W/10 μF/0.43 A	Units	24		27	40
- With solid-state ballast ²⁾ two-lamp	L 18 W/10 μF/0.18 A	Units	58 (≅ 2 x 58 lamps)		66 (≅ 2 x 66 l.)	97 (≅ 2 x 97 l.)
	L 36 W/10 μF/0.35 A	Units	30 (≅ 2 x 30 lamps)		34 (≅ 2 x 34 l.)	50 (≅ 2 x 50 l.)
	L 58 W/22 μF/0.52 A	Units	20 (≅ 2 x 20 lamps)		22 (≅ 2 x 22 l.)	33 (≅ 2 x 33 l.)
	L 80 W/22 μF/0.86 A	Units	12 (≅ 2 x 12 lamps)		13 (≅ 2 x 13 l.)	20 (≅ 2 x 20 l.)
Utilization category AC-5b, switching incandescent lamps						
per main current path at 230/220 V						
		kW	2.8		3.2	4.7
Utilization category AC-6a						
switching AC transformers						
• Rated operational current I_e						
- For inrush current n = 20	Up to 400 V	A	11.4			20.2
- For inrush current n = 30	Up to 400 V	A	7.6			13.5
• Rating P						
- For inrush current n = 20	At 230 V	kVA	4.5			8
	400 V	kVA	7.9			13.9
	500 V	kVA	9.9			15.5
	690 V	kVA	13.6			15.5
- For inrush current n = 30	At 230 V	kVA	3			5.4
	400 V	kVA	5.2			9.3
	500 V	kVA	6.6			11.7
	690 V	kVA	9.1			15.5
For deviating inrush current factors x, the power must be recalculated as follows: $P_x = P_{n30} \cdot 30/x$						
Utilization category AC-6b,						
switching low-inductance (low-loss, metallized dielectric) AC capacitors						
• Rated operational currents I_e	Up to 400 V	A	5.8			10.8
• Rated power for single capacitors or banks of capacitors (minimum inductance of 6 μH between capacitors connected in parallel) at 50 Hz, 60 Hz and	At 230 V	kvar	2.5			4
	400 V	kvar	4			7.5
	500 V	kvar	4			7.5
	690 V	kvar	4			7.5

¹⁾ For $I_e/AC-1 = 35$ A (60 °C) and the corresponding minimum conductor cross-section 10 mm².

²⁾ Depending on the electronic ballast used, higher lamp numbers are also possible.





3RT, 3TB, 3TF Contactors for Switching Motors

3RT10 contactors, 3-pole, 3 ... 250 kW

Contactor	Type Size	3RT10 23 S0	3RT10 24 S0	3RT10 25 S0	3RT10 26 S0
Main circuit					
<i>Load rating with DC</i>					
Utilization category DC-1					
Switching resistive loads ($L/R \leq 1$ ms)					
• Rated operational current I_g (at 60 °C)					
- 1 conducting path		Up to 24 V A	35		
		60 V A	20		
		110 V A	4.5		
		220 V A	1		
		440 V A	0.4		
		600 V A	0.25		
- 2 conducting paths in series		Up to 24 V A	35		
		60 V A	35		
		110 V A	35		
		220 V A	5		
		440 V A	1		
		600 V A	0.8		
- 3 conducting paths in series		Up to 24 V A	35		
		60 V A	35		
		110 V A	35		
		220 V A	35		
		440 V A	2.9		
		600 V A	1.4		
Utilization category DC-3 and DC-5					
Shunt-wound and series-wound motors ($L/R \leq 15$ ms)					
• Rated operational current I_g (at 60 °C)					
- 1 conducting path		Up to 24 V A	20		
		60 V A	5		
		110 V A	2.5		
		220 V A	1		
		440 V A	0.09		
		600 V A	0.06		
- 2 conducting paths in series		Up to 24 V A	35		
		60 V A	35		
		110 V A	15		
		220 V A	3		
		440 V A	0.27		
		600 V A	0.16		
- 3 conducting paths in series		Up to 24 V A	35		
		60 V A	35		
		110 V A	35		
		220 V A	10		
		440 V A	0.6		
		600 V A	0.6		
Switching frequency					
Switching frequency z in operating cycles/hour					
• Contactors without overload relays					
	No-load switching frequency AC	h^{-1}	5000		
	No-load switching frequency DC	h^{-1}	1500		
Dependence of the switching frequency z' on the operational current I' and operational voltage U' :					
$z' = z \cdot (I_g/I') \cdot (400 V/U')^{1.5} \cdot 1/h$					
	AC-1 (AC/DC)	h^{-1}	1000		
	AC-2 (AC/DC)	h^{-1}	1000		750
	AC-3 (AC/DC)	h^{-1}	1000		750
	AC-4 (AC/DC)	h^{-1}	300		250
• Contactors with overload relays (mean value)					
		h^{-1}	15		

3RT, 3TB, 3TF Contactors for Switching Motors

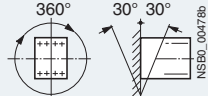
3RT10 contactors, 3-pole, 3 ... 250 kW

Contactors	Type Size	3RT10 23 S0	3RT10 24 S0	3RT10 25 S0	3RT10 26 S0
Conductor cross-sections (1 or 2 conductors connectable)					
Main conductors		 Screw terminals			
Conductor cross-section		mm ² 2 x (1 ... 2.5) ¹⁾ ; 2 x (2.5 ... 6) ¹⁾ acc. to IEC 60947; max. 1 x 10			
• Solid		mm ² 2 x (1 ... 2.5) ¹⁾ ; 2 x (2.5 ... 6) ¹⁾			
• Finely stranded with end sleeve		mm ² 2 x (1 ... 2.5) ¹⁾ ; 2 x (2.5 ... 6) ¹⁾			
• AWG cables, solid		AWG 2 x (16 ... 12)			
• AWG cables, solid or stranded		AWG 2 x (14 ... 10)			
• AWG cables, stranded		AWG 1 x 8			
• Terminal screws		M4 (Pozidriv size 2)			
- Tightening torque		Nm 2 ... 2.5 (18 ... 22 lb.in)			
Auxiliary conductors		 Cage Clamp terminals			
Conductor cross-section		mm ² 2 x (0.5 ... 1.5) ¹⁾ ; 2 x (0.75 ... 2.5) ¹⁾ acc. to IEC 60947; max. 2 x (0.75 ... 4)			
• Solid		mm ² 2 x (0.5 ... 1.5) ¹⁾ ; 2 x (0.75 ... 2.5) ¹⁾			
• Finely stranded with end sleeve		mm ² 2 x (0.5 ... 1.5) ¹⁾ ; 2 x (0.75 ... 2.5) ¹⁾			
• solid or stranded AWG (2 x)		AWG 2 x (20 ... 16) ¹⁾ ; 2 x (18 ... 14) ¹⁾ ; 1 x 12			
• Terminal screws		M3			
- Tightening torque		Nm 0.8 ... 1.2 (7 ... 10.3 lb.in)			
Auxiliary conductors		 Cage Clamp terminals			
• Solid		mm ² 2 x (0.25 ... 2.5)			
• Finely stranded with end sleeve		mm ² 2 x (0.25 ... 1.5)			
• Finely stranded without end sleeve		mm ² 2 x (0.25 ... 2.5)			
• AWG cables, solid or stranded		AWG 2 x (24 ... 14)			
1) If two different conductor cross-sections are connected to one clamping point, both cross-sections must lie in the range specified. If identical cross-sections are used, this restriction does not apply.					
Contactors	Type Size	3RT10 34 S2	3RT10 35 S2	3RT10 36 S2	
General data					
Permissible mounting position	• AC and DC operation				
The contactors are designed for operation on a vertical mounting surface.		For DC operation and 22.5 ° inclination towards the front, operating range 0.85 ... 1.1 x U _s			
Upright mounting position:	• AC and DC operation				
		Special version required.			
Mechanical endurance	• Basic units	Operating cycles	10 million		
	• Basic unit with snap-on auxiliary switch block		10 million		
	• Solid-state compatible auxiliary switch block		5 million		
Electrical endurance			1)		
Rated insulation voltage U _i (degree of pollution 3)		V	690		
Rated impulse withstand voltage U _{imp}		kV	6		
Protective separation between the coil and the main contacts acc. to EN 60947-1, Appendix N		V	400		
Mirror contacts	• A mirror contact is an auxiliary NC contact that cannot be closed simultaneously with a NO main contact.	- 3RT10 3.., 3RT13 3. (removable auxiliary switch block) - 3RT10 3.., 3RT13 3. (non-removable auxiliary switch block)	Yes, acc. to EN 60947-4-1, Appendix F Acc. to SUVA requirements on request.		
Permissible ambient temperature	• During operation	°C	-25 ... +60		
	• During storage	°C	-55 ... +80		
Degree of protection acc. to EN 60947-1, Appendix C			IP20 (terminal compartment IP00), AC coil assembly IP40, DC coil assembly IP30 Finger-safe		
Touch protection acc. to EN 50274			Finger-safe		
Shock resistance					
• Rectangular pulse	AC and DC operation	g/ms	10/5 and 5/10		
• Sine pulse	AC and DC operation	g/ms	15/5 and 8/10		
Conductor cross-sections			2)		

1) For endurance of the main contacts see page 3/19.

2) For conductor cross-sections see page 3/32.

3RT, 3TB, 3TF Contactors for Switching Motors

3RT10 contactors, 3-pole, 3 ... 250 kW

Contactors	Type Size		3RT10 34 S2	3RT10 35 S2	3RT10 36 S2
Short-circuit protection for contactors without overload relays					
			For short-circuit protection for contactors with overload relays see "Protection Equipment --> Overload Relays". For short-circuit protection for fuseless load feeders see "Load Feeders, Motor Starters and Soft Starters -> 3RA Fuseless Load Feeders".		
Main circuit					
Fuse links, gL/gG					
LV HRC 3NA, DIAZED 5SB, NEOZED 5SE					
acc. to IEC 60947-4-1/ EN 60947-4-1					
	• Type of coordination "1"	A	125	125	160
	• Type of coordination "2"	A	63	63	80
	• Weld-free ¹⁾	A	16	16	50
Auxiliary circuit					
• Fuse links gL/gG	DIAZED 5SB, NEOZED 5SE (weld-free protection at $I_k \geq 1$ kA)	A	10		
• Miniature circuit breakers with C characteristic (short-circuit current $I_k \leq 400$ A)		A	10		
Control					
Magnetic coil operating range		AC/DC	0.8 ... 1.1 x U_s		
Power consumption of the magnetic coils (when coil is cold and 1.0 x U_s)					
• AC operation, 50 Hz, standard version	- Closing	VA	104	145	
	- P.f.		0.78	0.79	
	- Closed	VA	9.7	12.5	
	- P.f.		0.42	0.36	
• AC operation, 50/60 Hz, standard version	- Closing	VA	127/113	170/155	
	- P.f.		0.73/0.69	0.76/0.72	
	- Closed	VA	11.3/9.5	15/11.8	
	- P.f.		0.41/0.42	0.35/0.38	
• AC operation, 50 Hz, USA/Canada	- Closing	VA	108	150	
	- P.f.		0.76	0.77	
	- Closed	VA	9.6	12.5	
	- P.f.		0.42	0.35	
• AC operation, 60 Hz, USA/Canada	- Closing	VA	120	166	
	- P.f.		0.7	0.71	
	- Closed	VA	10.1	12.6	
	- P.f.		0.42	0.37	
• DC operation	Closing = Closed	W	13.3	13.3	
Permissible residual current of the electronics (with 0 signal)					
	• AC operation	mA	< 12 mA x (230 V/ U_s)		< 18 mA x (230 V/ U_s)
	• DC operation	mA	< 38 mA x (24 V/ U_s)		< 38 mA x (24 V/ U_s)
Operating times for 0.8 ... 1.1 x U_s²⁾ (Total break time = Opening delay + Arcing time)					
• AC operation	- Closing delay	ms	11 ... 30	10 ... 24	
	- Opening delay	ms	7 ... 10	7 ... 10	
• DC operation	- Closing delay	ms	50 ... 95	60 ... 100	
	- Opening delay	ms	20 ... 30	20 ... 25	
• Arcing time		ms	10	10	
Operating times for 1.0 x U_s²⁾					
• AC operation	- Closing delay	ms	13 ... 22	12 ... 20	
	- Opening delay	ms	7 ... 10	7 ... 10	
• DC operation	- Closing delay	ms	60 ... 75	70 ... 85	
	- Opening delay	ms	20 ... 30	20 ... 25	

¹⁾ Test conditions according to IEC 60947-4-1.

²⁾ The OFF-delay of the NO contact and the ON-delay of the NC contact are increased if the contactor coils are attenuated against voltage peaks (varistor +2 ms to 5 ms, diode assembly: 2 to 6 times).

3RT, 3TB, 3TF Contactors for Switching Motors

3RT10 contactors, 3-pole, 3 ... 250 kW

Contactors	Type Size		3RT10 34 S2	3RT10 35 S2	3RT10 36 S2
Main circuit					
AC capacity					
Utilization category AC-1					
Switching resistive loads					
• Rated operational currents I_e	At 40 °C up to 690 V	A	50	60	60
	At 60 °C up to 690 V	A	45	55	55
• Rated power for AC loads ¹⁾	230 V	kW	18	22	22
P.f. = 0.95 (at 60 °C)	400 V	kW	31	38	38
	500 V	kW	39	46	46
	690 V	kW	54	66	66
• Minimum conductor cross-section for loads with I_e	At 40 °C	mm ²	16	16	16
	At 60 °C	mm ²	10	16	16
Utilization category AC-2 and AC-3					
• Rated operational currents I_e	Up to 500 V	A	32	40	50
	690 V	A	20	24	24
• Rated power for slipping or squirrel-cage motors at 50 and 60 Hz	230 V	kW	7.5	11	15
	400 V	kW	15	18.5	22
	500 V	kW	18.5	22	30
	690 V	kW	18.5	22	22
Thermal load capacity					
	10 s current ²⁾	A	320	400	400
Power loss per conducting path					
	At $I_e/AC-3$	W	1.8	2.6	5
Utilization category AC-4 (for $I_a = 6 \times I_e$)					
• Rated operational current I_e	Up to 400 V	A	29	35	41
• Rated power for squirrel-cage motors with 50 Hz and 60 Hz	At 400 V	kW	15	18.5	22
• The following applies to a contact endurance of about 200000 operating cycles:					
- Rated operational currents I_e	Up to 400 V	A	15.6	18.5	24
	690 V	A	15.6	18.5	24
- Rated power for squirrel-cage motors with 50 Hz and 60 Hz	230 V	kW	4.7	5.4	7.3
	400 V	kW	8.2	9.5	12.6
	500 V	kW	9.8	11.8	15.8
	690 V	kW	13	15.5	21.8
Utilization category AC-5a					
Switching gas discharge lamps, inductive ballast					
Per main current path at 230 V					
• Uncorrected, rated power per lamp/rated operational current per lamp	L 18 W/0.37 A	Units	135	162	162
	L 36 W/0.43 A	Units	116	139	139
	L 58 W/0.67 A	Units	74	89	89
	L 80 W/0.79 A	Units	63	75	75
• DUO switching (two-lamp)	L 18 W/0.22 A	Units	227 (≅ 2 x 227 lamps)	272 (≅ 2 x 272 lamps)	272 (≅ 2 x 272 lamps)
	L 36 W/0.42 A	Units	119 (≅ 2 x 119 lamps)	142 (≅ 2 x 142 lamps)	142 (≅ 2 x 142 lamps)
	L 58 W/0.63 A	Units	79 (≅ 2 x 79 lamps)	95 (≅ 2 x 95 lamps)	95 (≅ 2 x 95 lamps)
	L 80 W/0.87 A	Units	57 (≅ 2 x 57 lamps)	68 (≅ 2 x 68 lamps)	68 (≅ 2 x 68 lamps)
Switching gas discharge lamps with correction					
Per main current path at 230 V					
• Shunt compensation with inductive ballast, rated power per lamp/capacitance/rated operational current per lamp	L 18 W/4.5 µF/0.11 A	Units	78	98	123
	L 36 W/4.5 µF/0.21 A	Units	78	98	123
	L 58 W/7 µF/0.32 A	Units	50	63	79
	L 80 W/7 µF/0.49 A	Units	50	63	73
• With solid-state ballast ³⁾ single lamp	L 18 W/6.8 µF/0.10 A	Units	224	280	350
	L 36 W/6.8 µF/0.18 A	Units	124	155	194
	L 58 W/10 µF/0.29 A	Units	77	96	120
	L 80 W/10 µF/0.43 A	Units	52	65	81
• With solid-state ballast ³⁾ two-lamp	L 18 W/10 µF/0.18 A	Units	124 (≅ 2 x 124 lamps)	155 (≅ 2 x 155 lamps)	194 (≅ 2 x 194 lamps)
	L 36 W/10 µF/0.35 A	Units	64 (≅ 2 x 64 lamps)	80 (≅ 2 x 80 lamps)	100 (≅ 2 x 100 lamps)
	L 58 W/22 µF/0.52 A	Units	43 (≅ 2 x 43 lamps)	54 (≅ 2 x 54 lamps)	67 (≅ 2 x 67 lamps)
	L 80 W/22 µF/0.86 A	Units	26 (≅ 2 x 26 lamps)	32 (≅ 2 x 32 lamps)	40 (≅ 2 x 40 lamps)

1) Industrial furnaces and electric heaters with resistance heating, etc. (increased power consumption on heating up has been taken into account).

2) According to IEC 60947-4-1.
For rated values for various start-up conditions see "Protection Equipment --> Overload Relays".

3) Depending on the electronic ballast used, higher lamp numbers are also possible.

3RT, 3TB, 3TF Contactors for Switching Motors





3RT10 contactors, 3-pole, 3 ... 250 kW

Contactors	Type Size		3RT10 34 S2	3RT10 35 S2	3RT10 36 S2
Main circuit					
<i>AC capacity</i>					
Utilization category AC-5b Switching incandescent lamps		kW	6.0	7.6	9.5
Per main current path at 230/220 V					
Utilization category AC-6a switching AC transformers					
• Rated operational current I_e					
- For inrush current n = 20	Up to 400 V	A	31	36.5	43.2
- For inrush current n = 30	Up to 400 V	A	20.7	24.3	28.8
• Rating P					
- For inrush current n = 20	At 230 V	kVA	12.3	14.5	17.2
	400 V	kVA	21.5	25.3	29.9
	500 V	kVA	26.8	31.6	37.4
	690 V	kVA	23.9	28.7	28.7
- For inrush current n = 30	230 V	kVA	8.2	9.7	11.5
	400 V	kVA	14.3	16.8	20
	500 V	kVA	17.9	21	24.9
	690 V	kVA	23.9	28.7	28.7
For deviating inrush current factors x, the power must be recalculated as follows. $P_x = P_{n30} \cdot 30/x$					
Utilization category AC-6b Switching low-inductance (low-loss, metallized dielectric) AC capacitors					
Ambient temperature 40 °C					
• Rated operational currents I_e	Up to 400 V	A	29	36	36
• Rated power for single capacitors or banks of capacitors (minimum inductance of 20 µH between capacitors connected in parallel) at 50 Hz, 60 Hz and	At 230 V	kvar	12	15	15
	400 V	kvar	20	25	25
	525 V	kvar	25	33	33
	690 V	kvar	20	25	25
<i>Load rating with DC</i>					
Utilization category DC-1 Switching resistive loads ($L/R < 1$ ms)					
• Rated operational current I_e (at 60 °C)					
- 1 conducting path	Up to 24 V	A	45	55	55
	60 V	A	20	23	23
	110 V	A	4.5	4.5	4.5
	220 V	A	2	2	2
	440 V	A	0.4	0.4	0.4
	600 V	A	0.25	0.25	0.25
- 2 conducting paths in series	Up to 24 V	A	45	55	55
	60 V	A	45	45	45
	110 V	A	45	45	45
	220 V	A	5	5	5
	440 V	A	1	1	1
	600 V	A	0.8	0.8	0.8
- 3 conducting paths in series	Up to 24 V	A	45	55	55
	60 V	A	45	55	55
	110 V	A	45	55	55
	220 V	A	45	45	45
	440 V	A	2.9	2.9	2.9
	600 V	A	1.4	1.4	1.4
Utilization category DC-3 and DC-5 Shunt-wound and series-wound motors ($L/R \leq 15$ ms)					
• Rated operational current I_e (at 60 °C)					
- 1 conducting path	Up to 24 V	A	35	35	35
	60 V	A	6	6	6
	110 V	A	2.5	2.5	2.5
	220 V	A	2	2	2
	440 V	A	0.1	0.1	0.1
	600 V	A	0.06	0.06	0.06
- 2 conducting paths in series	Up to 24 V	A	45	55	55
	60 V	A	45	45	45
	110 V	A	25	25	25
	220 V	A	5	5	5
	440 V	A	0.27	0.27	0.27
	600 V	A	0.16	0.16	0.16
- 3 conducting paths in series	Up to 24 V	A	45	55	55
	60 V	A	45	55	55
	110 V	A	45	55	55
	220 V	A	25	25	25
	440 V	A	0.6	0.6	0.6
	600 V	A	0.6	0.6	0.6

3RT, 3TB, 3TF Contactors for Switching Motors

3RT10 contactors, 3-pole, 3 ... 250 kW

Contactors	Type Size	3RT10 34 S2	3RT10 35 S2	3RT10 36 S2
Switching frequency				
Switching frequency z in operating cycles/hour				
• Contactors without overload relays	No-load switching frequency AC	h ⁻¹	5000	5000
	No-load switching frequency DC	h ⁻¹	1500	1500
Dependence of the switching frequency z' on the operational current I' and operational voltage U': $z' = z \cdot (I_e/I') \cdot (400 V/U')^{1.5} \cdot 1/h$	AC-1 (AC/DC)	h ⁻¹	1200	1200
	AC-2 (AC/DC)	h ⁻¹	750	600
	AC-3 (AC/DC)	h ⁻¹	1000	1000
	AC-4 (AC/DC)	h ⁻¹	250	300
• Contactors with overload relays (mean value)		h ⁻¹	15	15

Contactors	Type Size	3RT10 3. S2		
Conductor cross-sections (1 or 2 conductors connectable)				
Front clamping point connected 	Main conductors: With box terminal		 Screw terminals	
	<ul style="list-style-type: none"> Finely stranded with end sleeve Finely stranded without end sleeve Stranded Solid Ribbon cable conductors (number x width x thickness) AWG cables, solid or stranded 	mm ² mm ² mm ² mm ² mm AWG	0.75 ... 25 0.75 ... 25 0.75 ... 35 0.75 ... 16 6 x 9 x 0.8 18 ... 2	
Rear clamping point connected 	<ul style="list-style-type: none"> Finely stranded with end sleeve Finely stranded without end sleeve Stranded Solid Ribbon cable conductors (number x width x thickness) AWG cables, solid or stranded 	mm ² mm ² mm ² mm ² mm AWG	0.75 ... 25 0.75 ... 25 0.75 ... 35 0.75 ... 16 6 x 9 x 0.8 18 ... 2	
	<ul style="list-style-type: none"> Finely stranded with end sleeve Finely stranded without end sleeve Stranded Solid Ribbon cable conductors (number x width x thickness) AWG cables, solid or stranded Terminal screw - Tightening torque 	mm ² mm ² mm ² mm ² mm AWG Nm	2 x (0.75 ... 16) 2 x (0.75 ... 16) 2 x (0.75 ... 25) 2 x (0.75 ... 16) 2 x (6 x 9 x 0.8) 2 x (18 ... 2) M6 (Pozidriv size 2) 3 ... 4.5 (27 ... 40 lb.in)	
Both clamping points connected 	Auxiliary conductors:		 Cage Clamp terminals	
	<ul style="list-style-type: none"> Solid Finely stranded with end sleeve Finely stranded without end sleeve AWG cables, solid or stranded Terminal screw - Tightening torque 	mm ² mm ² mm ² AWG Nm	2 x (0.5 ... 1.5) ¹⁾ ; 2 x (0.75 ... 2.5) ¹⁾ acc. to IEC 60947; max. 2 x (0.75 ... 4) 2 x (0.5 ... 1.5) ¹⁾ ; 2 x (0.75 ... 2.5) ¹⁾ 2 x (20 ... 16) ¹⁾ ; 2 x (18 ... 14) ¹⁾ ; 1 x 12 M3 0.8 ... 1.2 (7 ... 10.3 lb.in)	
	Auxiliary conductors:			
	<ul style="list-style-type: none"> Solid Finely stranded with end sleeve Finely stranded without end sleeve AWG cables, solid or stranded 	mm ² mm ² mm ²	2 x (0.25 ... 2.5) 2 x (0.25 ... 1.5) 2 x (0.25 ... 2.5) 2 x (24 ... 14)	



For tools for opening Cage Clamp terminals see Catalog LV 1, Chapter 3, Accessories and Spare Parts.

Maximum external diameter of the conductor insulation: 3.6 mm. For conductor cross-sections ≤ 1 mm² an "insulation stop" must be used, see Catalog LV 1, Chapter 3, "Accessories and Spare Parts".

¹⁾ If two different conductor cross-sections are connected to one clamping point, both cross-sections must lie in the range specified. If identical cross-sections are used, this restriction does not apply.

3RT, 3TB, 3TF Contactors for Switching Motors

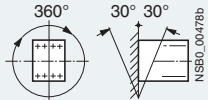
3RT10 contactors, 3-pole, 3 ... 250 kW

Contactors	Type Size		3RT10 44 S3	3RT10 45 S3	3RT10 46 S3
General data					
Permissible mounting position The contactors are designed for operation on a vertical mounting surface.	• AC and DC operation		 <p>For DC operation and 22.5° inclination towards the front, operating range 0.85 ... 1.1 x U_s</p>		
Upright mounting position:	• AC operation		 <p>Special version required.</p>		
	• DC operation		--		
Mechanical endurance	• Basic units	Operating cycles	10 million		
	• Basic unit with snap-on auxiliary switch block		10 million		
	• Solid-state compatible auxiliary switch block		5 million		
Electrical endurance			1)		
Rated insulation voltage U_i (degree of pollution 3)		V	1000		
Rated impulse withstand voltage U_{imp}		kV	6		
Protective separation between the coil and the main contacts acc. to EN 60947-1, Appendix N		V	690		
Mirror contacts			Yes, acc. to EN 60947-4-1, Appendix F		
• A mirror contact is an auxiliary NC contact that cannot be closed simultaneously with a NO main contact.	<ul style="list-style-type: none"> - 3RT10 4., 3RT13 4., 3RT14 4. (removable auxiliary switch block) - 3RT10 4., 3RT13 4., 3RT14 4. (non-removable auxiliary switch block) 		Acc. to Swiss regulations (SUVA) on request.		
Permissible ambient temperature	• During operation	°C	-25 ... +60		
	• During storage	°C	-55 ... +80		
Degree of protection acc. to EN 60947-1, Appendix C			IP20 (terminal compartment IP00), AC coil assembly IP40, DC coil assembly IP30 Finger-safe		
Touch protection acc. to EN 50274			Finger-safe		
Shock resistance					
• Rectangular pulse	AC and DC operation	g/ms	6.8/5 and 4/10		
• Sine pulse	AC and DC operation	g/ms	10.6/5 and 6.2/10		
Conductor cross-sections			2)		
Short-circuit protection for contactors without overload relays					
Main circuit			For short-circuit protection for contactors with overload relays see "Protection Equipment --> Overload Relays". For short-circuit protection for fuseless load feeders see "Load Feeders, Motor Starters and Soft Starters -> 3RA Fuseless Load Feeders".		
• Fuse links gL/gG LV HRC 3NA, DIAZED 5SB, NEOZED 5SE acc. to IEC 60947-4-1/ EN 60947-4-1					
	- Type of coordination "1"	A	250	250	
	- Type of coordination "2"	A	125	160	
	- Weld-free ³⁾	A	63	100	
Auxiliary circuit					
• Fuse links gL/gG DIAZED 5SB, NEOZED 5SE (weld-free protection at $I_k \geq 1$ kA)		A	10		
• Miniature circuit breakers with C characteristic (short-circuit current $I_k < 400$ A)		A	10		

¹⁾ For endurance of the main contacts see page 3/19.

²⁾ For conductor cross-sections see page 3/37.

³⁾ Test conditions according to IEC 60947-4-1.

3RT, 3TB, 3TF Contactors for Switching Motors

3RT10 contactors, 3-pole, 3 ... 250 kW

Contactors	Type Size		3RT10 44 S3	3RT10 45 S3	3RT10 46 S3
Control					
Magnetic coil operating range	AC/DC		0.8 ... 1.1 x U_s		
Power consumption of the magnetic coils (when coil is cold and 1.0 x U_s)					
• AC operation, 50 Hz, standard version	- Closing	VA	218	270	
	- P.f.		0.61	0.68	
• AC operation, 50/60 Hz, standard version	- Closing	VA	247/211	298/274	
	- P.f.		0.62/0.57	0.7/0.62	
• AC operation, 50 Hz, USA/Canada	- Closing	VA	218	270	
	- P.f.		0.61	0.68	
• AC operation, 60 Hz, USA/Canada	- Closing	VA	232	300	
	- P.f.		0.55	0.52	
• DC operation	- Closing	VA	21	22	
	- P.f.		0.26	0.27	
• DC operation	- Closing	VA	21	22	
	- P.f.		0.26	0.27	
• DC operation	- Closing	VA	20	21	
	- P.f.		0.28	0.29	
• DC operation	- Closing	VA	15	15	
	- P.f.		0.28	0.29	
Permissible residual current of the electronics (with 0 signal)					
• AC operation			< 25 mA x (230 V/ U_s)		
• DC operation			< 43 mA x (24 V/ U_s)		
Operating times for 0.8 ... 1.1 x U_s¹⁾					
Total break time = Opening delay + Arcing time					
• AC operation	- Closing delay	ms	16 ... 57	17 ... 90	
	- Opening delay	ms	10 ... 19	10 ... 25	
• DC operation	- Closing delay	ms	90 ... 230	90 ... 230	
	- Opening delay	ms	14 ... 20	14 ... 20	
• Arcing time		ms	10 ... 15	10 ... 15	
Operating times for 1.0 x U_s¹⁾					
• AC operation	- Closing delay	ms	18 ... 34	18 ... 30	
	- Opening delay	ms	11 ... 18	11 ... 23	
• DC operation	- Closing delay	ms	100 ... 120	100 ... 120	
	- Opening delay	ms	16 ... 20	16 ... 20	
Main circuit					
AC capacity					
Utilization category AC-1					
Switching resistive loads					
• Rated operational currents I_e	At 40 °C up to 690 V A	1000 V A	100	120	120
		1000 V A	50	60	70
	At 60 °C up to 690 V A	1000 V A	90	100	100
		1000 V A	40	50	60
• Rated output of AC loads ²⁾ P.f. = 0.95 (at 60 °C)	At 230 V kW	34	38	38	
	400 V kW	59	66	66	
	500 V kW	74	82	82	
	690 V kW	102	114	114	
	1000 V kW	66	82	98	
• Minimum conductor cross-section for loads with I_e	At 40 °C mm ²	35	50	50	
	At 60 °C mm ²	35	35	35	
Utilization categories AC-2 and AC-3					
• Rated operational currents I_e	Up to 500 V A	65	80	95	
	690 V A	47	58	58	
	1000 V A	25	30	30	
• Rated power of slipping or squirrel-cage motors at 50 and 60 Hz	At 230 V kW	18.5	22	22	
	400 V kW	30	37	45	
	500 V kW	37	45	55	
	690 V kW	45	55	55	
	1000 V kW	30	37	37	
Thermal load capacity					
	10 s current ³⁾ A		600	760	760
Power loss per conducting path					
	At I_e /AC-3 W		4.6	7.7	10.8

1) The OFF-delay of the NO contact and the ON-delay of the NC contact are increased if the contactor coils are attenuated against voltage peaks (varistor +2 ms to 5 ms, diode assembly: 2 to 6 times).

2) Industrial furnaces and electric heaters with resistance heating, etc. (increased power consumption on heating up has been taken into account).

3) According to IEC 60947-4-1.
For rated values for various start-up conditions see "Protection Equipment --> Overload Relays".

3RT, 3TB, 3TF Contactors for Switching Motors

3RT10 contactors, 3-pole, 3 ... 250 kW

Contactors	Type Size		3RT10 44 S3	3RT10 45 S3	3RT10 46 S3
Main circuit					
AC capacity					
Utilization category AC-4 (for $I_a = 6 \times I_e$)					
• Rated operational current I_e	Up to 400 V	A	55	66	80
• Rated power for squirrel-cage motors with 50 Hz and 60 Hz	At 400 V	kW	30	37	45
• The following applies to a contact endurance of about 200000 operating cycles:					
- Rated operational currents I_e	Up to 400 V	A	28	34	42
	690 V	A	28	34	42
	1000 V	A	20	23	23
- Rated power for squirrel-cage motors with 50 Hz and 60 Hz	At 230 V	kW	8.7	10.4	12
	400 V	kW	15.1	17.9	22
	500 V	kW	18.4	22.4	27
	690 V	kW	25.4	30.9	38
	1000 V	kW	22	30	30
Utilization category AC-5a					
Switching gas discharge lamps, inductive ballast					
Per main current path at 230 V					
• Uncorrected, rated power per lamp/rated operational current per lamp					
	L 18 W/0.37 A	Units	270	324	
	L 36 W/0.43 A	Units	232	279	
	L 58 W/0.67 A	Units	149	179	
	L 80 W/0.79 A	Units	126	151	
• DUO switching (two-lamp)					
	L 18 W/0.21 A	Units	454 (≅ 2 x 454 lamps)	545 (≅ 2 x 545 lamps)	
	L 36 W/0.42 A	Units	238 (≅ 2 x 238 lamps)	285 (≅ 2 x 285 lamps)	
	L 58 W/0.63 A	Units	158 (≅ 2 x 158 lamps)	190 (≅ 2 x 190 lamps)	
	L 80 W/0.87 A	Units	114 (≅ 2 x 114 lamps)	137 (≅ 2 x 137 lamps)	
Switching gas discharge lamps with correction					
Per main current path at 230 V					
• Shunt compensation with inductive ballast, rated power per lamp/capacitance/rated operational current per lamp					
	L 18 W/4.5 μF/0.11 A	Units	160	197	234
	L 36 W/4.5 μF/0.21 A	Units	160	197	234
	L 58 W/7 μF/0.32 A	Units	103	127	150
	L 80 W/7 μF/0.49 A	Units	103	126	146
• With solid-state ballast ¹⁾ single lamp					
	L 18 W/6.8 μF/0.10 A	Units	455	560	665
	L 36 W/6.8 μF/0.18 A	Units	253	311	369
	L 58 W/10 μF/0.29 A	Units	156	193	229
	L 80 W/10 μF/0.43 A	Units	105	130	154
• With solid-state ballast ¹⁾ two-lamp					
	L 18 W/10 μF/0.18 A	Units	253 (≅ 2 x 253 lamps)	311 (≅ 2 x 311 lamps)	369 (≅ 2 x 369 lamps)
	L 36 W/10 μF/0.35 A	Units	130 (≅ 2 x 130 lamps)	160 (≅ 2 x 160 lamps)	190 (≅ 2 x 190 lamps)
	L 58 W/22 μF/0.52 A	Units	88 (≅ 2 x 88 lamps)	108 (≅ 2 x 108 lamps)	128 (≅ 2 x 128 lamps)
	L 80 W/22 μF/0.86 A	Units	52 (≅ 2 x 52 lamps)	65 (≅ 2 x 65 lamps)	77 (≅ 2 x 77 lamps)
Utilization category AC-5b					
Switching incandescent lamps					
Per main current path at 230/220 V					
		kW	12.3	15.2	18.1

¹⁾ Depending on the electronic ballast used, higher lamp numbers are also possible.

3RT, 3TB, 3TF Contactors for Switching Motors





3RT10 contactors, 3-pole, 3 ... 250 kW

Contactors	Type Size	3RT10 44 S3	3RT10 45 S3	3RT10 46 S3
Main circuit				
AC capacity				
Utilization category AC-6a switching AC transformers				
• Rated operational current I_g (60 °C)				
- For inrush current n = 20	Up to 400 V A	63.5	80	84.4
	Up to 690 V A	47	58	58
- For inrush current n = 30	Up to 400 V A	42.3	56.3	56.3
	Up to 690 V A	42.3	56.3	56.3
• Rating P				
- For inrush current n = 20	230 V kVA	25.3	31.9	33.6
	400 V kVA	43.9	55.4	58
	500 V kVA	54.9	69.3	73.1
	690 V kVA	56.2	69.3	69.3
- For inrush current n = 30	230 V kVA	16.8	22.4	22.4
	400 V kVA	29.3	39	39
	500 V kVA	36.6	48.7	48.7
	690 V kVA	50.3	67.3	67.3
For deviating inrush current factors x, the power must be recalculated as follows. $P_x = P_{n30} \cdot 30/x$				
Utilization category AC-6b Switching low-inductance (low-loss, metallized dielectric) AC capacitors				
• Rated operational current I_g (60 °C)	Up to 400 V A	57	72	
• Rated power for single capacitors or banks of capacitors (minimum inductance of 6 µH between capacitors connected in parallel) at 50 Hz, 60 Hz and	At 230 V kvar	24	29	
	400 V kvar	40	50	
	525 V kvar	50	65	
	690 V kvar	40	50	
Load rating with DC				
Utilization category DC-1 Switching resistive load ($L/R \leq 1$ ms)				
• Rated operational current I_g (60 °C)				
- 1 conducting path	Up to 24 V A	90	100	100
	60 V A	23	60	60
	110 V A	4.5	9	9
	220 V A	1	2	2
	440 V A	0.4	0.6	0.6
	600 V A	0.26	0.4	0.4
- 2 conducting paths in series	Up to 24 V A	90	100	100
	60 V A	90	100	100
	110 V A	90	100	100
	220 V A	5	10	10
	440 V A	1	1.8	1.8
	600 V A	0.8	1	1
- 3 conducting paths in series	Up to 24 V A	90	100	100
	60 V A	90	100	100
	110 V A	90	100	100
	220 V A	70	80	80
	440 V A	2.9	1.8	4.5
	600 V A	1.4	1	2.6
Utilization category DC-3 and DC-5 Shunt-wound and series-wound motors ($L/R \leq 15$ ms)				
• Rated operational current I_g (60 °C)				
- 1 conducting path	Up to 24 V A	40	40	40
	60 V A	6	6.5	6.5
	110 V A	2.5	2.5	2.5
	220 V A	1	1	1
	440 V A	0.15	0.15	0.15
	600 V A	0.06	0.06	0.06
- 2 conducting paths in series	Up to 24 V A	90	100	100
	60 V A	90	100	100
	110 V A	90	100	100
	220 V A	7	7	7
	440 V A	0.42	0.42	0.42
	600 V A	0.16	0.16	0.16
- 3 conducting paths in series	Up to 24 V A	90	100	100
	60 V A	90	100	100
	110 V A	90	100	100
	220 V A	35	35	35
	440 V A	0.8	0.8	0.8
	600 V A	0.35	0.35	0.35

3RT, 3TB, 3TF Contactors for Switching Motors

3RT10 contactors, 3-pole, 3 ... 250 kW

Contactors	Type Size	3RT10 44 S3	3RT10 45 S3	3RT10 46 S3
Main circuit				
Switching frequency				
Switching frequency z in operating cycles/hour				
• Contactors without overload relays	No-load switching frequency AC	h ⁻¹ 5000	5000	5000
	No-load switching frequency DC	h ⁻¹ 1000	1000	1000
Dependence of the switching frequency z' on the operational current I' and operational voltage U':	AC-1 (AC/DC)	h ⁻¹ 1000	900	900
	AC-2 (AC/DC)	h ⁻¹ 400	400	350
	AC-3 (AC/DC)	h ⁻¹ 1000	1000	850
	AC-4 (AC/DC)	h ⁻¹ 300	300	250
• Contactors with overload relays (mean value)		h ⁻¹ 15	15	15

Contactors	Type Size	3RT10 4. S3
Conductor cross-sections (1 or 2 conductors connectable)		
	Main conductors: With box terminal	 Screw terminals
Front clamping point connected 	<ul style="list-style-type: none"> • Finely stranded with end sleeve mm² 2.5 ... 35 • Finely stranded without end sleeve mm² 4 ... 50 • Solid mm² 2.5 ... 16 • Stranded mm² 4 ... 70 • Ribbon cable conductors (number x width x thickness) mm 6 x 9 x 0.8 • AWG cables, solid or stranded AWG 10 ... 2/0 	
Rear clamping point connected 	<ul style="list-style-type: none"> • Finely stranded with end sleeve mm² 2.5 ... 50 • Finely stranded without end sleeve mm² 10 ... 50 • Solid mm² 2.5 ... 16 • Stranded mm² 10 ... 70 • Ribbon cable conductors (number x width x thickness) mm 6 x 9 x 0.8 • AWG cables, solid or stranded AWG 10 ... 2/0 	
Both clamping points connected 	<ul style="list-style-type: none"> • Finely stranded with end sleeve mm² 2 x (2.5 ... 35) • Finely stranded without end sleeve mm² 2 x (4 ... 35) • Solid mm² 2 x (2.5 ... 16) • Stranded mm² 2 x (4 ... 50) • Ribbon cable conductors (number x width x thickness) mm 2 x (6 x 9 x 0.8) • AWG cables, solid or stranded AWG 2 x (10 ... 1/0) • Terminal screw - Tightening torque Nm M6 (hexagon socket, A/F 4) 4 ... 6 (36 ... 53 lb.in) 	
Connection for drilled copper bars ¹⁾	Max. width	mm 10
Without box terminal with cable lugs ²⁾ (1 or 2 conductors can be connected)	<ul style="list-style-type: none"> • Finely stranded with cable lug mm² 10 ... 50³⁾ • Stranded with cable lug mm² 10 ... 70³⁾ • AWG cables, solid or stranded AWG 7 ... 1/0 	
	Auxiliary conductors:	
	• Solid	mm ² 2 x (0.5 ... 1.5) ⁴⁾ ; 2 x (0.75 ... 2.5) ⁴⁾ acc. to IEC 60947; max. 2 x (0.75 ... 4)
	• Finely stranded with end sleeve	mm ² 2 x (0.5 ... 1.5) ⁴⁾ ; 2 x (0.75 ... 2.5) ⁴⁾
	• AWG cables, solid or stranded	AWG 2 x (20 ... 16) ⁴⁾ ; 2 x (18 ... 14) ⁴⁾ ; 1 x 12
	• Terminal screw - Tightening torque	Nm M3 0.8 ... 1.2 (7 ... 10.3 lb.in)
	Auxiliary conductors:	 Cage Clamp terminals
	• Solid	mm ² 2 x (0.25 ... 2.5)
	• Finely stranded with end sleeve	mm ² 2 x (0.25 ... 1.5)
	• Finely stranded without end sleeve	mm ² 2 x (0.25 ... 2.5)
	• AWG cables, solid or stranded	AWG 2 x (24 ... 14)

For tools for opening Cage Clamp terminals see Catalog LV 1, Chapter 3, Accessories and Spare Parts.
Maximum external diameter of the conductor insulation: 3.6 mm.
For conductor cross-sections ≤ 1 mm² an "insulation stop" must be used, see Catalog LV 1, Chapter 3, "Accessories and Spare Parts".

- 1) If bars larger than 12 x 10 mm are connected, a 3RT19 46-4EA1 terminal cover is needed to comply with the phase clearance.
- 2) If conductors larger than 25 mm² are connected, a 3RT19 46-4EA1 terminal cover is needed to comply with the phase clearance.
- 3) Only with crimped cable lugs according to DIN 46234. Cable lug max. 20 mm wide.
- 4) If two different conductor cross-sections are connected to one clamping point, both cross-sections must lie in the range specified. If identical cross-sections are used, this restriction does not apply.

3RT, 3TB, 3TF Contactors for Switching Motors

3RT10 contactors, 3-pole, 3 ... 250 kW

Contactors	Type Size	3RT10 54 S6	3RT10 55 S6	3RT10 56 S6
General data				
Permissible mounting position The contactors are designed for operation on a vertical mounting surface.				
Mechanical endurance	Operating cycles	10 million		
Electrical endurance		1)		
Rated insulation voltage U_i (degree of pollution 3)		V	1000	
Rated impulse withstand voltage U_{imp}		kV	8	
Protective separation between the coil and the main contacts acc. to EN 60947-1, Appendix N		V	690	
Mirror contacts A mirror contact is an auxiliary NC contact that cannot be closed simultaneously with a NO main contact.		Yes, acc. to EN 60947-4-1, Appendix F		
Permissible ambient temperature		°C	-25 ... +60/+55 with AS-Interface	
		°C	-55 ... +80	
Degree of protection acc. to EN 60947-1, Appendix C		IP00/open, coil assembly IP20		
Touch protection acc. to EN 50274		Finger-safe with cover		
Shock resistance				
		g/ms	8.5/5 and 4.2/10	
		g/ms	13.4/5 and 6.5/10	
Conductor cross-sections		2)		
Electromagnetic compatibility (EMC)		3)		
Short-circuit protection				
Main circuit Fuse links, gL/gG LV HRC 3NA, DIAZED 5SB, NEOZED 5SE acc. to IEC 60947-4-1/ EN 60947-4-1			For short-circuit protection for contactors with overload relays see "Protection Equipment --> Overload Relays".	
		A	355	355
		A	315	315
		A	80	160
Auxiliary circuit				
• Fuse links gL/gG DIAZED 5SB, NEOZED 5SE (weld-free protection at $I_k \geq 1$ kA)		A	10	
• Or miniature circuit breakers with C characteristic ($I_k < 400$ A)				

1) For endurance of the main contacts see page 3/19.

2) For conductor cross-sections see page 3/42.

3) For electromagnetic compatibility (EMC) see page 3/12.

4) Test conditions according to IEC 60947-4-1.

3RT, 3TB, 3TF Contactors for Switching Motors

3RT10 contactors, 3-pole, 3 ... 250 kW

Contactors	Type Size	3RT10 5. S6																																																	
Control																																																			
Operating range of the solenoid AC/DC (UC)		0.8 x $U_{s \min}$... 1.1 x $U_{s \max}$																																																	
Power consumption of the solenoid (when coil is cool and rated range $U_{s \min}$... $U_{s \max}$)																																																			
<ul style="list-style-type: none"> Conventional operating mechanism <ul style="list-style-type: none"> - AC operation <table border="0"> <tr> <td>Closing at $U_{s \min}$</td> <td>VA/p.f.</td> <td>250/0.9</td> </tr> <tr> <td>Closing at $U_{s \max}$</td> <td>VA/p.f.</td> <td>300/0.9</td> </tr> <tr> <td>Closed at $U_{s \min}$</td> <td>VA/p.f.</td> <td>4.8/0.8</td> </tr> <tr> <td>Closed at $U_{s \max}$</td> <td>VA/p.f.</td> <td>5.8/0.8</td> </tr> </table> - DC operation <table border="0"> <tr> <td>Closing at $U_{s \min}$</td> <td>W</td> <td>300</td> </tr> <tr> <td>Closing at $U_{s \max}$</td> <td>W</td> <td>360</td> </tr> <tr> <td>Closed at $U_{s \min}$</td> <td>W</td> <td>4.3</td> </tr> <tr> <td>Closed at $U_{s \max}$</td> <td>W</td> <td>5.2</td> </tr> </table> Solid-state operating mechanism <ul style="list-style-type: none"> - AC operation <table border="0"> <tr> <td>Closing at $U_{s \min}$</td> <td>VA/p.f.</td> <td>190/0.8</td> </tr> <tr> <td>Closing at $U_{s \max}$</td> <td>VA/p.f.</td> <td>280/0.8</td> </tr> <tr> <td>Closed at $U_{s \min}$</td> <td>VA/p.f.</td> <td>3.5/0.5</td> </tr> <tr> <td>Closed at $U_{s \max}$</td> <td>VA/p.f.</td> <td>4.4/0.4</td> </tr> </table> - DC operation <table border="0"> <tr> <td>Closing at $U_{s \min}$</td> <td>W</td> <td>250</td> </tr> <tr> <td>Closing at $U_{s \max}$</td> <td>W</td> <td>320</td> </tr> <tr> <td>Closed at $U_{s \min}$</td> <td>W</td> <td>2.3</td> </tr> <tr> <td>Closed at $U_{s \max}$</td> <td>W</td> <td>2.8</td> </tr> </table> 				Closing at $U_{s \min}$	VA/p.f.	250/0.9	Closing at $U_{s \max}$	VA/p.f.	300/0.9	Closed at $U_{s \min}$	VA/p.f.	4.8/0.8	Closed at $U_{s \max}$	VA/p.f.	5.8/0.8	Closing at $U_{s \min}$	W	300	Closing at $U_{s \max}$	W	360	Closed at $U_{s \min}$	W	4.3	Closed at $U_{s \max}$	W	5.2	Closing at $U_{s \min}$	VA/p.f.	190/0.8	Closing at $U_{s \max}$	VA/p.f.	280/0.8	Closed at $U_{s \min}$	VA/p.f.	3.5/0.5	Closed at $U_{s \max}$	VA/p.f.	4.4/0.4	Closing at $U_{s \min}$	W	250	Closing at $U_{s \max}$	W	320	Closed at $U_{s \min}$	W	2.3	Closed at $U_{s \max}$	W	2.8
Closing at $U_{s \min}$	VA/p.f.	250/0.9																																																	
Closing at $U_{s \max}$	VA/p.f.	300/0.9																																																	
Closed at $U_{s \min}$	VA/p.f.	4.8/0.8																																																	
Closed at $U_{s \max}$	VA/p.f.	5.8/0.8																																																	
Closing at $U_{s \min}$	W	300																																																	
Closing at $U_{s \max}$	W	360																																																	
Closed at $U_{s \min}$	W	4.3																																																	
Closed at $U_{s \max}$	W	5.2																																																	
Closing at $U_{s \min}$	VA/p.f.	190/0.8																																																	
Closing at $U_{s \max}$	VA/p.f.	280/0.8																																																	
Closed at $U_{s \min}$	VA/p.f.	3.5/0.5																																																	
Closed at $U_{s \max}$	VA/p.f.	4.4/0.4																																																	
Closing at $U_{s \min}$	W	250																																																	
Closing at $U_{s \max}$	W	320																																																	
Closed at $U_{s \min}$	W	2.3																																																	
Closed at $U_{s \max}$	W	2.8																																																	
PLC control input (EN 61131-2/type 2)		24 V DC/≤ 30 mA power consumption, (operating range 17 ... 30 V DC)																																																	
Operating times (Total break time = Opening delay + Arcing time)																																																			
<ul style="list-style-type: none"> Conventional operating mechanism <ul style="list-style-type: none"> - With 0.8 x $U_{s \min}$... 1.1 x $U_{s \max}$ <table border="0"> <tr> <td>Closing delay</td> <td>ms</td> <td>20 ... 95</td> </tr> <tr> <td>Opening delay</td> <td>ms</td> <td>40 ... 60</td> </tr> </table> - With $U_{s \min}$... $U_{s \max}$ <table border="0"> <tr> <td>Closing delay</td> <td>ms</td> <td>25 ... 50</td> </tr> <tr> <td>Opening delay</td> <td>ms</td> <td>40 ... 60</td> </tr> </table> Solid-state operating mechanism, actuated via PLC input <ul style="list-style-type: none"> - With 0.8 x $U_{s \min}$... 1.1 x $U_{s \max}$ <table border="0"> <tr> <td>Closing delay</td> <td>ms</td> <td>35 ... 75</td> </tr> <tr> <td>Opening delay</td> <td>ms</td> <td>80 ... 90</td> </tr> </table> - With $U_{s \min}$... $U_{s \max}$ <table border="0"> <tr> <td>Closing delay</td> <td>ms</td> <td>40 ... 60</td> </tr> <tr> <td>Opening delay</td> <td>ms</td> <td>80 ... 90</td> </tr> </table> Solid-state operating mechanism, actuated via A1/A2 <ul style="list-style-type: none"> - With 0.8 x $U_{s \min}$... 1.1 x $U_{s \max}$ <table border="0"> <tr> <td>Closing delay</td> <td>ms</td> <td>95 ... 135</td> </tr> <tr> <td>Opening delay</td> <td>ms</td> <td>80 ... 90</td> </tr> </table> - With $U_{s \min}$... $U_{s \max}$ <table border="0"> <tr> <td>Closing delay</td> <td>ms</td> <td>100 ... 120</td> </tr> <tr> <td>Opening delay</td> <td>ms</td> <td>80 ... 90</td> </tr> </table> Arcing time <table border="0"> <tr> <td></td> <td>ms</td> <td>10 ... 15</td> </tr> </table> 				Closing delay	ms	20 ... 95	Opening delay	ms	40 ... 60	Closing delay	ms	25 ... 50	Opening delay	ms	40 ... 60	Closing delay	ms	35 ... 75	Opening delay	ms	80 ... 90	Closing delay	ms	40 ... 60	Opening delay	ms	80 ... 90	Closing delay	ms	95 ... 135	Opening delay	ms	80 ... 90	Closing delay	ms	100 ... 120	Opening delay	ms	80 ... 90		ms	10 ... 15									
Closing delay	ms	20 ... 95																																																	
Opening delay	ms	40 ... 60																																																	
Closing delay	ms	25 ... 50																																																	
Opening delay	ms	40 ... 60																																																	
Closing delay	ms	35 ... 75																																																	
Opening delay	ms	80 ... 90																																																	
Closing delay	ms	40 ... 60																																																	
Opening delay	ms	80 ... 90																																																	
Closing delay	ms	95 ... 135																																																	
Opening delay	ms	80 ... 90																																																	
Closing delay	ms	100 ... 120																																																	
Opening delay	ms	80 ... 90																																																	
	ms	10 ... 15																																																	

3RT, 3TB, 3TF Contactors for Switching Motors

3RT10 contactors, 3-pole, 3 ... 250 kW

Contactors	Type Size		3RT10 54 S6	3RT10 55 S6	3RT10 56 S6
Main circuit					
AC capacity					
Utilization category AC-1					
Switching resistive loads					
• Rated operational currents I_e		At 40 °C up to 690 V	A 160	185	215
		At 60 °C up to 690 V	A 140	160	185
		At 60 °C up to 1000 V	A 80	90	100
• Rated power for AC loads ¹⁾ P.f. = 0.95 (at 60 °C)		At 230 V	kW 53	60	70
		400 V	kW 92	105	121
		500 V	kW 115	131	152
		690 V	kW 159	181	210
		1000 V	kW 131	148	165
• Minimum conductor cross-section for loads with I_e		At 40 °C	mm ² 70	95	95
		At 60 °C	mm ² 50	70	95
Utilization category AC-2 and AC-3					
• Rated operational currents I_e		Up to 500 V	A 115	150	185
		690 V	A 115	150	170
		1000 V	A 53	65	65
• Rated power of slipping or squirrel-cage motors at 50 and 60 Hz		At 230 V	kW 37	50	61
		400 V	kW 64	84	104
		500 V	kW 81	105	132
		690 V	kW 113	146	167
		1000 V	kW 75	90	90
Thermal load capacity		10 s current ²⁾	A 1100	1300	1480
Power loss per main current path		At $I_e/AC-3/500$ V	W 7	9	13
Utilization category AC-4 (for $I_a = 6 \times I_e$)					
• Rated operational current I_e		Up to 400 V	A 97	132	160
• Rated power for squirrel-cage motors with 50 Hz and 60 Hz		At 400 V	kW 55	75	90
• The following applies to a contact endurance of about 200 000 operating cycles:					
- Rated operational currents I_e		Up to 500 V	A 54	68	81
		690 V	A 48	57	65
		1000 V	A 34	38	42
- Rated power for squirrel-cage motors with 50 Hz and 60 Hz		At 230 V	kW 16	20	25
		400 V	kW 29	38	45
		500 V	kW 37	47	57
		690 V	kW 48	55	65
		1000 V	kW 49	55	60
Utilization category AC-6a switching AC transformers					
• Rated operational current I_e					
- For inrush current n = 20		Up to 690 V	A 115	148	148
- For inrush current n = 30		Up to 690 V	A 90	99	99
• Rating P					
- For inrush current n = 20		At 230 V	kVA 45	58	58
		400 V	kVA 79	102	102
		500 V	kVA 99	128	128
		690 V	kVA 137	176	176
		1000 V	kVA 80	98	117
- For inrush current n = 30		At 230 V	kVA 35	39	39
		400 V	kVA 62	68	68
		500 V	kVA 77	85	85
		690 V	kVA 107	118	118
		1000 V	kVA 80	98	117
For deviating inrush current factors x, the power must be recalculated as follows: $P_x = P_{n,30} \cdot 30/x$					
Utilization category AC-6b switching low-inductance (low-loss, metallized dielectric) AC capacitors					
Ambient temperature 40 °C					
• Rated operational currents I_e		Up to 500 V	A 105	125	145
• Rated power for single capacitors or banks of capacitors (minimum inductance of 6 µH between capacitors connected in parallel) at 50 Hz, 60 Hz		At 230 V	kvar 42	50	58
		400 V	kvar 72	86	100
		500 V	kvar 90	108	125
		690 V	kvar 72	86	100

¹⁾ Industrial furnaces and electric heaters with resistance heating, etc. (increased power consumption on heating up has been taken into account).

²⁾ According to IEC 60947-4-1.
For rated values for various start-up conditions see "Protection Equipment --> Overload Relays".







3RT, 3TB, 3TF Contactors for Switching Motors

3RT10 contactors, 3-pole, 3 ... 250 kW

Contactors	Type Size	3RT10 54 S6	3RT10 55 S6	3RT10 56 S6
Main circuit				
<i>Load rating with DC</i>				
Utilization category DC-1				
Switching resistive load ($L/R \leq 1$ ms)				
• Rated operational current I_e (at 60 °C)				
- 1 conducting path		Up to 24 V A	160	
		60 V A	160	
		110 V A	18	
		220 V A	3.4	
		440 V A	0.8	
		600 V A	0.5	
- 2 conducting paths in series		Up to 24 V A	160	
		60 V A	160	
		110 V A	160	
		220 V A	20	
		440 V A	3.2	
		600 V A	1.6	
- 3 conducting paths in series		Up to 24 V A	160	
		60 V A	160	
		110 V A	160	
		220 V A	160	
		440 V A	11.5	
		600 V A	4	
Utilization category DC-3 and DC-5				
Shunt-wound and series-wound motors ($L/R \leq 15$ ms)				
• Rated operational current I_e (at 60 °C)				
- 1 conducting path		Up to 24 V A	160	
		60 V A	7.5	
		110 V A	2.5	
		220 V A	0.6	
		440 V A	0.17	
		600 V A	0.12	
- 2 conducting paths in series		Up to 24 V A	160	
		60 V A	160	
		110 V A	160	
		220 V A	2.5	
		440 V A	0.65	
		600 V A	0.37	
- 3 conducting paths in series		Up to 24 V A	160	
		60 V A	160	
		110 V A	160	
		220 V A	160	
		440 V A	1.4	
		600 V A	0.75	
<i>Switching frequency</i>				
Switching frequency z in operating cycles/hour				
• Contactors without overload relays	No-load switching frequency	h ⁻¹	2000	2000
Dependence of the switching frequency z' on the operational current I' and operational voltage U':				
	AC-1	h ⁻¹	800	800
	AC-2	h ⁻¹	400	300
	AC-3	h ⁻¹	1000	750
	AC-4	h ⁻¹	130	130
• Contactors with overload relays (mean value)		h ⁻¹	60	60

3RT, 3TB, 3TF Contactors for Switching Motors

3RT10 contactors, 3-pole, 3 ... 250 kW

Contactor	Type Size	3RT10 5. S6	
Conductor cross-sections of main conductors with box terminal			
(1 or 2 conductors can be connected)	Main conductors: With 3RT19 55-4G box terminal (55 kW)		 Screw terminals
Front or rear clamping point connected	<ul style="list-style-type: none"> Finely stranded with end sleeve Finely stranded without end sleeve Stranded Ribbon cable conductors (number x width x thickness) AWG cables, solid or stranded 	mm ² mm ² mm ² mm AWG	16 ... 70 16 ... 70 16 ... 70 Min. 3 x 9 x 0.8, max. 6 x 15.5 x 0.8 6 ... 2/0
			
Both clamping points connected	<ul style="list-style-type: none"> Finely stranded with end sleeve Finely stranded without end sleeve Stranded Ribbon cable conductors (number x width x thickness) AWG cables, solid or stranded Terminal screw - Tightening torque 	mm ² mm ² mm ² mm AWG Nm	Max. 1 x 50, 1 x 70 Max. 1 x 50, 1 x 70 max. 2 x 70 Max. 2 x (6 x 15.5 x 0.8) Max. 2 x 1/0 M10 (hexagon socket, A/F 4) 10 ... 12 (90 ... 110 lb.in)
			
(1 or 2 conductors can be connected)	Main conductors: With 3RT19 56-4G box terminal		
Front or rear clamping point connected	<ul style="list-style-type: none"> Finely stranded with end sleeve Finely stranded without end sleeve Stranded Ribbon cable conductors (number x width x thickness) AWG cables, solid or stranded 	mm ² mm ² mm ² mm AWG	16 ... 120 16 ... 120 16 ... 120 Min. 3 x 9 x 0.8, max. 10 x 15.5 x 0.8 6 ... 250 kcmil
			
Both clamping points connected	<ul style="list-style-type: none"> Finely stranded with end sleeve Finely stranded without end sleeve Stranded Ribbon cable conductors (number x width x thickness) AWG cables, solid or stranded Terminal screw - Tightening torque 	mm ² mm ² mm ² mm AWG Nm	Max. 1 x 95, 1 x 120 Max. 1 x 95, 1 x 120 Max. 2 x 120 Max. 2 x (10 x 15.5 x 0.8) Max. 2 x 3/0 M10 (hexagon socket, A/F 4) 10 ... 12 (90 ... 110 lb.in)
			
	Main conductors: Without box terminal/busbar connection		
	<ul style="list-style-type: none"> Finely stranded with cable lug¹⁾ Stranded with cable lug¹⁾ AWG cables, solid or stranded Connecting bar (max. width) Terminal screw - Tightening torque 	mm ² mm ² AWG mm Nm	16 ... 95 25 ... 120 4 ... 250 kcmil 17 M8 x 25 (A/F 13) 10 ... 14 (89 ... 124 lb.in)
	Auxiliary conductors:		
	<ul style="list-style-type: none"> Solid Finely stranded with end sleeve AWG cables, solid or stranded Terminal screw - Tightening torque 	mm ² mm ² AWG Nm	2 x (0.5 ... 1.5) ²⁾ ; 2 x (0.75 ... 2.5) ²⁾ acc. to IEC 60947; max. 2 x (0.75 ... 4) 2 x (0.5 ... 1.5) ²⁾ ; 2 x (0.75 ... 2.5) ²⁾ 2 x (18 ... 14) M3 (PZ 2) 0.8 ... 1.2 (7 ... 10.3 lb.in)
	Auxiliary conductors:		 Cage Clamp terminals
	<ul style="list-style-type: none"> Solid Finely stranded with end sleeve Finely stranded without end sleeve AWG cables, solid or stranded 	mm ² mm ² mm ² AWG	2 x (0.25 ... 2.5) 2 x (0.25 ... 1.5) 2 x (0.25 ... 2.5) 2 x (24 ... 14)

For tools for opening Cage Clamp terminals see Catalog LV 1, Chapter 3, Accessories and Spare Parts.
Maximum external diameter of the conductor insulation: 3.6 mm.
For conductor cross-sections $\leq 1 \text{ mm}^2$ an "insulation stop" must be used, see Catalog LV 1, Chapter 3, "Accessories and Spare Parts".

- 1) When connecting cable lugs to DIN 46235, use 3RT19 56-4EA1 terminal cover for conductor cross-sections from 95 mm² to ensure phase spacing.
2) If two different conductor cross-sections are connected to one clamping point, both cross-sections must lie in the range specified. If identical cross-sections are used, this restriction does not apply.

3RT, 3TB, 3TF Contactors for Switching Motors

3RT10 contactors, 3-pole, 3 ... 250 kW

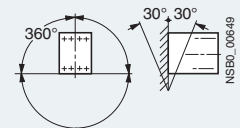
Contactors	Type Size	3RT10 64 S10	3RT10 65 S10	3RT10 66 S10
General data				
Permissible mounting position The contactors are designed for operation on a vertical mounting surface.				
Mechanical endurance	Oper- ating cycles	10 million		
Electrical endurance		1)		
Rated insulation voltage U_i (degree of pollution 3)	V	1000		
Rated impulse withstand voltage U_{imp}	kV	8		
Protective separation between the coil and the main contacts acc. to EN 60947-1, Appendix N	V	690		
Mirror contacts A mirror contact is an auxiliary NC contact that cannot be closed simultaneously with a NO main contact.		Yes, acc. to EN 60947-4-1, Appendix F		
Permissible ambient temperature	<ul style="list-style-type: none"> • During operation • During storage 	°C	-25 ... +60/+55 with AS-Interface	
Degree of protection acc. to EN 60947-1, Appendix C		°C	-55 ... +80	
Touch protection acc. to EN 50274			IP00/open, coil assembly IP20 Finger-safe with cover	
Shock resistance	<ul style="list-style-type: none"> • Rectangular pulse • Sine pulse 	g/ms g/ms	8.5/5 and 4.2/10 13.4/5 and 6.5/10	
Conductor cross-sections			2)	
Electromagnetic compatibility (EMC)			3)	
Short-circuit protection				
Main circuit				
Fuse links, gL/gG				
LV HRC 3NA, DIAZED 5SB, NEOZED 5SE				
acc. to IEC 60947-4-1/ EN 60947-4-1				
	<ul style="list-style-type: none"> • Type of coordination "1" • Type of coordination "2" • Weld-free⁴⁾ 	A	500	
		A	400	
		A	250	
Auxiliary circuit				
	<ul style="list-style-type: none"> • Fuse links gL/gG DIAZED 5SB, NEOZED 5SE (weld-free protection at $I_k \geq 1$ kA) • Or miniature circuit breakers with C characteristic (short-circuit current $I_k < 400$ A) 	A	10	

¹⁾ For endurance of the main contacts see page 3/19.

²⁾ For conductor cross-sections see page 3/47.

³⁾ For electromagnetic compatibility (EMC) see page 3/12.

⁴⁾ Test conditions according to IEC 60947-4-1.

3RT, 3TB, 3TF Contactors for Switching Motors

3RT10 contactors, 3-pole, 3 ... 250 kW

Contactor	Type Size		3RT10 64 S10	3RT10 65 S10	3RT10 66 S10
Control					
Operating range of the solenoid AC/DC (UC)			$0.8 \times U_{s \min} \dots 1.1 \times U_{s \max}$		
Power consumption of the solenoid (when coil is cool and rated range $U_{s \min} \dots U_{s \max}$)					
• Conventional operating mechanism					
- AC operation	Closing at $U_{s \min}$	VA/p.f.	490/0.9		
	Closing at $U_{s \max}$	VA/p.f.	590/0.9		
	Closed at $U_{s \min}$	VA/p.f.	5.6/0.9		
	Closed at $U_{s \max}$	VA/p.f.	6.7/0.9		
- DC operation	Closing at $U_{s \min}$	W	540		
	Closing at $U_{s \max}$	W	650		
	Closed at $U_{s \min}$	W	6.1		
	Closed at $U_{s \max}$	W	7.4		
• Solid-state operating mechanism					
- AC operation	Closing at $U_{s \min}$	VA/p.f.	400/0.8		
	Closing at $U_{s \max}$	VA/p.f.	530/0.8		
	Closed at $U_{s \min}$	VA/p.f.	4/0.5		
	Closed at $U_{s \max}$	VA/p.f.	5/0.4		
- DC operation	Closing at $U_{s \min}$	W	440		
	Closing at $U_{s \max}$	W	580		
	Closed at $U_{s \min}$	W	3.2		
	Closed at $U_{s \max}$	W	3.8		
PLC control input (EN 61131-2/type 2)			24 V DC/≤ 30 mA power consumption, (operating range 17 ... 30 V DC)		
Operating times (Total break time = Opening delay + Arcing time)					
• Conventional operating mechanism					
- With $0.8 \times U_{s \min} \dots 1.1 \times U_{s \max}$	Closing delay	ms	30 ... 95		
	Opening delay	ms	40 ... 80		
- For $U_{s \min} \dots U_{s \max}$	Closing delay	ms	35 ... 50		
	Opening delay	ms	50 ... 80		
• Solid-state operating mechanism, actuated via A1/A2					
- With $0.8 \times U_{s \min} \dots 1.1 \times U_{s \max}$	Closing delay	ms	105 ... 145		
	Opening delay	ms	80 ... 100		
- For $U_{s \min} \dots U_{s \max}$	Closing delay	ms	110 ... 130		
	Opening delay	ms	80 ... 100		
• Solid-state operating mechanism, actuated via PLC input					
- With $0.8 \times U_{s \min} \dots 1.1 \times U_{s \max}$	Closing delay	ms	45 ... 80		
	Opening delay	ms	80 ... 100		
- For $U_{s \min} \dots U_{s \max}$	Closing delay	ms	50 ... 65		
	Opening delay	ms	80 ... 100		
• Arcing time					
		ms	10 ... 15		

3RT, 3TB, 3TF Contactors for Switching Motors

3RT10 contactors, 3-pole, 3 ... 250 kW

Contactors	Type Size		3RT10 64 S10	3RT10 65 S10	3RT10 66 S10
Main circuit					
AC capacity					
Utilization category AC-1					
Switching resistive loads					
• Rated operational currents I_e	At 40 °C up to 690 V	A	275	330	
	At 60 °C up to 690 V	A	250	300	
	At 60 °C up to 1000 V	A	100	150	
• Rated power for AC loads ¹⁾ P.f. = 0.95 (at 60 °C)	At 230 V	kW	94	113	
	400 V	kW	164	197	
	500 V	kW	205	246	
	690 V	kW	283	340	
	1000 V	kW	164	246	
• Minimum conductor cross-section for loads with I_e	At 40 °C	mm ²	150	185	
	At 60 °C	mm ²	120	185	
Utilization category AC-2 and AC-3					
• Rated operational currents I_e	Up to 500 V	A	225	265	300
	690 V	A	225	265	280
	1000 V	A	68	95	95
• Rated power of slipping or squirrel-cage motors at 50 and 60 Hz	At 230 V	kW	73	85	97
	400 V	kW	128	151	171
	500 V	kW	160	189	215
	690 V	kW	223	265	280
	1000 V	kW	90	132	132
Thermal load capacity	10 s current ²⁾	A	1800	2400	2400
Power loss per main current path	At I_e /AC-3/500 V	W	17	18	22
Utilization category AC-4 (for $I_a = 6 \times I_e$)					
• Rated operational current I_e	Up to 400 V	A	195	230	280
• Rated power for squirrel-cage motors with 50 Hz and 60 Hz	At 400 V	kW	110	132	160
• The following applies to a contact endurance of about 200 000 operating cycles:					
- Rated operational currents I_e	Up to 500 V	A	96	117	125
	690 V	A	85	105	115
	1000 V	A	42	57	57
- Rated power for squirrel-cage motors with 50 Hz and 60 Hz	At 230 V	kW	30	37	40
	400 V	kW	54	66	71
	500 V	kW	67	82	87
	690 V	kW	82	102	112
	1000 V	kW	59	80	80
Utilization category AC-6a switching AC transformers					
• Rated operational current I_e					
- For inrush current n = 20	Up to 690 V	A	227	265	273
- For inrush current n = 30	Up to 690 V	A	151	182	182
• Rated power P					
- For inrush current n = 20	At 230 V	kVA	90	105	109
	400 V	kVA	157	183	189
	500 V	kVA	196	229	236
	690 V	kVA	271	317	326
	1000 V	kVA	117	164	164
- For inrush current n = 30	At 230 V	kVA	60	72	72
	400 V	kVA	105	126	126
	500 V	kVA	130	158	158
	690 V	kVA	180	217	217
	1000 V	kVA	117	164	164
For deviating inrush current factors x, the power must be recalculated as follows: $P_x = P_{n30} \cdot 30/x$					
Utilization category AC-6b Switching low-inductance (low-loss, metallized dielectric) AC capacitors					
Ambient temperature 40 °C					
• Rated operational currents I_e	Up to 500 V	A	183	220	
• Rated power for single capacitors or banks of capacitors (minimum inductance of 6 µH between capacitors connected in parallel) at 50 Hz, 60 Hz and	At 230 V	kvar	73	88	
	400 V	kvar	127	152	
	500 V	kvar	159	191	
	690 V	kvar	127	152	

¹⁾ Industrial furnaces and electric heaters with resistance heating, etc. (increased power consumption on heating up has been taken into account).

²⁾ According to IEC 60947-4-1.
For rated values for various start-up conditions see "Protection Equipment --> Overload Relays".





3RT, 3TB, 3TF Contactors for Switching Motors

3RT10 contactors, 3-pole, 3 ... 250 kW

Contactor	Type Size		3RT10 64 S10	3RT10 65 S10	3RT10 66 S10
Main circuit					
<i>Load rating with DC</i>					
Utilization category DC-1					
Switching resistive load ($L/R \leq 1$ ms)					
• Rated operational current I_e (at 60 °C)					
- 1 conducting path		Up to 24 V A	200	300	
		60 V A	200	300	
		110 V A	18	33	
		220 V A	3.4	3.8	
		440 V A	0.8	0.9	
		600 V A	0.5	0.6	
- 2 conducting paths in series		Up to 24 V A	200	300	
		60 V A	200	300	
		110 V A	200	300	
		220 V A	20	300	
		440 V A	3.2	4	
		600 V A	1.6	2	
- 3 conducting paths in series		Up to 24 V A	200	300	
		60 V A	200	300	
		110 V A	200	300	
		220 V A	200	300	
		440 V A	11.5	11	
		600 V A	4	5.2	
Utilization category DC-3 and DC-5					
Shunt-wound and series-wound motors ($L/R \leq 15$ ms)					
• Rated operational current I_e (at 60 °C)					
- 1 conducting path		Up to 24 V A	200	300	
		60 V A	7.5	11	
		110 V A	2.5	3	
		220 V A	0.6	0.6	
		440 V A	0.17	0.18	
		600 V A	0.12	0.125	
- 2 conducting paths in series		Up to 24 V A	200	300	
		60 V A	200	300	
		110 V A	200	300	
		220 V A	2.5	2.5	
		440 V A	0.65	0.65	
		600 V A	0.37	0.37	
- 3 conducting paths in series		Up to 24 V A	200	300	
		60 V A	200	300	
		110 V A	200	300	
		220 V A	200	300	
		440 V A	1.4	1.4	
		600 V A	0.75	0.75	
Switching frequency					
Switching frequency z in operating cycles/hour					
• Contactors without overload relays	No-load switching frequency	h ⁻¹	2000	2000	2000
Dependence of the switching frequency z' on the operational current I' and operational voltage U':	AC-1	h ⁻¹	750	800	750
$z' = z \cdot (I_e/I') \cdot (400 V/U')^{1.5} \cdot 1/h$	AC-2	h ⁻¹	250	300	250
	AC-3	h ⁻¹	500	700	500
	AC-4	h ⁻¹	130	130	130
• Contactors with overload relays (mean value)		h ⁻¹	60	60	60

3RT, 3TB, 3TF Contactors for Switching Motors

3RT10 contactors, 3-pole, 3 ... 250 kW

Contactors	Type Size	3RT10 6. S10		
Conductor cross-sections				
Front clamping point connected 	Main conductors: With 3RT19 66-4G box terminal		 Screw terminals	
	<ul style="list-style-type: none"> Finely stranded with end sleeve Finely stranded without end sleeve Stranded AWG cables, solid or stranded Ribbon cable conductors (number x width x thickness) 	mm ² mm ² mm ² AWG mm		70 ... 240 70 ... 240 95 ... 300 3/0 ... 600 kcmil Min. 6 x 9 x 0.8, max. 20 x 24 x 0.5
	Rear clamping point connected 	<ul style="list-style-type: none"> Finely stranded with end sleeve Finely stranded without end sleeve Stranded AWG cables, solid or stranded Ribbon cable conductors (number x width x thickness) 		mm ² mm ² mm ² AWG mm
Both clamping points connected 	<ul style="list-style-type: none"> Finely stranded with end sleeve Finely stranded without end sleeve Stranded AWG cables, solid or stranded Ribbon cable conductors (number x width x thickness) Terminal screws - Tightening torque 	mm ² mm ² mm ² AWG mm Nm	Min. 2 x 50, max. 2 x 185 Min. 2 x 50, max. 2 x 185 Min. 2 x 70, max. 2 x 240 Min. 2 x 2/0, max. 2 x 500 kcmil Max. 2 x (20 x 24 x 0.5) M12 (hexagon socket, A/F 5) 20 ... 22 (180 ... 195 lb.in)	
		Main conductors: Without box terminal/ busbar connection		
		<ul style="list-style-type: none"> Finely stranded with cable lug¹⁾ Stranded with cable lug¹⁾ AWG cables, solid or stranded Connecting bar (max. width) Terminal screws - Tightening torque 	mm ² mm ² AWG mm Nm	50 ... 240 70 ... 240 2/0 ... 500 kcmil 25 M10 x 30 (A/F 17) 14 ... 24 (124 ... 210 lb.in)
		Auxiliary conductors: <ul style="list-style-type: none"> Solid Finely stranded with end sleeve AWG cables, solid or stranded Terminal screws - Tightening torque 	mm ² mm ² AWG Nm	2 x (0.5 ... 1.5) ²⁾ ; 2 x (0.75 ... 2.5) ²⁾ acc. to IEC 60947; max. 2 x (0.75 ... 4) 2 x (0.5 ... 1.5) ²⁾ ; 2 x (0.75 ... 2.5) ²⁾ 2 x (18 ... 14) M3 (PZ 2) 0.8 ... 1.2 (7 ... 10.3 lb.in)
		Auxiliary conductors: <ul style="list-style-type: none"> Solid Finely stranded with end sleeve Finely stranded without end sleeve AWG cables, solid or stranded 	mm ² mm ² mm ² AWG	 Cage Clamp terminals 2 x (0.25 ... 2.5) 2 x (0.25 ... 1.5) 2 x (0.25 ... 2.5) 2 x (24 ... 14)

For tools for opening Cage Clamp terminals see Catalog LV 1, Chapter 3, Accessories and Spare Parts.

Maximum external diameter of the conductor insulation: 3.6 mm. For conductor cross-sections $\leq 1 \text{ mm}^2$ an "insulation stop" must be used, see Catalog LV 1, Chapter 3, "Accessories and Spare Parts".

¹⁾ When connecting cable lugs to DIN 46234, the 3RT19 66-4EA1 terminal cover must be used for conductor cross-sections of 240 mm² and more as well as DIN 46235 for conductor cross-sections of 185 mm² and more to keep the phase clearance.

²⁾ If two different conductor cross-sections are connected to one clamping point, both cross-sections must lie in the range specified. If identical cross-sections are used, this restriction does not apply.

3RT, 3TB, 3TF Contactors for Switching Motors

3RT10 contactors, 3-pole, 3 ... 250 kW

Contactor	Type Size	3RT10 75 S12		3RT10 76 S12	
General data					
Permissible mounting position The contactors are designed for operation on a vertical mounting surface.					
Mechanical endurance	Operating cycles	10 million			
Electrical endurance		1)			
Rated insulation voltage U_i (degree of pollution 3)	V	1000			
Rated impulse withstand voltage U_{imp}	kV	8			
Protective separation between the coil and the main contacts acc. to EN 60947-1, Appendix N	V	690			
Mirror contacts A mirror contact is an auxiliary NC contact that cannot be closed simultaneously with a NO main contact.		Yes, acc. to EN 60947-4-1, Appendix F			
Permissible ambient temperature	<ul style="list-style-type: none"> During operation During storage 	°C	-25 ... +60/+55 with AS-Interface		
		°C	-55 ... +80		
Degree of protection acc. to EN 60947-1, Appendix C		IP00/open, coil assembly IP20			
Touch protection acc. to EN 50274		Finger-safe with cover			
Shock resistance	<ul style="list-style-type: none"> Rectangular pulse Sine pulse 	g/ms	8.5/5 and 4.2/10		
		g/ms	13.4/5 and 6.5/10		
Conductor cross-sections		2)			
Electromagnetic compatibility (EMC)		3)			
Short-circuit protection					
Main circuit					
Fuse links, gL/gG					
LV HRC 3NA, DIAZED 5SB, NEOZED 5SE					
acc. to IEC 60947-4-1/ EN 60947-4-1					
	<ul style="list-style-type: none"> Type of coordination "1" Type of coordination "2" Weld-free⁴⁾ 	A	630	630	
		A	500	500	
		A	250	315	
Auxiliary circuit					
<ul style="list-style-type: none"> Fuse links gL/gG DIAZED 5SB, NEOZED 5SE (weld-free protection for $I_k \geq 1$ kA) Or miniature circuit breakers with C characteristic (short-circuit current $I_k < 400$ A) 		A	10		

1) For endurance of the main contacts see page 3/19.

2) For conductor cross-sections see page 3/52.

3) For electromagnetic compatibility (EMC) see page 3/12.

4) Test conditions according to IEC 60947-4-1.

3RT, 3TB, 3TF Contactors for Switching Motors

3RT10 contactors, 3-pole, 3 ... 250 kW

Contactors	Type Size		3RT10 75 S12	3RT10 76 S12
Control				
Operating range of the solenoid AC/DC (UC)			0.8 x $U_{s \min}$... 1.1 x $U_{s \max}$	
Power consumption of the solenoid (when coil is cool and rated range $U_{s \min}$... $U_{s \max}$)				
• Conventional operating mechanism				
- AC operation	Closing at $U_{s \min}$	VA/p.f.	700/0.9	
	Closing at $U_{s \max}$	VA/p.f.	830/0.9	
	Closed at $U_{s \min}$	VA/p.f.	7.6/0.9	
	Closed at $U_{s \max}$	VA/p.f.	9.2/0.9	
- DC operation	Closing at $U_{s \min}$	W	770	
	Closing at $U_{s \max}$	W	920	
	Closed at $U_{s \min}$	W	8.5	
	Closed at $U_{s \max}$	W	10	
• Solid-state operating mechanism				
- AC operation	Closing at $U_{s \min}$	VA/p.f.	560/0.8	
	Closing at $U_{s \max}$	VA/p.f.	750/0.8	
	Closed at $U_{s \min}$	VA/p.f.	5.4/0.8	
	Closed at $U_{s \max}$	VA/p.f.	7/0.8	
- DC operation	Closing at $U_{s \min}$	W	600	
	Closing at $U_{s \max}$	W	800	
	Closed at $U_{s \min}$	W	4	
	Closed at $U_{s \max}$	W	5	
PLC control input (EN 61131-2/type 2)			24 V DC/≤ 30 mA power consumption, (operating range 17 ... 30 V DC)	
Operating times (Total break time = Opening delay + Arcing time)				
• Conventional operating mechanism				
- With 0.8 x $U_{s \min}$... 1.1 x $U_{s \max}$	Closing delay	ms	45 ... 100	
	Opening delay	ms	60 ... 100	
- For $U_{s \min}$... $U_{s \max}$	Closing delay	ms	50 ... 70	
	Opening delay	ms	70 ... 100	
• Solid-state operating mechanism, actuated via A1/A2				
- With 0.8 x $U_{s \min}$... 1.1 x $U_{s \max}$	Closing delay	ms	120 ... 150	
	Opening delay	ms	80 ... 100	
- For $U_{s \min}$... $U_{s \max}$	Closing delay	ms	125 ... 150	
	Opening delay	ms	80 ... 100	
• Solid-state operating mechanism, actuated via PLC input				
- With 0.8 x $U_{s \min}$... 1.1 x $U_{s \max}$	Closing delay	ms	60 ... 90	
	Opening delay	ms	80 ... 100	
- For $U_{s \min}$... $U_{s \max}$	Closing delay	ms	65 ... 80	
	Opening delay	ms	80 ... 100	
• Arcing time				
		ms	10 ... 15	

3RT, 3TB, 3TF Contactors for Switching Motors

3RT10 contactors, 3-pole, 3 ... 250 kW

Contactors	Type Size		3RT10 75 S12	3RT10 76 S12
Main circuit				
<i>AC capacity</i>				
Utilization category AC-1				
Switching resistive loads				
• Rated operational currents I_e		At 40 °C up to 690 V	A 430	610
		At 60 °C up to 690 V	A 400	550
		At 60 °C up to 1000 V	A 200	200
• Rated power for AC loads ¹⁾ P.f. = 0.95 (at 60 °C)		At 230 V	kW 151	208
		400 V	kW 263	362
		500 V	kW 329	452
		690 V	kW 454	624
		1000 V	kW 329	329
• Minimum conductor cross-section for loads with I_e		At 40 °C	mm ² 2 x 150	2 x 185
		At 60 °C	mm ² 240	2 x 185
Utilization category AC-2 and AC-3				
• Rated operational currents I_e		Up to 500 V	A 400	500
		690 V	A 400	450
		1000 V	A 180	180
• Rated power of slipping or squirrel-cage motors at 50 and 60 Hz		At 230 V	kW 132	164
		400 V	kW 231	291
		500 V	kW 291	363
		690 V	kW 400	453
		1000 V	kW 250	250
Thermal load capacity		10 s current ²⁾	A 3200	4000
Power loss per main current path		At $I_e/AC-3/500$ V	W 35	55
Utilization category AC-4 (for $I_a = 6 \times I_e$)				
• Rated operational current I_e		Up to 400 V	A 350	430
• Rated power for squirrel-cage motors with 50 Hz and 60 Hz		At 400 V	kW 200	250
• The following applies to a contact endurance of about 200 000 operating cycles:				
- Rated operational current I_e		Up to 500 V	A 150	175
		690 V	A 135	150
		1000 V	A 80	80
- Rated power for squirrel-cage motors with 50 Hz and 60 Hz		At 230 V	kW 48	56
		400 V	kW 85	98
		500 V	kW 105	123
		690 V	kW 133	148
		1000 V	kW 113	113
Utilization category AC-6a switching AC transformers				
• Rated operational current I_e				
- For inrush current n = 20		Up to 690 V	A 377	404
- For inrush current n = 30		Up to 690 V	A 251	270
• Rating P				
- For inrush current n = 20		At 230 V	kVA 150	161
		400 V	kVA 261	280
		500 V	kVA 326	350
		690 V	kVA 450	483
		1000 V	kVA 311	311
- For inrush current n = 30		At 230 V	kVA 100	107
		400 V	kVA 173	187
		500 V	kVA 217	234
		690 V	kVA 300	323
		1000 V	kVA 311	311
For deviating inrush current factors x, the power must be recalculated as follows: $P_x = P_{n30} \cdot 30/x$				
Utilization category AC-6b switching low-inductance (low-loss, metallized dielectric) AC capacitors				
Ambient temperature 40 °C				
• Rated operational currents I_e		Up to 500 V	A 287	407
• Rated power for single capacitors or banks of capacitors (minimum inductance of 6 µH between capacitors connected in parallel) at 50 Hz, 60 Hz and		At 230 V	kvar 114	162
		400 V	kvar 199	282
		500 V	kvar 248	352
		690 V	kvar 199	282

1) Industrial furnaces and electric heaters with resistance heating, etc. (increased power consumption on heating up taken into account).

2) According to IEC 60947-4-1.
For rated values for various start-up conditions see "Protection Equipment --> Overload Relays".





3RT, 3TB, 3TF Contactors for Switching Motors

3RT10 contactors, 3-pole, 3 ... 250 kW

Contactors	Type Size	3RT10 75 S12	3RT10 76 S12
Main circuit			
<i>Load rating with DC</i>			
Utilization category DC-1			
Switching resistive load ($L/R \leq 1$ ms)			
• Rated operational current I_e (at 60 °C)			
- 1 conducting path		Up to 24 V A 400 60 V A 330 110 V A 33 220 V A 3.8 440 V A 0.9 600 V A 0.6	
- 2 conducting paths in series		Up to 24 V A 400 60 V A 400 110 V A 400 220 V A 400 440 V A 4 600 V A 2	
- 3 conducting paths in series		Up to 24 V A 400 60 V A 400 110 V A 400 220 V A 400 440 V A 11 600 V A 5.2	
Utilization category DC-3 and DC-5			
Shunt-wound and series-wound motors ($L/R \leq 15$ ms)			
• Rated operational current I_e (at 60 °C)			
- 1 conducting path		Up to 24 V A 400 60 V A 11 110 V A 3 220 V A 0.6 440 V A 0.18 600 V A 0.125	
- 2 conducting paths in series		Up to 24 V A 400 60 V A 400 110 V A 400 220 V A 2.5 440 V A 0.65 600 V A 0.37	
- 3 conducting paths in series		Up to 24 V A 400 60 V A 400 110 V A 400 220 V A 400 440 V A 1.4 600 V A 0.75	
Switching frequency			
Switching frequency z in operating cycles/hour			
• Contactors without overload relays	No-load switching frequency	h^{-1} 2000	2000
Dependence of the switching frequency z' on the operational current I' and operational voltage U' :		AC-1 h^{-1} 700	500
$z' = z \cdot (I_e/I') \cdot (400 V/U')^{1.5} \cdot 1/h$		AC-2 h^{-1} 200	170
		AC-3 h^{-1} 500	420
		AC-4 h^{-1} 130	130
• Contactors with overload relays (mean value)		h^{-1} 60	60

3RT, 3TB, 3TF Contactors for Switching Motors

3RT10 contactors, 3-pole, 3 ... 250 kW

Contactors	Type Size	3RT10 7. S12	
Conductor cross-sections			
Front clamping point connected 	Main conductors: <u>With 3RT19 66-4G box terminal</u>		 Screw terminals
	<ul style="list-style-type: none"> • Finely stranded with end sleeve • Finely stranded without end sleeve • Stranded • AWG cables, solid or stranded • Ribbon cable conductors (number x width x thickness) 	<ul style="list-style-type: none"> mm² 70 ... 240 mm² 70 ... 240 mm² 95 ... 300 AWG 3/0 ... 600 kcmil mm² Min. 6 x 9 x 0.8, max. 20 x 24 x 0.5 	
Rear clamping point connected 	<ul style="list-style-type: none"> • Finely stranded with end sleeve • Finely stranded without end sleeve • Stranded • AWG cables, solid or stranded • Ribbon cable conductors (number x width x thickness) 		<ul style="list-style-type: none"> mm² 120 ... 185 mm² 120 ... 185 mm² 120 ... 240 AWG 250 ... 500 kcmil mm² Min. 6 x 9 x 0.8, max. 20 x 24 x 0.5
	Both clamping points connected 	<ul style="list-style-type: none"> • Finely stranded with end sleeve • Finely stranded without end sleeve • Stranded • AWG cables, solid or stranded • Ribbon cable conductors (number x width x thickness) • Terminal screws - Tightening torque 	
Main conductors: <u>Without box terminal/ busbar connection</u>		<ul style="list-style-type: none"> • Finely stranded with cable lug¹⁾ • Stranded with cable lug¹⁾ • AWG cables, solid or stranded • Connecting bar (max. width) • Terminal screws - Tightening torque 	<ul style="list-style-type: none"> mm² 50 ... 240 mm² 70 ... 240 AWG 2/0 ... 500 kcmil mm 25 M10 x 30 (A/F 17) Nm 14 ... 24 (124 ... 210 lb.in)
Auxiliary conductors:		<ul style="list-style-type: none"> • Solid • Finely stranded with end sleeve • AWG cables, solid or stranded • Terminal screws - Tightening torque 	<ul style="list-style-type: none"> mm² 2 x (0.5 ... 1.5)²⁾; 2 x (0.75 ... 2.5)²⁾ acc. to IEC 60947; max. 2 x (0.75 ... 4) mm² 2 x (0.5 ... 1.5)²⁾; 2 x (0.75 ... 2.5)²⁾ AWG 2 x (18 ... 14) M3 (PZ 2) Nm 0.8 ... 1.2 (7 ... 10.3 lb.in)
Auxiliary conductors:		<ul style="list-style-type: none"> • Solid • Finely stranded with end sleeve • Finely stranded without end sleeve • AWG cables, solid or stranded 	 Cage Clamp terminals <ul style="list-style-type: none"> mm² 2 x (0.25 ... 2.5) mm² 2 x (0.25 ... 1.5) mm² 2 x (0.25 ... 2.5) mm² 2 x (24 ... 14)

For tools for opening Cage Clamp terminals see Catalog LV 1, Chapter 3, Accessories and Spare Parts.

Maximum external diameter of the conductor insulation: 3.6 mm.
For conductor cross-sections $\leq 1 \text{ mm}^2$ an "insulation stop" must be used, see Catalog LV 1, Chapter 3, "Accessories and Spare Parts".

¹⁾ When connecting cable lugs according to DIN 46234 for conductor cross-sections of 185 mm² and more and according to DIN 46235 for conductor cross-sections of 240 mm² and more, the 3RT19 66-4EA1 terminal cover must be used more to keep the phase clearance.

²⁾ If two different conductor cross-sections are connected to one clamping point, both cross-sections must lie in the range specified. If identical cross-sections are used, this restriction does not apply.

3RT, 3TB, 3TF Contactors for Switching Motors

3RT10 contactors, 3-pole, 3 ... 250 kW

Contactors	Type Size		3RT10 15 S00	3RT10 16 S00	3RT10 17 S00	3RT10 23 S0	3RT10 24 S0	3RT10 25 S0	3RT10 26 S0
Ⓢ and Ⓤ ratings									
Rated insulation voltage		V AC	600			600			
Uninterrupted current, at 40 °C	• Open and enclosed	A	20			35			
Maximum horsepower ratings (Ⓢ and Ⓤ approved values)									
• Rated power for induction motors at 60 Hz		At 200 V hp	1.5	2	3	2	3	5	7.5
		230 V hp	2	3	3	3	3	5	7.5
		460 V hp	3	5	7.5	5	7.5	10	15
		575 V hp	5	7.5	10	7.5	10	15	20
Short-circuit protection¹⁾ (contactor or overload relay)	• CLASS RK5 fuse	At 600 V kA	5	5	5	5	5	5	5
	• Circuit breakers with overload protection acc. to UL 489	A	60	60	60	70	70	70	100
		A	50	50	50	70	70	70	100
• Combination motor controllers type E acc. to UL 508									
	- At 480 V	Type	--	--	--	3RV10 2			
		A	--	--	--	8	10	16	22
		kA	--	--	--	65	65	65	65
	- At 600 V	Type	--	--	--	3RV10 2			
		A	--	--	--	8	10	12.5	12.5
		kA	--	--	--	25	25	25	25
NEMA/EEMAC ratings									
NEMA/EEMAC size		hp	--		0	--			1
• Uninterrupted current	- Open	A	--		18	--			27
	- Enclosed	A	--		18	--			27
• Rated power for induction motors at 60 Hz		At 200 V hp	--		3	--			7.5
		230 V hp	--		3	--			7.5
		460 V hp	--		5	--			10
		575 V hp	--		5	--			10
Overload relay	• Type	A	3RU11 16			3RU11 2			
	• Setting range	A	0.11 ... 12			1.8 ... 25			

Contactors	Type Size		3RT10 34 S2	3RT10 35 S2	3RT10 36 S2	3RT10 44 S3	3RT10 45 S3	3RT10 46 S3
Ⓢ and Ⓤ ratings								
Rated insulation voltage		V AC	600			600		
Uninterrupted current, at 40 °C	• Open and enclosed	A	45	55	50	90	105	105
Maximum horsepower ratings (Ⓢ and Ⓤ approved values)								
• Rated power for induction motors at 60 Hz		At 200 V hp	10	10	15	20	25	30
		230 V hp	10	15	15	25	30	30
		460 V hp	25	30	40	50	60	75
		575 V hp	30	40	50	60	75	100
Short-circuit protection¹⁾ (contactor or overload relay)	• CLASS RK5 fuse	At 600 V kA	5	5	5	10	10	10
	• Circuit breakers with overload protection acc. to UL 489	A	125	150	200	250	300	350
		A	125	150	200	250	300	400
• Combination motor controllers type E acc. to UL 508								
	- At 480 V	Type	3RV10 3			3RV10 4		
		A	32	40	50	63	75	100
		kA	65	65	65	65	65	65
	- At 600 V	Type	3RV10 4			3RV10 4		
		A	32	40	50	63	75	75
		kA	25	25	25	30	30	30
NEMA/EEMAC ratings								
NEMA/EEMAC size		hp	--		2	--		3
• Uninterrupted current	- Open	A	--		45	--		90
	- Enclosed	A	--		45	--		90
• Rated power for induction motors with 60 Hz		At 200 V hp	--		10	--		25
		230 V hp	--		15	--		30
		460 V hp	--		25	--		50
		575 V hp	--		25	--		50
Overload relay	• Type	A	3RU11 3			3RU11 4		
	• Setting range	A	5.5 ... 50			18 ... 100		

¹⁾ For more information about short-circuit values, e. g. for protection against short-circuit currents, see the UL guides (Order No.: A5E02118883 for German) or UL reports (<http://www.siemens.com/lowvoltage/support>) for the individual devices.

3RT, 3TB, 3TF Contactors for Switching Motors

3RT10 contactors, 3-pole, 3 ... 250 kW

Contactors	Size	S00 Screw terminals and Cage Clamp terminals	S0 ... S12 Screw terminals and Cage Clamp terminals	Screw terminals and Cage Clamp terminals
		Integrated or snap-on auxiliary switch block	1- and 4-pole snap-on auxiliary switch block	Laterally mountable auxiliary switch block

UL and IEC ratings of the auxiliary contacts

Rated voltage	V AC	600	600	600
Switching capacity		A 600, Q 600	A 600, Q 600	A 300, Q 300
	• Uninterrupted current at 240 V AC	A	10	10

Contactors	Type Size	3RT10 54 S6	3RT10 55 S6	3RT10 56 S6	3RT10 64 S10	3RT10 65 S10	3RT10 66 S10
------------	--------------	----------------	----------------	----------------	-----------------	-----------------	-----------------

UL and IEC ratings

Rated insulation voltage	V AC	600			600				
Uninterrupted current, at 40 °C	• Open and enclosed	A	140	195	195	250	330	330	
Maximum horsepower ratings (UL and IEC approved values)									
• Rated power for induction motors at 60 Hz			At 200 V hp	40	50	60	60	75	100
			230 V hp	50	60	75	75	100	125
			460 V hp	100	125	150	150	200	250
			575 V hp	125	150	200	200	250	300
Short-circuit protection¹⁾									
			At 600 V kA	10	10	10	10	18	18
	• CLASS RK5/L fuse	A	A	450	500	500	700	800	800
	• Circuit breakers with overload protection acc. to UL 489	A	A	350	450	500	500	700	800
NEMA/EEMAC ratings									
NEMA/EEMAC size		hp	--	4	--	--	--	--	5
• Uninterrupted current	- Open	A	--	150	--	--	--	--	300
	- Enclosed	A	--	135	--	--	--	--	270
• Rated power for induction motors with 60 Hz		At 200 V hp	--	40	--	--	--	--	75
		230 V hp	--	50	--	--	--	--	100
		460 V hp	--	100	--	--	--	--	200
		575 V hp	--	100	--	--	--	--	200
Overload relay	• Type		3RB20 56			3RB20 66			

Contactors	Type Size	3RT10 75 S12	3RT10 76 S12
------------	--------------	-----------------	-----------------

UL and IEC ratings

Rated insulation voltage	V AC	600		
Uninterrupted current, at 40 °C	• Open and enclosed	A	400	540
Maximum horsepower ratings (UL and IEC approved values)				
• Rated power for induction motors at 60 Hz		At 200 V hp	125	150
		230 V hp	150	200
		460 V hp	300	400
		575 V hp	400	500
Short-circuit protection¹⁾				
		At 600 V kA	18	30
	• CLASS L fuse	A	1000	1200
	• Circuit breakers with overload pro- tection acc. to UL 489	A	900	900
NEMA/EEMAC ratings				
NEMA/EEMAC size		hp	--	6
• Uninterrupted current	- Open	A	--	600
	- Enclosed	A	--	540
• Rated power for induction motors at 60 Hz		At 200 V hp	--	150
		230 V hp	--	200
		460 V hp	--	400
		575 V hp	--	400
Overload relay	• Type		3RB20 66	

¹⁾ For more information about short-circuit values, e. g. for protection against short-circuit currents, see the UL guide (Order No.: A5E02118883 for German) or UL reports (<http://www.siemens.com/lowvoltage/support>) for the individual devices.

Overview

- 3RT12 vacuum contactors for switching motors

Operating mechanism types

Two types of solenoid operation are available:

- Conventional operating mechanism, version 3RT12...A
- Solid-state operating mechanism, version 3RT12...N

UC operation

The contactors can be operated with AC (40 to 60 Hz) as well as with DC.

Withdrawable coils

For simple coil replacement, e. g. if the application is replaced, the magnetic coil can be pulled out upwards after the release mechanism has been actuated and can be replaced by any other coil of the same size.

Auxiliary contact complement

The contactors can be fitted with up to 8 lateral auxiliary contacts (identical auxiliary switch blocks from S0 to S12). Of these, no more than 4 are permitted to be NC contacts.

Function

3RT12 vacuum contactors

In contrast with the 3RT10 contactors – the main contacts operate in air under atmospheric conditions – the contact gaps of the 3RT12 vacuum contactors are contained in hermetically enclosed vacuum contact tubes. Neither arcs nor arcing gases are produced. The particular benefit of 3RT12 vacuum contactors, however, is that their electrical endurance is at least twice as long as that of 3RT10 contactors. They are therefore particularly well suited to frequent switching in jogging/mixed operation, for example in crane control systems.

Advantages:

- Very long electrical endurance
- High short-time loading capacity for heavy starting
- No reduction of rated operational currents up to 1000 V
- No open arcs, no arcing gases, i. e. no minimum clearances from grounded parts required either
- Longer maintenance intervals
- Increased plant availability

Notes on operation:

- *Switching motors with operational voltages $U_e > 500$ V: To damp overvoltages and protect the motor coil insulation against reignition when switching off induction motors, it is recommended to connect the 3RT19 66-1PV surge suppression module – RC varistor – to the outgoing side (2/T1, 4/T2, 6/T3) of the contactors (accessory). This additional equipment is not required for use in circuits with converters. It could be destroyed by the voltage peaks and harmonics which are generated.*
- *Switching DC voltage: Vacuum contactors are basically unsuitable for switching DC voltage.*

Contactors with conventional operating mechanism

3RT1...-A version:

The magnetic coil is switched directly on and off with the control supply voltage U_s by way of terminals A1/A2.

Multi-voltage range for the control supply voltage U_s :

Several closely adjacent control supply voltages, available around the world, are covered by just one coil, for example 110-115-120-127 V AC/DC or 220-230-240 V AC/DC.

In addition, allowance is also made for a coil operating range of 0.8 times the lower ($U_{s\ min}$) and 1.1 times the upper ($U_{s\ max}$) rated control supply voltage within which the contactor switches reliably and no thermal overloading occurs.

Contactors with solid-state operating mechanism

The magnetic coil is supplied selectively with the power required for reliable switching and holding by upstream control electronics.

- Wide voltage range for the control supply voltage U_s : Compared with the conventional operating mechanism, the solid-state operating mechanism covers an even broader range of control supply voltages used worldwide within one coil variant. For example, the coil for 200 to 277 V UC ($U_{s\ min}$ to $U_{s\ max}$) covers the voltages 200-208-220-230-240-254-277 V used worldwide.
- Extended operating range 0.7 to $1.25 \times U_s$: The wide range of the rated control supply voltage and the additional coil operating range of $0.8 \times U_{s\ min}$ to $1.1 \times U_{s\ max}$ results in an extended coil tolerance of at least 0.7 to $1.25 \times U_s$ for the most common control supply voltages 24, 110 and 230 V for which the contactors operate reliably.
- Bridging temporary voltage dips: Control voltage failures dipping to 0 V (at A1/A2) are bridged for up to approx. 25 ms to avoid unintentional tripping.
- Defined ON and OFF thresholds: For voltages of $\geq 0.8 \times U_{s\ min}$ and higher, the electronics will reliably switch the contactors on and off $\leq 0.5 \times U_{s\ min}$. The hysteresis in the switching thresholds prevents the main contacts from chattering as well as increased wear or welding when operated in weak, unstable networks. This also prevents thermal overloading of the contactor coil if the voltage applied is too low (contactor does not close properly and is continuously operated with overexcitation).
- Low control power consumption when closing and in the closed state.

Electromagnetic compatibility (EMC)

The contactors with solid-state operating mechanism conform to the requirements for operation in industrial plants.

- Interference immunity
 - Burst (IEC 61000-4-4): 4 kV
 - Surge (IEC 61000-4-5): 4 kV
 - Electrostatic discharge, ESD (IEC 61000-4-2): 8/15 kV
 - Electromagnetic field (IEC 61000-4-3): 10 V/m
- Emitted interference
 - Limit value class A according to EN 55011

Note:

In connection with converters, the control cables must be routed separately from the load cables to the converter.

3RT, 3TB, 3TF Contactors for Switching Motors

3RT12 vacuum contactors, 3-pole, 110 ... 250 kW

3RT1...-N version: for 24 V DC PLC output

2 control options:

- Control without a coupling link directly through a 24 V DC/≥ 30 mA PLC output (EN 61131-2). Connection by means of 2-pole plug-in connection. The screwless spring-type connection is part of the scope of supply. The control supply voltage which supplies the solenoid operating mechanism must be connected to A1/A2.

Note: Before start-up, the slide switch for PLC operation must be moved to the "PLC ON" position (setting ex works: "PLC OFF").

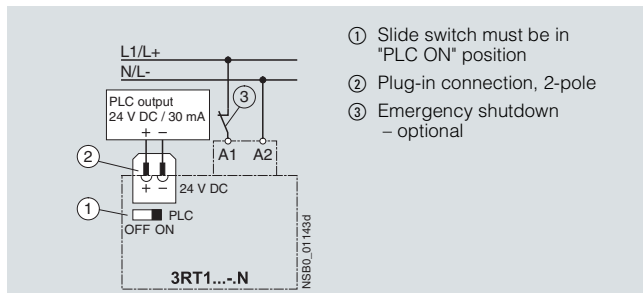

- Conventional control by applying the control supply voltage at A1/A2 through a switching contact.

Note:

The slide switch must be in the "PLC OFF" position (= setting ex works).

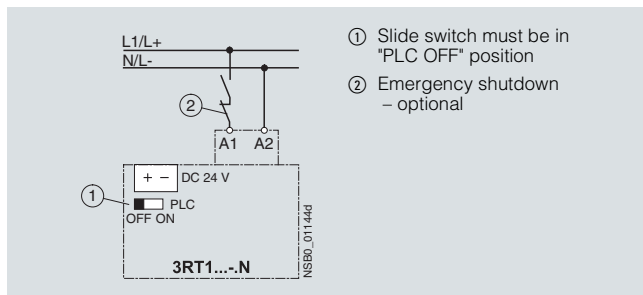

Vacuum contactors S10 and S12 contact erosion indication

If the contact erosion indicator on the contactor head part indicates an excessive erosion of the vacuum contact tubes (indicating line is on level with the tool symbol), the tubes must be replaced.

To ensure greater reliability, it is recommended to replace all 3 contact tubes.

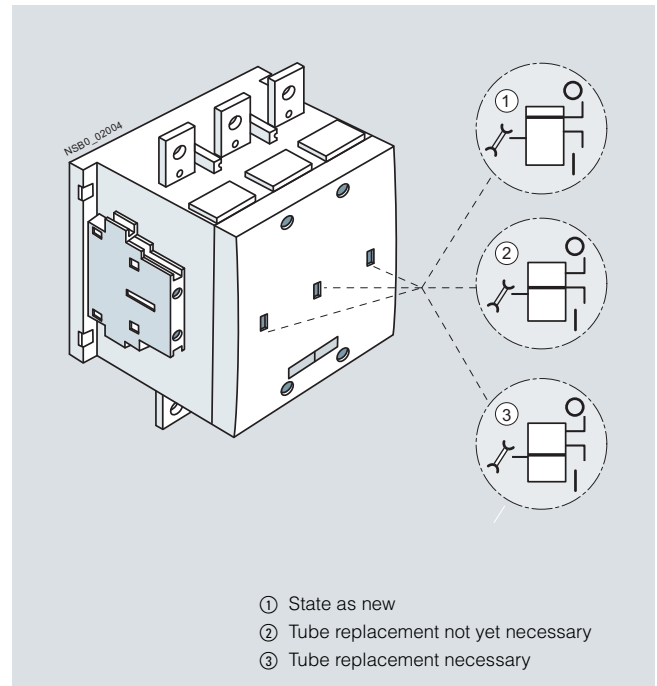

Technical specifications

Contactor	Type Size	3RT12 64 S10	3RT12 65 S10	3RT12 66 S10
General data				
Permissible mounting position The contactors are designed for operation on a vertical mounting surface.				
Mechanical endurance	Operating cycles	10 million		
Electrical endurance		1)		
Rated insulation voltage U_i (degree of pollution 3)	V	1000		
Rated impulse withstand voltage U_{imp}	kV	8		
Protective separation between the coil and the main contacts acc. to EN 60947-1, Appendix N	V	690		
Mirror contacts A mirror contact is an auxiliary NC contact that cannot be closed simultaneously with a NO main contact.		Yes, acc. to EN 60947-4-1, Appendix F		
Permissible ambient temperature	<ul style="list-style-type: none"> During operation During storage 	°C	-25 ... +60/+55 with AS-Interface	
		°C	-55 ... +80	
Degree of protection acc. to EN 60947-1, Appendix C		IP00/open, coil assembly IP20		
Touch protection acc. to EN 50274		Finger-safe with cover		
Shock resistance	<ul style="list-style-type: none"> Rectangular pulse Sine pulse 	g/ms	8.5/5 and 4.2/10	
		g/ms	13.4/5 and 6.5/10	
Conductor cross-sections		2)		
Electromagnetic compatibility (EMC)		3)		

1) For endurance of the main contacts see page 3/19.

2) For conductor cross-sections see page 3/59.

3) For electromagnetic compatibility (EMC) see page 3/12.

3RT, 3TB, 3TF Contactors for Switching Motors

3RT12 vacuum contactors, 3-pole, 110 ... 250 kW

Contactors	Type Size	3RT12 64 S10	3RT12 65 S10	3RT12 66 S10
Short-circuit protection				
Main circuit				
Fuse links, gL/gG				
LV HRC 3NA, DIAZED 5SB, NEOZED 5SE				
acc. to IEC 60947-4-1/				
EN 60947-4-1				
	• Type of coordination "1"	A	500	
	• Type of coordination "2"	A	500	
	• Weld-free ¹⁾	A	400	
Auxiliary circuit				
	• Fuse links gL/gG	A	10	
DIAZED 5SB, NEOZED 5SE				
(weld-free protection for $I_k \geq 1$ kA)				
• Or miniature circuit breakers with C characteristic				
(short-circuit current I_k 400 A)				
¹⁾ Test conditions according to IEC 60947-4-1.				

Contactors	Type Size	3RT12 64 S10	3RT12 65 S10	3RT12 66 S10
Control				
Operating range of the solenoid AC/DC (UC)				
$0.8 \times U_{s \min} \dots 1.1 \times U_{s \max}$				
Power consumption of the solenoid				
(when coil is cool and rated range $U_{s \min} \dots U_{s \max}$)				
• Conventional operating mechanism				
- AC operation	Closing at $U_{s \min}$	VA/p.f.	530/0.9	
	Closing at $U_{s \max}$	VA/p.f.	630/0.9	
	Closed at $U_{s \min}$	VA/p.f.	6.1/0.9	
	Closed at $U_{s \max}$	VA/p.f.	7.4/0.9	
- DC operation	Closing at $U_{s \min}$	W	580	
	Closing at $U_{s \max}$	W	700	
	Closed at $U_{s \min}$	W	6.8	
	Closed at $U_{s \max}$	W	8.2	
• Solid-state operating mechanism				
- AC operation	Closing at $U_{s \min}$	VA/p.f.	420/0.8	
	Closing at $U_{s \max}$	VA/p.f.	570/0.8	
	Closed at $U_{s \min}$	VA/p.f.	4.3/0.8	
	Closed at $U_{s \max}$	VA/p.f.	5.6/0.8	
- DC operation	Closing at $U_{s \min}$	W	460	
	Closing at $U_{s \max}$	W	630	
	Closed at $U_{s \min}$	W	3.4	
	Closed at $U_{s \max}$	W	4.2	
PLC control input (EN 61131-2/type 2)				
24 V DC/≤ 30 mA power consumption, (operating range 17 ... 30 V DC)				
Operating times (Total break time = Opening delay + Arcing time)				
• Conventional operating mechanism				
- With $0.8 \times U_{s \min} \dots 1.1 \times U_{s \max}$	Closing delay	ms	30 ... 95	
	Opening delay	ms	40 ... 80	
- For $U_{s \min} \dots U_{s \max}$	Closing delay	ms	35 ... 50	
	Opening delay	ms	50 ... 80	
• Solid-state operating mechanism, actuated via A1/A2				
- With $0.8 \times U_{s \min} \dots 1.1 \times U_{s \max}$	Closing delay	ms	105 ... 145	
	Opening delay	ms	80 ... 100	
- For $U_{s \min} \dots U_{s \max}$	Closing delay	ms	110 ... 130	
	Opening delay	ms	80 ... 100	
• Solid-state operating mechanism, actuated via PLC input				
- With $0.8 \times U_{s \min} \dots 1.1 \times U_{s \max}$	Closing delay	ms	45 ... 80	
	Opening delay	ms	80 ... 100	
- For $U_{s \min} \dots U_{s \max}$	Closing delay	ms	50 ... 65	
	Opening delay	ms	80 ... 100	
• Arcing time				
		ms	10 ... 15	

3RT, 3TB, 3TF Contactors for Switching Motors

3RT12 vacuum contactors, 3-pole, 110 ... 250 kW





Contactors	Type Size	3RT12 64 S10	3RT12 65 S10	3RT12 66 S10
Main circuit				
<i>AC capacity</i>				
Utilization category AC-1				
Switching resistive loads				
• Rated operational currents I_e	At 40 °C up to 1000 V A	330		
	At 60 °C up to 1000 V A	300		
• Rated power for AC loads ¹⁾ P.f. = 0.95 (at 60 °C)	At 230 V kW	113		
	400 V kW	197		
	500 V kW	246		
	690 V kW	340		
	1000 V kW	492		
• Minimum conductor cross-section for loads with I_e	At 40 °C mm ²	185		
	At 60 °C mm ²	185		
Utilization category AC-2 and AC-3				
• Rated operational currents I_e	Up to 1000 V A	225	265	300
• Rated power for slipring or squirrel-cage motors at 50 and 60 Hz	At 230 V kW	73	85	97
	400 V kW	128	151	171
	500 V kW	160	189	215
	690 V kW	223	265	288
	1000 V kW	320	378	428
Thermal load capacity	10 s current ²⁾ A	1800	2120	2400
Power loss per conducting path	At I_e /AC-3 W	9	12	14
Utilization category AC-4 (for $I_a = 6 \times I_e$)				
• Rated operational current I_e	Up to 690 V A	195	230	280
• Rated power for squirrel-cage motors with 50 Hz and 60 Hz	At 400 V kW	110	132	160
• The following applies to a contact endurance of about 200 000 operating cycles:				
- Rated operational currents I_e	Up to 690 V A	97	115	140
	1000 V A	68	81	98
- Rated power for squirrel-cage motors with 50 Hz and 60 Hz	At 230 V kW	30	37	45
	400 V kW	55	65	79
	500 V kW	68	81	98
	690 V kW	94	112	138
	1000 V kW	95	114	140
Utilization category AC-6a				
Switching AC transformers				
Rated operational current I_e				
• For inrush current n = 20	Up to 690 V A	278		
• For inrush current n = 30	Up to 690 V A	185		
Rating P				
• For inrush current n = 20	At 230 V kVA	111		
	400 V kVA	193		
	500 V kVA	241		
	690 V kVA	332		
	1000 V kVA	482		
• For inrush current n = 30	At 230 V kVA	74		
	400 V kVA	128		
	500 V kVA	160		
	690 V kVA	221		
	1000 V kVA	320		
For deviating inrush current factors x, the power must be recalculated as follows: $P_x = P_{n30} \cdot 30/x$				
Utilization category AC-6b				
Switching low-inductance (low-loss, metallized dielectric) AC capacitors				
Ambient temperature 40 °C				
• Rated operational currents I_e	Up to 500 V A	220		
• Rated power for single capacitors or banks of capacitors (minimum inductance of 6 µH between capacitors connected in parallel) at 50 Hz, 60 Hz and	At 230 V kvar	88		
	400 V kvar	152		
	500 V kvar	191		
	690 V kvar	152		
Switching frequency				
Switching frequency z in operating cycles/hour				
• Contactors without overload relays	No-load switching frequency h ⁻¹	2000	2000	
Dependence of the switching frequency z' on the operational current I' and operational voltage U': $z' = z \cdot (I_e/I') \cdot (400 V/U')^{1.5} \cdot 1/h$	AC-1 h ⁻¹	800	750	
	AC-2 h ⁻¹	300	250	
	AC-3 h ⁻¹	750	750	
	AC-4 h ⁻¹	250	250	
• Contactors with overload relays (mean value)	h ⁻¹	60	60	

1) Industrial furnaces and electric heaters with resistance heating, etc. (increased power consumption on heating up taken into account).

2) According to IEC 60947-4-1.
For rated values for various start-up conditions see "Protection Equipment --> Overload Relays".

3RT, 3TB, 3TF Contactors for Switching Motors

3RT12 vacuum contactors, 3-pole, 110 ... 250 kW

Contactors	Type Size	3RT12 6. S10		
Main conductor cross-sections				
Front clamping point connected 	Main conductors: With 3RT19 66-4G box terminal		 Screw terminals	
	<ul style="list-style-type: none"> Finely stranded with end sleeve Finely stranded without end sleeve Stranded AWG cables, solid or stranded Ribbon cable conductors (number x width x thickness) 	mm ² mm ² mm ² AWG mm		70 ...240 70 ...240 95 ...300 3/0 ...600 kcmil Min. 6 x 9 x 0.8, max. 20 x 24 x 0.5
Rear clamping point connected 	<ul style="list-style-type: none"> Finely stranded with end sleeve Finely stranded without end sleeve Stranded AWG cables, solid or stranded Ribbon cable conductors (number x width x thickness) 		mm ² mm ² mm ² AWG mm Min. 6 x 9 x 0.8, max. 20 x 24 x 0.5	
	<ul style="list-style-type: none"> Finely stranded with end sleeve Finely stranded without end sleeve Stranded AWG cables, solid or stranded Ribbon cable conductors (number x width x thickness) Terminal screws - Tightening torque 		mm ² mm ² mm ² AWG mm Nm	120 ...185 120 ...185 120 ...240 250 ...500 kcmil Min. 2 x 50, max. 2 x 185 Min. 2 x 50, max. 2 x 185 Min. 2 x 70, max. 2 x 240 Min. 2 x 1/0, max. 2 x 500 kcmil Max. 2 x (20 x 24 x 0.5) M12 (hexagon socket, A/F 5) 20 ... 22 (180 ... 195 lb.in)
Both clamping points connected 	Main conductors: Without box terminal/ busbar connection		mm ² mm ² mm ² AWG mm Nm M12 (hexagon socket, A/F 5) 14 ... 24 (124 ... 210 lb.in)	
	<ul style="list-style-type: none"> Finely stranded with cable lug¹⁾ Stranded with cable lug¹⁾ AWG cables, solid or stranded Connecting bar (max. width) Terminal screws - Tightening torque 	mm ² mm ² AWG mm Nm		50 ...240 70 ...240 2/0 ...500 kcmil 25 M12 (hexagon socket, A/F 5) 14 ... 24 (124 ... 210 lb.in)
Auxiliary conductors:		<ul style="list-style-type: none"> Solid Finely stranded with end sleeve AWG cables, solid or stranded Terminal screws - Tightening torque 	mm ² mm ² AWG Nm	2 x (0.5 ... 1.5) ²⁾ ; 2 x (0.75 ... 2.5) ²⁾ acc. to IEC 60947; max. 2 x (0.75 ... 4) 2 x (0.5 ... 1.5) ²⁾ ; 2 x (0.75 ... 2.5) ²⁾ 2 x (18 ... 14) M3 (PZ 2) 0.8 ... 1.2 (7 ... 10.3 lb.in)

¹⁾ When connecting cable lugs according to DIN 46234 for conductor cross-sections of 185 mm² and more and according to DIN 46235 for conductor cross-sections of 240 mm² and more, the 3RT19 66-4EA1 terminal cover must be used more to keep the phase clearance.

²⁾ If two different conductor cross-sections are connected to one clamping point, both cross-sections must lie in the range specified. If identical cross-sections are used, this restriction does not apply.

3RT, 3TB, 3TF Contactors for Switching Motors

3RT12 vacuum contactors, 3-pole, 110 ... 250 kW

Contactors	Type Size		3RT12 75 S12	3RT12 76 S12
General data				
Permissible mounting position The contactors are designed for operation on a vertical mounting surface.				
Mechanical endurance			Operat- ing cycles	10 million
Electrical endurance				1)
Rated insulation voltage U_i (degree of pollution 3)			V	1000
Rated impulse withstand voltage U_{imp}			kV	8
Protective separation between the coil and the main contacts acc. to EN 60947-1, Appendix N			V	690
Mirror contacts A mirror contact is an auxiliary NC contact that cannot be closed simultaneously with a NO main contact.				Yes, acc. to EN 60947-4-1, Appendix F
Permissible ambient temperature			°C	-25 ... +60/+55 with AS-Interface
			°C	-55 ... +80
Degree of protection acc. to EN 60947-1, Appendix C				IP00/open, coil assembly IP20
Touch protection acc. to EN 50274				Finger-safe with cover
Shock resistance				
			g/ms	8.5/5 and 4.2/10
			g/ms	13.4/5 and 6.5/10
Conductor cross-sections				2)
Electromagnetic compatibility (EMC)				3)
Short-circuit protection				
Main circuit				
Fuse links, gL/gG				
LV HRC 3NA, DIAZED 5SB, NEOZED 5SE				
acc. to IEC 60947-4-1/ EN 60947-4				
			A	800
• Type of coordination "1"			A	800
• Type of coordination "2"			A	500
• Weld-free ⁴⁾				
Auxiliary circuit				
• Fuse links gL/gG DIAZED 5SB, NEOZED 5SE (weld-free protection for $I_k \geq 1$ kA)			A	10
• Or miniature circuit breakers with C characteristic (short-circuit current $I_k < 400$ A)				

1) See endurance of the main contacts on page 3/19.

2) See conductor cross-sections on page 3/63.

3) See Electromagnetic Compatibility (EMC) on page 3/12.

4) Test conditions according to IEC 60947-4-1.

3RT, 3TB, 3TF Contactors for Switching Motors

3RT12 vacuum contactors, 3-pole, 110 ... 250 kW

Contactors	Type Size		3RT12 75 S12	3RT12 76 S12
Control				
Operating range of the solenoid	AC/DC (UC)		$0.8 \times U_{s \min} \dots 1.1 \times U_{s \max}$	
Power consumption of the solenoid (when coil is cool and rated range $U_{s \min} \dots U_{s \max}$)				
• Conventional operating mechanism				
- AC operation	Closing at $U_{s \min}$	VA/p.f.	700/0.9	
	Closing at $U_{s \max}$	VA/p.f.	830/0.9	
	Closed at $U_{s \min}$	VA/p.f.	7.6/0.9	
	Closed at $U_{s \max}$	VA/p.f.	9.2/0.9	
- DC operation	Closing at $U_{s \min}$	W	770	
	Closing at $U_{s \max}$	W	920	
	Closed at $U_{s \min}$	W	8.5	
	Closed at $U_{s \max}$	W	10	
• Solid-state operating mechanism				
- AC operation	Closing at $U_{s \min}$	VA/p.f.	560/0.8	
	Closing at $U_{s \max}$	VA/p.f.	750/0.8	
	Closed at $U_{s \min}$	VA/p.f.	5.4/0.8	
	Closed at $U_{s \max}$	VA/p.f.	7/0.8	
- DC operation	Closing at $U_{s \min}$	W	600	
	Closing at $U_{s \max}$	W	800	
	Closed at $U_{s \min}$	W	4	
	Closed at $U_{s \max}$	W	5	
PLC control input (EN 61131-2/type 2)			24 V DC/≤ 30 mA power consumption, (operating range 17 ... 30 V DC)	
Operating times (Total break time = Opening delay + Arcing time)				
• Conventional operating mechanism				
- With $0.8 \times U_{s \min} \dots 1.1 \times U_{s \max}$	Closing delay	ms	45 ... 100	
	Opening delay	ms	60 ... 100	
- For $U_{s \min} \dots U_{s \max}$	Closing delay	ms	50 ... 70	
	Opening delay	ms	70 ... 100	
• Solid-state operating mechanism, actuated via A1/A2				
- With $0.8 \times U_{s \min} \dots 1.1 \times U_{s \max}$	Closing delay	ms	120 ... 150	
	Opening delay	ms	80 ... 100	
- For $U_{s \min} \dots U_{s \max}$	Closing delay	ms	125 ... 150	
	Opening delay	ms	80 ... 100	
• Solid-state operating mechanism, actuated via PLC input				
- With $0.8 \times U_{s \min} \dots 1.1 \times U_{s \max}$	Closing delay	ms	60 ... 90	
	Opening delay	ms	80 ... 100	
- For $U_{s \min} \dots U_{s \max}$	Closing delay	ms	65 ... 80	
	Opening delay	ms	80 ... 100	
• Arcing time				
		ms	10 ... 15	
Main circuit				
AC capacity				
Utilization category AC-1				
Switching resistive loads				
• Rated operational currents I_e	At 40 °C up to 1000 V	A	610	
	At 60 °C up to 1000 V	A	550	
• Rated power for AC loads ¹⁾	At 230 V	kW	208	
P.f. = 0.95 (at 60 °C)	400 V	kW	362	
	500 V	kW	452	
	690 V	kW	624	
	1000 V	kW	905	
• Minimum conductor cross-section for loads with I_e	At 40 °C	mm ²	2 x 185	
	At 60 °C	mm ²	2 x 185	
Utilization category AC-2 and AC-3				
• Rated operational currents I_e	Up to 1000 V	A	400	500
• Rated power for slipping or squirrel-cage motors at 50 and 60 Hz	At 230 V	kW	132	164
	400 V	kW	231	291
	500 V	kW	291	363
	690 V	kW	400	507
	1000 V	kW	578	728
Thermal load capacity	10 s current ²⁾	A	3200	4000
Power loss per conducting path	At I_e /AC-3	W	21	32

¹⁾ Industrial furnaces and electric heaters with resistance heating, etc. (increased power consumption on heating up taken into account).

²⁾ According to IEC 60947-4-1.

For rated values for various start-up conditions see "Protection Equipment → Overload Relays".





3RT, 3TB, 3TF Contactors for Switching Motors

3RT12 vacuum contactors, 3-pole, 110 ... 250 kW

Contactor	Type Size	3RT12 75 S12		3RT12 76 S12
Main circuit				
AC capacity				
Utilization category AC-4 (for $I_a = 6 \times I_e$)				
• Rated operational current I_e	Up to 690 V	A	350	430
• Rated power for squirrel-cage motors with 50 Hz and 60 Hz	At 400 V	kW	200	250
• The following applies to a contact endurance of about 200 000 operating cycles:				
- Rated operational currents I_e	690 V	A	175	215
	1000 V	A	123	151
• Rated power for squirrel-cage motors with 50 Hz and 60 Hz	At 230 V	kW	56	70
	400 V	kW	98	122
	500 V	kW	124	153
	690 V	kW	172	212
	1000 V	kW	183	217
Utilization category AC-6a switching AC transformers				
• Rated operational current I_e				
- For inrush current $n = 20$	Up to 690 V	A	419	
- For inrush current $n = 30$	Up to 690 V	A	279	
• Rating P				
- For inrush current $n = 20$	At 230 V	kVA	167	
	400 V	kVA	290	
	500 V	kVA	363	
	690 V	kVA	501	
	1000 V	kVA	726	
- For inrush current $n = 30$	At 230 V	kVA	111	
	400 V	kVA	193	
	500 V	kVA	241	
	690 V	kVA	332	
	1000 V	kVA	482	
For deviating inrush current factors x , the power must be recalculated as follows: $P_x = P_{n30} \cdot 30/x$				
Utilization category AC-6b Switching low-inductance (low-loss, metallized dielectric) AC capacitors Ambient temperature 40 °C				
• Rated operational currents I_e	Up to 500 V	A	407	
• Rated power for single capacitors or banks of capacitors (minimum inductance of 6 µH between capacitors connected in parallel) at 50 Hz, 60 Hz and	At 230 V	kvar	162	
	400 V	kvar	282	
	500 V	kvar	352	
	690 V	kvar	282	
Switching frequency				
Switching frequency z in operating cycles/hour				
• Contactors without overload relays	No-load switching frequency	h^{-1}	2000	
Dependence of the switching frequency z' on the operational current I' and operational voltage U' : $z' = z \cdot (I_e/I') \cdot (400 V/U')^{1.5} \cdot 1/h$				
	AC-1	h^{-1}	700	
	AC-2	h^{-1}	250	
	AC-3	h^{-1}	750	
	AC-4	h^{-1}	250	
• Contactors with overload relays (mean value)		h^{-1}	60	

3RT, 3TB, 3TF Contactors for Switching Motors

3RT12 vacuum contactors, 3-pole, 110 ... 250 kW

Contactors	Type Size	3RT12 7. S12	
Conductor cross-sections			
Front clamping point connected 	Main conductors: With 3RT19 66-4G box terminal	<ul style="list-style-type: none"> Finely stranded with end sleeve mm² Finely stranded without end sleeve mm² Stranded mm² AWG cables, solid or stranded AWG Ribbon cable conductors (number x width x thickness) mm 	 Screw terminals 70 ... 240 70 ... 240 95 ... 300 3/0 ... 600 kcmil Min. 6 x 9 x 0.8, max. 20 x 24 x 0.5
	Rear clamping point connected 	<ul style="list-style-type: none"> Finely stranded with end sleeve mm² Finely stranded without end sleeve mm² Stranded mm² AWG cables, solid or stranded AWG Ribbon cable conductors (number x width x thickness) mm 	120 ... 185 120 ... 185 120 ... 240 250 ... 500 kcmil Min. 6 x 9 x 0.8, max. 20 x 24 x 0.5
Both clamping points connected 	<ul style="list-style-type: none"> Finely stranded with end sleeve mm² Finely stranded without end sleeve mm² Stranded mm² AWG cables, solid or stranded AWG Ribbon cable conductors (number x width x thickness) mm 	Min. 2 x 50, max. 2 x 185 Min. 2 x 50, max. 2 x 185 Min. 2 x 70, max. 2 x 240 Min. 2 x 2/0, max. 2 x 500 kcmil Max. 2 x (20 x 24 x 0.5)	
	<ul style="list-style-type: none"> Terminal screws - Tightening torque Nm 	M12 (hexagon socket, A/F 5) 20 ... 22 (180 ... 195 lb.in)	
	Main conductors: Without box terminal/ busbar connection	<ul style="list-style-type: none"> Finely stranded with cable lug¹⁾ mm² Stranded with cable lug¹⁾ mm² AWG cables, solid or stranded AWG Connecting bar (max. width) mm Terminal screws - Tightening torque Nm 	50 ... 240 70 ... 240 2/0 ... 500 kcmil 25 M10 x 30 (hexagon socket, A/F 17) 14 ... 24 (124 ... 240 lb.in)
	Auxiliary conductors:	<ul style="list-style-type: none"> Solid mm² Finely stranded with end sleeve mm² AWG cables, solid or stranded AWG Terminal screws - Tightening torque Nm 	2 x (0.5 ... 1.5) ²⁾ ; 2 x (0.75 ... 2.5) ²⁾ acc. to IEC 60947; max. 2 x (0.75 ... 4) 2 x (0.5 ... 1.5) ²⁾ ; 2 x (0.75 ... 2.5) ²⁾ 2 x (18 ... 14) M3 (PZ 2) 0.8 ... 1.2 (7 ... 10.3 lb.in)
¹⁾ When connecting cable lugs to DIN 46234, the 3RT19 66-4EA1 terminal cover must be used for conductor cross-sections of 240 mm ² and more as well as DIN 46235 for conductor cross-sections of 185 mm ² and more to keep the phase clearance.		²⁾ If two different conductor cross-sections are connected to one clamping point, both cross-sections must lie in the range specified. If identical cross-sections are used, this restriction does not apply.	

Contactors	Type Size	3RT12 64 S10	3RT12 65 S10	3RT12 66 S10	3RT12 75 S12	3RT12 76 S12
Ⓢ and Ⓛ ratings						
Rated insulation voltage	V AC	600			600	
Uninterrupted current, at 40 °C	• Open and enclosed	330			540	
Maximum horsepower ratings (Ⓢ and Ⓛ approved values)						
• Rated power for induction motors at 60 Hz	At 200 V	hp	60	75	100	125
	230 V	hp	75	100	125	150
	460 V	hp	150	200	250	300
	575 V	hp	200	250	300	400
Short-circuit protection¹⁾		kA	10	18	18	30
	• CLASS L fuse	A	700	800	800	1200
	• Circuit breakers acc. to UL 489	A	500	700	900	1000
NEMA/EEMAC ratings						
• Uninterrupted current	NEMA/EEMAC size	hp	--	--	5	--
	- Open	A	--	--	300	--
	- Enclosed	A	--	--	270	--
• Rated power for induction motors at 60 Hz	At 200 V	hp	--	--	75	--
	230 V	hp	--	--	100	--
	460 V	hp	--	--	200	--
	575 V	hp	--	--	200	--
Overload relay	• Type	3RB20 66			3RB20 66	

¹⁾ For more information about short-circuit values, e. g. for protection against short-circuit currents, see the UL guide (Order No.: A5E02118883 for German) or UL reports (<http://www.siemens.com/lowvoltage/support>) for the individual devices.

3RT, 3TB, 3TF Contactors for Switching Motors

3TF6 vacuum contactors, 3-pole, 335 ... 450 kW

Overview

IEC 60947-4-1, EN 60947-4-1 (VDE 0660 Part 102)

The 3TF68/69 contactors are climate-proof. They are finger-safe according to EN 50274. Terminal covers may have to be fitted onto the connecting bars, depending on the configuration with other devices (see [Accessories and Spare Parts](#)).

Function

Main contacts

Contact erosion indication with 3TF68/69 vacuum contactors

The contact erosion of the vacuum interrupters can be checked during operation with the help of 3 white double slides on the contactor base. If the distance indicated by one of the double slides is < 0.5 mm while the contactor is in the closed position, the vacuum interrupter must be replaced. To ensure maximum reliability, it is recommended to replace all 3 vacuum interrupters.

Auxiliary contacts

Contact reliability

The auxiliary contacts are suitable for solid-state circuits

- With currents ≥ 1 mA
- And voltages from 17 V.

Surge suppression

Control circuit

Protection of coils against overvoltages:

AC operation

- Fitted with varistors as standard

DC operation

Retrofitting options:

- With varistors

If TF68/TF69 is to be used for DC operation, an additional reversing contactor is required; this is included in the scope of supply in the same packaging as the vacuum contactor.

Electromagnetic compatibility

3TF68/69...C contactors for AC operation are fitted with an electronically controlled solenoid operating mechanism with a high interference immunity.

Contactors type	Rated control supply voltage U_s	Overvoltage type (IEC 60801)	Degree of severity (IEC 60801)	Overvoltage strength
3TF68 44-C.., 3TF69 44-C..	110 ... 132 V	Burst	3	2 kV
		Surge	4	6 kV
	200 ... 277 V	Burst	4	4 kV
		Surge	4	5 kV
	380 ... 600 V	Burst	4	4 kV
		Surge	4	6 kV

Note:

During operation in installations in which the emitted interference limits cannot be observed, e. g. when used for output contactors in converters, 3TF68/69...Q contactors without a main conductor path circuit are recommended (see description below).

Application

The standard 3TF68...C and 3TF69...C contactors with electronically controlled contactor mechanism, have high resistance to electromagnetic interference.

The 3TF68...Q and 3TF69...Q contactors have been designed for use in installations in which the AC control supply voltage is subject to very high levels of interference.

Causes for such interference can be, for example:

- Frequency converters which are operated nearby can cause periodic overvoltages at the control level of the contactors.
- High-energy pulses caused by switching operations and atmospheric discharges can cause interference on the control cables.

To reduce interference voltages caused by frequency converters, the manufacturer recommends the use of e. g. input filters, output filters, grounding or shielding in the installation.

Further measures that should be applied for overvoltage damping:

- Feeding the contactors using control transformer according to EN 60204 - rather than directly from the network
- Use of surge arresters, if required

For operating conditions where there are high interference voltages and no measures that reduce interference voltage coupling to the control voltage level have been taken, use of 3TF68...Q and 3TF69...Q contactors is highly recommended.

Version

The magnetic systems of the 3TF68...Q and 3TF69...Q contactors for AC operation are equipped with rectifiers for DC economy circuit.

A 3TC44 reversing contactor with a mounted series resistor is used to switch to the holding excitation.

The reversing contactor can be fitted separately. The reversing contactors is connected to the 3TF6 main contactor by means of a one-meter connecting cable with plug-in connectors (see [page 3/239](#)).

Connection

Control circuit

The rectifier bridge is connected to varistors for protection against overvoltages. The built-in rectifier bridge affords sufficient protection for the coils.

Main circuit

As standard 3TF6 contactors with integrated RC varistors.

Protection of the main current paths

An integrated RC varistor connection for the main current paths of the contactors dampens the switching overvoltage rises to safe values. This prevents multiple restriking.

The operator of an installation can therefore rest assured that the motor winding cannot be damaged by switching overvoltages with steep voltage rises.

Note:

The overvoltage damping circuit is not required if 3TF68/69 contactors are used in circuits with DC choppers, frequency converters or speed-variable operating mechanisms, for example. It could be damaged by the voltage peaks and harmonics which are generated. This may cause phase-to-phase short-circuits in the contactors.

Solution: Order special contactor version without overvoltage damping. The Order No. must include "-Z" and the order code "A02". Without additional price.

3RT, 3TB, 3TF Contactors for Switching Motors

3TF6 vacuum contactors, 3-pole, 335 ... 450 kW

Technical specifications

Contactors	Type	3TF68 and 3TF69	
Rated data of the auxiliary contacts			
Rated insulation voltage U_i (degree of pollution 3)	V	690	
Continuous thermal current $I_{th} = \text{Rated operational current } I_e/\text{AC-12}$	A	10	
AC load			
Rated operational current $I_e/\text{AC-15/AC-14}$ • For rated operational voltage U_e			
	24 V A	10	
	110 V A	10	
	125 V A	10	
	220 V A	6	
	230 V A	5.6	
	380 V A	4	
	400 V A	3.6	
	500 V A	2.5	
	660 V A	2.5	
	690 V A	2.3	
DC load			
Rated operational current $I_e/\text{DC-12}$ • For rated operational voltage U_e			
	24 V A	10	
	60 V A	10	
	110 V A	3.2	
	125 V A	2.5	
	220 V A	0.9	
	440 V A	0.33	
	600 V A	0.22	
Rated operational current $I_e/\text{DC-13}$ • For rated operational voltage U_e			
	24 V A	10	
	60 V A	5	
	110 V A	1.14	
	125 V A	0.98	
	220 V A	0.48	
	440 V A	0.13	
	600 V A	0.07	
Ⓢ and Ⓛ ratings of the auxiliary contacts			
Rated voltage	V AC, max.	600	
Switching capacity		A 600, P 600	

3RT, 3TB, 3TF Contactors for Switching Motors

3TF6 vacuum contactors, 3-pole, 335 ... 450 kW

Endurance of the auxiliary contacts

The contact endurance for utilization category AC-12 or AC-15/AC-14 depends mainly on the breaking current. It is assumed that the operating mechanisms are switched randomly, i. e. not synchronized with the phase angle of the supply system.

3TF68 and 3TF69 contactors at 230 V AC

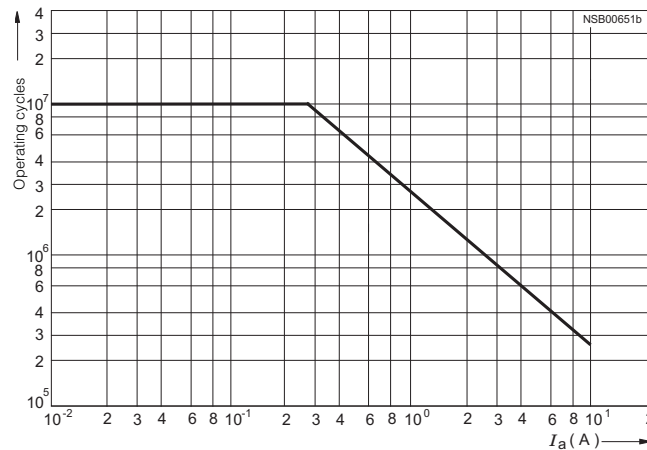

Contact erosion indication with 3TF68 and 3TF69 vacuum contactors

The contact erosion of the vacuum interrupters can be checked during operation with the help of 3 white double slides on the contactor base.

If the distance indicated by one of the double slides is < 0.5 mm while the contactor is in the closed position, the vacuum interrupter must be replaced. To ensure maximum reliability, it is recommended to replace all 3 vacuum interrupters.

Endurance of the main contacts

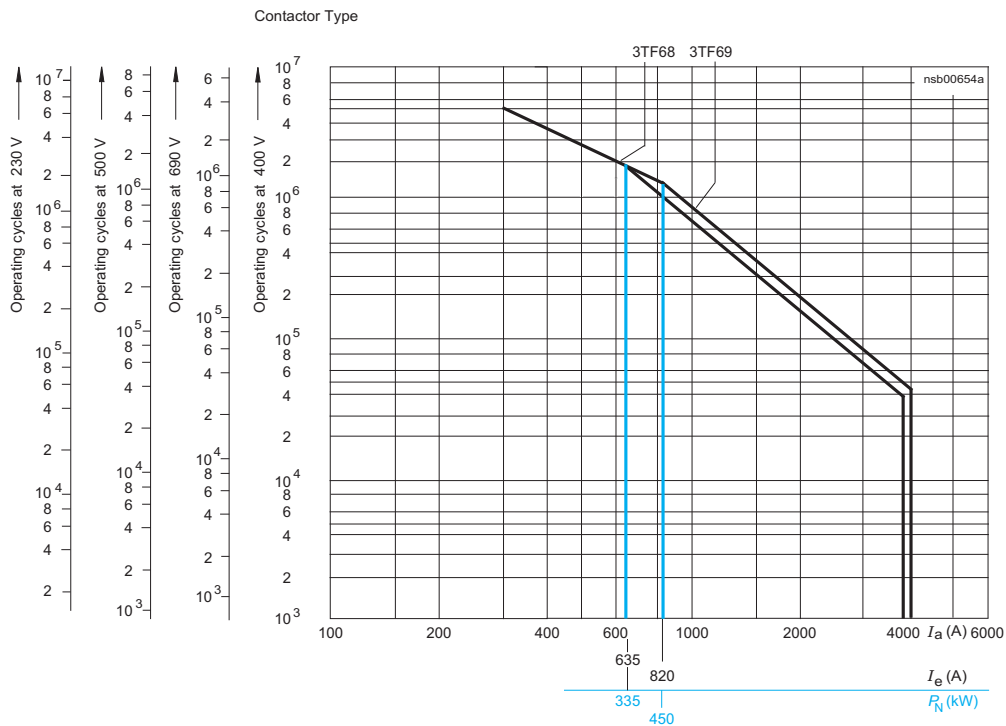

3TF68 and 3TF69 contactors

Diagram legend:

P_N = Rated power for squirrel-cage motors at 400 V

I_a = Breaking current

I_e = Rated operational current

3RT, 3TB, 3TF Contactors for Switching Motors

3TF6 vacuum contactors, 3-pole, 335 ... 450 kW

Contactors	Type Size	3TF68 14	3TF69 14
General data			
Permissible mounting position, installation instructions ^{1) 2)} The contactors are designed for operation on a vertical mounting surface.	AC operation and DC operation		
Mechanical endurance		Operating cycles	5 million
Electrical endurance		Operating cycles	³⁾
Rated insulation voltage U_i (degree of pollution 3)		kV	1
Rated impulse withstand voltage U_{imp}		kV	8
Protective separation between the coil and the main contacts acc. to EN 60947-1, Appendix N		kV	1
Mirror contacts A mirror contact is an auxiliary NC contact that cannot be closed simultaneously with a NO main contact. One NC contact each must be connected in series for the right and left auxiliary switch block respectively.		Yes, acc. to EN 60947-4-1, Appendix F	
Permissible ambient temperature	<ul style="list-style-type: none"> • During operation • During storage 	°C	-25 ... +55
		°C	-55 ... +80
Degree of protection acc. to EN 60947-1, Appendix C		IP00/open, coil assembly IP40	
Touch protection acc. to EN 50274		Finger-safe with cover	
Shock resistance			
• Rectangular pulse	- AC operation - DC operation	g/ms g/ms	8.1/5 and 4.7/10 9/5 and 5.7/10
• Sine pulse	- AC operation - DC operation	g/ms g/ms	12.8/5 and 7.4/10 14.4/5 and 9.1/10
			9.5/5 and 5.7/10 8.6/5 and 5.1/10 13.5/5 and 7.8/10 13.5/5 and 7.8/10
Conductor cross-sections		See "Conductor Cross-Sections".	
Electromagnetic compatibility (EMC)		See "Electromagnetic Compatibility (EMC)".	
Short-circuit protection			
Main circuit Fuse links, gL/gG LV HRC 3NA, DIAZED 5SB, NEOZED 5SE acc. to IEC 60947-4-1/ EN 60947-4-1	<ul style="list-style-type: none"> • Type of coordination "1" • Type of coordination "2" • Weld-free⁴⁾ 	A A A	1000 500 400
			1250 630 500
Auxiliary circuit			
• Fuse links gL/gG LV HRC 3NA, DIAZED 5SB, NEOZED 5SE (weld-free protection at $I_k \geq 1$ kA)		A	10
• Or miniature circuit breakers with C characteristic ($I_k < 400$ A)		A	10

¹⁾ To easily replace the laterally mounted auxiliary switches it is recommended to maintain a minimum distance of 30 mm between the contactors.

²⁾ If mounted at a 90° angle (conducting paths are horizontally above each other), the switching frequency is reduced by 80 % compared with the normal values.

³⁾ See "Endurance of the Auxiliary Contacts".

⁴⁾ Test conditions according to IEC 60947-4-1.

3RT, 3TB, 3TF Contactors for Switching Motors

3TF6 vacuum contactors, 3-pole, 335 ... 450 kW

Contactor	Type Size		3TF68 14	3TF69 14
Control				
Magnetic coil operating range			$0.8 \times U_{s \text{ min}} \dots 1.1 \times U_{s \text{ max}}$	
Power consumption of the magnetic coils (when coil is cold and $1.0 \times U_s$)				
• AC operation, $U_{s \text{ max}}$	- Closing - Closed	VA/p.f. VA/p.f.	1850/1 49/0.15	950/0.98 30.6/0.31
• AC operation, $U_{s \text{ min}}$	- Closing - Closed	VA/p.f. VA/p.f.	1200/1 13.5/0.47	600/0.98 12.9/0.43
• DC economy circuit ¹⁾	- Closing at 24 V - Closed	W W	1010 28	960 20.6
<u>For contactors of type 3TF68/69...-Q:</u>				
• AC operation, $U_{s \text{ min}}$ ²⁾	- Closing - Closed	VA/p.f. VA/p.f.	1000/0.99 11/1	1150/0.99 11/1
Operating times at $0.8 \dots 1.1 \times U_s$ (Total break time = Opening delay + Arcing time)			(Values apply to cold and warm coil)	
• AC operation	- Closing delay - Opening delay	ms ms	70 ... 120 (22 ... 65) ³⁾ 70 ... 100	80 ... 120 70 ... 80
• DC economy circuit	- Closing delay - Opening delay	ms ms	76 ... 110 50	86 ... 280 19 ... 25
• Arcing time		ms	10 ... 15	10
<u>For contactors of type 3TF68/69...-Q:</u>				
• AC operation	- Closing delay - Opening delay	ms ms	35 ... 90 65 ... 90	45 ... 160 30 ... 80
Operating times at $1.0 \times U_s$ (Total break time = Opening delay + Arcing time)				
• AC operation	- Closing delay - Opening delay	ms ms	80 ... 100 (30 ... 45) ³⁾ 70 ... 100	85 ... 100 70
• DC economy circuit	- Closing delay - Opening delay	ms ms	80 ... 90 50	90 ... 125 19 ... 25
Minimum command duration for closing	Standard Reduced make-time	ms ms	120 90	120 --
Minimum interval time between two ON commands		ms	100	300

1) At 24 V DC; for further voltages, deviations of up to $\pm 10\%$ are possible.

2) Including reversing contactor.

3) Values in brackets apply to contactors with reduced operating times.

3RT, 3TB, 3TF Contactors for Switching Motors

3TF6 vacuum contactors, 3-pole, 335 ... 450 kW

Contactors	Type Size		3TF68 14	3TF69 14
Main circuit				
<i>AC capacity</i>				
Utilization category AC-1 Switching resistive loads				
• Rated operational currents I_e	At 40 °C up to 690 V	A	700	910
	At 55 °C up to 690 V	A	630	850
	At 55 °C up to 1000 V	A	450	800
• Rated power for AC loads with p.f. = 0.95 at 55°C	230 V	kW	240	323
	400 V	kW	415	558
	500 V	kW	545	735
	690 V	kW	720	970
	1000 V	kW	780	1385
• Minimum conductor cross-sections for loads with I_e	At 40°C	mm ²	2 x 240	$I_e \geq 800$ A: 2 x 60 x 5 (copper busbars)
	At 55°C	mm ²	2 x 185	$I_e < 800$ A: 2 x 240
Utilization category AC-2 and AC-3				
• Rated operational currents I_e	Up to 690 V	A	630	820
	1000 V	A	435	580
• Rated power for slipping or squirrel-cage motors at 50 Hz and 60 Hz	At 230 V	kW	200	260
	400 V	kW	347	450
	500 V	kW	434	600
	690 V	kW	600	800
	1000 V	kW	600	800
Utilization category AC-4 (for $I_a = 6 \times I_e$)				
• Rated operational current I_e	Up to 690 V	A	610	690
• Rated power for squirrel-cage motors with 50 Hz and 60 Hz	At 400 V	kW	355	400
• The following applies to a contact endurance of about 200 000 operating cycles:				
- Rated operational currents I_e	Up to 690 V	A	300	360
	1000 V	A	210	250
- Rated power for squirrel-cage motors with 50 Hz and 60 Hz	At 230 V	kW	97	110
	400 V	kW	168	191
	500 V ¹⁾	kW	210	250
	690 V ¹⁾	kW	278	335
	1000 V ¹⁾	A	290	350
Utilization category AC-6a switching AC transformers				
• Rated operational currents I_e	Up to 400 V			
- For inrush current n = 20		A	513	675
- For inrush current n = 30		A	342	450
• Rating P				
- For inrush current n = 20	230 V	kVA	195	256
	400 V	kVA	338	445
	500 V	kVA	444	584
	690 V	kVA	586	771
	1000 V	kVA	752	1003
- For inrush current n = 30 ²⁾	230 V	kVA	130	171
	400 V	kVA	226	297
	500 V	kVA	296	389
	690 V	kVA	390	514
	1000 V	kVA	592	778
Utilization category AC-6b, switching low-inductance (low-loss, metallized dielectric) AC capacitors				
• Rated operational currents I_e	Up to 400 V	A	433	
• Rated power for single capacitors at 50 and 60 Hz	At 230 V	kvar	175	
	400 V	kvar	300	
	500 V	kvar	400	
	690 V	kvar	300	
• Rated power for banks of capacitors (mini- mum inductance is 6 µH between capacitors connected in parallel) at 50 and 60 Hz	At 230 V	kvar	145	
	400 V	kvar	250	
	500 V	kvar	333	
	690 V	kvar	250	

¹⁾ Max. permissible rated operational current $I_e/AC-4 = I_e/AC-3$ up to 500 V, for reduced contact endurance and reduced switching frequency.

²⁾ For deviating inrush current factors x, the power must be recalculated as follows:
 $P_x = P_{n30} \cdot 30/x$.

3RT, 3TB, 3TF Contactors for Switching Motors

3TF6 vacuum contactors, 3-pole, 335 ... 450 kW

Contactor	Type Size	3TF68 14	3TF69 14		
Main circuit					
AC capacity					
Short-time loading capacity (5 ... 30 s)					
• CLASS 5 and 10	A	630	820		
• CLASS 15	A	630	662		
• CLASS 20	A	536	572		
• CLASS 25	A	479	531		
• CLASS 30	A	441	500		
Thermal current-carrying capacity 10-s-current ¹⁾	A	5040	7000		
Power loss per conducting path at $I_e/AC-3/690\text{ V}$	W	45	70		
Switching frequency					
Switching frequency z in operating cycles/hour					
• Contactors without overload relays	No-load switching frequency AC	1/h	2000	1000	
	No-load switching frequency DC	1/h	1000	1000	
	AC-1	1/h	700	700	
	AC-2	1/h	200	200	
	AC-3	1/h	500	500	
	AC-4	1/h	150	150	
• Contactors with overload relays (mean value)		1/h	15	15	
Conductor cross-sections					
Main conductors:		Screw terminals			
• Busbar connections					
- Finely stranded with cable lug	mm ²	50 ... 240	50 ... 240		
- Stranded with cable lug	mm ²	70 ... 240	50 ... 240		
- Solid or stranded	AWG	2/0 ... 500 MCM	2/0 ... 500 MCM		
- Connecting bar (max. width)	mm	50	60 ($U_e \leq 690\text{ V}$) 50 ($U_e > 690\text{ V}$)		
• Terminal screw					
- Tightening torque	Nm	M10 x 30 14 ... 24 (124 ... 210 lb.in)	M12 x 40 20 ... 35 (177 ... 310 lb.in)		
• With box terminal ²⁾					
- Connectable copper bars					
- Width	mm	15 ... 25	15 ... 38		
- Max. thickness	mm	1 x 26 or 2 x 11	1 x 46 or 2 x 18		
- Terminal screw		A/F 6 (hexagon socket)	A/F 8 (hexagon socket)		
- Tightening torque	Nm	25 ... 40 (221 ... 354 lb.in)	35 ... 50 (266 ... 443 lb.in)		
Auxiliary conductors:					
• Solid	mm ²	2 x (0.5 ... 1) ³⁾ /2 x (1 ... 2.5) ³⁾			
• Finely stranded with end sleeve	mm ²	2 x (0.5 ... 1) ³⁾ /2 x (0.75 ... 2.5) ³⁾			
• Pin-end connector to DIN 46231	mm ²	2 x (1 ... 1.5)			
• Solid or stranded	AWG	2 x (18 ... 12)			
• Tightening torque	Nm	0.8 ... 1.4 (7 ... 12 lb.in)			
and ratings					
Rated insulation voltage		V AC	600	600	
Uninterrupted current		• Open and enclosed	A	630	820
Maximum horsepower ratings (and approved values)					
• Rated power for induction motors at 60 Hz	At 200 V	hp	231	290	
	230 V	hp	266	350	
	460 V	hp	530	700	
	575 V	hp	664	860	
NEMA/EEMAC ratings					
SIZE		hp	6	7	
• Uninterrupted current	- Open	A	600	820	
	- Enclosed	A	540	810	
• Rated power for induction motors at 60 Hz	At 200 V	hp	150	--	
	230 V	hp	200	300	
	460 V	hp	400	600	
	575 V	hp	400	600	
Overload relay		• Type • Setting range	A	3RB12 . 200 ... 820	

For short-circuit protection with overload relays see "Protection Equipment --> Overload Relays".

¹⁾ According to IEC 60947-4-1.

²⁾ See Accessories and Spare Parts.

³⁾ If two different conductor cross-sections are connected to one clamping point, both cross-sections must lie in the range specified. If identical cross-sections are used, this restriction does not apply.

3RT, 3TB, 3TF Contactors for Switching Motors

3TB5 contactors with DC solenoid system,
3-pole, 55 ... 200 kW

Overview

3TB5 contactors with DC solenoid system,
3-pole, 55 ... 200 kW

EN 60947-4-1.

The contactors are climate-proof and finger-safe according to EN 50274.

Technical specifications

Contactors	Type	3TB50	3TB52 to 3TB56
Rated data of the auxiliary contacts			
Acc. to IEC 60947-5-1 (VDE 0660 Part 200)			
Rated insulation voltage U_i (degree of pollution 3)	V	690	
Continuous thermal current I_{th} = Rated operational current $I_e/AC-12$	A	10	
AC load			
Rated operational current $I_e/AC-15/AC-14$			
• For rated operational voltage U_e			
	24 V A	10	
	110 V A	10	
	125 V A	10	
	220 V A	6	
	230 V A	5.6	
	380 V A	4	
	400 V A	3.6	
	500 V A	2.5	
	660 V A	2.5	
	690 V A	--	
DC load			
Rated operational current $I_e/DC-12$			
• For rated operational voltage U_e			
	24 V A	10	10
	60 V A	10	10
	110 V A	3.2	8
	125 V A	2.5	6
	220 V A	0.9	2
	440 V A	0.33	0.6
	600 V A	0.22	0.4
Rated operational current $I_e/DC-13^{1)}$			
• For rated operational voltage U_e			
	24 V A	10 (10)	10 (10)
	60 V A	5 (7)	5 (4)
	110 V A	1.14 (3.2)	2.4 (1.8)
	125 V A	0.98 (2.5)	2.1 (1.6)
	220 V A	0.48 (0.9)	1.1 (0.9)
	440 V A	0.13 (0.33)	0.32 (0.27)
	600 V A	0.075 (0.22)	0.21 (0.18)

Contactors	Type	3TB50 to 3TB56
Ⓢ and Ⓣ ratings of the auxiliary contacts		
Rated voltage	V AC, max.	600
Switching capacity		A 600, P 600

¹⁾ Values in brackets apply to auxiliary contacts with delayed NC contact.

3RT, 3TB, 3TF Contactors for Switching Motors

3TB5 contactors with DC solenoid system, 3-pole, 55 ... 200 kW

Endurance of the main contacts

The characteristic curves show the contact endurance of the contactors when switching resistive and inductive AC loads (AC-1/AC-3) depending on the breaking current and rated operational voltage. It is assumed that the operating mechanisms are switched randomly, i. e. not synchronized with the phase angle of the supply system.

The rated operational current I_e complies with utilization category AC-4 (breaking six times the rated operational current) and is intended for a contact endurance of approx. 200 000 operating cycles.

If a shorter endurance is sufficient, the rated operational current I_e /AC-4 can be increased.

If the contacts are used for mixed operation, i. e. normal switching (breaking the rated operational current according to utilization category AC-3) in combination with intermittent inching (breaking several times the rated operational current according to utilization category AC-4), the contact endurance can be calculated approximately from the following equation:

$$X = \frac{A}{1 + \frac{C}{100} \left(\frac{A}{B} - 1 \right)}$$

Characters in the equation:

- X Contact endurance for mixed operation in operating cycles
- A Contact endurance for normal operation ($I_a = I_e$) in operating cycles
- B Contact endurance for inching ($I_a = \text{multiple of } I_e$) in operating cycles
- C Inching operations as a percentage of total switching operations

3TB50 to 3TB56 contactors

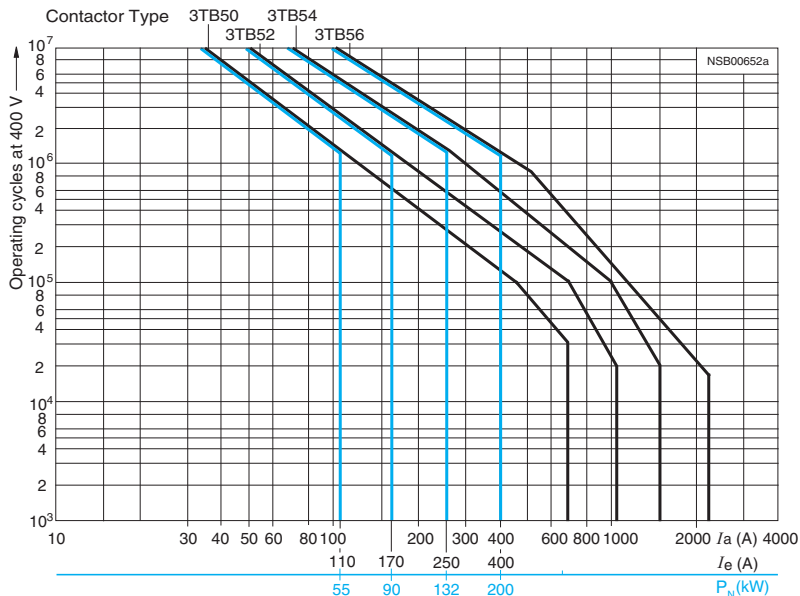

Diagram legend:

- P_N = Rated power for squirrel-cage motors at 400 V
- I_a = Breaking current
- I_e = Rated operational current

3

3RT, 3TB, 3TF Contactors for Switching Motors

3TB5 contactors with DC solenoid system,
3-pole, 55 ... 200 kW

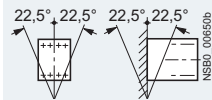
Contactors	Type Size	3TB50 6	3TB52 8	3TB54 10	3TB56 12		
General data							
Permissible mounting position Installation instructions ¹⁾ The contactors are designed for operation on a vertical mounting surface.							
Mechanical endurance		Operating cycles	10 million				
Electrical endurance			2)				
Rated insulation voltage U_i		V	1000				
Protective separation between the coil and the main contacts acc. to EN 60947-1, Appendix N		V	690				
Mirror contacts A mirror contact is an auxiliary NC contact that cannot be closed simultaneously with a NO main contact.			Yes, acc. to EN 60947-4-1, Appendix F				
Permissible ambient temperature		°C	-25 ... +55				
		°C	-50 ... +80				
Degree of protection acc. to EN 60947-1, Appendix C			IP00 (open), coil assembly IP40				
Touch protection acc. to EN 50274			Finger-safe with cover				
Shock resistance (rectangular pulse)		g/ms	5/10	5.9/10	5.9/10	5.9/10	
Short-circuit protection							
Main circuit							
Fuse links gL/gG		• Type of coordination *1*	A	250	315	400	630
LV HRC 3NA, DIAZED 5SB		• Type of coordination *2*	A	224	250	315	500
Auxiliary circuit short-circuit current $I_k \geq 1$ kA							
• Fuse links gL/gG, DIAZED 5SB, NEOZED 5SE		A	16				
• Miniature circuit breaker with C characteristic		A	10				
Control							
Magnetic coil operating range			0.8 ... 1.1 x U_s				
Power consumption of the magnetic coil (for cold coil and 1.0 x U_s) Closing = Closed		W	25	30	60	86	
Operating times at 0.8 ... 1.1 x U_s Total break time = Opening delay + Arcing time			(The values apply up to and including 20 % undervoltage, 10 % overvoltage, as well as when the coil is cold and warm)				
• Closing delay		ms	105 ... 360	115 ... 400	105 ... 400	110 ... 400	
• Opening delay ³⁾		ms	18 ... 30	22 ... 35	24 ... 55	40 ... 110	
• Arcing time		ms	10 ... 15	10 ... 15	10 ... 15	10 ... 15	
Operating times at 1.0 x U_s							
• Closing delay		ms	120 ... 230	130 ... 250	115 ... 250	120 ... 250	
• Opening delay ³⁾		ms	20 ... 26	24 ... 32	35 ... 50	60 ... 95	
Main circuit							
AC capacity							
Utilization category AC-1, switching resistive loads							
• Rated operational current I_e		At 40 °C up to 690 V A	170	230	325	425	
		At 55 °C up to 690 V A	160	200	300	400	
• Rated power for AC loads ⁴⁾ P.f. = 0.95 (at 55 °C)		230 V kW	61	76	114	152	
		400 V kW	105	132	195	262	
		500 V kW	138	173	260	345	
		690 V kW	183	228	340	455	
• Minimum conductor cross-sections for loads with I_e		mm ²	70	95	185	240	
Utilization category AC-2 and AC-3							
5)							
Utilization category AC-4 (for $I_a = 6 \times I_e$)							
• The following applies to a contact endurance of about 200 000 operating cycles:							
- Rated operational current I_e		A	52	72	103	120	
- Rated power for squirrel-cage motors with 50 Hz and 60 Hz		230 V kW	15.6	21	31	37.5	
		400 V kW	27	37	55	65	
		500 V kW	35	48	72	85.5	
		690 V kW	45	64	92	106	
- Max. rated operational current I_e /AC-4		At 400 V A	110	170	250	400	

1) For reversing duty, deviations from the vertical axis are not permitted.

2) See "Endurance of the Main Contacts".

3) The opening delay times can increase if the contactor coils are damped against voltage peaks.

4) Industrial furnaces and electric heaters with resistance heating, etc. (increased power consumption on heating up has been taken into account).

5) See selection table in Catalog LV 1.

3RT, 3TB, 3TF Contactors for Switching Motors

3TB5 contactors with DC solenoid system, 3-pole, 55 ... 200 kW

Contactors	Type Size		3TB50 6	3TB52 8	3TB54 10	3TB56 12
Main circuit						
AC capacity						
Switching low-inductance (low-loss, metallized dielectric) AC capacitors¹⁾						
• Rated operational current I_{θ} at 400 V		A	87	144	217	289
• Rated power for single capacitors at 50 Hz	230 V	kvar	35	58	87	115
	400 V	kvar	60	100	150	200
	500 V	kvar	80	130	190	265
	690 V	kvar	60	100	150	200
• Rated power for banks of capacitors (minimum inductance is 6 μ H between capacitors connected in parallel) at 50 Hz	230 V	kvar	30	40	66	85
	400 V	kvar	50	70	115	150
	500 V	kvar	66	90	145	195
	690 V	kvar	50	70	115	150
Load rating with DC						
Utilization category DC-1						
Switching resistive loads ($L/R \leq 1$ ms)						
• Rated operational current I_{θ} (at 55 °C)						
- 1 conducting path	24 V	A	160	200	300	400
	60 V	A	80	80	300	330
	110 V	A	18	18	33	33
	220 V	A	3.4	3.4	3.8	3.8
	440 V	A	0.8	0.8	0.9	0.9
	600 V	A	0.5	0.5	0.6	0.6
- 2 conducting paths in series	24 V	A	160	200	300	400
	60 V	A	160	200	300	400
	110 V	A	160	200	300	400
	220 V	A	20	20	300	400
	440 V	A	3.2	3.2	4	4
	600 V	A	1.6	1.6	2	2
- 3 conducting paths in series	24 V	A	160	200	300	400
	60 V	A	160	200	300	400
	110 V	A	160	200	300	400
	220 V	A	160	200	300	400
	440 V	A	11.5	11.5	11	11
	600 V	A	4	4	5.2	5.2
Utilization category DC-3/DC-5						
Shunt-wound and series-wound motors ($L/R \leq 15$ ms)						
• Rated operational current I_{θ} (at 55 °C)						
- 1 conducting path	24 V	A	16	16	35	35
	60 V	A	7.5	7.5	11	11
	110 V	A	2.5	2.5	3	3
	220 V	A	0.6	0.6	0.6	0.6
	440 V	A	0.17	0.17	0.18	0.18
	600 V	A	0.12	0.12	0.125	0.125
- 2 conducting paths in series	24 V	A	160	200	300	400
	60 V	A	160	200	300	400
	110 V	A	160	200	300	400
	220 V	A	2.5	2.5	2.5	2.5
	440 V	A	0.65	0.65	0.65	0.65
	600 V	A	0.37	0.37	0.37	0.37
- 3 conducting paths in series	24 V	A	160	200	300	400
	60 V	A	160	200	300	400
	110 V	A	160	200	300	400
	220 V	A	160	200	300	400
	440 V	A	1.4	1.4	1.4	1.4
	600 V	A	0.75	0.75	0.75	0.75
Switching frequency						
Switching frequency z in operating cycles/hour						
• Contactors without overload relays	AC-1	h ⁻¹	1000			
	AC-2	h ⁻¹	500			
	AC-3	h ⁻¹	500			
	AC-4	h ⁻¹	250			
• Contactors with overload relays (mean value)		h ⁻¹	15			

¹⁾ Contact endurance 0.1 million operating cycles.

3RT, 3TB, 3TF Contactors for Switching Motors

3TB5 contactors with DC solenoid system, 3-pole, 55 ... 200 kW

Contactor	Type Size		3TB50 6	3TB52 8	3TB54 10	3TB56 12
Conductor cross-sections						
Main conductors:			⊕ Screw terminals			
• Finely stranded with cable lug	mm ²		16 ... 70	35 ... 95	50 ... 240	50 ... 240
• Stranded with cable lug	mm ²		25 ... 70	50 ... 120	70 ... 240	70 ... 240
• Busbars	mm		15 x 3	20 x 3	25 x 5	2 x (25 x 3)
• Terminal screw			M6	M8	M10	M10
Auxiliary conductors:						
• Solid	mm ²		1 ... 2.5			
• Finely stranded with end sleeve	mm ²		0.75 ... 1.5			
• Pin-end connector (DIN 46231)	mm ²		2 x 1 ... 2.5			
Protective conductors:						
Stranded with cable lug	mm ²		--	25 ... 70	35 ... 70	50 ... 120
Ⓢ and Ⓣ ratings						
Ⓢ rating						
• Uninterrupted current	- Open	A	150	170	240	300
	- Enclosed	A	135	153	215	270
• Rated power for induction motors at 60 Hz (enclosed)	115 V	hp	25	30	40	50
	230 V	hp	50	60	75	100
	460 V	hp	100	120	150	200
	575 V	hp	125	160	200	250
• Overload relay	- Type		3RB20 56	3RB20 56	3RB20 66	3RB20 66
	- Setting range	A	50 ... 200	50 ... 200	50 ... 250	200 ... 540
• NEMA/EEMAC size	- Contactors		4	4	4	5
	- Starters (= contactors + overload relay, enclosed)		3	4	4	5
Ⓣ rating						
• Uninterrupted current	- Open	A	150	150	240	390
	- Enclosed	A	135	135	215	350
• Rated power for induction motors at 60 Hz	115 V	hp	25	25	30	--
	230 V	hp	50	50	75	125
	460 V	hp	100	100	150	250
	575 V	hp	125	125	200	300 ¹⁾
• Overload relay	- Type		3RB20 56	3RB20 56	3RB20 66	3RB20 66
	- Setting range	A	50 ... 200	50 ... 200	50 ... 250	200 ... 540
• NEMA/EEMAC size	- Contactors		4	4	4	5
	- Starters (= contactors + overload relay, enclosed)		3	4	4	5
Short-circuit protection devices						
• CLASS RK5 fuses		A	400	400	450	600
• Circuit breakers acc. to UL 489		A	175	175	250	600

¹⁾ At 575/600 V AC max.
rated motor current 325 A and
motor starting current 3250 A.

3RT, 3TB, 3TF Contactors for Switching Motors

3TF2 contactors, 3-pole, 2.2 ... 4 kW

Overview

AC and DC operation

IEC 60947 (VDE 0660).

The contactors are suitable for use in any climate. The contactors with screw terminals are finger-safe according to EN 50274.

The contactors are available in versions with screw terminals, 6.3 mm plug-in terminals and solder pin connections for soldering in printed circuit boards.

Design

Auxiliary contacts

Contact reliability

To switch voltages ≤ 110 V and currents ≤ 100 mA the 3TF2 contactor relays should be used as they guarantee a high level of contact reliability.

These auxiliary contacts are suitable for solid-state circuits with currents ≥ 1 mA at a voltage of 17 V and higher.

Short-circuit protection of the contactors

For short-circuit protection of the contactors without overload relays see "Technical specifications".

Version

The 3TF2 contactors are available with SIGUT screw terminals, 6.3 mm x 0.8 mm flat connectors and solder pin connectors.

The contactors with 6.3 mm x 0.8 mm flat connectors can be used in the plug-in base with solder pin connectors for printed circuit boards. The contactors are coded and the plug-in base is codable in order to ensure non-interchangeability.

Auxiliary switch blocks

The contactors with 1 auxiliary contact with screw terminals can be expanded by up to four contacts by the addition of snap-on auxiliary switch blocks.

The contactors according to EN 50012 with identification number 10E can be expanded into contactors with 2, 4 and 5 auxiliary contacts according to EN 50012 using auxiliary switch blocks.

The identification numbers 11E, 22E, 23E and 32E on the auxiliary switch blocks apply to the complete contactors (see the graphic on the right). These auxiliary switch blocks cannot be combined with contactors with identification number 01E.

All contactors with screw terminals and 1 auxiliary contact according to EN 50012, identification number 10E and 01E, can be extended with auxiliary switch blocks 40, 31, 22, 20, 11 and 02 to obtain contactors with 3 or 5 auxiliary contacts according to EN 50005. The identification numbers on the auxiliary switch blocks apply only to the attached auxiliary switches.

3TF20-0 motor contactors according to EN 50012 or EN 50005

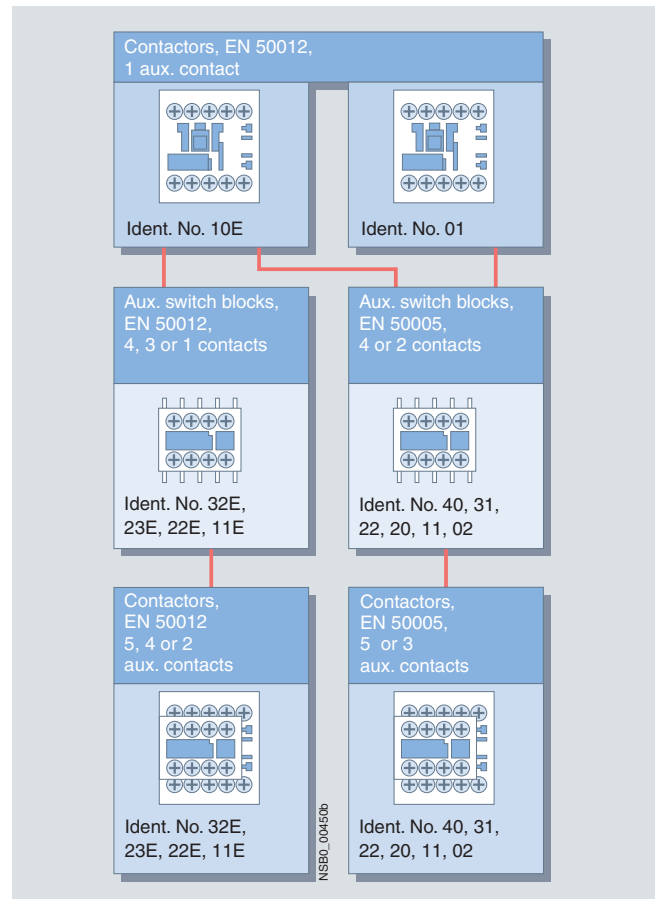

Surge suppression

RC elements, varistors, diodes or diode assemblies (combination of a diode and a Zener diode for short break times) can be plugged onto all 3TF2 contactors and auxiliary switch blocks with screw terminals from the front in order to damp opening surges in the coil. The unit labeling plate must be removed for this purpose. It can be snapped onto the attached surge suppressor.

Note:

The OFF-delay of the NO contacts and the ON-delay of the NC contacts increase if the contactor coils are protected against voltage peaks (noise suppression diode 6 to 10 times, diode assemblies 2 to 6 times, varistor +2 to 5 ms).

Reversing duty

To use the 3TF2 AC-operated contactor in reversing or Dahlander mode an additional dead interval of 50 ms is required along with an NC contact interlock.

3RT, 3TB, 3TF Contactors for Switching Motors

3TF2 contactors, 3-pole, 2.2 ... 4 kW

Technical specifications

Contactors Type **3TF2**

Endurance of the auxiliary contacts

The contact endurance for utilization category AC-12 or AC-15/AC-14 depends mainly on the breaking current. It is assumed that the operating mechanisms are switched randomly, i. e. not synchronized with the phase angle of the supply system. Diagram legend:

I_a = Breaking current
 I_e = Rated operational current

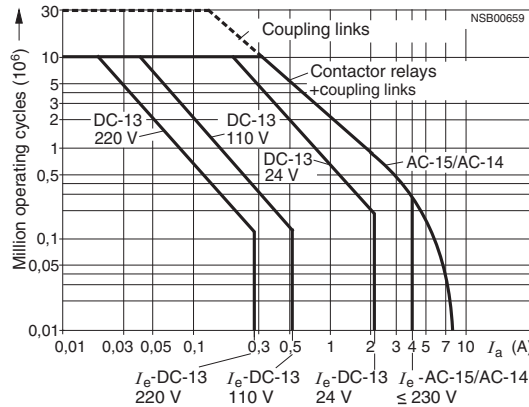

3TF2

Endurance of the main contacts

The characteristic curves show the contact endurance of the contactors when switching inductive AC loads (AC-3) depending on the breaking current and rated operational voltage. It is assumed that the operating mechanisms are switched randomly, i. e. not synchronized with the phase angle of the supply system.

The rated operational current I_e complies with utilization category AC-4 (breaking six times the rated operational current) and is intended for a contact endurance of at least 200 000 operating cycles. If a shorter endurance is sufficient, the rated operational current $I_e/AC-4$ can be increased.

If the contacts are used for mixed operation, i. e. normal switching (breaking the rated operational current according to utilization category AC-3) in combination with intermittent inching (breaking several times the rated operational current according to utilization category AC-4), the contact endurance can be calculated approximately from the following equation:

$$X = \frac{A}{1 + \frac{C}{100} \left(\frac{A}{B} - 1 \right)}$$

Characters in the equation:

X = Contact endurance for mixed operation in operating cycles

A = Contact endurance for normal operation ($I_a = I_e$) in operating cycles

B = Contact endurance for inching

(I_a = multiple of I_e) in operating cycles

C = Inching operations as a percentage of total switching operations

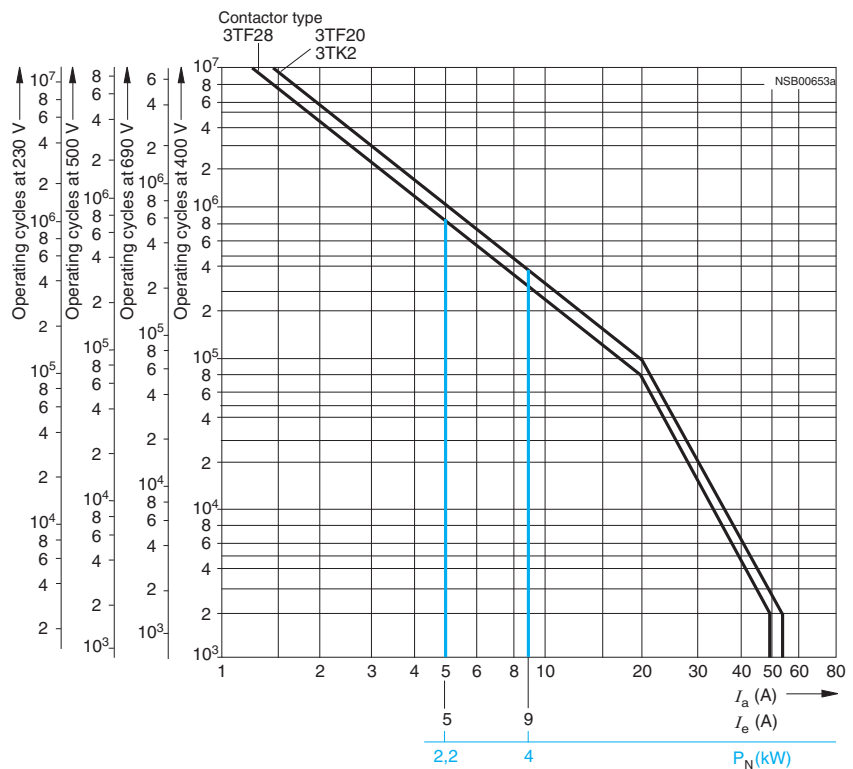

Diagram legend:

P_N = Rated power for squirrel-cage motors at 400 V

I_a = Breaking current

I_e = Rated operational current

3RT, 3TB, 3TF Contactors for Switching Motors

3TF2 contactors, 3-pole, 2.2 ... 4 kW

Contactors	Type		3TF20/3TF28	3TF22/3TF29
General data				
Permissible mounting position	AC and DC operation		Any	
Mechanical endurance	<ul style="list-style-type: none"> AC operation DC operation Auxiliary switch block 	Operating cycles	10 million 30 million 10 million	
Rated insulation voltage U_i (degree of pollution 3)				
	• Screw terminals	V	690	690 ¹⁾
	• Flat connector 6.3 mm x 0.8 mm	V	500	--
	• Solder pin connections	V	500	--
Rated impulse withstand voltage U_{imp} (degree of pollution 3)				
	• Screw terminals	kV	8	8 ²⁾
	• Flat connector 6.3 mm x 0.8 mm	kV	6	--
	• Solder pin connections	kV	6	--
Protective separation between coil and main contacts (acc. to EN 61140)		V	Up to 300	
Mirror contacts A mirror contact is an auxiliary NC contact that cannot be closed simultaneously with a NO main contact.			Yes, this applies to both the basic unit as well as to between the basic unit and the mounted auxiliary switch block acc. to EN 60947-4-1, Appendix F	Yes, acc. to EN 60947-4-1 Appendix F SUVA
Permissible ambient temperature ³⁾	<ul style="list-style-type: none"> During operation During storage 	°C	-25 ... +55 -55 ... +80	
Degree of protection acc. to EN 60947-1 Appendix C			IP00 open IP20 for screw terminals IP40 coil assembly	
Touch protection acc. to EN 50274			Finger-safe for screw terminals	
Shock resistance				
• Without 3TX44 auxiliary switch block				
- Rectangular pulse	- AC operation	g/ms	8.3/5 and 5.2/10	--
	- DC operation	g/ms	11.3/5 and 9.2/10	--
- Sine pulse	- AC operation	g/ms	13/5 and 8/10	--
	- DC operation	g/ms	17.4/5 and 12.9/10	--
• With 3TX44 auxiliary switch block				
- Rectangular pulse	- AC operation	g/ms	5/5 and 3.6/10	5/5 and 3.6/10
	- DC operation	g/ms	9/5 and 6.9/10	9/5 and 7.3/10
- Sine pulse	- AC operation	g/ms	7.8/5 and 5.6/10	7.8/5 and 5.6/10
	- DC operation	g/ms	13.9/5 and 10.1/10	14/5 and 11/10
Conductor cross-sections 4)				
Short-circuit protection for contactors without overload relays				
Main circuit ⁵⁾				
• Fuse links gL/gG LV HRC 3NA, DIAZED 5SB, NEOZED 5SE acc. to IEC 60947-4-1 (VDE 0660, Part 102)				
	- Type of coordination "1"	A	25	
	- Type of coordination "2" ⁶⁾	A	10	
	- Weld-free	A	10	
• Miniature circuit breaker with C characteristic				
		A	10	
Auxiliary circuit Short-circuit current $I_k \geq 1$ kA				
• Fuse links gL/gG DIAZED 5SB, NEOZED 5SE				
		A	6	

1) Auxiliary contacts 500 V.

2) Auxiliary contacts 6 kV.

3) Applies to 50/60 Hz coil:
At 50 Hz, $1.1 \times U_n$, side-by-side mounting and 100 % ON period the max. ambient temperature is +40 °C.

4) See "Conductor Cross-Sections".

5) According to excerpt from IEC 60947-4-1 (VDE 0660 Part 102)

Type of coordination "1":

Destruction of the contactor and the overload relay is permissible. The contactor and/or overload relay can be replaced if necessary.

Type of coordination "2":

The overload relay must not suffer any damage. Contact welding on the contactor is permissible, however, if the contacts can be easily separated.

6) A short-circuit current of $I_q \leq 6$ kA applies to type of coordination "2".

3RT, 3TB, 3TF Contactors for Switching Motors

3TF2 contactors, 3-pole, 2.2 ... 4 kW

Contactors	Type	3TF2	
Control			
Magnetic coil operating range¹⁾		0.8 ... 1.1 x U_s	
Power consumption of the magnetic coils (when coil is cold and 1.0 x U_s)			
Standard version:			
• AC operation, 50 Hz	Closing	VA	15
	P.f.		0.41
	Closed	VA	6.8
	P.f.		0.42
• AC operation, 60 Hz	Closing	VA	14.4
	P.f.		0.36
	Closed	VA	6.1
	P.f.		0.46
• AC operation, 50/60 Hz ¹⁾	Closing	VA	16.5/13.2
	P.f.		0.43/0.38
	Closed	VA	8.0/5.4
	P.f.		0.48/0.42
For USA and Canada:			
• AC operation, 50 Hz	Closing	VA	14.6
	P.f.		0.38
	Closed	VA	6.5
	P.f.		0.40
• AC operation, 60 Hz	Closing	VA	14.4
	P.f.		0.30
	Closed	VA	6.0
	P.f.		0.44
• DC operation	Closing = Closed	W	3
Permissible residual current of the electronic circuit²⁾ (for 0 signal)			
	• AC operation	mA	$\leq 3 \times (230 \text{ V}/U_s)$
	• DC operation	mA	$\leq 1 \times (230 \text{ V}/U_s)$
Operating times at 0.8 ... 1.1 x U_s³⁾			
Total break time = Opening delay + Arcing time			
Values apply with coil in cold state and at operating temperature for operating range			
• AC operation	Closing delay	ms	5 ... 19
	Opening delay	ms	2 ... 22
- Dead interval			To use the 3TF2 AC-operated contactor in reversing an additional dead interval of 50 ms is required along with an NC contact interlock.
• DC operation	Closing delay	ms	16 ... 65
	Opening delay	ms	2 ... 5
• Arcing time		ms	10 ... 15
Operating times at 1.0 x U_s³⁾			
• AC operation	Closing delay	ms	5 ... 18
	Opening delay	ms	3 ... 21
- Dead interval			To use the 3TF2 AC-operated contactor in reversing an additional dead interval of 50 ms is required along with an NC contact interlock.
• DC operation	Closing delay	ms	19 ... 31
	Opening delay	ms	3 ... 4
• Arcing time		ms	10 ... 15

¹⁾ Applies to 50/60 Hz coil:
At 50 Hz, 1.1 x U_s , side-by-side mounting and 100 % ON period the max. ambient temperature is +40 °C.

²⁾ The 3TX4 490-1J additional load module is recommended for higher residual currents (see "Accessories and Spare Parts").

³⁾ The OFF-delay of the NO contact and the ON-delay of the NC contact are increased if the contactor coils are attenuated against voltage peaks (noise suppression diode 6 to 10 times; diode assemblies 2 to 6 times, varistor +2 to 5 ms).

3RT, 3TB, 3TF Contactors for Switching Motors

3TF2 contactors, 3-pole, 2.2 ... 4 kW

Contactor	Type		3TF28 3TF29	3TF20 ...-0..., 3TF22 ...-0...	3TF20 ...-3..., 3TF20 ...-6..., 3TF20 ...-7... S00	
	Size		S00	S00	S00	
Main circuit						
<i>AC capacity</i>						
Utilization category AC-1						
Switching resistive loads						
• Rated operational current I_e (at 40 °C)	Up to 400/380 V	A	18	18	18	
	690/660 V	A	18	18	--	
• Rated operational current I_e (at 55 °C)	400/380 V	A	16	16	16	
	690/660 V	A	16	16	--	
• Rated power of AC loads P.f. = 1	At 230/220 V	kW	6.0	6.0	6.0	
	400/380 V	kW	10	10	10	
	500 V	kW	13	13	13	
	690/660 V	kW	17	17	--	
• Minimum conductor cross-section for loads with I_e		mm ²	2.5	2.5	2.5	
Utilization category AC-2 and AC-3						
• Rated operational current I_e	Up to 220 V	A	5.1	9.0	9.0	
	230 V	A	5.1	9.0	9.0	
	380 V	A	5.1	9.0	9.0	
	400 V	A	5.1	8.4	8.4	
	500 V	A	4.8	6.5	6.5	
	660 V	A	4.8	5.2	--	
	690 V	A	4.8	5.2	--	
	• Rated power for motors with slipping or squirrel cage at 50 and 60 Hz and	At 110 V	kW	0.7	1.2	1.2
		115 V	kW	0.7	1.2	1.2
120 V		kW	0.7	1.3	1.3	
127 V		kW	0.8	1.4	1.4	
200 V		kW	1.2	2.2	2.2	
220 V		kW	1.3	2.4	2.4	
230 V		kW	1.4	2.5	2.5	
240 V		kW	1.5	2.6	2.6	
380 V		kW	2.2	4.0	4.0	
400 V		kW	2.2	4.0	4.0	
415 V		kW	2.5	4.0	4.0	
440 V		kW	2.5	4.0	4.0	
• Max. permissible rated operational current $I_g/AC-4 \cong I_e/AC-3$ up to 500 V, for reduced contact endurance and reduced switching frequency	460 V	kW	2.7	4.0	4.0	
	500 V	kW	2.9	4.0	4.0	
	575 V	kW	3.2	4.0	--	
	660 V	kW	3.8	4.0	--	
	690 V	kW	4.0	4.0	--	
	Utilization category AC-4					
	(contact endurance approx. 200 000 operating cycles at $I_a = 6 \times I_e$)					
• Rated operational current I_e	Up to 400 V	A	1.9	2.6	2.6	
	690 V	A	1.4	1.8	--	
• Rated power for motors with squirrel cage at 50 and 60 Hz and	At 110 V	kW	0.23	0.32	0.32	
	115 V	kW	0.24	0.33	0.33	
	120 V	kW	0.26	0.35	0.35	
• Max. permissible rated operational current $I_g/AC-4 \cong I_e/AC-3$ up to 500 V, for reduced contact endurance and reduced switching frequency	127 V	kW	0.27	0.37	0.37	
	200 V	kW	0.42	0.58	0.58	
	220 V	kW	0.47	0.64	0.64	
	230 V	kW	0.49	0.67	0.67	
	240 V	kW	0.51	0.70	0.70	
	380 V	kW	0.81	1.10	1.10	
	400 V	kW	0.85	1.15	1.15	
	415 V	kW	0.93	1.20	1.20	
	440 V	kW	1.0	1.27	1.27	
	460 V	kW	1.0	1.33	1.33	
	500 V	kW	1.1	1.45	1.45	
	575 V	kW	1.0	1.30	--	
660 V	kW	0.86	1.10	--		
690 V	kW	0.89	1.15	--		



3RT, 3TB, 3TF Contactors for Switching Motors

3TF2 contactors, 3-pole, 2.2 ... 4 kW

Contactors	Type	3TF28 3TF29			3TF20 ..-0... 3TF22 ..-0...			3TF20 ..-3... 3TF20 ..-6... 3TF20 ..-7...		
		S00			S00			S00		
Main circuit										
AC capacity										
Utilization category AC-5a										
Switching gas discharge lamps										
Per main current path at 230/220 V										
• Rated power per lamp	Rated operational current per lamp (A)									
- Uncorrected										
L 18 W	0.37	Units		43						
L 36 W	0.43	Units		37						
L 58 W	0.67	Units		23						
- DUO switching										
L 18 W	0.11	Units		144						
L 36 W	0.21	Units		76						
L 58 W	0.32	Units		50						
Switching gas discharge lamps with correction, solid-state ballast										
Per main current path at 230/220 V										
• Rated power per lamp	Capacitance (µF)	Rated operational current per lamp (A)								
- Parallel correction										
L 18 W	4.5	0.11	Units	22						
L 36 W	4.5	0.21	Units	22						
L 58 W	7	0.31	Units	14						
- With solid-state ballast (single lamp)										
L 18 W	6.8	0.10	Units	63						
L 36 W	6.8	0.18	Units	35						
L 58 W	10	0.27	Units	23						
- With solid-state ballast (two lamps)										
L 18 W	10	0.18	Units	35						
L 36 W	10	0.35	Units	18						
L 58 W	22	0.52	Units	12						
Utilization category AC-5b, switching incandescent lamps				kW	1.6				--	
Per main current path at 230/220 V										
Utilization category AC-6a, switching AC transformers										
• Rated operational current I_e										
- For inrush current n = 20		At 400 V	A	2.9		5.1		5.1		
- For inrush current n = 30		At 400 V	A	1.9		3.3		3.3		
• Rated power P										
- For inrush current n = 20		Up to 230/220 V	kVA	1.14		2.0		2.0		
		400/380 V	kVA	2		3.5		3.5		
		500 V	kVA	4.1		4.6		4.6		
		690/660 V	kVA	5.4		6.0		--		
- For inrush current n = 30		Up to 230/220 V	kVA	0.74		1.3		1.3		
		400/380 V	kVA	1.3		2.3		2.3		
		500 V	kVA	2.8		3.1		3.1		
		690/660 V	kVA	3.6		4.0		--		
For deviating inrush current factors x, the power must be recalculated as follows: $P_x = P_{n30} \times (30/x)$										
Utilization category AC-6b				No switching capacity						
Switching low-inductance (low-loss, metallized dielectric) AC capacitors										
Utilization category AC-7a										
Switching low inductive loads in household appliances										
• Rated operational current I_e (at 55 °C)		At 400/380 V	A	16		16		16		
		690/660 V	A	16		16		--		
• Rated power at 50 and 60 Hz		At 230/220 V	kW	6		6		6		
		400/380 V	kW	10		10		10		
• Minimum conductor cross-section for loads with I_e			mm ²	2.5		2.5		2.5		
Utilization category AC-7b										
Switching motor loads in household appliances										
• Rated operational current I_e		Up to 220 V	A	5.1		9.0		9.0		
		230 V	A	5.1		9.0		9.0		
		380 V	A	5.1		9.0		9.0		
		400 V	A	5.1		8.4		8.4		
• Rated power of motors at 50 and 60 Hz and		At 110 V	kW	0.68		1.2		1.2		
		220 V	kW	1.3		2.4		2.4		
		230 V	kW	1.4		2.5		2.5		
		240 V	kW	1.5		2.6		2.6		
		380 V	kW	2.2		4.0		4.0		
		400 V	kW	2.4		4.0		4.0		

3RT, 3TB, 3TF Contactors for Switching Motors

3TF2 contactors, 3-pole, 2.2 ... 4 kW

Contactor	Type	3TF28 3TF29	3TF20 ...-0..., 3TF22 ...-0...	3TF20 ...-3..., 3TF20 ...-6..., 3TF20 ...-7...
	Size	S00	S00	S00
Main circuit				
<i>Load rating with DC</i>				
Utilization category DC-1				
Switching resistive loads				
(contact endurance 0.1×10^6 operating cycles; $L/R \leq 1$ ms)				
• Rated operational current I_{θ} (at 55 °C)				
- 1 conducting path	Up to 24 V A 60 V A 110 V A 220/240 V A	10 4 1.5 0.6	16 6 2 1	16 6 2 1
- 2 conducting paths in series	Up to 24 V A 60 V A 110 V A 220/240 V A	10 10 4 1.5	16 16 6 2	16 16 6 2
- 3 conducting paths in series	Up to 24 V A 60 V A 110 V A 220/240 V A	10 10 10 4	16 16 16 6	16 16 16 6
Utilization category DC-3 and DC-5				
Shunt-wound and series-wound motors ($L/R \leq 15$ ms)				
• Rated operational current I_{θ} (at 55 °C)				
- 1 conducting path	Up to 24 V A 60 V A 110 V A 220/240 V A	4 1.8 0.3 --	6 3 0.5 0.1	6 3 0.5 0.1
- 2 conducting paths in series	Up to 24 V A 60 V A 110 V A 220/240 V A	6 3 1.5 0.3	10 5 2 0.5	10 5 2 0.5
- 3 conducting paths in series	Up to 24 V A 60 V A 110 V A 220/240 V A	10 10 10 1.5	16 16 16 2	16 16 16 2
Thermal load capacity	10 s current A	70		
Power loss per conducting path	At $I_{\theta}/AC-3$ W	0.3		
<i>Switching frequency</i>				
Switching frequency z in operating cycles/hour				
• Contactors without overload relays	No-load switching frequency	h ⁻¹	10000	
Dependence of the switching frequency z' on the operational current I' and operational voltage U':	AC-1	h ⁻¹	1000	
$z' = z \cdot (I_{\theta}/I') \cdot (400 V/U')^{1.5} \cdot 1/h$	AC-2	h ⁻¹	500	
	AC-3	h ⁻¹	1000	
• Contactors with overload relays (mean value)		h ⁻¹	15	
Conductor cross-sections				
Main and auxiliary conductors				
• Solid		mm ²	 Screw terminals 2 x (0.5 ... 2.5), 1 x 4 2 x (20 ... 14) AWG, 1 x 12 AWG	
• Finely stranded with end sleeve		mm ²	2 x (0.5 ... 1.5), 1 x 2.5	
• Pin-end connector (DIN 46231)		mm ²	1 x 1 ... 2.5	
• Terminal screw			M3	
• Prescribed tightening torque for terminal screws		Nm	0.8 ... 1.3 (7 ... 11lb.in)	
• When using a plug-in sleeve	6.3 ... 1	mm ²	 Flat connectors 0.5 ... 1	
• Finely stranded	6.3 ... 2.5	mm ²	1 ... 2.5	
 Solder pin connections (only for printed circuit boards)				

3RT, 3TB, 3TF Contactors for Switching Motors

3TF2 contactors, 3-pole, 2.2 ... 4 kW

Contactor	Type	3TF20 ...-0...	3TF20 ...-3..., 3TF20 ...-6..., 3TF20 ...-7... S00
	Size	S00	S00
Ⓢ and Ⓣ rated data of the 3TF20 contactors			
Rated insulation voltage U_i	V AC	600	300
Uninterrupted current	• Open and enclosed A	16	16 (10 for solder pin connection)
Maximum horsepower ratings (Ⓢ and Ⓣ approved values)			
• Rated power for induction motors at 60 Hz			
- 1-phase	At 115 V hp	0.5	--
	200 V hp	1	1
	230 V hp	1.5	1
	460/575 V hp	--	--
- 3-phase	At 115 V hp	--	--
	200 V hp	3	3 (1 for 3TF20 ...-6)
	230 V hp	3	3 (1 for 3TF20 ...-6)
	460/575 V hp	5	--
Overload relay	• Type/Setting range	3UA7/EB 8 ... 10 A	

Contactor	Type	3TF2
	Size	
Rated data of the auxiliary contacts acc. to IEC 60947-5-1 (VDE 0660 Part 200)		
Rated insulation voltage U_i (degree of pollution 3)	V	690
Continuous thermal current I_{th} = Rated operational current $I_e/AC-12$	A	10
AC load		
Rated operational current $I_e/AC-15/AC-14$		
• For rated operational voltage U_e		
	24 V A	4
	110 V A	4
	125 V A	4
	220 V A	4
	230 V A	4
	380 V A	3
	400 V A	3
	500 V A	2
	660 V A	1
	690 V A	1
DC load		
Rated operational current $I_e/DC-12$		
• For rated operational voltage U_e		
	24 V A	4
	48 V A	2.2
	110 V A	1.1
	125 V A	1.1
	220 V A	0.5
	440 V A	--
	600 V A	--
Rated operational current $I_e/DC-13$		
• For rated operational voltage U_e		
	24 V A	2.1
	48 V A	1.1
	110 V A	0.52
	125 V A	0.52
	220 V A	0.27
	440 V A	--
	600 V A	--
Ⓢ, Ⓣ and Ⓜ rated data of the auxiliary contacts		
Rated voltage, max.	V AC	600
Auxiliary switch blocks, max.	V AC	300
Switching capacity		A 600, Q 300
Uninterrupted current at 240 V AC	A	10

3RA13, 3RA14 Contactor Assemblies

3RA13 Reversing Contactor Assemblies

3RA13 complete units, 3 ... 45 kW

Overview

The 3RA13 reversing contactor assemblies can be ordered as follows:

Sizes S00 to S3

Fully wired and tested, with mechanical and electrical interlock. For assemblies with AC operation and 50/60 Hz, a dead interval of 50 ms must be provided when used with voltages ≥ 500 V; a dead interval of 30 ms is recommended for use with voltages ≥ 400 V. These dead times do not apply to assemblies with DC operation.

Sizes S00 to S12

As individual parts for customer assembly.

There is also a range of accessories (auxiliary switch blocks, surge suppressors, etc.) that must be ordered separately.

For overload relays for motor protection, see "Protection Equipment --> Overload Relays".

The 3RA13 contactor assemblies have screw terminals and are suitable for screwing or snapping onto 35 mm standard mounting rails.

Complete units

The fully wired reversing contactor assemblies are suitable for use in any climate. They are finger-safe according to EN 50274.

The contactor assemblies consist of 2 contactors with the same power, with one NC contact in the basic unit. The contactors are mechanically and electrically interlocked (NC contact interlock).

For motor protection, either 3RU11 or 3RB2... overload relays for direct mounting or stand-alone installation or thermistor motor protection tripping units must be ordered separately.

Components for customer assembly

Assembly kits for all sizes are available for customer assembly of reversing contactor assemblies.

Contactors, overload relays, the mechanical interlock (as of size S0) and – for momentary-contact operation – auxiliary switch blocks for latching must be ordered separately.

Rated data AC-2 and AC-3 at AC 50 Hz 400 V		Size	Order No.				Assembly kit	Fully wired and tested contactor assemblies
Rating kW	Operational current I_e A		Contactors	Mechanical interlock ¹⁾	Mechanical interlock ²⁾	Mechanical interlock ³⁾		
3	7	S00	3RT10 15	-- ⁴⁾	--	--	3RA19 13-2A ⁵⁾	3RA13 15-8XB30-1 ..
4	9		3RT10 16					3RA13 16-8XB30-1 ..
5.5	12		3RT10 17					3RA13 17-8XB30-1 ..
5.5	12	S0	3RT10 24	3RA19 24-1A	3RA19 24-2B	--	3RA19 23-2A ⁶⁾	3RA13 24-8XB30-1 ..
7.5	17		3RT10 25					3RA13 25-8XB30-1 ..
11	25		3RT10 26					3RA13 26-8XB30-1 ..
15	32	S2	3RT10 34	3RA19 24-1A	3RA19 24-2B	--	3RA19 33-2A ⁷⁾	3RA13 34-8XB30-1 ..
18.5	40		3RT10 35					3RA13 35-8XB30-1 ..
22	50		3RT10 36					3RA13 36-8XB30-1 ..
30	65	S3	3RT10 44	3RA19 24-1A	3RA19 24-2B	--	3RA19 43-2A ⁷⁾	3RA13 44-8XB30-1 ..
37	80		3RT10 45					3RA13 45-8XB30-1 ..
45	95		3RT10 46					3RA13 46-8XB30-1 ..
55	115	S6	3RT10 54	--	--	3RA19 54-2A	3RA19 53-2M ⁸⁾	--
75	150		3RT10 55					
90	185		3RT10 56					
110	225	S10	3RT10 64	--	--	3RA19 54-2A	3RA19 63-2A ⁸⁾	--
132	265		3RT10 65					
160	300		3RT10 66					
200	400	S12	3RT10 75	--	--	3RA19 54-2A	3RA19 73-2A ⁸⁾	--
250	500		3RT10 76					

1) Can be mounted onto the front.

2) Laterally mountable with one auxiliary contact.

3) Laterally mountable without auxiliary contact.

4) Interlock can only be ordered with assembly kit.

5) Assembly kit contains: mechanical interlock; connecting clips for 2 contactors; wiring modules on the top and bottom.

6) Assembly kit contains: wiring modules on the top and bottom.

7) Assembly kit contains: 2 connecting clips for contactors; wiring modules on the top and bottom.

8) Assembly kit contains: wiring module on the top and bottom.

3RA13, 3RA14 Contactor Assemblies

3RA13 Reversing Contactor Assemblies

3RA13 complete units, 3 ... 45 kW

Function

The operating times of the individual 3RT10 contactors are rated in such a way that no overlapping of the contact making and the arcing time between two contactors can occur on reversing, providing they are interlocked by way of their auxiliary switches (NC contact interlock) and the mechanical interlock. For assemblies with AC operation and 50/60 Hz, a dead interval of 50 ms must be provided when used with voltages ≥ 500 V; a dead interval of 30 ms is recommended for use with voltages ≥ 400 V. These dead times do not apply to assemblies with DC operation.

The operating times of the individual contactors are not affected by the mechanical interlock.

The following points should be noted:

Size S00

- For maintained-contact operation:
Use contactors with an NC contact in the basic unit for the electrical interlock.
- For momentary-contact operation:
Use contactors with an NC contact in the basic unit for the electrical interlock; in addition, an auxiliary switch block with at least one NO contact for latching is required per contactor.

Sizes S0 to S3

- For maintained-contact operation:
The contactors have no auxiliary contact in the basic unit; NC contacts for the electrical interlock are therefore integrated in the mechanical interlock that can be mounted on the side of each contactor (one contact each for the left and right-hand contactors).
- For momentary-contact operation:
Electrical interlock as for maintained-contact operation; for the purpose of latching an auxiliary contact with an NO contact is additionally required for each contactor. This contact can be snapped onto the top of the contactors. Alternatively, auxiliary switch blocks mounted on the side can be used; they must be fitted onto the outside of each contactor.

If the front-mounted mechanical interlock is used for size S0 to S3 contactors, two location holes for single-pole auxiliary switch blocks are provided on the front of each S0 or S2 contactor, while three additional, single-pole auxiliary switch blocks can be snapped onto S3 contactors. The maximum auxiliary switch fittings per contactor must not be exceeded.

When size S2 and S3 contactors are combined with a front-mounted mechanical interlock, the assembly kits for 3RA19 33-2B and 3RA19 43-2B contactor assemblies cannot be used.

Sizes S6 to S12

To insert the mechanical interlock, the prestamped location holes positioned opposite on the contactor must be knocked out. The internal auxiliary contacts (up to 1 NO + 1 NC per contactor) can be used for the electrical interlock and latching. The mechanical interlock itself does not contain any auxiliary contacts. Additional auxiliary contacts can be used on the outside and front (on the front in the case of 3RT10) of the reversing contactor assembly.

Surge suppression

Sizes S00 to S3

All contactor assemblies can be fitted with RC elements or varistors for damping opening surges in the coil.



As with the individual contactors, the surge suppressors can either be plugged onto the top of the contactors (S00) or fitted onto the coil terminals on the top or bottom (S0 to S3).

Sizes S6 to S12

The contactors are fitted with varistors as standard.

Technical specifications

The technical specifications are identical to those of the 3RT10 .. contactors listed on page 3/17 onwards.

The  and  approvals only apply to the complete contactor assemblies and not to the individual parts for customer assembly.

3RA13, 3RA14 Contactor Assemblies

3RA14 Contactor Assemblies for Wye-Delta Starting

3RA14 complete units, 3 ... 75 kW

Overview

These 3RA14 contactor assemblies for wye-delta starting are designed for standard applications.

Note:

Contact assemblies for wye-delta starting in special applications such as very heavy starting or wye-delta starting of special motors must be customized. Help with designing such special applications is available from Technical Assistance.

The 3RA14 contactor assemblies for wye-delta starting can be ordered as follows:

Sizes S00 to S3:

Fully wired and tested, with electrical interlock, dead interval of up to 10 s on reversing (size S00 with electrical and mechanical interlocks)

Sizes S00 to S12:

As individual parts for customer assembly.

A dead interval of 50 ms on reversing is already integrated in the time relay function.

There is also a range of accessories (auxiliary switch blocks, surge suppressors, etc.) that must be ordered separately.

For overload relays for motor protection see "Protection Equipment --> Overload Relays --> 3RB2 Solid-State Overload Relays".

The 3RA14 contactor assemblies have screw terminals and are suitable for screwing or snapping onto 35 mm standard mounting rails.

Fully wired and tested 3RA14 contactor assemblies have one unassigned NO contact which is mounted onto the front of the K3 delta contactor.

A solid-state time-delay auxiliary switch block is snapped onto the front of the complete contactor assemblies, size S00 up to 7.5 kW, while a timing relay is mounted onto the side of sizes S0 to S3, 11 kW to 75 kW.

Rated data at AC 50 Hz 400 V			Size			Accessories for customer assembly		
Rating kW	Operational current I_e A	Motor current A		Line/delta contactor	Star contactor	Order No. complete	Timing relay	Assembly kit A, for double infeed
5.5	12	9.5 ... 13.8	S00-S00-S00	3RT10 15	3RT10 15	3RA14 15-8XB31-1...	3RT19 16-2G.51	--
7.5	17	12.1 ... 17		3RT10 17		3RA14 16-8XB31-1...	3RP15 74-1N.30	
11	25	19 ... 25	S0-S0-S0	3RT10 24	3RT10 24	3RA14 23-8XC21-1...	3RP15 74-1N.30	--
15	32	24.1 ... 34		3RT10 26		3RA14 25-8XC21-1...		
18.5	40	34.5 ... 40						
22	50	31 ... 43	S2-S2-S0	3RT10 34	3RT10 26	3RA14 34-8XC21-1...	3RP15 74-1N.30	3RA19 33-2C ³⁾
30	50	48.3 ... 65		3RT10 35		--		
37	80	62.1 ... 77.8	S2-S2-S2		3RT10 34	3RA14 35-8XC21-1...		3RA19 33-2B ³⁾
45	86	69 ... 86		3RT10 36		3RA14 36-8XC21-1...		
55	115	77.6 ... 108.6	S3-S3-S2	3RT10 44	3RT10 35	3RA14 44-8XC21-1...	3RP15 74-1N.30	3RA19 43-2C ³⁾
75	150	120.7 ... 150		3RT10 45	3RT10 36	3RA14 45-8XC21-1...		
90	160	86 ... 160	S6-S6-S3	3RT10 54	3RT10 44	--	3RP15 74-1N.30	--
110	195	86 ... 195						
132	230	86 ... 230			3RT10 55	3RT10 45		
160	280	86 ... 280		3RT10 56	3RT10 46			
200	350	95 ... 350	S10-S10-S6	3RT10 64	3RT10 54	--	3RP15 74-1N.30	--
250	430	95 ... 430		3RT10 65	3RT10 55			
315	540	277 ... 540	S12-S12-S10	3RT10 75	3RT10 64	--	3RP15 74-1N.30	--
355	610	277 ... 610						
400	690	277 ... 690				3RT10 65		
500	850	277 ... 850		3RT10 76	3RT10 66			

1) Assembly kit contains mechanical interlock, 3 connecting clips; wiring modules on the top (connection between line and delta contactor) and on the bottom (connection between delta and star contactor); star jumper.

2) Assembly kit contains 5 connecting clips; wiring modules on the top (connection between line and delta contactor) and on the bottom (connection between delta and star contactor); star jumper.

3) Assembly kit contains wiring module on the bottom (connection between delta and star contactor) and star jumper.

4) Wiring module on top from reversing contactor assembly (note conductor cross-sections).

3RA13, 3RA14 Contactor Assemblies

3RA14 Contactor Assemblies for Wye-Delta Starting

3RA14 complete units, 3 ... 75 kW

Components for customer assembly

Assembly kits with wiring modules and, if necessary, mechanical connectors are available for contactor assemblies for wye-delta starting. Contactors, overload relays, wye-delta timing relays, auxiliary switches for electrical interlock – if required also feeder terminals, mechanical interlocks (exception: In the case of the assembly kit for size S00 contactor assemblies the mechanical interlock between the delta contactor and the star contactor is included in the kit) and base plates – must be ordered separately.

The wiring kits for sizes S00 and S0 contain the top and bottom main conducting path connections between the line and delta contactors (top) and between the delta and star contactors (bottom).

In the case of sizes S2 to S12 only the bottom main conducting path connection between the delta and star contactors is included in the wiring module, owing to the larger conductor cross-section at the infeed.

Motor protection

Overload relays or thermistor motor protection tripping units can be used for overload protection.

The overload relay can be either mounted onto the line contactor or separately fitted. It must be set to 0.58 times the rated motor current.

Note:

The selection of contactor types refers to fused configurations (see table on page 3/88).

Assembly kit B, for single infeed	Star jumper	Base plates	Overload relay, thermal (CLASS 10 trip class)		Overload relay, solid-state (CLASS 10 trip class)	
			Setting range	Order No.	Setting range	Order No.
3RA19 13-2B ¹⁾	3RT19 16-4BA31	--	A 5.5 ... 8 7 ... 10	3RU11 16-1HB0 3RU11 16-1JB0	A 3 ... 12	3RB20 16-1SB0
3RA19 23-2B ²⁾	3RT19 26-4BA31	--	11 ... 16 14 ... 20 20 ... 25	3RU11 26-4AB0 3RU11 26-4BB0 3RU11 26-4DB0	6 ... 25	3RB20 26-1QB0
3RV19 35-1A	3RT19 26-4BA31	3RA19 32-2E	18 ... 25 28 ... 40	3RU11 36-4DB0 3RU11 36-4FB0	12.5 ... 50	3RB20 36-1UB0
	3RT19 36-4BA31	3RA19 32-2F	36 ... 45 40 ... 50	3RU11 36-4GB0 3RU11 36-4HB0		
--	3RT19 36-4BA31	3RA19 42-2E	45 ... 63 70 ... 90	3RU11 46-4JB0 3RU11 46-4LB0	25 ... 100	3RB20 46-1EB0
3RA19 53-3D ⁴⁾	3RT19 46-4BA31	3RA19 52-2E	--	--	50 ... 200	3RB20 56-1FW2
						3RB20 56-1FC2
--	3RT19 56-4BA31	3RA19 62-2E	--	--	55 ... 250	3RB20 66-1GC2
--	3RT19 66-4BA31	3RA19 72-2E	--	--	160 ... 630	3RB20 66-1MC2

For footnotes see page 3/86.

3RA13, 3RA14 Contactor Assemblies

3RA14 Contactor Assemblies for Wye-Delta Starting

3RA14 complete units, 3 ... 75 kW

Function

Wye-delta starting can only be used either if the motor normally operates in a Δ connection or starts softly or if the load torque during Y starting is low and does not increase sharply. On the Y step the motors can carry approximately 50 % (class KL 16) or 30 % (class KL 10) of their rated torque; The tightening torque is approximately 1/3 of that during direct on-line starting. The starting current is approximately 2 to 2.7 times the rated motor current.

The changeover from Y to Δ must not be effected until the motor has run up to rated speed. Operating mechanisms which require this changeover to be performed earlier are unsuitable for wye-delta starting.

The ratings given in the table are only applicable to motors with a starting current ratio $I_A \leq 8.4 \times I_N$ and using either a 3RT19 16-2G or 3RT19 26-2G solid-state time-delay auxiliary

switch block with a wye-delta function or a 3RP15 74. wye-delta timing relay with a dead interval on reversing of approximately 50 ms.

Surge suppression

Sizes S00 to S3:

All contactor assemblies can be fitted with RC elements, varistors or diode assemblies for damping opening surges in the coil.

As with the individual contactors, the surge suppressors can either be plugged onto the top of the contactors (S00) or fitted onto the coil terminals on the top or bottom (S0 to S3).

Sizes S6 to S12:

The contactors are fitted with varistors as standard.

Technical specifications

Short-circuit protection with fuses for motor feeders with short-circuit currents up to 50 kA and 690 V.
For overload relays see "Protection Equipment --> Overload Relays --> 3RB2 Solid-State Overload Relays".

Rating kW	Sizes of contactors K1-K3-K2	Rated motor current A	Overload relay Type	Setting range A (the overload relays must be set to 0.58 times the rated motor current)	Permissible back-up fuses for starters, comprising contactor assemblies and overload relays.					
					Single or double infeed ¹⁾ Fuse links LV HRC DIAZED NEOZED gL/gG operational class Type of coordination		LV HRC TYPE 3ND Operational class aM Type of coordination	@ listed fuses CLASS RK5/L	British Standard Fuses BS88 Type of coordination	
					"1" A	"2" A	"2" A	A	"1" A	"2" A
5.5	S00-S00-S00	12	3RU11 16-1HB0	5.5 ... 8	35	20	10	30	35	20
7.5	S00-S00-S00	16	3RU11 16-1JB0	7 ... 10	35	20	16	40	35	20
11	S0-S0-S0	22	3RU11 26-4AB0	11 ... 16	63	25	20	60	63	25
15	S0-S0-S0	29	3RU11 26-4BB0	14 ... 20	100	35	20	80	100	35
18.5	S0-S0-S0	35	3RU11 26-4DB0	20 ... 25	100	35	20	100	100	35
22	S2-S2-S0	41	3RU11 36-4EB0	22 ... 32	125	63	35	125	125	63
30	S2-S2-S0	55	3RU11 36-4FB0	28 ... 40	125	63	50	150	125	63
37	S2-S2-S2	66	3RU11 36-4GB0	36 ... 45	125	63	50	175	125	63
45	S2-S2-S2	80	3RU11 36-4HB0	40 ... 50	160	80	50	200	160	80
55	S3-S3-S2	97	3RU11 46-4KB0	57 ... 75	250	125	63	300	250	125
75	S3-S3-S2	132	3RU11 46-4LB0	70 ... 90	250	160	80	350	250	160
90	S6-S6-S3	160	3RB20 56-1FC2	50 ... 200	355	315	160	450	355	250
110	S6-S6-S3	195	3RB20 56-1FC2	50 ... 200	355	315	160	450	355	250
132	S6-S6-S3	230	3RB20 56-1FC2	50 ... 200	355	315	160	500	355	315
160	S6-S6-S3	280	3RB20 56-1FC2	50 ... 200	355	315	200	500	355	315
200	S10-S10-S6	350	3RB20 66-1GC2	55 ... 250	500	400	250 ²⁾	700	500	400
250	S10-S10-S6	430	3RB20 66-1MC2	160 ... 630	500	400 ²⁾	315 ²⁾	800	500	400
315	S12-S12-S10	540	3RB20 66-1MC2	160 ... 630	630	500 ²⁾	400 ²⁾	1000	630	450 ²⁾
355	S12-S12-S10	610	3RB20 66-1MC2	160 ... 630	630	500 ²⁾	400 ²⁾	1000	630	450 ²⁾
400	S12-S12-S10	690	3RB20 66-1MC2	160 ... 630	630 ²⁾	500 ²⁾	400 ²⁾	1000	630 ²⁾	450 ²⁾
500	S12-S12-S10	850	3RB20 66-1MC2	160 ... 630	630 ²⁾	500 ²⁾	500 ²⁾	1200	630 ²⁾	500 ²⁾

¹⁾ The maximum rated motor current must not be exceeded.

²⁾ Only double infeed with separately fused feeder lines for line and delta contactor is possible because the maximum possible fuse value lies far below the rated motor current.

3RA13, 3RA14 Contactor Assemblies

3RA14 Contactor Assemblies for Wye-Delta Starting

3RA14 complete units, 3 ... 75 kW

Starter	Sizes S..S..S.. Type 3RA.. ..		00-00-00 14 15	00-00-00 14 16	0-0-0 14 23	0-0-0 14 25	2-2-0 14 34	2-2-2 14 35	2-2-2 14 36	3-3-2 14 44	3-3-2 14 45
<i>All technical specifications not mentioned in the table below are identical to those of the individual 3RT contactors and 3RU overload relays</i>											
Mechanical endurance		Operating cycles	3 million								
Short-circuit protection without overload relay			1)								
Maximum rated current of the fuse											
Main circuit											
Fuse links, gL/gG											
LV HRC 3NA, DIAZED 5SB, NEOZED 5SE											
Single or double infeed											
acc. to IEC 60947-4-1/ EN 60947-4-1											
	• Type of coordination "1"	A	35	35	63	100	125	125	160	250	250
	• Type of coordination "2"	A	20	20	25	35	63	63	80	125	160
Control circuit											
Fuse links, gL/gG											
DIAZED 5SB, NEOZED 5SE											
(short-circuit current $I_k \leq 1$ kA)											
		A	10								
		A	6 ²⁾ , if the auxiliary contact of the overload relay is connected in the contactor coil circuit								
Miniature circuit breaker with C characteristic											
		A	10								
		A	6 ²⁾ , if the auxiliary contact of the overload relay is connected in the contactor coil circuit								
Size of individual contactors	• K1 line contactor • K3 delta contactor • K2 star contactor	Type 3RT Type 3RT Type 3RT	10 15 10 15 10 15	10 17 10 17 10 15	10 24 10 24 10 24	10 26 10 26 10 24	10 34 10 34 10 26	10 35 10 35 10 34	10 36 10 36 10 34	10 44 10 44 10 35	10 45 10 45 10 36
Unassigned auxiliary contacts of the individual contactors											
3)											
Current-carrying capacity with reversing time up to 10 s											
• Rated operational current I_e		At 400 V A 500 V A 690 V A	12 8.7 6.9	17 11.3 9	25 20.8 20.8	40 31.2 22.5	65 55.4 53.7	80 69.3 69.3	86 86 69.3	115 112.6 98.7	150 138.6 138.6
• Rated power for induction motors at 50 Hz and 60 Hz and		At 230 V kW 400 V kW 500 V kW 690 V kW 1000 V kW	3.3 5.8 5.3 5.8 --	4.7 8.2 6.9 7.5 --	7.2 12.5 13 18 --	12 21 20.5 20.4 --	20.4 35 38 51 --	25.5 44 48 66 --	27.8 48 60 67 --	37 65 80 97 --	49 85 98 136 --
• Switching frequency with overload relay		h^{-1}	15	15	15	15	15	15	15	15	15
Current-carrying capacity with reversing time up to 15 s											
• Rated operational current I_e		At 400 V A 500 V A 690 V A	12 8.7 6.9	17 11.3 9	25 20.8 20.8	31 28 22.5	44 39 44	57 51 57	67 67 67	97 97 97	106 106 106
• Rated power for induction motors at 50 Hz and 60 Hz and		At 230 V kW 400 V kW 500 V kW 690 V kW 1000 V kW	3.3 5.8 5.3 5.8 --	4.7 8.2 6.9 7.5 --	7.2 12.5 13 18 --	9.4 16.3 20.4 20.4 --	13.8 24 30 42 --	18.2 31.6 40 55 --	21.6 38 47 65 --	32 55 69 95 --	35 60 75 104 --
• Switching frequency with overload relay		h^{-1}	15	15	15	15	15	15	15	15	15
Current-carrying capacity with reversing time up to 20 s											
• Rated operational current I_e		At 400 V A 500 V A 690 V A	12 8.7 6.9	17 11.3 9	25 20.8 20.8	28 28 22.5	39 39 39	51 51 51	57 57 57	85 85 85	92 92 92
• Rated power for induction motors at 50 Hz and 60 Hz and		At 230 V kW 400 V kW 500 V kW 690 V kW 1000 V kW	3.3 5.8 5.3 5.8 --	4.7 8.2 6.9 7.5 --	7.2 12.5 13 18 --	8.5 14.7 18.4 20.4 --	12.2 21.3 26.7 37 --	16.3 28 35 49 --	18.4 32 40 55 --	28 48 60 83 --	30 52 65 90 --
• Switching frequency with overload relay		h^{-1}	15	15	15	15	15	15	15	15	15

1) For short-circuit protection with overload relays see "Protection Equipment --> Overload Relays --> 3RB2 Solid-State Overload Relays".

2) Up to $I_k < 0.5$ kA; ≤ 260 V.

3) For circuit diagrams of the control circuit see page 3/238.

3TD, 3TE Contactor Assemblies

3TD6 reversing contactor assemblies, 335 kW

Overview

The contactor assemblies are suitable for use in any climate and the contactors are mechanically interlocked. They are finger-safe according to EN 50274.

Complete units and components for customer assembly are available. For motor protection, either overload relays for stand-alone installation or thermistor motor protection tripping units must be ordered separately.

Complete units

3TD68 contactor assemblies each consist of two mechanically interlocked 3TF68 contactors. Electrical interlocking is wired. The main and control circuits are wired according to the schematics.

An internal circuit diagram, a type designation and an unit labeling plate are provided on a common cover.

Auxiliary contacts

The contactor assemblies each have 2 NO + 2 NC contacts per contactor. 1 NO + 1 NC contacts with momentary-contact operation and 2 NO + 1 NC contacts with continuous operation are unassigned.

Function

The operating times of the individual contactors are rated in such a way that no overlapping of the contact making and the arcing time between two contactors can occur on reversing, providing they are interlocked via their auxiliary switches and the operating mechanisms.

The operating times of the individual contactors are not affected by the mechanical interlock.

Technical specifications

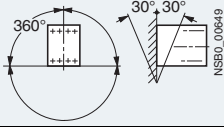
Contactors	Type	3TD68	
General data			
Permissible mounting position, installation instructions¹⁾			
The contactors are designed for operation on a vertical mounting surface.			
			
Ⓢ and Ⓜ ratings			
Rated insulation voltage	V AC	600	
Uninterrupted current enclosed	A	550	
Maximum horsepower ratings (Ⓢ and Ⓜ approved values)			
• Rated power for induction motors at 60 Hz	At 200 V	hp	200
	230 V	hp	229
	460 V	hp	464
	575 V	hp	582
NEMA/EEMAC ratings			
	NEMA/EEMAC SIZE	6	
• Uninterrupted current	- Open	A	600
	- Enclosed	A	540
• Rated power for induction motors with 60 Hz	At 200 V	hp	150
	230 V	hp	200
	460 V	hp	400
	575 V	hp	400
Overload relays	• Type	3RB20 66	
	• Setting range	A	160 ... 630

For short-circuit protection with overload relays see "Protection Equipment --> Overload Relays --> 3RB2 Solid-State Overload Relays".

The technical specifications are identical to those of the 3TF68 individual contactors.

The mechanical endurance is 5 million operating cycles for 3TD68.

For the unassigned auxiliary contacts of the individual contactors, see "Circuit Diagrams of the Control Circuits".

¹⁾ If the contactors are mounted at a 90° angle (conducting paths horizontally one above the other), the following reductions apply: switching frequency: to 80 % of the standard values.

3TE6 contactor assemblies for wye-delta starting,
630 kW

Overview

The contactor assemblies are suitable for use in any climate. They are finger-safe according to EN 50274.

3TE contactor assemblies are available as complete units and components for customer assembly.

The complete unit combinations are optionally supplied without a main conducting path connection between the line contactor and the delta contactor.

Motor protection

3TE68 contactor assemblies are supplied without overload protection. Overload relays or thermistor motor protection tripping units must be ordered separately.

The overload relay can be either mounted onto the line contactor or separately fitted. It must be set to 0.58 times the rated motor current.

Function

Wye-delta starting can only be used either if the motor normally operates in a Δ connection or starts softly or if the load torque during Y starting is low and does not increase sharply. On the Y step the motors can carry approximately 50 % (class KL 16) or 30 % (class KL 10) of their rated torque; The tightening torque is approximately 1/3 of that during direct on-line starting. The starting current is approximately 2 to 2.7 times the rated motor current.

The changeover from Y to Δ must not be effected until the motor has run up to rated speed. Operating mechanisms which require this changeover to be performed earlier are unsuitable for wye-delta starting.

The ratings given in the selection table are only applicable to motors with a starting current ratio of $I_A \leq 8.4 \times I_N$ and using a 3RP15 74 wye-delta timing relay with a dead interval of approximately 50 ms on reversing.

Technical specifications

Starter	Type	3TE68		
General data				
Permissible mounting position, installation instructions¹⁾				
The contactors are designed for operation on a vertical mounting surface.				
Mechanical endurance	Operating cycles	3 million		
Type of individual contactors	<ul style="list-style-type: none"> • K1 line contactor • K3 delta contactor • K2 star contactor 	Type	3TF68	
		Type	3TF68	
		Type	3RT10 75	
Unassigned auxiliary contacts of the individual contactors				
2)				
Current-carrying capacity with reversing time up to 10 s				
• Rated operational current I_e	Up to 690 V	A	1090	
• Rated power for induction motors at 50 Hz	At 230 V	kW	355	
	400 V	kW	612	
	500 V	kW	800	
	690 V	kW	1046	
• Switching frequency with overload relay		h^{-1}	3	
Current-carrying capacity with reversing time up to 15 s				
• Rated operational current I_e	Up to 500 V	A	923	
	690 V	A	883	
• Rated power for induction motors at 50 Hz	At 230 V	kW	295	
	400 V	kW	515	
	500 V	kW	677	
	690 V	kW	885	
• Switching frequency with overload relay		h^{-1}	2	
Current-carrying capacity with reversing time up to 20 s				
• Rated operational current I_e	Up to 500 V	A	800	
	690 V	A	765	
• Rated power for induction motors at 50 Hz	At 230 V	kW	244	
	400 V	kW	444	
	500 V	kW	590	
	690 V	kW	770	
• Switching frequency with overload relay		h^{-1}	2	
Short-circuit protection				
Main circuit				
Fuse links, gL/gG				
LV HRC 3NA, DIAZED 5SB, NEOZED 5SE				
Acc. to IEC 60947-4-1/ EN 60947-4-1	• Type of coordination "1"	A	1000	
	• Type of coordination "2"	A	500 ³⁾	
Auxiliary circuit				
• Fuse links gL/gG (weld-free protection at $I_k \geq 1$ kA) DIAZED 5SB, NEOZED 5SE		A	10	
• Or miniature circuit breakers with C characteristic ($I_k < 400$ A)				

¹⁾ If the contactors are mounted at a 90° angle (conducting paths horizontally one above the other), the following reductions apply: switching frequency: to 80 % of the standard values.

²⁾ See "Circuit diagrams of the control circuits".

³⁾ The maximum rated motor current must not be exceeded.

3TD, 3TE Contactor Assemblies

3TE6 contactor assemblies for wye-delta starting, 630 kW

Contactor assembly	Type	3TE68
Short-circuit protection with fuses for motor feeders with short-circuit currents up to 50 kA and 690 V		
Rated motor current	A	277 ... 1090
Overload relays	Type	3RB20 66
Setting range (the overload relays must be set to 0.58 times the rated motor current)	A	160 ... 630
Permissible back-up fuses for starters, comprising contactor assemblies and overload relays. Single or double infeed ¹⁾		
<ul style="list-style-type: none"> • Fuse links LV HRC Type 3NA, DIAZED Type 5SB, NEOZED Type 5SE <ul style="list-style-type: none"> - Type of coordination "1" - Type of coordination "2" • Fuse links LV HRC type 3ND, aM operational class <ul style="list-style-type: none"> - Type of coordination "2" • Fuse links, Siemens Canada, HRC fuses, Type II • Fuse links UL-listed fuses CLASS L • Fuse links British Standard Fuses BS88 <ul style="list-style-type: none"> - Type of coordination "1" - Type of coordination "2" 	<ul style="list-style-type: none"> A A A A A A A A 	<ul style="list-style-type: none"> 1000 500 630 1000 1200 1000 500

For short-circuit protection with overload relays see "Protection Equipment --> Overload Relays --> 3RB2 Solid-State Overload Relays".

Use double infeed for higher rated motor currents (see "Circuit diagram").

¹⁾ The maximum rated motor current must not be exceeded.

3RT, 3RH, 3TB, 3TC, 3TH, 3TK Contactors for Special Applications

3RT14 Contactors for Switching Resistive Loads (AC-1)

3-pole, 140 ... 690 A

Overview

AC and DC operation (size S3)

UC operation (AC/DC) (sizes S6 to S12)

IEC 60947, EN 60947 (VDE 0660)



The contactors are suitable for use in any climate. They are finger-safe according to EN 50274.

3RT14 contactors are used for switching resistive loads (AC-1) or as contactors, for example, for variable-speed operating mechanisms that normally only have to carry the current.

The accessories for the 3RT10 contactors can also be used here.

For more detailed descriptions about the sizes S6 to S12, see "3RT10 Contactors, 3-pole, 3 ... 250 kW".

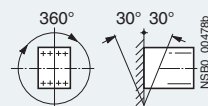
Technical specifications

Contactor	Type Size	3RT14 46 S3	
General data			
Permissible mounting position The contactors are designed for operation on a vertical mounting surface.	• AC and DC operation	 <p>For DC operation and 22.5 °C inclination towards the front, operating range 0.85 ... 1.1 x U_g</p>	
Upright mounting position:	• AC operation	 <p>Special version required.</p>	
	• DC operation	--	
Mechanical endurance	Operating cycles	10 million	
Electrical endurance in operating cycles Utilization category AC-1 at I_e	Operating cycles	0.5 million	
Rated insulation voltage U_i (degree of pollution 3)	V	1000	
Rated impulse withstand voltage U_{imp}	kV	6	
Protective separation between the coil and the main contacts acc. to EN 60947-1, Appendix N	V	690	
Mirror contacts • A mirror contact is an auxiliary NC contact that cannot be closed simultaneously with a NO main contact.	- Removable auxiliary switch block - Permanently fitted auxiliary switch block	Yes, acc. to EN 60947-4-1, Appendix F Acc. to Swiss regulations (SUVA) on request	
Permissible ambient temperature	• During operation • During storage	°C °C	-25 ... +60 -55 ... +80
Degree of protection acc. to EN 60947-1, Appendix C		IP20 (terminal compartment IP00), AC coil assembly IP40, DC coil assembly IP30	
Touch protection acc. to EN 50274		Finger-safe	
Shock resistance			
• Rectangular pulse	AC and DC operation	g/ms	6.8/5 and 4/10
• Sine pulse	AC and DC operation	g/ms	10.6/5 and 6.2/10
Conductor cross-sections			1)
Short-circuit protection for contactors without overload relays			
Main circuit Fuse links, gL/gG operational class, LV HRC, 3NA	• Type of coordination "1":	A	250
Fuse links, gR operational class, SITOR 3NE	• Type of coordination "2"	A	250
Auxiliary circuit			
• Fuse links gL/gG (weld-free protection at $I_k \geq 1$ kA) DIAZED 5SB, NEOZED 5SE		A	10
• Or miniature circuit breakers with C characteristic ($I_k < 400$ A)		A	10

1) For conductor cross-sections see page 3/96.

3RT, 3RH, 3TB, 3TC, 3TH, 3TK Contactors for Special Applications

3RT14 Contactors for Switching Resistive Loads (AC-1)

3-pole, 140 ... 690 A

Contactor	Type Size	3RT14 46 S3	
Control			
Magnetic coil operating range		AC/DC	0.8 ... 1.1 x U_s
Power consumption of the magnetic coils (when coil is cold and $1.0 \times U_s$)			
Standard version:			
• AC operation, 50 Hz	Closing	VA	270
	P.f.		0.68
• AC operation, 50/60 Hz	Closed	VA	22
	P.f.		0.27
	Closing	VA	298/274
	P.f.		0.7/0.62
For USA and Canada: • AC operation, 50 Hz	Closed	VA	27/20
	P.f.		0.29/0.31
	Closing	VA	270
	P.f.		0.68
• AC operation, 60 Hz	Closed	VA	22
	P.f.		0.27
	Closing	VA	300
	P.f.		0.52
• DC operation	Closing	VA	21
	P.f.		0.29
• DC operation	Closing = Closed	W	15
Operating times for 0.8 ... 1.1 x U_s ¹⁾			
Total break time = Opening delay + Arcing time			
• AC operation	- Closing delay	ms	17 ... 90
	- Opening delay	ms	10 ... 25
• DC operation	- Closing delay	ms	90 ... 230
	- Opening delay	ms	14 ... 20
• Arcing time		ms	10 ... 15
Operating times for 1.0 x U_s ¹⁾			
• AC operation	- Closing delay	ms	18 ... 30
	- Opening delay	ms	11 ... 23
• DC operation	- Closing delay	ms	100 ... 120
	- Opening delay	ms	16 ... 20

¹⁾ The OFF-delay of the NO contact and the ON-delay of the NC contact are increased if the contactor coils are attenuated against voltage peaks (varistor +2 ms to 5 ms, diode assembly: 2 to 6 times).

3RT, 3RH, 3TB, 3TC, 3TH, 3TK Contactors for Special Applications

3RT14 Contactors for Switching Resistive Loads (AC-1)





3-pole, 140 ... 690 A

Contactors	Type Size	3RT14 46 S3	
Main circuit			
AC capacity			
Utilization category AC-1, switching resistive loads			
• Rated operational currents I_e	At 40 °C up to 690 V	A	140
	At 60 °C up to 690 V	A	130
	At 1000 V	A	60
• Ratings of AC loads P.f. = 0.95 (at 60 °C)	At 230 V	kW	50
	400 V	kW	86
	500 V	kW	107
	690 V	kW	148
	1000 V	kW	98
• Minimum conductor cross-section for loads with I_e	At 40 °C	mm ²	50
	At 60 °C	mm ²	50
Utilization category AC-2 and AC-3			
With an electrical endurance of 1.3 million operating cycles			
• Rated operational current I_e	Up to 690 V	A	44
• Rated power of slipping or squirrel-cage motors at 50 Hz and 60 Hz (at 60 °C)	At 230 V	kW	12.7
	400 V	kW	22
	500 V	kW	29.9
	690 V	kW	38.2
Power loss per conducting path	At $I_e/AC-1$	W	12.5
Load rating with DC			
Utilization category DC-1, switching resistive loads ($L/R \leq 1$ ms)			
• Rated operational currents I_e (at 60 °C)			
- 1 conducting path	Up to 24 V	A	130
	60 V	A	80
	110 V	A	12
	220 V	A	2.5
	440 V	A	0.8
	600 V	A	0.48
- 2 conducting paths in series	Up to 24 V	A	130
	60 V	A	130
	110 V	A	130
	220 V	A	13
	440 V	A	2.4
	600 V	A	1.3
- 3 conducting paths in series	Up to 24 V	A	130
	60 V	A	130
	110 V	A	130
	220 V	A	130
	440 V	A	6
	600 V	A	3.4
Utilization category DC-3/DC-5			
Shunt-wound and series-wound motors ($L/R \leq 15$ ms)			
• Rated operational currents I_e (at 60 °C)			
- 1 conducting path	Up to 24 V	A	6
	60 V	A	3
	110 V	A	1.25
	220 V	A	0.35
	440 V	A	0.15
	600 V	A	0.1
- 2 conducting paths in series	Up to 24 V	A	130
	60 V	A	130
	110 V	A	130
	220 V	A	1.75
	440 V	A	0.42
	600 V	A	0.27
- 3 conducting paths in series	Up to 24 V	A	130
	60 V	A	130
	110 V	A	130
	220 V	A	4
	440 V	A	0.8
	600 V	A	0.45
Switching frequency			
Switching frequency z in operating cycles/hour			
• Contactors without overload relays	No-load switching frequency AC	1/h	5000
	No-load switching frequency DC	1/h	1000
• Rated operation	Acc. to AC-1 (AC/DC)	1/h	650
	Acc. to AC-3 (AC/DC)	1/h	1000
Dependence of the switching frequency z' on the operational current I' and operational voltage U' : $z' = z \cdot (I_e/I') \cdot (400 V/U')^{1.5} \cdot 1/h$.			

3RT, 3RH, 3TB, 3TC, 3TH, 3TK Contactors for Special Applications

3RT14 Contactors for Switching Resistive Loads (AC-1)

3-pole, 140 ... 690 A

Contactor	Type Size	3RT14 46 S3	
Conductor cross-sections			
(1 or 2 conductors can be connected) Front clamping point connected 	Main conductors: <u>With box terminal</u>		 Screw terminals
	<ul style="list-style-type: none"> • Finely stranded with end sleeve • Finely stranded without end sleeve • Solid • Stranded • Ribbon cable conductors (number x width x thickness) • AWG cables, solid or stranded 	mm ² 2.5 ... 50 mm ² 4 ... 50 mm ² 2.5 ... 16 mm ² 4 ... 70 mm 6 x 9 x 0.8 AWG 10 ... 2/0	
Rear clamping point connected 	<ul style="list-style-type: none"> • Finely stranded with end sleeve • Finely stranded without end sleeve • Solid • Stranded • Ribbon cable conductors (number x width x thickness) • AWG cables, solid or stranded 		mm ² 2.5 ... 50 mm ² 10 ... 50 mm ² 2.5 ... 16 mm ² 10 ... 70 mm 6 x 9 x 0.8 AWG 10 ... 2/0
	Both clamping points connected 	<ul style="list-style-type: none"> • Finely stranded with end sleeve • Finely stranded without end sleeve • Solid • Stranded • Ribbon cable conductors (number x width x thickness) • AWG cables, solid or stranded • Terminal screws - Tightening torque 	
Connection for drilled copper bars		Max. width ¹⁾	mm
Main conductors:			
<u>Without box terminal with cable lugs²⁾</u>			
<ul style="list-style-type: none"> • Finely stranded with cable lug • Stranded with cable lug • AWG cables, solid or stranded 		mm ² 10 ... 50 ³⁾ mm ² 10 ... 70 ³⁾ AWG 7 ... 1/0	
Auxiliary conductors:			
<ul style="list-style-type: none"> • Solid • Finely stranded with end sleeve • AWG cables, solid or stranded • Terminal screws - Tightening torque 		mm ² 2 x (0.5 ... 1.5) 2 x (0.75 ... 2.5) acc. to IEC 60947; max. 2 x (0.75 ... 4) mm ² 2 x (0.5 ... 1.5) 2 x (0.75 ... 2.5) AWG 2 x (20 ... 16) 2 x (18 ... 14) 1 x 12 Nm M3 0.8 ... 1.2 (7 ... 10.3 lb.in)	

¹⁾ If bars larger than 12 x 10 mm are connected, a 3RT19 46-4EA1 terminal cover is needed to comply with the phase clearance.

²⁾ When connecting rails which are larger than 25 mm², the 3RT19 46-4EA1 terminal cover must be used to keep the phase clearance.

³⁾ Only with crimped cable lugs according to DIN 46234. Cable lug max. 20 mm wide.

3RT, 3RH, 3TB, 3TC, 3TH, 3TK Contactors for Special Applications

3RT14 Contactors for Switching Resistive Loads (AC-1)

3-pole, 140 ... 690 A

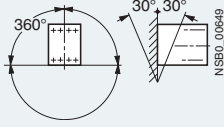
Contactors	Type Size	3RT14 56 S6	3RT14 66 S10	3RT14 76 S12	
General data					
Permissible mounting position The contactors are designed for operation on a vertical mounting surface.					
Mechanical endurance	Operating cycles	10 million			
Electrical endurance Utilization category AC-1 at I_e	Operating cycles	0.5 million			
Rated insulation voltage U_i (degree of pollution 3)	V	1000			
Rated impulse withstand voltage U_{imp}	kV	8			
Protective separation between the coil and the auxiliary contacts and main contacts acc. to EN 60947-1, Appendix N	V	690			
Mirror contacts A mirror contact is an auxiliary NC contact that cannot be closed simultaneously with a NO main contact.		Yes, acc. to EN 60947-4-1, Appendix F			
Permissible ambient temperature	<ul style="list-style-type: none"> • During operation • During storage 	°C	-25 ... +60/+55 with AS-Interface		
		°C	-55 ... +80		
Degree of protection acc. to EN 60947-1, Appendix C			IP00/open, coil assembly IP20		
Touch protection acc. to EN 50274			Finger-safe with cover		
Shock resistance	<ul style="list-style-type: none"> • Rectangular pulse • Sine pulse 	g/ms	8.5/5 and 4.2/10		
		g/ms	13.4/5 and 6.5/10		
Conductor cross-sections			1)		
Electromagnetic compatibility (EMC)			2)		
Short-circuit protection					
Main circuit					
Fuse links gL/gG	• Type of coordination *1*:	A	355	500	800
LV HRC 3NA					
Fuse links gR, SITOR 3NE	• Type of coordination *2*:	A	350	500	710
Auxiliary circuit					
• Fuse links gL/gG (weld-free protection at $I_k \geq 1$ kA) DIAZED 5SB, NEOZED 5SE		A	10		
• Or miniature circuit breakers with C characteristic (short-circuit current $I_k < 400$ A)					

1) For conductor cross-sections see pages 3/100, 3/101.

2) For electromagnetic compatibility (EMC) see page 3/12.

3RT, 3RH, 3TB, 3TC, 3TH, 3TK Contactors for Special Applications

3RT14 Contactors for Switching Resistive Loads (AC-1)

3-pole, 140 ... 690 A

Contactors	Type Size		3RT14 56 S6	3RT14 66 S10	3RT14 76 S12	
Control						
Operating range of the solenoid	AC/DC (UC)		0.8 x $U_{s \min}$... 1.1 x $U_{s \max}$			
Power consumption of the solenoid (when coil is cool and rated range $U_{s \min}$... $U_{s \max}$)						
• Conventional operating mechanism						
- AC operation	Closing at $U_{s \min}$	VA/p.f.	250/0.9	490/0.9	700/0.9	
	Closing at $U_{s \max}$	VA/p.f.	300/0.9	590/0.9	830/0.9	
	Closed at $U_{s \min}$	VA/p.f.	4.8/0.8	5.6/0.9	7.6/0.9	
	Closed at $U_{s \max}$	VA/p.f.	5.8/0.8	6.7/0.9	9.2/0.9	
- DC operation	Closing at $U_{s \min}$	W	300	540	770	
	Closing at $U_{s \max}$	W	360	650	920	
	Closed at $U_{s \min}$	W	4.3	6.1	8.5	
	Closed at $U_{s \max}$	W	5.2	7.4	10	
• Solid-state operating mechanism						
- AC operation	Closing at $U_{s \min}$	VA/p.f.	190/0.8	400/0.8	560/0.8	
	Closing at $U_{s \max}$	VA/p.f.	28/0.8	530/0.8	750/0.8	
	Closed at $U_{s \min}$	VA/p.f.	3.5/0.5	4/0.5	5.4/0.8	
	Closed at $U_{s \max}$	VA/p.f.	4/0.4	5/0.4	7/0.8	
- DC operation	Closing at $U_{s \min}$	W	250	440	600	
	Closing at $U_{s \max}$	W	320	580	800	
	Closed at $U_{s \min}$	W	2.3	3.2	4	
	Closed at $U_{s \max}$	W	2.8	3.8	5	
PLC control input (EN 61131-2/type 2)			24 V DC/≤ 30 mA power consumption, (operating range 17 ... 30 V DC)			
Operating times (Total break time = Opening delay + Arcing time)						
• Conventional operating mechanism						
- With 0.8 x $U_{s \min}$... 1.1 x $U_{s \max}$	Closing delay	ms	20 ... 95	30 ... 95	45 ... 100	
	Opening delay	ms	40 ... 60	40 ... 80	60 ... 100	
- For $U_{s \min}$... $U_{s \max}$	Closing delay	ms	25 ... 50	35 ... 50	50 ... 70	
	Opening delay	ms	40 ... 60	50 ... 80	70 ... 100	
• Solid-state operating mechanism, actuated via A1/A2						
- With 0.8 x $U_{s \min}$... 1.1 x $U_{s \max}$	Closing delay	ms	95 ... 135	105 ... 145	120 ... 150	
	Opening delay	ms	80 ... 90	80 ... 200	80 ... 100	
- For $U_{s \min}$... $U_{s \max}$	Closing delay	ms	100 ... 120	110 ... 130	125 ... 150	
	Opening delay	ms	80 ... 90	80 ... 100	80 ... 100	
• Solid-state operating mechanism, actuated via PLC input						
- With 0.8 x $U_{s \min}$... 1.1 x $U_{s \max}$	Closing delay	ms	35 ... 75	45 ... 80	60 ... 90	
	Opening delay	ms	80 ... 90	80 ... 100	80 ... 100	
- For $U_{s \min}$... $U_{s \max}$	Closing delay	ms	40 ... 60	50 ... 65	65 ... 80	
	Opening delay	ms	80 ... 90	80 ... 100	80 ... 100	
• Arcing time						
		ms	10 ... 15	10 ... 15	10 ... 15	
Main circuits						
AC capacity						
Utilization category AC-1, switching resistive loads						
• Rated operational currents I_e	At 40 °C up to 690 V A		275	400	690	
	At 60 °C up to 690 V A		250	380	650 ¹⁾	
• Rated power for AC loads ²⁾ P.f. = 0.95 (at 60 °C)	At 1000 V A		100	150	250	
	At 230 V kW		95	145	245	
	400 V kW		165	250	430	
	500 V kW		205	315	535	
	690 V kW		285	430	740	
	1000 V kW		165	247	410	
• Minimum conductor cross-section for loads with I_e	At 40 °C mm ²		2 x 70	240	2 x 240	
	At 60 °C mm ²		120	240	2 x 240	
Power loss per conducting path			At I_e /AC-1 W	20	27	55
Utilization category AC-2 and AC-3 for an electrical endurance of 1.3 million operating cycles						
• Rated operational current I_e	Up to 690 V A		97	138	170	
• Rated power of slipping or squirrel-cage motors at 50 Hz and 60 Hz (at 60 °C)	At 230 V kW		30	37	55	
	400 V kW		55	75	90	
	500 V kW		55	90	110	
	690 V kW		90	132	160	

1) 600 A for 3RT14 76-N contactor.

2) Industrial furnaces and electric heaters with resistance heating, etc.
(increased power consumption on heating up taken into account).

3RT, 3RH, 3TB, 3TC, 3TH, 3TK Contactors for Special Applications

3RT14 Contactors for Switching Resistive Loads (AC-1)

3-pole, 140 ... 690 A

Contactors	Type Size		3RT14 56 S6	3RT14 66 S10	3RT14 76 S12
Main circuit					
<i>Load rating with DC</i>					
Utilization category DC-1, switching resistive loads ($L/R \leq 1$ ms)					
• Rated operational currents I_e (at 60 °C)					
- 1 conducting path		Up to 24 V A	250	380	500
		60 V A	250	380	500
		110 V A	18	33	33
		220 V A	3.4	3.8	3.8
		440 V A	0.8	0.9	0.9
		600 V A	0.5	0.6	0.6
- 2 conducting paths in series		Up to 24 V A	250	380	500
		60 V A	250	380	500
		110 V A	250	380	500
		220 V A	20	380	500
		440 V A	3.2	4	4
		600 V A	1.6	2	2
- 3 conducting paths in series		Up to 24 V A	250	380	500
		60 V A	250	380	500
		110 V A	250	380	500
		220 V A	250	380	500
		440 V A	11.5	11	11
		600 V A	4	5.2	5.2
Utilization category DC-3/DC-5					
Shunt-wound and series-wound motors ($L/R \leq 15$ ms)					
• Rated operational currents I_e (at 60 °C)					
- 1 conducting path		Up to 24 V A	250	380	500
		60 V A	7.5	11	11
		110 V A	2.5	3	3
		220 V A	0.6	0.6	0.6
		440 V A	0.17	0.18	0.18
		600 V A	0.12	0.125	0.125
- 2 conducting paths in series		Up to 24 V A	250	380	500
		60 V A	250	380	500
		110 V A	250	380	500
		220 V A	2.5	2.5	2.5
		440 V A	0.65	0.65	0.65
		600 V A	0.37	0.37	0.37
- 3 conducting paths in series		Up to 24 V A	250	380	500
		60 V A	250	380	500
		110 V A	250	380	500
		220 V A	250	380	500
		440 V A	1.4	1.4	1.4
		600 V A	0.75	0.75	0.75

Switching frequency**Switching frequency z** in operating cycles/hour

• Contactors without overload relays	No-load switching frequency	h ⁻¹	2000
		AC-1 h ⁻¹	600
		AC-3 h ⁻¹	1000





Dependence of the switching frequency z' on the operational current I' and operational voltage U' :

$$z' = z \cdot (I_e/I') \cdot (400 V/U')^{1.5} \cdot 1/h$$

3RT, 3RH, 3TB, 3TC, 3TH, 3TK Contactors for Special Applications

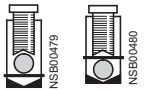
3RT14 Contactors for Switching Resistive Loads (AC-1)

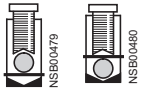
3-pole, 140 ... 690 A

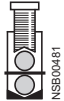
Contactor	Type Size	3RT14 56 S6	
Conductor cross-sections			
Front or rear clamping point connected 	Main conductors: With 3RT19 55-4G box terminal		 Screw terminals
	<ul style="list-style-type: none"> • Finely stranded with end sleeve • Finely stranded without end sleeve • Stranded • Ribbon cable conductors (number x width x thickness) • AWG cables, solid or stranded 	mm ² 16 ... 70 mm ² 16 ... 70 mm ² 16 ... 70 mm 3 x 9 x 0.8 ... 6 x 15.5 x 0.8 AWG 6 ... 2/0	
Both clamping points connected 	<ul style="list-style-type: none"> • Finely stranded with end sleeves, max. • Finely stranded without end sleeve • Stranded (max.) • Ribbon cable conductors (number x width x thickness), max. • AWG cables, solid or stranded, max. 	mm ² 1 x 50, 1 x 70 mm ² 1 x 50, 1 x 70 mm ² 2 x 70 mm 2 x (6 x 15.5 x 0.8) AWG 2 x 1/0	
Front or rear clamping point connected 	Main conductor With 3RT19 56-4G box terminal		 Screw terminals
	<ul style="list-style-type: none"> • Finely stranded with end sleeve • Finely stranded without end sleeve • Stranded • Ribbon cable conductors (number x width x thickness) • AWG cables, solid or stranded 	mm ² 16 ... 120 mm ² 16 ... 120 mm ² 16 ... 120 mm 3 x 9 x 0.8 ... 10 x 15.5 x 0.8 AWG 6 ... 250 kcmil	
Both clamping points connected 	<ul style="list-style-type: none"> • Finely stranded with end sleeves, max. • Finely stranded without end sleeve • Stranded (max.) • Ribbon cable conductors (number x width x thickness), max. • AWG cables, solid or stranded, max. • Terminal screws <ul style="list-style-type: none"> - Tightening torque 	mm ² 1 x 95, 1 x 120 mm ² 1 x 95, 1 x 120 mm ² 2 x 120 mm 2 x (10 x 15.5 x 0.8) AWG 2 x 3/0 Nm M10 (hexagon socket, A/F4) 10 ... 12 (90 ... 110 lb.in)	
Main conductors: Without box terminal/busbar connection ¹⁾		<ul style="list-style-type: none"> • Finely stranded with cable lug • Stranded with cable lug • AWG cables, solid or stranded • Connecting bar (max. width) • Terminal screw <ul style="list-style-type: none"> - Tightening torque 	16 ... 95 25 ... 120 4 ... 250 kcmil 17 M8 x 25 (A/F 13) Nm 10 ... 14 (90 ... 110) lb.in
Auxiliary conductors:		<ul style="list-style-type: none"> • Conductor cross-section <ul style="list-style-type: none"> - Solid - Finely stranded with end sleeve - Solid or stranded AWG (2 x) • Terminal screw <ul style="list-style-type: none"> - Tightening torque 	2 x (0.5 ... 1.5) ² ; 2 x (0.75 ... 2.5) ² acc. to IEC 60947; max. 2 x (0.75 ... 4) 2 x (0.5 ... 1.5) ² ; 2 x (0.75 ... 2.5) ² 2 x (18 ... 14) M3 (PZ 2) Nm 0.8 ... 1.2 (7 ... 10.3) lb.in



¹⁾ When connecting cable lugs according to DIN 46235, use the 3RT19 56-4EA1 terminal cover for conductor cross-sections from 95 mm² to ensure phase spacing.

²⁾ If two different conductor cross-sections are connected to one clamping point, both cross-sections must lie in the range specified. If identical cross-sections are used, this restriction does not apply.

3RT, 3RH, 3TB, 3TC, 3TH, 3TK Contactors for Special Applications

3RT14 Contactors for Switching Resistive Loads (AC-1)

3-pole, 140 ... 690 A

Contactors	Type Size	3RT14 66 S10	3RT14 76 S12
Conductor cross-sections			
(1 or 2 conductors can be connected)	Main conductors: <u>With 3RT19 66-4G box terminal</u>	⊕ Screw terminals	
Front clamping point connected  NSB00479	<ul style="list-style-type: none"> • Finely stranded with end sleeve mm² • Finely stranded without end sleeve mm² • Stranded mm² • AWG cables, solid or stranded AWG • Ribbon cable conductors (number x width x thickness) mm 	70 ... 240 70 ... 240 95 ... 300 3/0 ... 600 kcmil	Min. 6 x 9 x 0.8, max. 20 x 24 x 0.5
Rear clamping point connected  NSB00480	<ul style="list-style-type: none"> • Finely stranded with end sleeve mm² • Finely stranded without end sleeve mm² • Stranded mm² • AWG cables, solid or stranded AWG • Ribbon cable conductors (number x width x thickness) mm 	120 ... 185 120 ... 185 120 ... 240 250 ... 500 kcmil	Min. 6 x 9 x 0.8, max. 20 x 24 x 0.5
Both clamping points connected  NSB00481	<ul style="list-style-type: none"> • Finely stranded with end sleeve mm² • Finely stranded without end sleeve mm² • Stranded mm² • AWG cables, solid or stranded AWG • Ribbon cable conductors (number x width x thickness) mm • Terminal screws - Tightening torque Nm 	Min. 2 x 50, max. 2 x 185 Min. 2 x 50, max. 2 x 185 Min. 2 x 70, max. 2 x 240 Min. 2 x 2/0, max. 2 x 500 kcmil	Max. 2 x (20 x 24 x 0.5) M12 (hexagon socket, A/F 5) 20 ... 22 (180 ... 195 lb.in)
Main conductors: <u>Without box terminal/busbar connection¹⁾</u>			
<ul style="list-style-type: none"> • Finely stranded with cable lug mm² • Stranded with cable lug mm² • AWG cables, solid or stranded AWG • Connecting bar (max. width) mm • Terminal screws - Tightening torque Nm 		50 ... 240 70 ... 240 2/0 ... 500 kcmil 25 M10 x 30 (A/F 17) 14 ... 24 (124 ... 210 lb.in)	
Auxiliary conductors:			
<ul style="list-style-type: none"> • Solid mm² • Finely stranded with end sleeve mm² • AWG cables, solid or stranded AWG • Terminal screws - Tightening torque Nm 		2 x (0.5 ... 1.5) ²⁾ , 2 x (0.75 ... 2.5) ²⁾ acc. to IEC 60947, max. 2 x (0.75 ... 4) 2 x (0.5 ... 1.5) ²⁾ ; 2 x (0.75 ... 2.5) ²⁾ 2 x (18 ... 14) M3 (PZ 3) 0.8 ... 1.2 (7 ... 10.3 lb.in)	

¹⁾ When connecting cable lugs to DIN 46234, the 3RT19 66-4EA1 terminal cover must be used for conductor cross-sections of 240 mm² and more as well as DIN 46235 for conductor cross-sections of 185 mm² and more to keep the phase clearance.

²⁾ If two different conductor cross-sections are connected to one clamping point, both cross-sections must lie in the range specified. If identical cross-sections are used, this restriction does not apply.

3RT, 3RH, 3TB, 3TC, 3TH, 3TK Contactors for Special Applications

3RT13 Contactors for Switching Resistive Loads (AC-1)

4-pole, 4 NO, 18 ... 140 A

Overview

AC and DC operation

EN 60947-4-1 (VDE 0660 Part 102).

The contactors are suitable for use in any climate. They are finger-safe according to EN 50274.

The accessories for the 3-pole SIRIUS contactors can also be used for the 4-pole versions.

Function

- Switching resistive loads
- Isolating systems with ungrounded or poorly grounded neutral conductors
- System transfers when alternative AC power supplies are used
- As contactors, e. g. for variable-speed operating mechanisms which only have to carry current and not switch
- The contactors are also suitable for switching mixed loads in distribution systems (e. g. for supplying heaters, lamps, motors, PC power supply units) with p.f. > 0.8 according to IEC 60947-4-1 test conditions for utilization category AC-1.

Integration

Mountable auxiliary contacts

Size S00

4 auxiliary contacts (according to EN 50005)

Size S0

Maximum 2 auxiliary contacts (either laterally mounted or snapped onto the top).

Size S2 to S3

Max. 4 auxiliary contacts (either laterally mounted or snapped onto the top)

Contactor assembly with mechanical interlock

The 4-pole 3RT13 contactors with 4 NO contacts as the main contacts are suitable for making contactor assemblies with a mechanical interlock, e. g. for system transfers.

Size S00

Contactor assemblies can be constructed from two 3RT13 1. contactors in conjunction with mechanical interlocks and two connecting clips (Order No.: 3RA19 12-2H, pack with 10 interlock elements and 20 clips for 10 assemblies).

Size S0

When constructing 4-pole contactor assemblies from two 3RT13 2. contactors, the fourth pole of the left contactor must always be moved to the left side. The contactor assembly can then be made easily with the aid of the 3RA19 24-1A mechanical interlock fitted onto the front and the 3RA19 22-2C mechanical connectors. The laterally mountable 3RA19 24-2B mechanical interlock can be used if the contactor assembly is mounted on a base plate.

Sizes S2 and S3

Contactor assemblies can be constructed from two 3RT13 3. or two 3RT13 4. contactors in conjunction with the laterally mountable 3RA19 24-2B mechanical interlock and the 3RA19 .2-2G mechanical connectors. The mechanical interlock for fitting onto the front cannot be used for size S2 and S3 contactors.

3RT, 3RH, 3TB, 3TC, 3TH, 3TK Contactors for Special Applications

3RT13 Contactors for Switching Resistive Loads (AC-1)

4-pole, 4 NO, 18 ... 140 A

Technical specifications

Contactors	Type Size		3RT13 16 S00	3RT13 17	3RT13 25 S0	3RT13 26	3RT13 36 S2	3RT13 44 S3	3RT13 46 S3	
General data										
Permissible mounting position¹⁾										
Mechanical endurance		Operating cycles	30 million	10 million						
Electrical endurance at $I_e/AC-1$		Operating cycles	Approx. 0.5 million							
Rated insulation voltage U_i (degree of pollution 3)		V	690							
Permissible ambient temperature		• During operation • During storage	°C	-25 ... +60 -55 ... +80						
Degree of protection Acc. to EN 60947-1, Appendix C		Device Connection range	IP20				IP20 IP00			
Touch protection acc. to EN 50274		Finger-safe								
Short-circuit protection of contactors without overload relays										
Main circuit										
Fuse links, gL/gG operational class LV HRC, 3NA, DIAZED, 5SB, NEOZED, 5SE acc. to IEC 60947-4-1/ EN 60947-4-1		• Type of coordination *1* ¹⁾ • Type of coordination *2* ¹⁾ • Weld-free	A A A	35 20 10	63 25/35 16	160 63 50	250 125 63	250 160 100		
Control										
Magnetic coil operating range		AC at 50 Hz AC at 60 Hz DC at 50 °C DC at 60 °C AC/DC		0.8 ... 1.1 x U_s 0.85 ... 1.1 x U_s 0.8 ... 1.1 x U_s 0.85 ... 1.1 x U_s	0.8 ... 1.1 x U_s					
Power consumption of the magnetic coils (when coil is cold and 1.0 x U_s)										
• AC operation, 50 Hz		- Closing - P.f.	VA VA		61 0.82		145 0.79	270 0.68		
		- Closed - P.f.	VA VA		7.8 0.24		12.5 0.36	22 0.27		
• AC operation, 50/60 Hz		- Closing - P.f.	VA	26.5/24.3 0.79/0.75	64/63 0.82/0.74		170/155 0.76/0.72	298/274 0.72/0.62		
		- Closed - P.f.	VA	4.4/3.4 0.27/0.27	8.4/6.8 0.24/0.28		15/11.8 0.35/0.38	27/20 0.29/0.31		
• DC operation		- Closing = Closed	W	3.3	5.6		13.3	15		
Operating times for 0.8 ... 1.1 x U_s²⁾ Total break time = Opening delay + Arcing time										
• DC operation		- Closing delay - Opening delay	ms	25 ... 100 7 ... 10	30 ... 90 13 ... 40		50 ... 110 15 ... 30	110 ... 200 14 ... 20		
• AC operation		- Closing delay - Opening delay	ms	8 ... 35 4 ... 30	6 ... 30 13 ... 25		4 ... 35 10 ... 30	20 ... 50 10 ... 25		
• Arcing time			ms	10 ... 15	10 ... 15		10 ... 15	10 ... 15		
Main circuit										
AC capacity										
Utilization category AC-1, switching resistive loads										
• Rated operational currents I_e		At 40 °C, up to 690 V At 60 °C, up to 690 V	A A	18 16	22 20	35 30	40 35	60 55	110 100	140 120
• Rated power for AC loads P.f. = 0.95 (at 40 °C)		At 230 V 400 V	kW kW	7 12	8.5 14.5	12.5 22	15 26	23 39	42 72	53 92
• Minimum conductor cross-section for loads with I_e		At 40 °C At 60 °C	mm ² mm ²	2.5 2.5	2.5 2.5	10 10	10 10	16 16	50 50	50 50
Utilization category AC-2 and AC-3										
• Rated operational currents I_e		At 60 °C, up to 400 V	A	9	12	17	25	26	--	--
• Rated power of slipring or squirrel-cage motors at 50 Hz and 60 Hz		At 230 V 400 V	kW kW	3 4	3 5.5	4 7.5	5.5 11	5.5 11	--	--

¹⁾ In accordance with the corresponding 3-pole 3RT1 contactors.

²⁾ With size S00, DC operation: Operating times at 0.85 ... 1.1 x U_s .

3RT, 3RH, 3TB, 3TC, 3TH, 3TK Contactors for Special Applications

3RT13 Contactors for Switching Resistive Loads (AC-1)

4-pole, 4 NO, 18 ... 140 A

Contactor	Type Size	3RT13 16 S00	3RT13 17	3RT13 25 S0	3RT13 26
Main circuit					
<i>Load rating with DC</i>					
Utilization category DC-1, switching resistive loads ($L/R \leq 1$ ms)					
• Rated operational currents I_e (at 40 °C)					
- 1 conducting path	Up to 24 V A	18	22	35	
	60 V A	18	22	20	
	110 V A	2.1	2.1	4.5	
	220 V A	0.8	0.8	1	
	440 V A	0.6	0.6	0.4	
- 2 conducting paths in series	Up to 24 V A	18	22	35	
	60 V A	18	22	35	
	110 V A	12	12	35	
	220 V A	1.6	1.6	5	
	440 V A	0.8	0.8	1	
- 3 conducting paths in series	Up to 24 V A	18	22	35	
	60 V A	18	22	35	
	110 V A	18	22	35	
	220 V A	18	22	35	
	440 V A	1.3	1.3	2.9	
- 4 conducting paths in series	Up to 24 V A	18	22	35	
	60 V A	18	22	35	
	110 V A	18	22	35	
	220 V A	18	22	35	
	440 V A	1.3	1.3	2.9	
Utilization category DC-3/DC-5					
Shunt-wound and series-wound motors ($L/R \leq 15$ ms)					
• Rated operational currents I_e (at 40 °C)					
- 1 conducting path	Up to 24 V A	18	20	20	
	60 V A	0.5	0.5	5	
	110 V A	0.15	0.15	2.5	
	220 V A	--	--	1	
	440 V A	--	--	0.09	
- 2 conducting paths in series	Up to 24 V A	18	20	35	
	60 V A	5	5	35	
	110 V A	0.35	0.35	15	
	220 V A	--	--	3	
	440 V A	--	--	0.27	
- 3 conducting paths in series	Up to 24 V A	18	20	35	
	60 V A	18	20	35	
	110 V A	18	20	35	
	220 V A	1.5	1.5	10	
	440 V A	0.2	0.2	0.6	
- 4 conducting paths in series	Up to 24 V A	18	20	35	
	60 V A	18	20	35	
	110 V A	18	20	35	
	220 V A	1.5	1.5	35	
	440 V A	0.2	0.2	0.6	
Maximum breaking current AC					
e. g for isolation of load distributions					
• 50/60 Hz	400 V A	72	96	200	

3RT, 3RH, 3TB, 3TC, 3TH, 3TK Contactors for Special Applications

3RT13 Contactors for Switching Resistive Loads (AC-1)

4-pole, 4 NO, 18 ... 140 A

Contactors	Type Size	3RT13 36 S2	3RT13 44 S3	3RT13 46 S3
Main circuit				
<i>Load rating with DC</i>				
Utilization category DC-1, switching resistive loads ($L/R \leq 1$ ms)				
• Rated operational currents I_e (at 40 °C)				
- 1 conducting path	Up to 24 V A	50	70	80
	60 V A	23	23	60
	110 V A	4.5	4.5	9
	220 V A	1	1	2
	440 V A	0.4	0.4	0.6
- 2 conducting paths in series	Up to 24 V A	50	70	80
	60 V A	45	70	80
	110 V A	45	70	80
	220 V A	5	5	10
	440 V A	1	1	1.8
- 3 conducting paths in series	Up to 24 V A	50	70	80
	60 V A	45	70	80
	110 V A	45	70	80
	220 V A	45	70	80
	440 V A	2.9	2.9	4.5
- 4 conducting paths in series	Up to 24 V A	50	70	80
	60 V A	45	70	80
	110 V A	45	70	80
	220 V A	45	70	80
	440 V A	2.9	2.9	4.5
Utilization category DC-3/DC-5				
Shunt-wound and series-wound motors ($L/R \leq 15$ ms)				
• Rated operational currents I_e (at 40 °C)				
- 1 conducting path	Up to 24 V A	20	20	20
	60 V A	6	6	6.5
	110 V A	2.5	2.5	2.5
	220 V A	1	1	1
	440 V A	0.1	0.15	0.15
- 2 conducting paths in series	Up to 24 V A	45	70	80
	60 V A	45	70	80
	110 V A	25	70	80
	220 V A	5	7	7
	440 V A	0.27	0.42	0.42
- 3 conducting paths in series	Up to 24 V A	45	70	80
	60 V A	45	70	80
	110 V A	45	70	80
	220 V A	25	35	35
	440 V A	0.6	0.8	0.8
- 4 conducting paths in series	Up to 24 V A	45	70	80
	60 V A	45	70	80
	110 V A	45	70	80
	220 V A	45	70	80
	440 V A	0.6	0.8	0.8
Maximum breaking current AC				
e. g for isolation of load distributions				
• 50/60 Hz	400 V A	400	520	760

3RT, 3RH, 3TB, 3TC, 3TH, 3TK Contactors for Special Applications

3TK1 Contactors for Switching Resistive Loads (AC-1)

4-pole, 4 NO, 200 ... 1000 A

Overview

EN 60947-4-1 (VDE 0660 Part 102)

The contactors also comply with the requirements of NFC 63-110 and NFC 20-040.

The contactors are suitable for use in any climate. They are finger-safe according to EN 50274. Terminal covers may have to be fitted onto the connecting bars, depending on the configuration with other devices.

Magnetic coils for 3TK10 to 3TK13 contactors: as withdrawable coils.

Surge suppression

Control circuit

Magnetic coils for 3TK1 contactors: can be retrofitted with RC elements.

Function

- Isolating systems with ungrounded or poorly grounded neutral conductors
- Switching resistive loads
- System transfers when alternative AC power supplies are used
- The contactors are also suitable for switching mixed loads in distribution systems (e. g for supplying heaters, lamps, motors, PC networks) with p.f. > 0.8 according to IEC 60947-4-1 test conditions for utilization category AC-1

Technical specifications

Contactors	Type	3TK1	
Rated data of the auxiliary contacts		Acc. to IEC 60947-5-1 (VDE 0660 Part 200)	
Rated insulation voltage U_i (degree of pollution 3)	V	690	
Continuous thermal current I_{th} = Rated operational current $I_e/AC-12$	A	10	
AC load			
Rated operational current $I_e/AC-15/AC-14$			
• For rated operational voltage U_e			
	24 V	A	6
	110 V	A	6
	125 V	A	6
	220 V	A	6
	230 V	A	6
	380 V	A	4
	400 V	A	4
	500 V	A	1
	660 V	A	1
	690 V	A	1
DC load			
Rated operational current $I_e/DC-12$			
• For rated operational voltage U_e			
	24 V	A	--
	60 V	A	--
	110 V	A	--
	125 V	A	--
	220 V	A	--
	440 V	A	--
	600 V	A	--
Rated operational current $I_e/DC-13$			
• For rated operational voltage U_e			
	24 V	A	6
	60 V	A	6
	110 V	A	1.8
	125 V	A	--
	220 V	A	0.6
	440 V	A	--
	600 V	A	--
Ⓢ and Ⓣ ratings of the auxiliary contacts			
Rated voltage	V AC, max.	600	
Switching capacity		A 600, P 600	

3RT, 3RH, 3TB, 3TC, 3TH, 3TK Contactors for Special Applications

3TK1 Contactors for Switching Resistive Loads (AC-1)

4-pole, 4 NO, 200 ... 1000 A

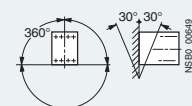
Contactor	Type		3TK10	3TK11	3TK12	3TK13	3TK14	3TK15	3TK17
General data									
Permissible mounting position Vertical mounting position also permitted.									
Mechanical endurance	Operating cycles	Mill.	10				5		
Electrical endurance for I_e /AC-1 at 55 °C	Operating cycles	Mill.	0.8	0.8	0.8	0.4	0.65	0.5	0.4
Rated insulation voltage U_i (degree of pollution 3)		V	1000						
Ambient temperature	• During operation • During storage	°C	-25 ... +55 -50 ... +70						
Degree of protection acc. to EN 60947-1, Appendix C			IP00						
Touch protection acc. to EN 50274			Finger-safe with cover						
Shock resistance	Sine pulse	g/ms	10/15						
Short-circuit protection									
Main circuit Fuse links, gL/gG, LV HRC 3NA, DIAZED 5SB, NEOZED 5SE acc. to IEC 60947-4-1/ EN 60947-4-1									
	• Type of coordination *1*: • Type of coordination *2*:	A	250		355		800	1000	
		A	250		315		630	850	
Auxiliary circuit (short-circuit current $I_{sc} \geq 1$ kA) fuse links, gL/gG, DIAZED 5SB, NEOZED 5SE		A	10						
Control									
Magnetic coil operating range			0.85 ... 1.1 x U_s						
Power consumption of the magnetic coils (when coil is cold and 1.0 x U_s)									
• 50 Hz	- Closing - P.f.	VA	820 0.4		1100 0.35		3500 0.26		
	- Closed - P.f.	VA	44 0.34		52 0.35		125 0.4		
• 60 Hz	- Closing - P.f.	VA	990 0.35		1200 0.31		4000 0.22		
	- Closed - P.f.	VA	52 0.35		65 0.34		140 0.43		
Operating times at 1.0 x U_s									
	- Closing delay	ms	20 ... 40				30 ... 60		
	- Opening delay	ms	7 ... 15				10 ... 20		
• Arcing time		ms	10				10		
Main circuit									
AC capacity									
Utilization category AC-1, switching resistive loads									
• Rated operational currents I_e	At 40° C up to 690 V	A	200	250	300	350	550	800	1000
	At 50° C up to 690 V	A	180	230	270	310	470	650	850
• Rated power for AC loads, p.f. = 0.95 (at 40°C)	At 230 V	kW	76	95	114	132	208	303	378
	400 V	kW	132	165	197	230	362	527	658
	500 V	kW	165	206	247	288	452	658	828
	690 V	kW	227	284	341	397	624	908	1135
• Minimum conductor cross-sections for loads with I_e	At 40° C	mm ²	95	150	185	240	185	240	300
Utilization category AC-2 and AC-3									
• Rated operational currents I_e	Up to 400 V	A	120	145	210	210	400	550	700
• Rated power of squirrel-cage or slipping motors at 50 Hz and 60 Hz	At 230 V	kW	30	45	75	75	110	160	220
	400 V	kW	55	75	110	110	200	280	370
• Short-time current at 40° C in cold state up to 10 s		A	900	1200	1600	1600	5300	5300	6400
Switching frequency¹⁾									
Switching frequency z in operating cycles/hour									
• Contactors without overload relays	- No-load switching frequency	1/h	3600						
	- AC-1	1/h	300						
	- AC-3	1/h	300						

¹⁾ Dependence of the switching frequency z' on the operational current I' and operational voltage U' : $z' = z \cdot (I_e/I') \cdot (400 V/U')^{1.5} \cdot 1/h$.

3RT, 3RH, 3TB, 3TC, 3TH, 3TK Contactors for Special Applications

3TK1 Contactors for Switching Resistive Loads (AC-1)

4-pole, 4 NO, 200 ... 1000 A

Contactor	Type		3TK10	3TK11	3TK12	3TK13	3TK14	3TK15	3TK17
Conductor cross-sections									
Main conductors:			Screw terminals						
• Stranded with cable lug		mm ²	2 x 70	2 x 120	2 x 120		2 x 300		
• Solid or stranded	AWG	MCM	2 x 00	2 x 250	2 x 250		2 x 600		
• Connecting bar (max. width)		mm	30	30	33		55		
• Terminal screw			M6	M10	M10		M10		
- Tightening torque		Nm	5	16	16		16		
		lb.in	42	135	135		135		
Auxiliary conductors:									
• Solid		mm ²	2 x (0.5 ... 2.5)						
• Finely stranded with end sleeve		mm ²	2 x (0.5 ... 2.5)						
• Solid or stranded	AWG	MCM	20 ... 14						
- Tightening torque		Nm	1.2 (10 lb.in)						

Overview

AC and DC operation

IEC 60947 (VDE 0660).

The contactors are suitable for use in any climate. The contactors with screw terminals are finger-safe according to EN 50274.

The contactors are available in versions with screw terminals, 6.3 mm plug-in terminals and solder pin connections for soldering in printed circuit boards.

Design

Auxiliary contacts

Contact reliability

To switch voltages ≤ 110 V and currents ≤ 100 mA the 3TH2 contactor relays should be used as they guarantee a high level of contact reliability.

These auxiliary contacts are suitable for solid-state circuits with currents ≥ 1 mA at a voltage of 17 V and higher.

Short-circuit protection of the contactors

For short-circuit protection of the contactors without overload relays see "Technical specifications".

Version

The 3TK2 contactors with 4 main contacts are available with screw terminals, 6.3 mm x 0.8 mm flat connectors and solder pin connectors.

The 3TK2 contactors with 6.3 mm x 0.8 mm flat connectors are coded can be used in the plug-in base with solder pin connections for printed circuit boards.

Technical specifications

3TK20

Endurance of the main contacts

The characteristic curves show the contact endurance of the contactors when switching inductive AC loads (AC-3) depending on the breaking current and rated operational voltage. It is assumed that the operating mechanisms are switched randomly, i. e. not synchronized with the phase angle of the supply system.

The rated operational current I_e complies with utilization category AC-4 (breaking six times the rated operational current) and is intended for a contact endurance of at least 200 000 operating cycles. If a shorter endurance is sufficient, the rated operational current $I_e/AC-4$ can be increased.

If the contacts are used for mixed operation, i. e. normal switching (breaking the rated operational current according to utilization category AC-3) in combination with intermittent inching (breaking several times the rated operational current according to utilization category AC-4), the contact endurance can be calculated approximately from the following equation:

$$X = \frac{A}{1 + \frac{C}{100} \left(\frac{A}{B} - 1 \right)}$$

Characters in the equation:

X = Contact endurance for mixed operation in operating cycles

A = Contact endurance for normal operation ($I_a = I_e$) in operating cycles

B = Contact endurance for inching ($I_a =$ multiple of I_e) in operating cycles

C = Inching operations as a percentage of total switching operations

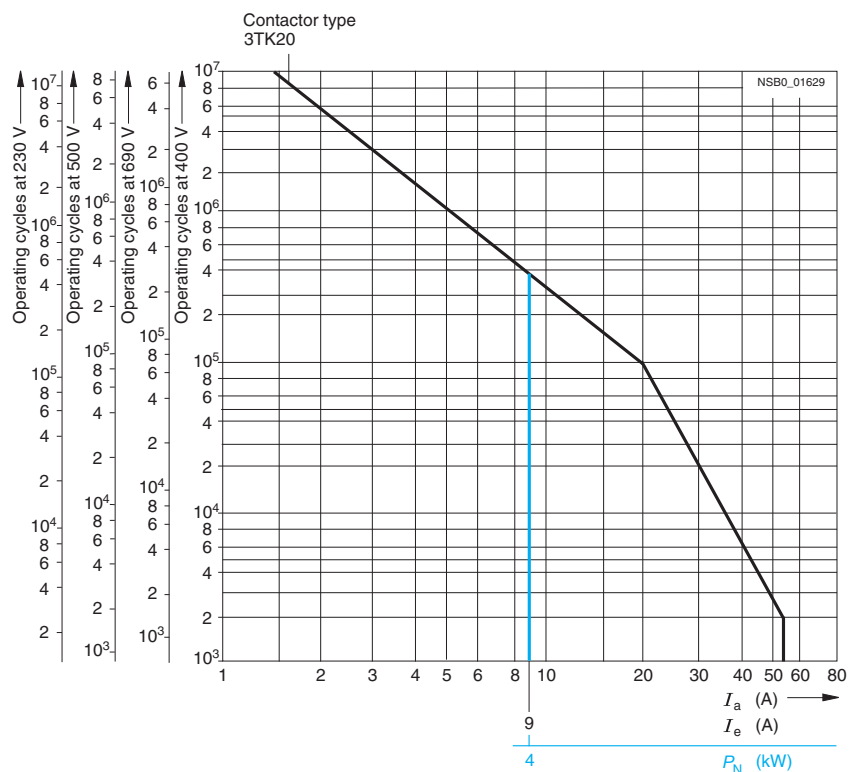

3RT, 3RH, 3TB, 3TC, 3TH, 3TK Contactors for Special Applications

3TK20 Contactors

4-pole, 4 kW

Contactors		3TK20	
Type		3TK20	
General data			
Permissible mounting position	AC and DC operation	Any	
Mechanical endurance	<ul style="list-style-type: none"> • AC operation • DC operation • Auxiliary switch block 	Operating cycles	10 million 30 million 10 million
Rated insulation voltage U_i (degree of pollution 3)			
• Screw terminals	V	690	
• Flat connector 6.3 mm x 0.8 mm	V	500	
• Solder pin connections	V	500	
Rated impulse withstand voltage U_{imp} (degree of pollution 3)			
• Screw terminals	kV	8	
• Flat connector 6.3 mm x 0.8 mm	kV	6	
• Solder pin connections	kV	6	
Protective separation between coil and main contacts (acc. to EN 61140)	V	Up to 300	
Permissible ambient temperature ¹⁾	<ul style="list-style-type: none"> • During operation • During storage 	°C	-25 ... +55 -55 ... +80
Degree of protection acc. to EN 60947-1 Appendix C			IP00 open IP20 for screw terminals IP40 coil assembly
Touch protection	Finger-safe for screw terminals		
Shock resistance			
• Rectangular pulse	<ul style="list-style-type: none"> - AC operation - DC operation 	g/ms	8.3/5 and 5.2/10 11.3/5 and 9.2/10
• Sine pulse	<ul style="list-style-type: none"> - AC operation - DC operation 	g/ms	13/5 and 8/10 17.4/5 and 12.9/10
Conductor cross-sections			
Short-circuit protection for contactors without overload relays			
Main circuit ³⁾			
• Fuse links gL/gG LV HRC 3NA, DIAZED 5SB, NEOZED 5SE acc. to IEC 60947-4-1 (VDE 0660, Part 102)	<ul style="list-style-type: none"> - Type of coordination "1" - Type of coordination "2"⁴⁾ - Weld-free 	A	25 10 10
• Miniature circuit breaker with C characteristic	A		10
Auxiliary circuit			
Short-circuit current $I_k \geq 1$ kA			
• Fuse links gL/gG DIAZED 5SB, NEOZED 5SE	A		6

1) Applies to 50/60 Hz coil:
At 50 Hz, $1.1 \times U_s$, side-by-side mounting and 100 % ON period the max. ambient temperature is +40 °C.

2) See page 3/114.

3) According to excerpt from IEC 60947-4-1 (VDE 0660 Part 102

Type of coordination "1"

Destruction of the contactor and the overload relay is permissible. The contactor and/or overload relay can be replaced if necessary.

Type of coordination "2":

The overload relay must not suffer any damage. Contact welding on the contactor is permissible, however, if the contacts can be easily separated.

4) A short-circuit current of $I_q \leq 6$ kA applies to type of coordination "2".

Contactors			
Type	3TK20		
Control			
Magnetic coil operating range¹⁾		0.8 ... 1.1 x U_s	
Power consumption of the magnetic coils (when coil is cold and 1.0 x U_s)			
Standard version:			
• AC operation, 50 Hz	Closing	VA	15
	P.f.		0.41
	Closed	VA	6.8
	P.f.		0.42
• AC operation, 60 Hz	Closing	VA	14.4
	P.f.		0.36
	Closed	VA	6.1
	P.f.		0.46
• AC operation, 50/60 Hz ¹⁾	Closing	VA	16.5/13.2
	P.f.		0.43/0.38
	Closed	VA	8.0/5.4
	P.f.		0.48/0.42
For USA and Canada:			
• AC operation, 50 Hz	Closing	VA	14.6
	P.f.		0.38
	Closed	VA	6.5
	P.f.		0.40
• AC operation, 60 Hz	Closing	VA	14.4
	P.f.		0.30
	Closed	VA	6.0
	P.f.		0.44
• DC operation	Closing = Closed	W	3
Permissible residual current of the electronic circuit²⁾ (for 0 signal)			
	• AC operation	mA	$\leq 3 \times (230 \text{ V}/U_s)$
	• DC operation	mA	$\leq 1 \times (230 \text{ V}/U_s)$
Operating times at 0.8 ... 1.1 x U_s³⁾			
Total break time = Opening delay + Arcing time			
Values apply with coil in cold state and at operating temperature for operating range			
• AC operation	Closing delay	ms	5 ... 19
	Opening delay	ms	2 ... 22
- Dead interval			To use the 3TK20 AC-operated contactor in reversing duty an additional dead interval of 50 ms is required along with an NC contact interlock.
• DC operation	Closing delay	ms	16 ... 65
	Opening delay	ms	2 ... 5
• Arcing time		ms	10 ... 15
Operating times at 1.0 x U_s³⁾			
• AC operation	Closing delay	ms	5 ... 18
	Opening delay	ms	3 ... 21
- Dead interval			To use the 3TK20 AC-operated contactor in reversing duty an additional dead interval of 50 ms is required along with an NC contact interlock.
• DC operation	Closing delay	ms	19 ... 31
	Opening delay	ms	3 ... 4
• Arcing time		ms	10 ... 15

¹⁾ Applies to 50/60 Hz coil:
At 50 Hz, 1.1 x U_s , side-by-side mounting and 100 % ON period the max. ambient temperature is +40 °C.

²⁾ The 3TX4 490-1J additional load module is recommended for higher residual currents (see Catalog LV 1).

³⁾ The OFF-delay of the NO contacts and ON-delay of the NC contacts increase if the contactor coils are protected against voltage peaks (noise suppression diode 6 to 10 times, diode assemblies 2 to 6 times, varistor +2 to 5 ms).

3RT, 3RH, 3TB, 3TC, 3TH, 3TK Contactors for Special Applications

3TK20 Contactors

4-pole, 4 kW

Contactors	Type	3TK20 ...0...	3TK20 ...3..., 3TK20 ...6..., 3TK20 ...7...
Size 00			
Main circuit			
AC capacity			
Utilization category AC-1, switching resistive loads			
• Rated operational current I_e (at 40 °C)	Up to 400/380 V A 690/660 V A	18 18	18 --
• Rated operational current I_e (at 55 °C)	400/380 V A 690/660 V A	16 16	16 --
• Rated power of AC loads P.f. = 1	At 230/220 V kW 400/380 V kW 500 V kW 690/660 V kW	6.0 10 13 17	6.0 10 13 --
• Minimum conductor cross-section for loads with I_e	mm ²	2.5	2.5
Utilization category AC-2 and AC-3			
• Rated operational current I_e	Up to 220 V A 230 V A 380 V A 400 V A 500 V A 660 V A 690 V A	9.0 9.0 9.0 8.4 6.5 5.2 5.2	9.0 9.0 9.0 8.4 6.5 -- --
• Rated power for motors with slipring or squirrel-cage rotors at 50 Hz and 60 Hz and	At 110 V kW 115 V kW 120 V kW 127 V kW 200 V kW 220 V kW 230 V kW 240 V kW 380 V kW 400 V kW 415 V kW 440 V kW 460 V kW 500 V kW 575 V kW 660 V kW 690 V kW	1.2 1.2 1.3 1.4 2.2 2.4 2.5 2.6 4.0 4.0 4.0 4.0 4.0 4.0 4.0 4.0 4.0	1.2 1.2 1.3 1.4 2.2 2.4 2.5 2.6 4.0 4.0 4.0 4.0 4.0 4.0 -- -- --
Utilization category AC-4			
(contact endurance approx. 200000 operating cycles at $I_a = 6 \times I_e$)			
• Rated operational current I_e	Up to 400 V A 690 V A	2.6 1.8	2.6 --
• Rated power for motors with squirrel-cage rotor at 50 and 60 Hz and	At 110 V kW 115 V kW 120 V kW	0.32 0.33 0.35	0.32 0.33 0.35
• Max. permissible rated operational current $I_e/AC-4 \cong I_e/AC-3$ up to 500 V, for reduced contact endurance and reduced switching frequency	127 V kW 200 V kW 220 V kW 230 V kW 240 V kW 380 V kW 400 V kW 415 V kW 440 V kW 460 V kW 500 V kW 575 V kW 660 V kW 690 V kW	0.37 0.58 0.64 0.67 0.70 1.10 1.15 1.20 1.27 1.33 1.45 1.30 1.10 1.15	0.37 0.58 0.64 0.67 0.70 1.10 1.15 1.20 1.27 1.33 1.45 -- -- --

Contactors	Type	3TK20 ...0...	3TK20 ...-3..., 3TK20 ...-6..., 3TK20 ...-7...
Size 00			
Main circuit			
AC capacity			
Utilization category AC-5a, switching gas discharge lamps			
Per main current path at 230/220 V			
• Rated power per lamp	Rated operational current per lamp (A)		
- Uncorrected			
L 18 W	0.37	Units 43	
L 36 W	0.43	Units 37	
L 58 W	0.67	Units 23	
- DUO switching			
L 18 W	0.11	Units 144	
L 36 W	0.21	Units 76	
L 58 W	0.32	Units 50	
Switching gas discharge lamps with correction, solid-state ballast			
Per main current path at 230/220 V			
• Rated power per lamp	Capacitance (µF)	Rated operational current per lamp (A)	
- Parallel correction			
L 18 W	4.5	0.11	Units 22
L 36 W	4.5	0.21	Units 22
L 58 W	7	0.31	Units 14
- With solid-state ballast (single lamp)			
L 18 W	6.8	0.10	Units 63
L 36 W	6.8	0.18	Units 35
L 58 W	10	0.27	Units 23
- With solid-state ballast (two lamps)			
L 18 W	10	0.18	Units 35
L 36 W	10	0.35	Units 18
L 58 W	22	0.52	Units 12
Utilization category AC-5b, switching incandescent lamps		kW	1.6
Per main current path at 230/220 V			--
Utilization category AC-6a, switching AC transformers			
• Rated operational current I_e			
- For inrush current $n = 20$	At 400 V	A	5.1
- For inrush current $n = 30$	At 400 V	A	3.3
• Rated power P			
- For inrush current $n = 20$	Up to 230/220 V	kVA	2.0
	400/380 V	kVA	3.5
	500 V	kVA	4.6
	690/660 V	kVA	6.0
- For inrush current $n = 30$	Up to 230/220 V	kVA	1.3
	400/380 V	kVA	2.3
	500 V	kVA	3.1
	690/660 V	kVA	4.0
For deviating inrush current factors x , the power must be recalculated as follows: $P_x = P_{n30} \times (30/x)$			
Utilization category AC-6b, switching low-inductance (low-loss, metallized dielectric) AC capacitors		No switching capacity	
Utilization category AC-7a, switching low inductive loads in household appliances			
• Rated operational current I_e (at 55 °C)	At 400/380 V	A	16
	690/660 V	A	16
• Rated power at 50 and 60 Hz	At 230/220 V	kW	6
	400/380 V	kW	10
• Minimum conductor cross-section for loads with I_e		mm ²	2.5
Utilization category AC-7b, switching motor loads in household appliances			
• Rated operational current I_e	Up to 220 V	A	9.0
	230 V	A	9.0
	380 V	A	9.0
	400 V	A	8.4
• Rated power of motors at 50 and 60 Hz and	At 110 V	kW	1.2
	220 V	kW	2.4
	230 V	kW	2.5
	240 V	kW	2.6
	380 V	kW	4.0
	400 V	kW	4.0

3RT, 3RH, 3TB, 3TC, 3TH, 3TK Contactors for Special Applications

3TK20 Contactors

4-pole, 4 kW

Contactors	Type	3TK20 ...0...	3TK20 ...3..., 3TK20 ...6..., 3TK20 ...7...
Size 00			
Main circuit			
<i>Load rating with DC</i>			
Utilization category DC-1, switching resistive loads (contact endurance 0.1×10^9 operating cycles; $L/R \leq 1$ ms)			
• Rated operational current I_{θ} (at 55 °C)			
- 1 conducting path	Up to 24 V A 60 V A 110 V A 220/240 V A	16 6 2 1	16 6 2 1
- 2 conducting paths in series	Up to 24 V A 60 V A 110 V A 220/240 V A	16 16 6 2	16 16 6 2
- 3 conducting paths in series	Up to 24 V A 60 V A 110 V A 220/240 V A	16 16 16 6	16 16 16 6
Utilization category DC-3 and DC-5, shunt-wound and series-wound motors ($L/R \leq 15$ ms)			
• Rated operational current I_{θ} (at 55 °C)			
- 1 conducting path	Up to 24 V A 60 V A 110 V A 220/240 V A	6 3 0.5 0.1	6 3 0.5 0.1
- 2 conducting paths in series	Up to 24 V A 60 V A 110 V A 220/240 V A	10 5 2 0.5	10 5 2 0.5
- 3 conducting paths in series	Up to 24 V A 60 V A 110 V A 220/240 V A	16 16 16 2	16 16 16 2
Thermal load capacity		10 s current A	70
Power loss per conducting path		At $I_{\theta}/AC-3$ W	0.3
<i>Switching frequency</i>			
Switching frequency z in operating cycles/hour			
• Contactors without overload relays	No-load switching frequency	h^{-1}	10000
Dependence of the switching frequency z' on the operational current I' and operational voltage U': $z' = z \cdot (I_{\theta}/I') \cdot (400 V/U')^{1.5} \cdot 1/h$	AC-1	h^{-1}	1000
	AC-2	h^{-1}	500
	AC-3	h^{-1}	1000
• Contactors with overload relays (mean value)		h^{-1}	15
Conductor cross-sections			
Main and auxiliary conductors			
• Solid		mm ²	2 x (0.5 ... 2.5), 1 x 4 2 x (20 ... 14) AWG, 1 x 12 AWG
• Finely stranded with end sleeve		mm ²	2 x (0.5 ... 1.5), 1 x 2.5
• Pin-end connector (DIN 46231)		mm ²	1 x 1 ... 2.5
• Terminal screw			M3
• Prescribed tightening torque for terminal screws		Nm lb.in	0.8 ... 1.3 7 ... 11
Flat connectors			
• When using a plug-in sleeve	6.3 ... 1	mm ²	0.5 ... 1
• Finely stranded	6.3 ... 2.5	mm ²	1 ... 2.5
Solder pin connections (only for printed circuit boards)			

3RT, 3RH, 3TB, 3TC, 3TH, 3TK Contactors for Special Applications

3TK20 Contactors

4-pole, 4 kW

Contactors	Type		3TK20 ...-0...	3TK20 ...-3..., 3TK20 ...-6..., 3TK20 ...-7...
Size 00				
Ⓢ and Ⓣ rated data of the 3TK20 contactors				
Rated insulation voltage U_i		V AC	600	300
Uninterrupted current	• Open and enclosed	A	16	16 (10 for solder pin connection)
Maximum horsepower ratings (Ⓢ and Ⓣ approved values)				
• Rated power for induction motors at 60 Hz				
- 1-phase		At 115 V hp	0.5	--
		200 V hp	1	1
		230 V hp	1.5	1
		460/575 V hp	--	--
- 3-phase		At 115 V hp	--	--
		200 V hp	3	3 (1 for 3TK20 ...-6)
		230 V hp	3	3 (1 for 3TK20 ...-6)
		460/575 V hp	5	--
Overload relay	Type/Setting range		3UA7/EB 8 ... 10 A	

Contactors	Type		3TK20	
Size 00				
Rated data of the auxiliary contacts acc. to IEC 60947-5-1 (VDE 0660 Part 200)				
Rated insulation voltage U_i (degree of pollution 3)		V	690	
Continuous thermal current I_{th} = Rated operational current $I_e/AC-12$		A	10	
AC load				
Rated operational current $I_e/AC-15/AC-14$				
• For rated operational voltage U_e		24 V A	4	
		110 V A	4	
		125 V A	4	
		220 V A	4	
		230 V A	4	
		380 V A	3	
		400 V A	3	
		500 V A	2	
		660 V A	1	
		690 V A	1	
DC load				
Rated operational current $I_e/DC-12$				
• For rated operational voltage U_e		24 V A	4	
		48 V A	2.2	
		110 V A	1.1	
		125 V A	1.1	
		220 V A	0.5	
		440 V A	--	
		600 V A	--	
Rated operational current $I_e/DC-13$				
• For rated operational voltage U_e		24 V A	2.1	
		48 V A	1.1	
		110 V A	0.52	
		125 V A	0.52	
		220 V A	0.27	
		440 V A	--	
		600 V A	--	
Ⓢ, Ⓣ and Ⓜ rated data of the auxiliary contacts				
Rated voltage, max.		V AC	600	
Auxiliary switch blocks, max.		V AC	300	
Switching capacity				
Uninterrupted current at 240 V AC		A	10	

3RT, 3RH, 3TB, 3TC, 3TH, 3TK Contactors for Special Applications

3RT15 Contactors

4-pole, 2 NO + 2 NC, 4 ... 18.5 kW

Overview

AC and DC operation

EN 60947-4-1 (VDE 0660 Part 102).

The contactors are suitable for use in any climate. They are finger-safe according to EN 50274.

The accessories for the 3-pole SIRIUS contactors can also be used for the 4-pole versions.

Function

- Changing the polarity of hoisting gear motors
- Switching two separate loads

Note:

Single device for pole reversal; not suitable for reversing duty. 3RT15 contactors are not suitable for switching a load between two current sources.

Integration

Mountable auxiliary contacts

Size S00

4 auxiliary contacts (auxiliary switch blocks according to EN 50005)

Size S0

Maximum 2 auxiliary contacts (either laterally mounted or snapped onto the top auxiliary switch blocks according to EN 50012 and EN 50005).

Size S2

Maximum 4 auxiliary contacts (either laterally mounted or snapped onto the top auxiliary switch blocks to EN 50012 and EN 50005).

Technical specifications

Contactors	Type Size	3RT15 16 S00	3RT15 17 S00	3RT15 26 S0	3RT15 35 S2
General data					
Permissible mounting position¹⁾					
Mechanical endurance		Operating cycles	30 million	10 million	
Electrical endurance at $I_e/AC-1$		Operating cycles	Approx. 0.5 million		
Rated insulation voltage U_i (degree of pollution 3)		V	690		
Permissible ambient temperature		• During operation • During storage	°C -25 ... +60 °C -55 ... +80		
Degree of protection acc. to EN 60947-1, Appendix C			IP20	IP20 (IP00 terminal compartment)	
Touch protection acc. to EN 50274			Finger-safe		
Short-circuit protection of contactors without overload relays					
Main circuit					
Fuse links, gL/gG	• Type of coordination "1"	A	35	63	160
LV HRC 3NA, DIAZED 5SB, NEOZED 5SE	• Type of coordination "2"	A	20	35	80
Acc. to IEC 60947-4-1/ EN 60947-4-1	• Weld-free	A	10	16	50
Control					
Magnetic coil operating range		AC at 50 Hz AC at 60 Hz DC at 50 °C DC at 60 °C AC/DC	0.8 ... 1.1 x U_s 0.85 ... 1.1 x U_s 0.8 ... 1.1 x U_s 0.85 ... 1.1 x U_s		0.8 ... 1.1 x U_s
Power consumption of the magnetic coils (when coil is cold and 1.0 x U_s)					
• AC operation, 50 Hz	- Closing	VA		61	145
	- P.f.	VA		0.82	0.79
• AC operation, 50/60 Hz	- Closing	VA	26.5/24.3	64/63	170/155
	- P.f.	VA	0.79/0.75	0.82/0.74	0.76/0.72
• DC operation	- Closing	VA	4.4/3.4	8.4/6.8	15/11.8
	- P.f.	VA	0.27/0.27	0.24/0.28	0.35/0.38
	- Closing = Closed	W	3.3	5.6	13.3
Operating times for 0.8 ... 1.1 x U_s²⁾ Total break time = Opening delay + Arcing time					
AC/DC operation					
• DC operation	- Closing delay	ms	25 ... 100	30 ... 90	50 ... 110
	- Opening delay	ms	7 ... 10	13 ... 40	15 ... 30
• AC operation	- Closing delay	ms	8 ... 35	6 ... 30	4 ... 35
	- Opening delay	ms	4 ... 30	13 ... 25	10 ... 30
• Arcing time		ms	10 ... 15		

1) In accordance with the corresponding 3-pole 3RT1 contactors.

2) With size S00, DC operation: operating times at 0.85 ... 1.1 x U_s .

3RT, 3RH, 3TB, 3TC, 3TH, 3TK Contactors for Special Applications

3RT15 Contactors

4-pole, 2 NO + 2 NC, 4 ... 18.5 kW

Contactors	Type Size	3RT15 16 S00	3RT15 17 S00	3RT15 26 S0	3RT15 35 S2
Main circuit					
AC capacity					
Utilization category AC-1, switching resistive loads					
• Rated operational currents I_e	At 40 °C up to 690 V A	18	22	40	60
	At 60 °C up to 690 V A	16	20	35	55
• Rated power for AC loads P.f. = 0.95 (at 60 °C)	At 230 V kW	6.5	7.5	15	20
	400 V kW	11	13	26	36
• Minimum conductor cross-section for loads with I_e	At 40 °C mm ²	2.5	2.5	10	16
Utilization category AC-2 and AC-3					
• Rated operational currents I_e (at 60 °C)	Up to 400 V A	9	12	25 ¹⁾	40
	At 230 V kW	3	3	5.5	9.5
• Rated power of slipping or squirrel-cage motors at 50 and 60 Hz	400 V kW	4	5.5	11	18.5
Load rating with DC					
Utilization category DC-1, switching resistive load ($L/R \leq 1$ ms)					
• Rated operational currents I_e (at 60 °C)					
- 1 conducting path	Up to 24 V A	16	20	35	50
	60 V A	16	20	20	23
	110 V A	2.1	2.1	4.5	4.5
	220 V A	0.8	0.8	1	1
	440 V A	0.6	0.6	0.4	0.4
- 2 conducting paths in series	Up to 24 V A	16	20	35	50
	60 V A	16	20	35	45
	110 V A	12	12	35	45
	220 V A	1.6	1.6	5	5
	440 V A	0.8	0.8	1	1
Utilization category DC-3/DC-5²⁾, shunt-wound and series-wound motors ($L/R \leq 15$ ms)					
• Rated operational currents I_e (at 60 °C)					
- 1 conducting path	Up to 24 V A	16	20	20	35
	60 V A	0.5	0.5	5	6
	110 V A	0.15	0.15	2.5	2.5
	220 V A	0.75	0.75	1	1
	440 V A	--	--	0.09	0.1
- 2 conducting paths in series	Up to 24 V A	16	20	35	50
	60 V A	5	5	35	45
	110 V A	0.35	0.35	15	25
	220 V A	--	--	3	5
	440 V A	--	--	0.27	0.27

¹⁾ For AC operation: 25 A
DC operation: 20 A.

²⁾ For $U_s > 24$ V the rated operational currents I_e for the NC contact conducting paths are 50 % of the values for the NO contact conducting paths.

3RT, 3RH, 3TB, 3TC, 3TH, 3TK Contactors for Special Applications

3RT16 Capacitor Contactors

12.5 ... 50 kvar

Overview

AC operation

IEC 60947, EN 60947 (VDE 0660)

The contactors are suitable for use in any climate. They are finger-safe according to EN 50274.

The 3RT16 capacitor contactors are special version of the size S00 to S3 SIRIUS contactors. The capacitors are precharged by means of the mounted leading NO contacts and resistors; only then do the main contacts close.

This prevents disturbances in the network and welding of the contactors.

Only discharged capacitors are permitted to be switched on with capacitor contactors.

The auxiliary switch block which is snapped onto the capacitor contactor contains the three leading NO contacts and in the case of S00 one standard NC contact and in the case of S0 and S3 one standard NO contact, which is unassigned. Size S00 also contains another unassigned NO contact in the basic unit.

In addition, a 2-pole auxiliary switch block can be mounted laterally on the 3RT16 47 capacitor contactors (2 NO, 2 NC or 1 NO + 1 NC versions); Type 3RH19 21-1EA... The fitting of auxiliary switches for 3RT16 17 and 3RT16 27 is not expandable.

For the capacitor switching capacity of the basic 3RT10 contactor version, see "Technical specifications".

Technical specifications

All technical specifications not mentioned in the table below are identical to those of the 3RT10 17 contactors for size S00, to those of the 3RT10 26 contactors for size S0 and to those of the 3RT10 45 contactors for size S3.



Contactor	Type Size		3RT16 17-.A..3 S00	3RT16 27-.A..1 S0	3RT16 47-.A..1 S3
Capacitor rating at rated power (utilization category AC-6b)		230 V, 50/60 Hz kvar	3 ... 7.5	3.5 ... 15	3.5 ... 30
		400 V, 50/60 Hz kvar	5 ... 12.5	6 ... 25	5 ... 50
		525 V, 50/60 Hz kvar	7.5 ... 15	7.8 ... 30	7.5 ... 60
		690 V, 50/60 Hz kvar	10 ... 21	10 ... 42	10 ... 84
Auxiliary contacts mounted (unassigned)			1 NO + 1 NC	1 NO contact	
Auxiliary contacts mountable (lateral), not for sizes S00 and S0			--		2 NC + 2 NO or 1 NO + 1 NC
Magnetic coil operating range			0.8 ... 1.1 x U_s		
Max. switching frequency		h^{-1}	180	100	
Electrical endurance		Operating cycles	> 250000	> 150000	> 100000
Ambient temperature		°C	60		
Standards			IEC 60947/EN 60947 (VDE 0660)		
Short-circuit protection			1.6 ... 2.2 x I_e		
Conductor cross-sections (1 or 2 conductors connectable)					
Main conductor			Screw terminals		
• Solid	mm ²	2 x (0.5 ... 1.5); 2 x (0.75 ... 2.5) Acc. to IEC 60947; Max. 2 x (1 ... 4)	2 x (1 ... 2.5); 2 x (2.5 ... 6) Acc. to IEC 60947; Max. 1 x 10 ¹⁾	--	
• Finely stranded with end sleeve	mm ²	2 x (0.5 ... 1.5); 2 x (0.75 ... 2.5)	2 x (1 ... 2.5); 2 x (2.5 ... 6) ¹⁾	--	
• AWG cables					
- Solid	AWG	2 x (20 ... 16)	2 x (16 ... 12)	--	
- Solid or stranded	AWG	2 x (18 ... 14)	2 x (14 ... 10)	--	
- Stranded	AWG	1 x 12	1 x 8	--	
• Terminal screws		M3	M4 (Pozidriv size 2)	--	
- Tightening torque	Nm	0.8 ... 1.2	2 ... 2.5	--	
	lb.in	7 ... 10.3	18 ... 22	--	

1) 3RV19 25-5AB feeder terminal for 16 mm².

3RT, 3RH, 3TB, 3TC, 3TH, 3TK Contactors for Special Applications

3RT16 Capacitor Contactors

12.5 ... 50 kvar

Contactors	Type Size	3RT16 17-.A..3 S00	3RT16 27-.A..1 S0	3RT16 47-.A..1 S3
Conductor cross-sections (1 or 2 conductors connectable)				
		⊕ Screw terminals		
Front clamping point connected 	Main conductors: With box terminal			
	• Finely stranded with end sleeve	mm ²	--	2.5 ... 35
	• Finely stranded without end sleeve	mm ²	--	4 ... 50
	• Solid	mm ²	--	2.5 ... 16
	• Stranded	mm ²	--	4 ... 70
• Ribbon cable conductors (number x width x thickness)	mm	--	6 x 9 x 0.8	
• AWG cables, solid or stranded	AWG	--	10 ... 2/0	
Rear clamping point connected 	• Finely stranded with end sleeve	mm ²	--	2.5 ... 50
	• Finely stranded without end sleeve	mm ²	--	10 ... 50
	• Solid	mm ²	--	2.5 ... 16
	• Stranded	mm ²	--	10 ... 70
	• Ribbon cable conductors (number x width x thickness)	mm	--	6 x 9 x 0.8
• AWG cables, solid or stranded	AWG	--	10 ... 2/0	
Both clamping points connected 	• Finely stranded with end sleeve	mm ²	--	Max. 2 x 35
	• Finely stranded without end sleeve	mm ²	--	Max. 2 x 35
	• Solid	mm ²	--	Max. 2 x 16
	• Stranded	mm ²	--	Max. 2 x 50
	• Ribbon cable conductors (number x width x thickness)	mm	--	2 x (6 x 9 x 0.8)
• AWG cables, solid or stranded	AWG	--	2 x (10 ... 1/0)	
• Terminal screw - Tightening torque	Nm lb.in	-- --	-- --	M6 (hex. socket, A/F 4) 4 ... 6 36 ... 53
Connection for drilled copper bars ¹⁾	Max. width	mm	--	10
Without box terminal with cable lugs ²⁾ (1 or 2 conductors can be connected)	• Finely stranded with cable lug	mm ²	--	10 ... 50 ³⁾
	• Stranded with cable lug	mm ²	--	10 ... 70 ³⁾
	• AWG cables, solid or stranded	AWG	--	7 ... 1/0
Auxiliary conductors:				
• Solid	mm ²	2 x (0.5 ... 1.5) ⁴⁾ ; 2 x (0.75 ... 2.5) ⁴⁾ acc. to IEC 60947; max. 2 x (1 ... 4)	2 x (0.5 ... 1.5) ⁴⁾ ; 2 x (0.75 ... 2.5) ⁴⁾ acc. to IEC 60947; max. 2 x (0.75 ... 4)	
• Finely stranded with end sleeve	mm ²	2 x (0.5 ... 1.5) ⁴⁾ ; 2 x (0.75 ... 2.5) ⁴⁾		
• AWG cables, solid or stranded	AWG	2 x (20 ... 16) ⁴⁾ ; 2 x (18 ... 14) ⁴⁾ ; 1 x 12		
• Terminal screw - Tightening torque	Nm lb.in	M3 0.8 ... 1.2 7 ... 10.3		

¹⁾ If bars larger than 12 x 10 mm are connected, a 3RT19 46-4EA1 terminal cover is needed to comply with the phase clearance.

²⁾ When connecting conductors which are larger than 25 mm², the 3RT19 46-4EA1 terminal cover must be used to keep the phase clearance.

³⁾ Only with crimped cable lugs according to DIN 46234. Cable lug max. 20 mm wide.

⁴⁾ If two different conductor cross-sections are connected to one clamping point, both cross-sections must lie in the range specified. If identical cross-sections are used, this restriction does not apply.

3RT, 3RH, 3TB, 3TC, 3TH, 3TK Contactors for Special Applications

Contactors with Extended Operating Range $0.7 \dots 1.25 \times U_s$, for Railway Applications

3RH11 contactor relays

Overview

DC operation

IEC 60947-4-1, EN 60947-4-1 (VDE 0660, Part 102), for requirements according to IEC 60077-1 and IEC 60077-2.

The contactor relays are finger-safe according to EN 50274. The size S00 contactor relays have Cage Clamp connections for all terminals.

Ambient temperature

The permissible ambient temperature for operation of the contactor relays (across the full magnetic coil operating range) is -40 °C to $+70 \text{ °C}$.

Uninterrupted duty at temperatures $> +60 \text{ °C}$ reduces the mechanical endurance, the current-carrying capacity of the conducting paths and the switching frequency.

Function

Control and auxiliary circuits

The magnetic coils of the contactor relays have an extended operating range from 0.7 to $1.25 \times U_s$ and are fitted as standard with varistors to provide protection against overvoltage. The opening delay is consequently 2 to 5 ms longer than for standard contactors.

3RH11 ..-0LA0

The DC solenoid systems of the contactor relays are modified (to holding excitation) by means of a series resistor.

The size S00 contactor relays are supplied prewired with a plug-on module containing the series resistor. The varistor is integrated. A 4-pole auxiliary switch block (according to EN 50005) can be fitted additionally.

Mounting

At ambient temperatures up to 70 °C , the size S00 contactor relays are allowed to be mounted side by side.

3RH11 22-2K.40

These contactor relays have an extended operating range from 0.7 to $1.25 \times U_s$; the coils are fitted with varistors as standard. An additional series resistor is not required. Please note:

- Size S00: it is not possible to mount an auxiliary switch block.

At ambient temperatures $> 60 \text{ °C} \leq 70 \text{ °C}$, a clearance of 10 mm is required when they are mounted side by side.

Technical specifications

Contactors	Type		3RH11 .
Magnetic coil operating range	AC/DC		$0.7 \dots 1.25 \times U_s$
Power consumption of the magnetic coils			For cold coil and $1.0 \times U_s$
• Contactors with series resistor	- Closing	W	11
	- Closed	W	4
• Contactors without series resistor	- Closing	W	2.3
	- Closed	W	2.3
Upright mounting position			3RH11 22-2K.40: please ask 3RH11 22-2K.40-0LA0 standard version

All specifications and technical specifications not mentioned here are identical to those of the standard contactors.

3RT, 3RH, 3TB, 3TC, 3TH, 3TK Contactors for Special Applications

Contactors with Extended Operating Range $0.7 \dots 1.25 \times U_s$, for Railway Applications

3TH4 contactor relays

Overview

3TH4 contactor relays

EN 60947-4-1.

For requirements according to IEC 60077-1 and IEC 60077-2.

The contactors are finger-safe according to EN 50274. Terminal covers may have to be fitted onto the connecting bars, depending on the configuration with other devices.

Function

Control and auxiliary circuits

The magnetic coils of the contactors have an extended coil operating range from 0.7 to $1.25 \times U_s$ and are fitted as standard with varistors to provide protection against overvoltage. The opening delay is consequently 2 ms to 5 ms longer than for standard contactors.

All specifications and technical specifications not mentioned here are identical to those of the standard 3TH4 contactor relays.

Ambient temperature

The permissible ambient temperature for operation of the contactors (across the full operating range of the magnetic coil) is -50 to $+70$ °C. Uninterrupted duty at temperatures < -25 °C and $> +55$ °C reduces the mechanical endurance, the current-carrying capacity of the conducting paths and the switching frequency.

Mounting

At ambient temperatures > 55 °C, a distance of 10 mm must be observed if contactor relays and size 1 and 2 contactors are mounted side by side. There is no need to reduce the technical specifications.

Technical specifications

Contactors	Type	3TH42	
Magnetic coil operating range		$0.7 \dots 1.25 \times U_s$	
Power consumption of the magnetic coils (for cold coil)			
	$0.7 \times U_s$ W	2.6	
	$1.0 \times U_s$ W	5.2	
	$1.25 \times U_s$ W	8.2	
(For cold coil: Closing = Closed)			
Permissible ambient temperature	• During operation	°C	$-50 \dots +70$ ¹⁾
	• During storage	°C	$-55 \dots +80$
Permissible residual current of the electronics (with 0 signal)	DC operation	$\leq 10 \text{ mA} \times (24 \text{ V}/U_s)$	
Operating times (Total break time = OFF-delay + Arcing time)			
• Closing			
- $0.7 \times U_s$	ON-delay (NO)	ms	70 ... 200
	OFF-delay (NC)	ms	28 ... 33
- $1 \times U_s$	ON-delay (NO)	ms	45 ... 80
	OFF-delay (NC)	ms	30 ... 34
- $1.25 \times U_s$	ON-delay (NO)	ms	40 ... 60
	OFF-delay (NC)	ms	31 ... 35
• Opening			
- $0.7 \dots 1.25 \times U_s$	OFF-delay (NO)	ms	20 ... 30
	ON-delay (NC)	ms	22 ... 32
• Arcing time			
		ms	10

¹⁾ Side-by-side mounting with 10 mm distance.

3RT, 3RH, 3TB, 3TC, 3TH, 3TK Contactors for Special Applications

Contactors with Extended Operating Range $0.7 \dots 1.25 \times U_s$, for Railway Applications

3RT10 motor contactors, 5.5 ... 45 kW

Overview

DC operation

IEC 60947-4-1, EN 60947-4-1 (VDE 0660, Part 102), for requirements according to IEC 60077-1 and IEC 60077-2.

The contactors are finger-safe according to EN 50274 (exception: series resistors S0 to S3). The contactors are available with both Cage Clamp and screw connection. The size S00 contactors have Cage Clamp terminals for all connections. The auxiliary conductor and coil terminals of sizes S0 to S3 are all Cage Clamp terminals.

Ambient temperature

The permissible ambient temperature for operation of the contactors (across the full magnetic coil operating range) is $-40 \text{ }^\circ\text{C}$ to $+70 \text{ }^\circ\text{C}$.

Uninterrupted duty at temperatures $> +60 \text{ }^\circ\text{C}$ reduces the mechanical endurance, the current-carrying capacity of the conducting paths and the switching frequency.

Dimensions

Attaching resistors increases the width of contactor sizes S0 to S3 (see "Dimensional Drawings").

Function

Control and auxiliary circuits

The magnetic coils of the contactors have an extended operating range from 0.7 to $1.25 \times U_s$ and are fitted as standard with varistors to provide protection against overvoltage. The opening delay is consequently 2 to 5 ms longer than for standard contactors.

3RT10 ..-0LA0

The DC solenoid systems of the contactors are modified (to holding excitation) by means of a series resistor.

The size S00 contactors are supplied prewired with a plug-on module containing the series resistor. The varistor is integrated. A 4-pole auxiliary switch block (according to EN 50005) can be fitted additionally.

The size S0 to S3 contactors are equipped on the front with an auxiliary switch block with 2 NO + 2 NC contacts. The separate series resistor, which is attached laterally next to the contactor on the 35 mm standard mounting rail, is fitted with connecting cables for mounting onto contactors. A circuit diagram showing the terminals is stuck onto each contactor. One NC of the auxiliary contacts is required for the series resistor function. The selection and ordering data shows the number of additional, unassigned auxiliary contacts. It is only possible to extend the number of auxiliary contacts with size S00.

Mounting

At ambient temperatures up to $70 \text{ }^\circ\text{C}$, the size S00 contactors and contactor relays are allowed to be mounted side by side. The resistor module of the size S0 to S3 contactors must be mounted to the left of the contactor owing to the prefabricated connecting cables.

3RT10 17-2K.4., 3RT10 2.-3K.40

These contactors have an extended operating range from 0.7 to $1.25 \times U_s$; the coils are fitted with varistors as standard. An additional series resistor is not required. Please note:

- Size S00: it is not possible to mount an auxiliary switch block.
- Size S0: up to two single-pole auxiliary switch blocks can be mounted.

At ambient temperatures $> 60 \text{ }^\circ\text{C} \leq 70 \text{ }^\circ\text{C}$, a clearance of 10 mm is required when they are mounted side by side.

3RT10 contactors with contactor control unit, extended operating range

Control and auxiliary circuits

The magnetic coils of the contactors have an extended operating range from 0.7 to $1.25 \times U_s$ and are fitted as standard with varistors to provide protection against overvoltage. The opening delay is consequently 2 ms to 5 ms longer than for standard contactors.

3RT10 ...-X.40-0LA2

The contactors are energized via upstream control electronics which ensure the coil operating range of 0.7 to $1.25 \times U_s$ at an ambient temperature of $70 \text{ }^\circ\text{C}$. They are supplied as complete units with a built-on contactor control unit. A varistor is integrated for damping opening surges in the coil.

The possibility of mounting auxiliary switches is the same as that for equivalent standard contactors.

Mounting

At ambient temperatures up to $70 \text{ }^\circ\text{C}$, sizes S0 to S3 of these contactor versions are allowed to be mounted side by side.

Ambient temperature

The permissible ambient temperature for operation of the contactors (across the full operating range of the magnetic coil) is $-40 \text{ }^\circ\text{C}$ to $+70 \text{ }^\circ\text{C}$.

Uninterrupted duty at temperatures $> +60 \text{ }^\circ\text{C}$ reduces the mechanical endurance, the current-carrying capacity of the conducting paths and the switching frequency.

Dimensions

Because of the built-on contactor control unit, the height of the size S0 to S3 contactors increases by up to 34 mm (see "Dimensional Drawings").

3RT, 3RH, 3TB, 3TC, 3TH, 3TK Contactors for Special Applications

Contactors with Extended Operating Range $0.7 \dots 1.25 \times U_s$, for Railway Applications

3RT10 motor contactors, 5.5 ... 45 kW

Technical specifications

Contactors	Type		3RT10 17	3RT10 2.	3RT10 3.	3RT10 4.
Magnetic coil operating range	AC/DC		$0.7 \dots 1.25 \times U_s$			
Power consumption of the magnetic coils			For cold coil and $1.0 \times U_s$			
• Contactors with series resistor	- Closing	W	11	23	46	78
	- Closed	W	4	7	14	23
• Contactors without series resistor	- Closing	W	2.3	4.2	--	--
	- Closed	W	2.3	4.2	--	--
Upright mounting position			Standard version	3RT10 2.-3K.40: Special version required 3RT10 2.- 3K.44-0LA0: Special version required	--	--

All specifications and technical specifications not mentioned here are identical to those of the standard contactors.

Contactors			3RT10 2.	3RT10 3.	3RT10 4.
3RT10 contactors with contactor control unit					
Magnetic coil operating range			$0.7 \dots 1.25 \times U_s$		
Power consumption			For cold coil and $1.0 \times U_s$		
	• Closing	W	6	15	19
	• Closed	W	5.4	11	12
Upright mounting position			Special version required	--	--

All specifications and technical specifications not mentioned here are identical to those of the standard contactors.

3RT, 3RH, 3TB, 3TC, 3TH, 3TK Contactors for Special Applications

Contactors with Extended Operating Range $0.7 \dots 1.25 \times U_s$, for Railway Applications

3TB5 motor contactors, 55 ... 200 kW

Overview

EN 60947-4-1.

For requirements according to IEC 60077-1 and IEC 60077-2.

The contactors are finger-safe according to EN 50274. Terminal covers may have to be fitted onto the connecting bars, depending on the configuration with other devices.

Function

Control and auxiliary circuits

The magnetic coils of the contactors have an extended coil operating range from 0.7 to $1.25 \times U_s$ and are fitted as standard with varistors to provide protection against overvoltage. The opening delay is consequently 2 ms to 5 ms longer than for standard contactors.

The DC solenoid systems of the 3TB contactors must be modified (to holding excitation) by means of a series resistor.

This series resistor is supplied separately packed with the contactors. With types 3TB50, the series resistor must be attached onto the right-hand side of the auxiliary switch block by means of the enclosed mounting parts and sets of links provided.

With types 3TB52/54/56, the series resistor must be attached separately next to the contactors. One NC of the auxiliary contacts is required for the series resistor function. The selection

and ordering data show the number of additional, unassigned auxiliary contacts. It is not possible to extend the number of auxiliary contacts.

With the 3TB52 and larger contactors, the series resistor must be connected using an additional K2 reversing contactor (3RT13 17-1F.40). This contactor is automatically included in the scope of supply in the same packaging as the contactor.

All specifications and technical specifications not mentioned here are identical to those of the standard 3TB contactors.

Ambient temperature

The permissible ambient temperature for operation of the contactors (across the full operating range of the magnetic coil) is -50 to $+70$ °C. Uninterrupted duty at temperatures < -25 °C and $> +55$ °C reduces the mechanical endurance, the current-carrying capacity of the conducting paths and the switching frequency.

Mounting

At ambient temperatures > 55 °C, a distance of 10 mm must be observed if contactor relays and size 1 and 2 contactors are mounted side by side. There is no need to reduce the technical specifications.

Dimensions

Attaching resistors and varistors increases the width of the contactors (see "Dimensional Drawings").

Technical specifications

Contactors	Type	3TB50	3TB52	3TB54	3TB56
Magnetic coil operating range		$0.8 \dots 1.1 \times U_s$			
Power consumption of the magnetic coils		For cold coil and $1.0 \times U_s$			
• Closing	W	38	40	190	295
• Closed	W	20	21	43	59

3RT, 3RH, 3TB, 3TC, 3TH, 3TK Contactors for Special Applications

Contactors with Extended Operating Range $0.7 \dots 1.25 \times U_s$, for Railway Applications

3TC contactors for switching DC voltage, 2-pole

Overview

EN 60947-4-1.

For requirements according to IEC 60077-1 and IEC 60077-2.

The contactors are finger-safe according to EN 50274 (exception: series resistor). Terminal covers may have to be fitted onto the connecting bars, depending on the configuration with other devices.

Function

Control and auxiliary circuits

The magnetic coils of the contactors have an extended coil operating range from 0.7 to $1.25 \times U_s$ and are fitted as standard with varistors to provide protection against overvoltage. The opening delay is consequently 2 ms to 5 ms longer than for standard contactors.

The DC solenoid systems of the 3TC contactors must be modified (to holding excitation) by means of a series resistor.

This series resistor is supplied separately packed with the contactors. With types 3TC48, the series resistor must be attached onto the right-hand side of the auxiliary switch block by means of the enclosed mounting parts and sets of links provided, while in the case of the 3TC44 it must be mounted and wired between the contactor poles. With types 3TC52/56, the series resistor must be attached separately next to the contactors. One NC of the auxiliary contacts is required for the series resistor function.

The selection and ordering data show the number of additional, unassigned auxiliary contacts. It is not possible to extend the number of auxiliary contacts.

With the 3TC52 and larger contactors, the series resistor must be connected using an additional K2 reversing contactor (3RT13 17-1F.40). This contactor is automatically included in the scope of supply in the same packaging as the contactor.

All specifications and technical specifications not mentioned here are identical to those of the standard 3TC contactors.

Ambient temperature

The permissible ambient temperature for operation of the contactors (across the full operating range of the magnetic coil) is -50 to $+70$ °C. Uninterrupted duty at temperatures < -25 °C and $> +55$ °C reduces the mechanical endurance, the current-carrying capacity of the conducting paths and the switching frequency.

Mounting

At ambient temperatures > 55 °C, a distance of 10 mm must be observed if contactor relays and size 1 and 2 contactors are mounted side by side. There is no need to reduce the technical specifications.

Dimensions

Attaching resistors and varistors increases the width of the contactors (see "Dimensional Drawings").

Technical specifications

Contactors	Type	3TC44	3TC48	3TC52	3TC56
Magnetic coil operating range		$0.7 \dots 1.25 \times U_s$			
Power consumption of the magnetic coils		For cold coil and $1.0 \times U_s$			
• Closing	W	48	26	40	295
• Closed	W	13	14	21	59

3RT, 3RH, 3TB, 3TC, 3TH, 3TK Contactors for Special Applications

3TC Contactors for Switching DC Voltage

1- and 2-pole, 32 ... 400 A

Overview

3TC4 and 3TC5

EN 60947-4-1 (VDE 0660 Part 102).

The contactors are finger-safe according to EN 50274.

Terminal covers may have to be fitted onto the connecting bars, depending on the configuration with other devices.

The DC motor ratings given in the tables are applicable to the DC-3 and DC-5 utilization categories with two-pole switching of the load or with the two conducting paths of the contactor connected in series.

One contactor conducting path can switch full power up to 220 V. The ratings for higher voltages are available on request.

3TC7

EN 60947-4-1 (VDE 0660 Part 102).

The contactors are suitable for use in any climate. They are suitable for switching and controlling DC motors as well as all other DC loads. The electromagnetic excitation is designed for a particularly wide coil operating range.

It is between 0.7 or 0.8 to $1.2 \times U_s$.

3TC74 contactors can be used at up to 750 V/400 A and 50 Hz in AC-1 operation.

Technical specifications

Contactors	Type		3TC4 and 3TC7	3TC5
Rated data of the auxiliary contacts				
Rated insulation voltage U_i (degree of pollution 3)		V	690	
Continuous thermal current I_{th} = Rated operational current $I_e/AC-12$			10	10
AC load Rated operational current $I_e/AC-15/AC-14$ • For rated operational voltage U_e				
	24 V	A	10	10
	110 V	A	10	10
	125 V	A	10	10
	220 V	A	6	6
	230 V	A	5.6	5.6
	380 V	A	4	4
	400 V	A	3.6	3.6
	500 V	A	2.5	2.5
	660 V	A	2.5	2.5
	690 V	A	--	--
DC load Rated operational current $I_e/DC-12$ • For rated operational voltage U_e				
	24 V	A	10	10
	60 V	A	10	10
	110 V	A	3.2	8
	125 V	A	2.5	6
	220 V	A	0.9	2
	440 V	A	0.33	0.6
	600 V	A	0.22	0.4
Rated operational current $I_e/DC-13$ • For rated operational voltage U_e				
	24 V	A	10	10
	60 V	A	5	5
	110 V	A	1.14	2.4
	125 V	A	0.98	2.1
	220 V	A	0.48	1.1
	440 V	A	0.13	0.32
	600 V	A	0.07	0.21
Contactors	Type		3TC44 ... 3TC56	
Ⓢ and Ⓣ ratings of the auxiliary contacts				
Rated voltage		V AC, max.	600	
Switching capacity			A 600, P 600	

3RT, 3RH, 3TB, 3TC, 3TH, 3TK Contactors for Special Applications

3TC Contactors for Switching DC Voltage

1- and 2-pole, 32 ... 400 A

Contactors

Type

3TC44 ... 3TC78

Endurance of the main contacts

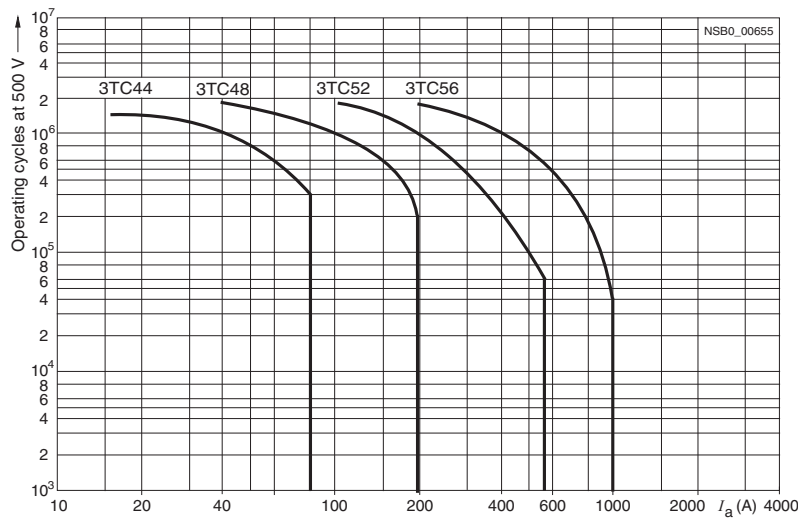

3TC44 to 3TC56 contactors

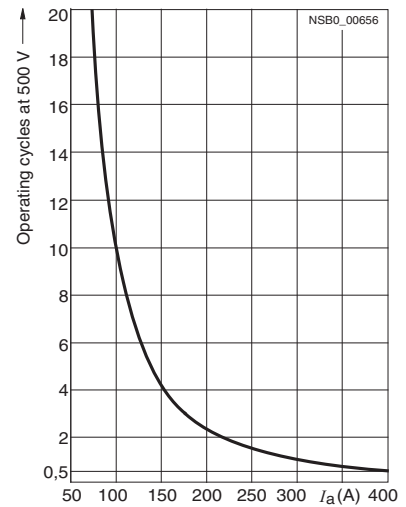

3TC74 and 3TC78 contactors

Diagram legend:
 I_a = Breaking current

Contactors	Type	Size	3TC44	3TC48	3TC52	3TC56
			2	4	8	12
General data						
Permissible mounting position The contactors are designed for operation on a vertical mounting surface.						
Mechanical endurance	Operating cycles		10 million			
Electrical endurance	Operating cycles		1)			
Rated insulation voltage U_i (degree of pollution 3)	V		800		1000	
Protective separation between the coil and the main contacts acc. to EN 60947-1, Appendix N	V		Up to 300		Up to 660	
Mirror contacts²⁾ A mirror contact is an auxiliary NC contact that cannot be closed simultaneously with a NO main contact.			Yes, acc. to EN 60947-4-1, Appendix F			
Permissible ambient temperature	<ul style="list-style-type: none"> • During operation • During storage 	°C	-25 ... +55			
		°C	-50 ... +80			
Degree of protection acc. to EN 60947-1, Appendix C			IP00/open, for AC operation, coil assembly IP40			
Shock resistance	Rectangular pulse	g/ms	7.5/5 and 3.4/10	10/5 and 5/10	12/5 and 5.5/10	12/5 and 5.6/10
Short-circuit protection						
Main circuit						
Fuse links gL/gG	• Type of coordination "1"	A	50	160	250	400
LV HRC 3NA, DIAZED 5SB, NEOZED 5SE	• Type of coordination "2"	A	35	63	80	250
Auxiliary circuit (short-circuit current $I_k \geq 1$ kA)						
• Fuse links, gL/gG DIAZED 5SB, NEOZED 5SE		A	16			
• Miniature circuit breaker with C characteristic		A	10			

For the rated data of the auxiliary contacts see page 3/126.

¹⁾ See the endurance diagram above.

²⁾ For 3TC44, one NC contact each must be connected in series for the right and left auxiliary switch block respectively.

3RT, 3RH, 3TB, 3TC, 3TH, 3TK Contactors for Special Applications

3TC Contactors for Switching DC Voltage

1- and 2-pole, 32 ... 400 A

Contactors	Type Size		3TC44 2	3TC48 4	3TC52 8	3TC56 12
Control						
Magnetic coil operating range			0.8 ... 1.1 x U_s			
Power consumption of the magnetic coils (for cold coil and 1.0 x U_s)						
• DC operation	- Closing = Closed	W	10	19	30	86
• AC operation, 50 Hz coil	- Closing	VA/p.f.	68/0.86	300/0.5	640/0.48	1780/0.3
	- Closed	VA/p.f.	10/0.29	26/0.24	46/0.23	121/0.22
• AC operation, 60 Hz coil	- Closing	VA/p.f.	95/0.79	365/0.45	730/0.38	2140/0.3
	- Closed	VA/p.f.	12/0.3	35/0.26	56/0.24	140/0.29
• AC operation, 50/60 Hz coil	- Closing at 50 Hz/60 Hz	VA/p.f.	79/73/0.83/0.78	--	--	--
	- Closed at 50 Hz/60 Hz	VA/p.f.	11/9/0.28/0.27	--	--	--
Operating times (at 0.8 ... 1.1 x U_s) Total break time = opening delay + Arcing time			(The values apply up to and including 20 % undervoltage, 10 % overvoltage, as well as when the coil is cold and warm)			
• DC operation	- Closing delay	ms	35 ... 190	90 ... 380	120 ... 400	110 ... 400
	- Opening delay ¹⁾	ms	10 ... 25	17 ... 28	22 ... 35	40 ... 110
• AC operation	- Closing delay	ms	10 ... 40	20 ... 50	20 ... 50	20 ... 50
	- Opening delay ¹⁾	ms	5 ... 25	5 ... 30	10 ... 30	10 ... 30
• Arcing time	- DC-1	ms	20			
	- DC-3/DC-5	ms	30			
Main circuit						
Load rating with DC						
Utilization category DC-1, switching resistive loads ($L/R \leq 1$ ms)						
• Rated operational currents I_e (at 55 °C)	Up to U_e 750 V	A	32	75	220	400
• Minimum conductor cross-section		mm ²	6	25	95	240
• Rated power at U_e	At 220 V	kW	7	16.5	48	88
	440 V	kW	14	33	97	176
	600 V	kW	19.2	45	132	240
	750 V	kW	24	56	165	300
Utilization category DC-3 and DC-5 Shunt-wound and series-wound motors ($L/R \leq 15$ ms)						
• Rated operational currents I_e (at 55 °C)	Up to 220 V	A	32	75	220	400
	440 V	A	29	75	220	400
	600 V	A	21	75	220	400
	750 V	A	7.5	75	170	400
• Rated power at U_e	At 110 V	kW	2.5	6.5	20	35
	220 V	kW	5	13	41	70
	440 V	kW	9	27	82	140
	600 V	kW	9	38	110	200
	750 V	kW	4	45	110	250
Switching frequency						
Switching frequency z in operating cycles/hour						
AC/DC operation	• With resistive load DC-1 • For inductive load DC-3/DC-5	h ⁻¹ h ⁻¹	1500 750	1000 600		
Conductor cross-sections (1 or 2 conductors connectable)						
Main conductors:			 Screw terminals			
• Solid		mm ²	2 x (2.5 ... 10)	2 x (6 ... 16)	--	--
• Finely stranded with end sleeve		mm ²	2 x (1.5 ... 4)	--	--	--
• Stranded with cable lug		mm ²	2 x 16	2 x 35	2 x 120	2 x 150
• Pin-end connector to DIN 46231		mm ²	2 x (1 ... 6)	--	--	--
• Busbars		mm	--	15 x 2.5	25 x 4	2 x (25 x 3)
• Terminal screw		mm	M5	M6	M10	M10
Auxiliary conductors:						
• Solid		mm ²	2 x (1 ... 2.5)			
• Finely stranded with end sleeve		mm ²	2 x (0.75 ... 1.5)			

For the rated data of the auxiliary contacts see page 3/126.

¹⁾ The opening delay times can increase if the contactor coils are damped against voltage peaks. Only 3TC44 contactors are allowed to be fitted with diodes.

3RT, 3RH, 3TB, 3TC, 3TH, 3TK Contactors for Special Applications

3TC Contactors for Switching DC Voltage

1- and 2-pole, 32 ... 400 A

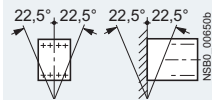
Contactors	Type	3TC74 1-pole contactors	3TC78 2-pole contactors
General data			
Permissible mounting position The contactors are designed for operation on a vertical mounting surface.			
Mechanical endurance	Operating cycles	30 million	
Electrical endurance	Operating cycles	1)	
Rated insulation voltage U_i (degree of pollution 3)	V	1500	
Rated impulse withstand voltage U_{imp}	kV	8	
Protective separation between the coil and the main contacts acc. to EN 60947-1, Appendix N	V	630	
Permissible ambient temperature	°C	-25 ... +55	
Degree of protection acc. to EN 60947-1 Appendix C		IP00/open	
Short-circuit protection			
Main circuit			
Fuse links, gL/gG	• Type of coordination "1":	A	630
LV HRC 3NA	• Type of coordination "2":	A	500
Auxiliary circuit (short-circuit current $I_k \geq 1$ kA)			
• Fuse links, gL/gG operational class DIAZED Type 5SB, NEOZED Type 5SE		A	16
• Miniature circuit breaker with C characteristic		A	10
Control			
Magnetic coil operating range			
• DC operation	24 V > 24 V	0.8 ... 1.2 x U_s 0.7 ... 1.2 x U_s	
• AC operation	24 V > 24 V	0.7 ... 1.15 x U_s 0.7 ... 1.14 x U_s	
Power consumption of the magnetic coils (when coil is cold and 1.0 x U_s)			
• DC operation	Closing = Closed	W	46
• AC operation, 50 Hz	Closing, Closed	VA	80/0.95
			92
			160/0.95
Operating times (Total break time = Opening delay + Arcing time)			
• AC and DC operation	- Closing delay	ms	60 ... 100
	- Opening delay	ms	20 ... 35
• Arcing time at 0.06 ... 4 x I_e		ms	40 ... 70
Main circuit			
Load rating with DC			
Utilization category DC-1, switching resistive loads ($L/R \leq 1$ ms)			
• Rated operational current $I_e/DC-1$ (at 55 °C)	A	500	500
• Minimum conductor cross-section	mm ²	2 x 150	2 x 150
• Rated power at			
	220 V	kW	110
	440 V	kW	220
	600 V	kW	300
	750 V	kW	375
	1200 V	kW	--
	1500 V	kW	--
			750
• Critical currents, without arc extinction			
	440 V	A	≤ 7
	600 V	A	≤ 13
	750 V	A	≤ 15
	≤ 800 V	A	--
	1200 V	A	≤ 13
	1500 V	A	≤ 15
Utilization categories DC-3 and DC-5, switching DC motors			
Permissible rated current for regenerative braking At 110 ... 600 V		A	400
Switching frequency			
Switching frequency z in operating cycles/hour			
• AC/DC operation	- With resistive load DC-1	h ⁻¹	750
	- For inductive load, DC-3/DC-5	h ⁻¹	500
			1000
			500
Conductor cross-section			
Main conductors:			
• Stranded with cable lug	mm ²	2 x ... 150	
• Busbars	mm	2 x (30 x 4)	
Auxiliary conductors:			
• Solid	mm ²	1 ... 2.5	
• Finely stranded with end sleeve	mm ²	0.75 ... 1.5	

For the rated data of the auxiliary contacts see page 3/126.

1) For endurance see page 3/127.

2) See selection table in Catalog LV 1.

3RH, 3TH Contactor Relays

3RH1 contactor relays, 4- and 8-pole

Overview

The SIRIUS generation of controls is a complete, modular system family, logically designed right down to the last detail, from the basic units to the accessories.

Contactor relays and coupling relays Size S00 with accessories

AC and DC operation

IEC 60947, EN 60947 (VDE 0660)

The 3RH1 contactor relays are suitable for use in any climate. They are finger-safe according to EN 50274.

The 3RH1 contactor relays have screw or Cage Clamp terminals. Four contacts are available in the basic unit.

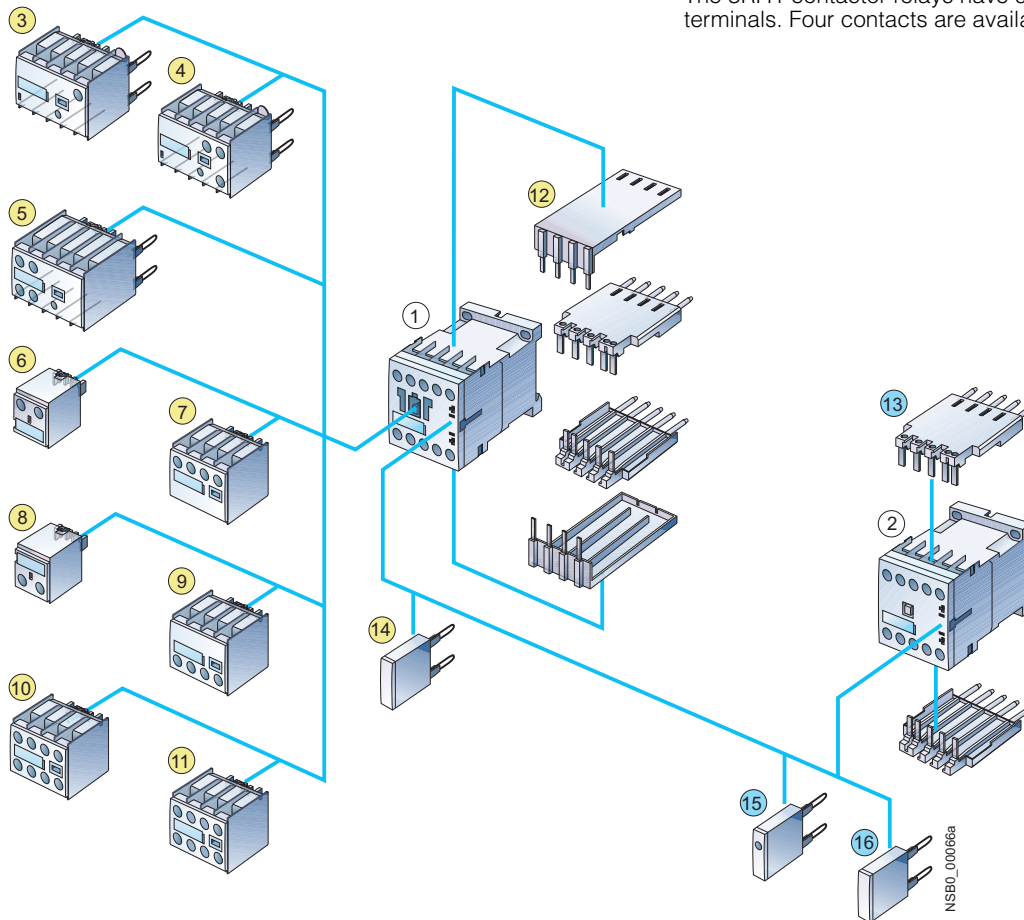

- ① Contactor relay
- ② Coupling relay for auxiliary circuits
- ③ Solid-state timing relay block, with ON-delay
- ④ Solid-state timing relay block, with OFF-delay
- ⑤ Auxiliary switch block, with solid-state time-delay (versions: ON or OFF-delay)
- ⑥ 1-pole auxiliary switch block, cable entry from above
- ⑦ 2-pole auxiliary switch block, cable entry from above
- ⑧ 1-pole auxiliary switch block, cable entry from below
- ⑨ 2-pole auxiliary switch block, cable entry from below
- ⑩ 4-pole auxiliary switch block (terminal designations according to EN 50011 or EN 50005)
- ⑪ 2-pole auxiliary switch block, standard version or solid-state time-delay version (terminal designations according to EN 50005)
- ⑫ Solder pin adapter for contactor relays with 4-pole auxiliary switch block
- ⑬ Solder pin adapter for contactor relays and coupling relays
- ⑭ Additional load module for increasing the permissible residual current
- ⑮ Surge suppressor with LED
- ⑯ Surge suppressor without LED

3RH1 contactor relays, 4- and 8-pole

Function**Contact reliability**

High contact stability at low voltages and currents, suitable for solid-state circuits with currents ≥ 1 mA at a voltage of 17 V.

Surge suppression

RC elements, varistors, diodes or diode assemblies (combination of a diode and a Zener diode) can be plugged onto all contactor relays from the front for damping opening surges in the coil. The plug-in direction is determined by a coding device.

Note:

The OFF-delay times of the NO contacts and the ON-delay times of the NC contacts increase if the contactor coils are damped against voltage peaks (noise suppression diode 6 to 10 times; diode assemblies 2 to 6 times, varistor +2 to 5 ms).

Integration**Auxiliary switch blocks**

The 3RH1 contactor relays can be expanded by up to four contacts by the addition of snap-on auxiliary switch blocks.

The auxiliary switch block can easily be snapped onto the front of the contactors. The auxiliary switch block has a centrally positioned release lever for disassembly.

The contactor relays with 4 contacts according to EN 50011, with the identification number 40E, can be extended with 80E to 44E auxiliary switch blocks to obtain contactor relays with 8 contacts according to EN 50011. The identification numbers 80E to 44E on the auxiliary switch blocks apply to the complete contactors. These auxiliary switch blocks (3RH19 11-1GA ..) cannot be combined with contactor relays with identification numbers 31E and 22E; they are coded.

All contactor relays with 4 contacts according to EN 50011, identification numbers 40E to 22E, can be extended with auxiliary switch blocks 40 to 02 to obtain contactor relays with 6 or 8 contacts in accordance with EN 50005. The identification numbers on the auxiliary switch blocks apply only to the attached auxiliary switch blocks.

In addition, fully mounted 3RH12 8-pole contactor relays are available; the mounted 4-pole auxiliary switch block in the 2nd tier is not removable.

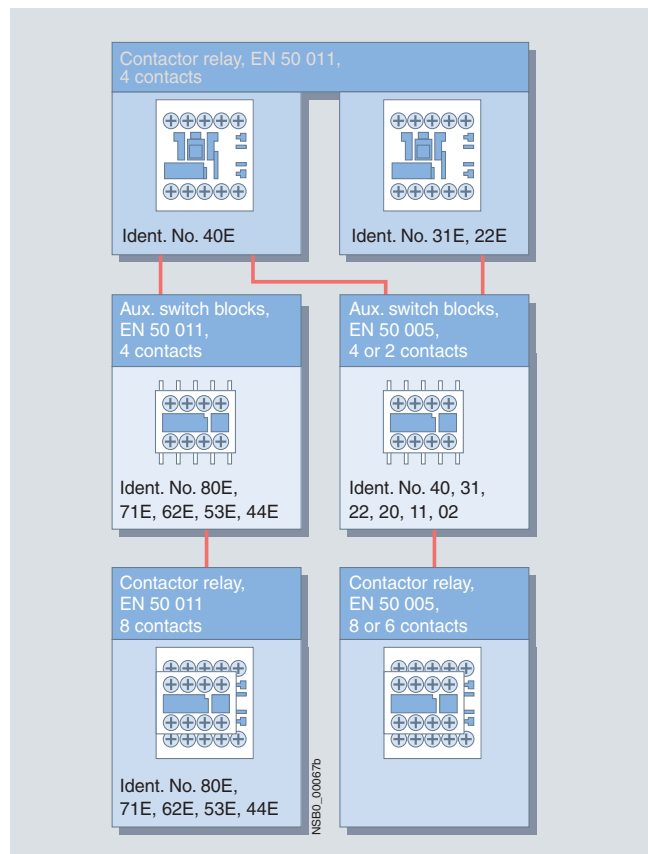

The terminal designations comply with EN 50011. These versions are built in accordance with special Swiss regulations (SUVA) and are distinguished externally by a red labeling plate.



3RH, 3TH Contactor Relays

3RH1 contactor relays, 4- and 8-pole

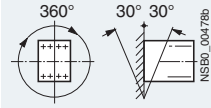
Technical specifications

Contactor	Type Size	3RH1 S00
Permissible mounting position		
The contactors are designed for operation on a vertical mounting surface.	• AC and DC operation	
Upright mounting position (only for 3RH11/3RH12/3RH14)	• AC operation	
	• DC operation	Special version required Standard version (for coupling relays and contactor relays with extended operating range 3RH11 22-2K.40, please ask)

Positively-driven operation of contacts in contactor relays

3RH1:

Yes, in the basic unit and the auxiliary switch block as well as between the basic unit and the snap-on auxiliary switch block (removable) acc. to:

- ZH 1/457
- EN 60947-5-1, Appendix L

3RH12:

Yes, in the basic unit and the auxiliary switch block as well as between the basic unit and the snap-on auxiliary switch block (fixed) acc. to:

- ZH 1/457
- EN 60947-5-1, Appendix L
- SUVA

Note:

3RH19 11- NF solid-state compatible auxiliary switch blocks have no positively-driven contacts.

Explanations:

There is positively-driven operation if it is ensured that the NC and NO contacts cannot be closed at the same time.

ZH1/457

Safety rules for control units on power-operated presses in the metal-working industry.

EN 60947-5-1, Appendix L

Low-voltage controlgear, control equipment, and switching elements. Special requirements for positively-driven contacts

SUVA

Accident prevention regulations of the "Schweizer Unfallverhütungsanstalt" (Swiss Institute for Accident Insurance)

Contact reliability

Contact reliability at 17 V, 1 mA acc. to EN 60947-5-4

Frequency of contact faults $<10^{-8}$, i. e. <1 fault per 100 million operating cycles

Contact endurance for AC-15/AC-14 and DC-13 utilization categories

The contact endurance is mainly dependent on the breaking current. It is assumed that the operating mechanisms are switched randomly, i. e. not synchronized with the phase angle of the supply system. If magnetic circuits other than the contactor coil systems or solenoid valves are present, e.g. magnetic brakes, protective measures for the load circuits are necessary.

RC elements and freewheel diodes would be suitable as protective measures.

The characteristic curves apply to:

- 3RH11, 3RH12 contactor relays
- 3RH14 latched contactor relays
- 3RH19 11 auxiliary switch blocks.

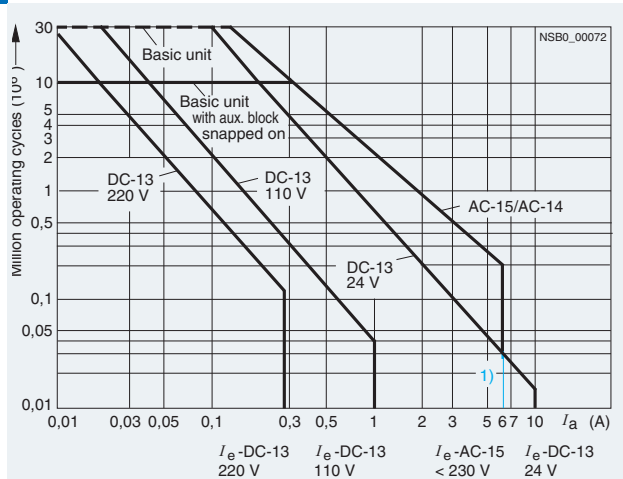

Diagram legend:

I_a = Breaking current

I_e = Rated operational current

1) Snap-on auxiliary switch blocks: $I_e/DC-13$ max. 6 A.

3RH, 3TH Contactor Relays

3RH1 contactor relays, 4- and 8-pole

Contactors	Type Size	3RH11, 3RH12 S00	3RH14 S00
Ⓢ and Ⓛ ratings			
Basic units and auxiliary switch blocks			
• Rated control supply voltage	V AC	Max. 600	
• Rated voltage	V AC	600	
• Switching capacity		A 600, Q 600	
• Uninterrupted current at 240 V AC	A	10	
General data			
Mechanical endurance	• Basic units	Operating cycles	30 million
	• Basic unit with snap-on auxiliary switch block	Operating cycles	10 million
	• Solid-state compatible auxiliary switch block	Operating cycles	5 million
Rated insulation voltage U_i (degree of pollution 3)	V	690	
Rated impulse withstand voltage U_{imp}	kV	6	
Protective separation between the coil and the contacts in the basic unit acc. to EN 60947-1, Appendix N	V	400	
Permissible ambient temperature	• During operation • During storage	°C	-25 ... +60 -55 ... +80
Degree of protection acc. to EN 60947-1, Appendix C			IP20, coil assembly IP40
Touch protection acc. to EN 50274			Finger-safe
Shock resistance			
• Rectangular pulse	AC/DC operation	g/ms	10/5 and 5/10
• Sine pulse	AC/DC operation	g/ms	15/5 and 8/10
Conductor cross-sections (1 or 2 conductors connectable)			
Auxiliary conductor and coil terminals			⊕ Screw terminals
• Solid	mm ²	2 x (0.5 ... 1.5) 2 x (0.75 ... 2.5) acc. to IEC 60947; max. 2 x (1 ... 4)	
• Finely stranded with end sleeve	mm ²	2 x (0.5 ... 1.5) 2 x (0.75 ... 2.5)	
• AWG cables, solid or stranded	AWG	2 x (20 ... 16) 2 x (18 ... 14) 1 x 12	
• Terminal screws		M3	
- Tightening torque	Nm	0.8 ... 1.2 (7 ... 10.3 lb.in)	
Auxiliary conductor and coil terminals			⊖ Cage Clamp terminals
• Solid	mm ²	2 x (0.25 ... 2.5)	
• Finely stranded with end sleeve	mm ²	2 x (0.25 ... 1.5)	
• Finely stranded without end sleeve	mm ²	2 x (0.25 ... 2.5)	
• AWG cables, solid or stranded	AWG	2 x (24 ... 14)	
Short-circuit protection			
(weld-free protection at $I_k \geq 1$ kA)			
• Fuse links, gL/gG operational class			
- DIAZED, Type 5SB	A	10	
- NEOZED, Type 5SE	A	10	
• Or miniature circuit breakers with C characteristic (short-circuit current $I_k < 400$ A)	A	6	

For corresponding 8WA2 803/8WA2 804 opening tool, see Catalog LV 1.

An "insulation stop" must be used for conductor cross-sections ≤ 1 mm², see Catalog LV 1.

Note:

Maximum external diameter of the conductor insulation: 3.6 mm.

3RH, 3TH Contactor Relays

3RH1 contactor relays, 4- and 8-pole

Contactor	Type Size	3RH1- S00	
Control			
Magnetic coil operating range			
• AC operation		At 50 Hz At 60 Hz	0.8 ... 1.1 x U_s 0.85 ... 1.1 x U_s
• DC operation		At +50 °C At +60 °C	0.8 ... 1.1 x U_s 0.85 ... 1.1 x U_s
Power consumption of the magnetic coils (when coil is cold and 1.0 x U_s)			
• AC operation, 50 Hz	- Closing - Closed	VA/p.f. VA/p.f.	27/0.8 4.6/0.27
• AC operation, 60 Hz	- Closing - Closed	VA/p.f. VA/p.f.	24/0.75 3.5/0.27
• DC operation	- Closing = Closed	W	3.2
Permissible residual current of the electronics (with 0 signal)			
	• For AC operation ¹⁾ • For DC operation		< 3 mA x (230 V/ U_s) < 10 mA x (24 V/ U_s)
Operating times²⁾ (Total break time = OFF-delay + Arcing time)			
<u>AC operation</u> Values apply with coil in cold state and at operating temperature for operating range			
• Closing			
- ON-delay of NO contact	0.8 ... 1.1 x U_s 1.0 x U_s 3RH14 minimum operating time	ms ms ms	8 ... 35 10 ... 25 ≥ 35
- OFF-delay of NC contact	0.8 ... 1.1 x U_s 1.0 x U_s	ms ms	6 ... 20 7 ... 20
• Opening			
- OFF-delay of NO contact	0.8 ... 1.1 x U_s 1.0 x U_s 3RH14 minimum operating time	ms ms ms	4 ... 30 5 ... 30 ≥ 30
- ON-delay of NC contact	0.8 ... 1.1 x U_s 1.0 x U_s	ms ms	5 ... 30 7 ... 20
<u>DC operation</u>			
• Closing			
- ON-delay of NO contact	0.8 ... 1.1 x U_s 1.0 x U_s 3RH14 minimum operating time	ms ms ms	25 ... 100 30 ... 50 ≥ 100
- OFF-delay of NC contact	0.8 ... 1.1 x U_s 1.0 x U_s	ms ms	20 ... 90 25 ... 45
• Opening			
- OFF-delay of NO contact	0.8 ... 1.1 x U_s 1.0 x U_s 3RH14 minimum operating time	ms ms ms	7 ... 10 7 ... 9 ≥ 30
- ON-delay of NC contact	0.8 ... 1.1 x U_s 1.0 x U_s	ms ms	13 ... 16 13 ... 15
• Arcing time		ms	10 ... 15
Dependence of the switching frequency z' on the operational current I' and operational voltage U' : $z' = z \cdot (I_0/I') \cdot (400 \text{ V}/U')^{1.5} \cdot 1/\text{hy}$			

¹⁾ The 3RT19 16-1GA00 additional load module is recommended for higher residual currents, see Catalog LV 1.

²⁾ The OFF-delay of the NO contact and the ON-delay of the NC contact are increased if the contactor coils are attenuated against voltage peaks (noise suppression diode 6 to 10 times; diode assemblies 2 to 6 times, varistor +2 to 5 ms).

3RH1 contactor relays, 4- and 8-pole

Contactors	Type Size	3RH1. S00	
Load side			
Rated operational currents I_e			
AC-12		A	10
AC-15/AC-14	Up to 230 V	A	6
For rated operational voltage U_s	400 V	A	3
	500 V	A	2
	690 V	A	1
DC-12			
For rated operational voltage U_s			
• 1 conducting path	24 V	A	10
	60 V	A	6
	110 V	A	3
	220 V	A	1
	440 V	A	0.3
	600 V	A	0.15
• 2 conducting paths in series	24 V	A	10
	60 V	A	10
	110 V	A	4
	220 V	A	2
	440 V	A	1.3
	600 V	A	0.65
• 3 conducting paths in series	24 V	A	10
	60 V	A	10
	110 V	A	10
	220 V	A	3.6
	440 V	A	2.5
	600 V	A	1.8
DC-13			
For rated operational voltage U_s			
• 1 conducting path	24 V	A	10 ¹⁾
	60 V	A	2
	110 V	A	1
	220 V	A	0.3
	440 V	A	0.14
	600 V	A	0.1
• 2 conducting paths in series	24 V	A	10
	60 V	A	3.5
	110 V	A	1.3
	220 V	A	0.9
	440 V	A	0.2
	600 V	A	0.1
• 3 conducting paths in series	24 V	A	10
	60 V	A	4.7
	110 V	A	3
	220 V	A	1.2
	440 V	A	0.5
	600 V	A	0.26
Switching frequency z			
• In operating cycles/h during normal duty for utilization category	AC-12/DC-12	h ⁻¹	1000
	AC-15/AC-14	h ⁻¹	1000
	DC-13	h ⁻¹	1000
• No-load switching frequency		h ⁻¹	10000
Dependence of the switching frequency z' on the operational current I' and operational voltage U' : $z' = z \cdot (I_e/I') \cdot (400 \text{ V}/U')^{1.5} \cdot 1/\text{h}$			

¹⁾ Snap-on auxiliary switch blocks: 6 A.

3RH, 3TH Contactor Relays

3RH14 latched contactor relays, 4-pole

Overview

AC and DC operation

IEC 60947, EN 60947 (VDE 0660).

The terminal designations comply with EN 50011.

The contactor coil and the coil of the release solenoid are both designed for uninterrupted duty.

The number of auxiliary contacts can be extended by means of auxiliary switch blocks (up to 4 poles).

RC elements, varistors diodes or diode assemblies can be fitted to both coils from the front for damping opening surges in the coil.

The contactor relay can also be switched on and released manually ([for minimum actuating times, see page 3/134](#)).

Overview**AC and DC operation**

IEC 60947 and EN 60947 (VDE 0660).

The 3TH42/3TH43 contactor relays are suitable for use in any climate. They are finger-safe according to EN 50274.

Terminal designations according to EN 50011

In terms of their terminal designations, identification numbers and identification letters, the 3TH42/3TH43 contactor relays conform to the standard EN 50011 for "Specific contactor relays".

Function**Contact reliability**

High contact stability at low voltages and currents thanks to the use of moving double-break contacts, suitable for solid-state circuits with currents ≥ 1 mA for voltages at 17 V.

Make-before-break contacting

The 3TH42/3TH43 contactor relays are available in versions with make-before-break contacting (make-before-break between 1 NO and 1 NC).

The make-before-break time is approximately 1 ms. This is not sufficient to cause another contactor to close. If the make-before-break conducting paths are connected in series, a fleeting contact element is created; the wiping time is approximately 1 ms.



Surge suppression

The 3TH42/3TH43 contactors can be equipped with RC elements, varistors, diodes or diode assemblies (combination of a diode and a Zener diode) for damping opening surges. The surge suppressors can be mounted directly on the coil (see "Accessories").

Note:

The OFF-delay times of the NO contacts and the ON-delay times of the NC contacts increase if the contactor coils are damped against voltage peaks (noise suppression diode 6 to 10 times; diode assembly 2 to 6 times, varistor +2 to 5 ms).

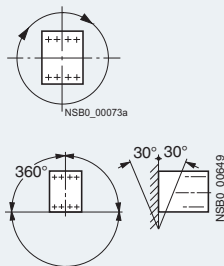
Technical specifications

Contactors	Type	3TH42/3TH43
Permissible mounting position		
The contactors are designed for operation on a vertical mounting surface.	• AC operation	 NSB0_00073a NSB0_00649
	• DC operation	
Upright mounting position	• AC and DC operation	 NSB0_00477a Special version required

Positively-driven operation in contactor relays with 8 and 10 contacts**3TH42/3TH43:**

Yes, the contactor relays comply with the conditions for positively-driven operation acc. to:

- ZH 1/457
- EN 60947-5-1, Appendix L
- SUVA

Explanations:

There is positively-driven operation if it is ensured that the NC and NO contacts cannot be closed at the same time.

ZH1/457

Safety rules for control units on power-operated presses in the metal-working industry.

EN 60947-5-1, Appendix L

Low-voltage controlgear, control equipment, and switching elements. Special requirements for positively-driven contacts

SUVA

Accident prevention regulations of the "Schweizer Unfallverhütungsanstalt" (Swiss Institute for Accident Insurance)

3RH, 3TH Contactor Relays

3TH4 contactor relays, 8- and 10-pole

Contactors

Type

3TH42/3TH43

Contact endurance for AC-15/AC-14 and DC-13 utilization categories

The contact endurance is mainly dependent on the breaking current. It is assumed that the operating mechanisms are switched randomly, i. e. not synchronized with the phase angle of the supply system. If magnetic circuits other than the contactor coil systems or solenoid valves are present, e.g. magnetic brakes, protective measures for the load circuits are necessary. RC elements and freewheel diodes would be suitable as protective measures.

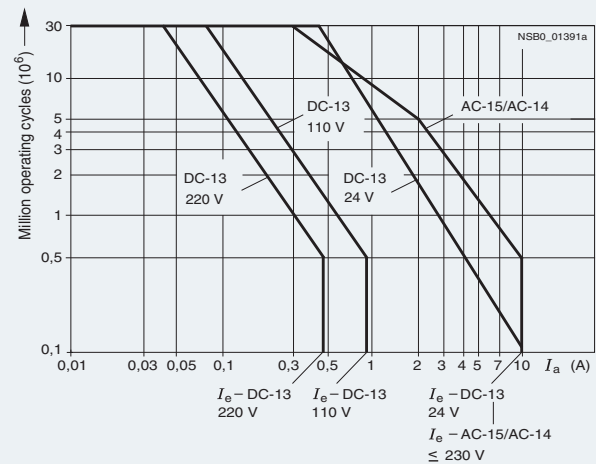

Ⓢ and Ⓜ ratings

Basic units

Rated control supply voltage U_s

Max. 600 V AC, 230 V DC (acc. to UL 240 V DC)

Rated voltage

600 V AC, 600 V DC

Switching capacity

A 600, P 600

General data

Mechanical endurance	Basic units	Oper-ating cycles	30 million
Rated insulation voltage U_i (degree of pollution 3)		V	690
Rated impulse withstand voltage U_{imp}		kV	8
Protective separation between the coil and the main contacts acc. to EN 60947-1, Appendix N		V	Up to 500
Permissible ambient temperature	• During operation • During storage	°C	-25 ... +55 -55 ... +80
Degree of protection acc. to EN 60947-1, Appendix C			IP20
Shock resistance			
• Rectangular pulse	- AC operation - DC operation	g/ms g/ms	7.7/5 and 4.4/10 9.3/5 and 5.4/10
• Sine pulse	- AC operation - DC operation	g/ms g/ms	12/5 and 6.8/10 14.7/5 and 8.5/10

Conductor cross-sections

- Solid
- Finely stranded with end sleeve
- Terminal screw

mm²
mm²

Ⓢ Screw terminals

2 x (0.5 ... 1)¹⁾; 2 x (1 ... 2.5)¹⁾; 1 x 4
 2 x (0.75 ... 2.5)
 M3.5

Short-circuit protection

(weld-free protection at $I_k \geq 1$ kA)

• Fuse links, gL/gG operational class	- LV HRC Type 3NA	A	16
	- DIAZED Type 5SB	A	16
	- NEOZED Type 5SE, quick	A	20
• Miniature circuit breaker	- C Characteristic	A	16
	- B Characteristic	A	16

¹⁾ If two different conductor cross-sections are connected to one clamping point, both cross-sections must lie in the range specified. If identical cross-sections are used, this restriction does not apply.

Contactors	Type	3TH42/3TH43	
Control			
Magnetic coil operating range			
AC operation			0.8 ... 1.1 x U_s ¹⁾
DC operation (except 24 V)			0.8 ... 1.1 x U_s
• At 24 V DC			0.8 ... 1.2 x U_s
Power consumption of the magnetic coils (when coil is cold and 1.0 x U_s)			
AC operation, 50 Hz, standard version			
• Closing	VA/p.f.	68/0.82	
• Closed	VA/p.f.	10/0.29	
AC operation, 50/60 Hz, standard version			
• Closing, 50 Hz	VA/p.f.	77/0.81	
• Closed, 50 Hz	VA/p.f.	11/0.28	
• Closing, 60 Hz	VA/p.f.	71/0.75	
• Closed, 60 Hz	VA/p.f.	9/0.27	
AC operation, 50 Hz, USA/Canada			
• Closing	VA/p.f.	68/0.82	
• Closed	VA/p.f.	10/0.29	
AC operation, 60 Hz, USA/Canada			
• Closing	VA/p.f.	75/0.76	
• Closed	VA/p.f.	9.4/0.29 ... 0.3	
AC operation, 50 Hz, standard version			
• Closing	VA/p.f.	80/0.8	
• Closed	VA/p.f.	10.7/0.29	
AC operation, 60 Hz, standard version			
• Closing	VA/p.f.	75 ... 90/0.73	
• Closed	VA/p.f.	8.5 ... 10.7/0.29 ... 0.3	
DC operation up to 250 V	Closing = Closed	W	6.2
Permissible residual current of the electronics (with 0 signal)			
For AC operation			$\leq 8 \text{ mA} \times (220 \text{ V}/U_s)$
For DC operation			$\leq 1.25 \text{ mA} \times (220 \text{ V}/U_s)$
Operating times²⁾			
Total break time = OFF-delay + arcing time (the values apply up to and including 20 % undervoltage, 10 % overvoltage, and with the coil in the cold state and at operating temperature)			
<u>AC operation</u>			
Closing			
• ON-delay NO	ms	8 ... 35	
• OFF-delay NC	ms	6 ... 20	
Opening			
• OFF-delay NO	ms	4 ... 18	
• ON-delay NC	ms	5 ... 30	
Arcing time	ms	10	
<u>DC operation</u>			
Closing			
• ON-delay NO	ms	20 ... 170	
• OFF-delay NC	ms	18 ... 110	
Opening			
• OFF-delay NO	ms	10 ... 25	
• ON-delay NC	ms	15 ... 30	
Arcing time	ms	10	
Operating times²⁾ at 1.0 x U_s			
<u>AC operation</u>			
Closing			
• ON-delay NO	ms	10 ... 25	
• OFF-delay NC	ms	7 ... 20	
Opening			
• OFF-delay NO	ms	5 ... 18	
• ON-delay NC	ms	7 ... 20	
<u>DC operation</u>			
Closing			
• ON-delay NO	ms	30 ... 70	
• OFF-delay NC	ms	28 ... 65	
Opening			
• OFF-delay NO	ms	10 ... 20	
• ON-delay NC	ms	15 ... 25	

¹⁾ Coils for USA, Canada and Japan: 0.85 ... 1.1 U_s at 60 Hz.

²⁾ The OFF-delay of the NO contact and the ON-delay of the NC contact are increased if the contactor coils are attenuated against voltage peaks (noise suppression diode 6 to 9 times; diode assemblies 2 to 6 times, varistor +2 to 5 ms).

3RH, 3TH Contactor Relays

3TH4 contactor relays, 8- and 10-pole

Contactor	Type	3TH42/3TH43	
Load side			
Rated operational currents I_e			
AC-12	A		16
AC-15/AC-14 for rated operational voltage U_e			
	230 V	A	10
	400 V	A	6
	500 V	A	4
	690 V	A	2
DC-12, for rated operational voltage U_e			
• 1 conducting path	Up to 48 V	A	10
	110 V	A	2.1
	220 V	A	0.8
	440 V	A	0.6
	600 V	A	0.6
• 2 conducting paths in series	Up to 48 V	A	10
	110 V	A	10
	220 V	A	1.6
	440 V	A	0.8
	600 V	A	0.7
• 3 conducting paths in series	Up to 48 V	A	10
	110 V	A	10
	220 V	A	10
	440 V	A	1.3
	600 V	A	1
DC-13, for rated operational voltage U_e			
• 1 conducting path	24 V	A	10
	48 V	A	5
	110 V	A	1
	220 V	A	0.45
	440 V	A	0.25
	600 V	A	0.2
• 2 conducting paths in series	24 V	A	10
	48 V	A	10
	110 V	A	2.5
	220 V	A	0.75
	440 V	A	0.5
	600 V	A	0.4
• 3 conducting paths in series	24 V	A	10
	48 V	A	10
	110 V	A	10
	220 V	A	2
	440 V	A	0.9
	600 V	A	0.8
Rated power of induction motors			
Acc. to utilization category AC-2 and AC-3, 50 Hz			
	230/220 V	kW	2.4
	400/380 V	kW	4
	500 V	kW	4
	690/660 V	kW	4
Switching frequency z^1			
Operating cycles per hour during normal duty for utilization category			
	AC-12/DC-12	h ⁻¹	1000
	AC-2	h ⁻¹	500
	AC-3	h ⁻¹	1000
	AC-15/AC-14	h ⁻¹	3600
	DC-13	h ⁻¹	3600
	No-load switching frequency	h ⁻¹	10000

¹⁾ Dependence of the switching frequency z' on the operational current I' and operational voltage U' : $z' = z \cdot (I_e/I') \cdot (400 \text{ V}/U')^{1.5} \cdot 1/\text{h}$.

3TH2 contactor relays, 4- and 8-pole

Overview**AC and DC operation**

IEC 60947 (VDE 0660).

The terminal designations comply with EN 50011.

3TH2 contactor relays

The 3TH2 contactor relays are suitable for use in any climate. The contactor relays with screw terminals are finger-safe according to EN 50274.

3TH27 latched contactor relays

The contactor coil and the coil of the release solenoid are both designed for uninterrupted duty.

RC elements, varistors diodes or diode assemblies can be fitted to both coils from the front for damping opening surges in the coil.

The contactor relay can also be switched on and released manually.

Design**3TH2 contactor relays****Version**

The 3TH20 contactors with 4 auxiliary contacts are available with SIGUT screw terminals, 6.3 mm x 0.8 mm flat connectors and solder pin connections.

The contactors with 6.3 mm x 0.8 mm flat connectors can be used in the plug-in base with solder pin connections for printed circuit boards. The contactor relays are coded and the plug-in base is codable in order to ensure non-interchangeability.

The 3TH22 contactor relays with 8 integrated contacts are available with screw terminals. The terminal designations are according to EN 50011.

Contact reliability

High contact stability at low voltages and currents, suitable for solid-state circuits with currents ≥ 1 mA at a voltage of 17 V and higher.

Auxiliary switch blocks

The contactor relays with 4 contacts with screw terminals relays can be expanded by up to four contacts by the addition of snap-on auxiliary switch blocks.

A cover (with unit labeling plate) must be removed from the front of the contactor for this purpose. The auxiliary switch block is then easy to mount. The auxiliary switch blocks can be removed again by unlocking them with a laterally arranged slide.

The contactor relays with screw terminals with 4 contacts according to EN 50011, with the identification number 40E, can be extended with 80E, 71E, 62E, 53E or 44E auxiliary switch blocks to obtain contactor relays with 8 contacts according to EN 50011. The identification numbers 80E, 71E, 62E, 53E or 44E on the coded auxiliary switch blocks apply to the complete contactors (see graphic on the right). These auxiliary switch blocks cannot be combined with contactor relays with identification number 31E and 33E.

All contactor relays with screw terminals with 4 contacts according to EN 50011, identification number 40E, 31E or 22E, can be extended with auxiliary switch blocks with identification number 40, 31, 22, 20, 11 or 02 to obtain contactor relays with 6 or 8 contacts according to EN 50005. The identification numbers on the auxiliary switch blocks apply only to the attached auxiliary switch blocks (see the graphic on the right).

3TH20 ...-0 contactor relays

Terminal designations according to EN 50011 and EN 50005

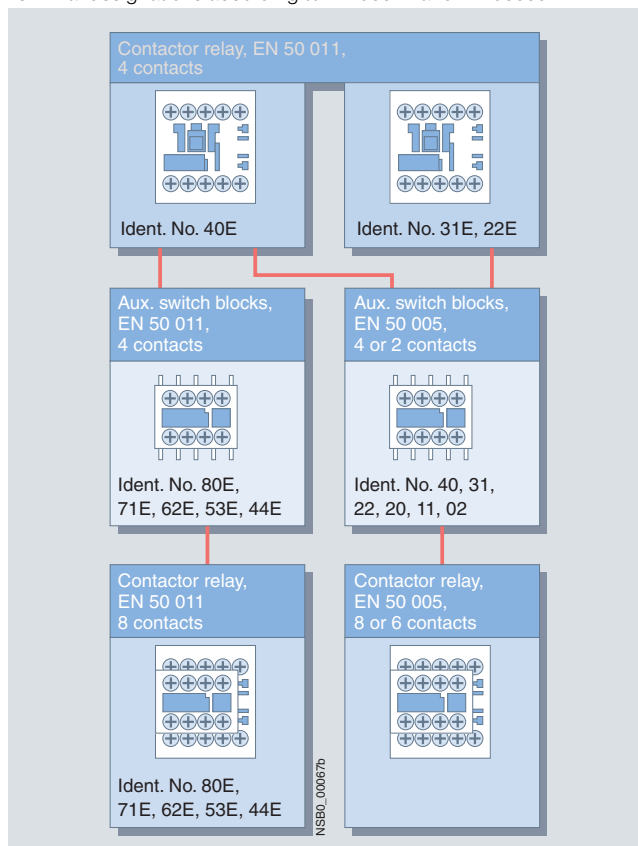
**Surge suppression**

RC elements, varistors, diodes or diode assemblies (combination of a diode and a Zener diode for short break times) can be plugged onto all contactors and auxiliary switch blocks with screw terminals from the front in order to damp opening surges in the coil. The unit labeling plate must be removed for this purpose.

It can be snapped onto the attached surge suppressor.

Residual current

The 3TX4 490-1J additional load module (see "Accessories") can be used by programmable logic controllers to increase the permissible residual current and to limit the residual voltage of semiconductor outputs.

This module ensures the safe opening of 3TH2/3TF2 contactors with direct control through 230 V AC semiconductor outputs. It is accommodated in the same enclosure as the 3TX4 490-3. surge suppressors and can be plugged into the contactor.

3RH, 3TH Contactor Relays

3TH2 contactor relays, 4- and 8-pole

Technical specifications

Contactor relays Type **3TH2**

Contact endurance for AC-15/AC-14 and DC-13 utilization categories

The contact endurance is mainly dependent on the breaking current. It is assumed that the operating mechanisms are switched randomly, i. e. not synchronized with the phase angle of the supply system.

If magnetic circuits other than the contactor coil systems or solenoid valves are present, e.g. magnetic brakes, protective measures for the load circuits are necessary. RC elements and freewheel diodes would be suitable as protective measures. Diagram legend:

I_e = Rated operational current

I_a = Breaking current

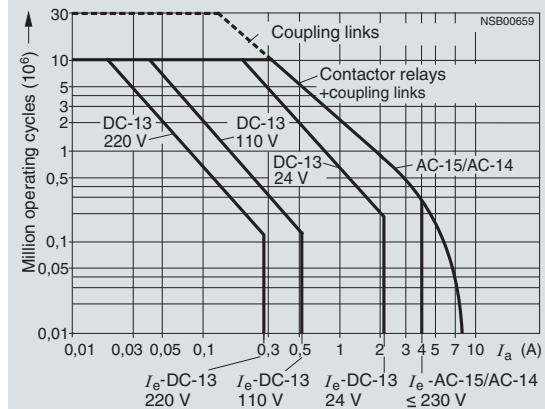

Type	Contactor relays		Auxiliary switch block
	3TH20 ..-....	3TH22 ..-....	3TX4
General data			
Permissible mounting position	AC and DC operation		Any
Mechanical endurance	<ul style="list-style-type: none"> • AC operation • DC operation 	Operating cycles	10 million 30 million
Rated insulation voltage U_i (degree of pollution 3)			
• Screw terminals	V	690	500
• Flat connector 6.3 mm x 0.8 mm	V	500	--
• Solder pin connections	V	500	--
Rated impulse withstand voltage U_{imp} (degree of pollution 3)			
• Screw terminals	kV	8	6
• Flat connector 6.3 mm x 0.8 mm	kV	6	--
• Solder pin connections	kV	6	--
Protective separation between coil and contacts (acc. to EN 61140)	V	Up to 300	
Positively-driven operation of contacts in contactor relays			
3TH20: Yes , in the basic unit and the auxiliary switch block as well as between the basic unit and the snap-on auxiliary switch block (removable) acc. to: • ZH 1/457 • EN 60947-5-1, Appendix L	Explanations: There is positively-driven operation if it is ensured that the NC and NO contacts cannot be closed at the same time. ZH1/457 Safety rules for control units on power-operated presses in the metal-working industry. EN 60947-5-1, Appendix L Low-voltage controlgear, control equipment, and switching elements. Special requirements for positively-driven contacts SUVA Accident prevention regulations of the "Schweizer Unfallverhütungsanstalt" (Swiss Institute for Accident Insurance)		
3TH22: Yes , in the basic unit and the auxiliary switch block as well as between the basic unit and the snap-on auxiliary switch block (fixed) acc. to: • ZH 1/457 • EN 60947-5-1, Appendix L • SUVA			
Permissible ambient temperature ¹⁾	<ul style="list-style-type: none"> • During operation • During storage 	°C	-25 ... +55 -55 ... +80
Degree of protection acc. to EN 60947-1 Appendix C	IP00 open IP20 for screw terminals IP40 coil assembly		
Touch protection acc. to EN 50274	Finger-safe for screw terminals		
Shock resistance			
• Rectangular pulse	- AC operation - DC operation	g/ms g/ms	7/5 and 4/10 10/5 and 6/10
• Sine pulse	- AC operation - DC operation	g/ms g/ms	9/5 and 6/10 13/5 and 8/10
Conductor cross-sections	2)		

1) Applies to 50/60 Hz coil
Operating range at 60 Hz: $0.85 \dots 1.1 \times U_s$;
at 50 Hz, $1.1 \times U_s$, side-by-side mounting and 100 % ON period the max. ambient temperature is +40 °C.

2) For conductor cross-sections see page 3/144.

3TH2 contactor relays, 4- and 8-pole



Contactor relays	Type	3TH2	
Short-circuit protection			
LV HRC 3NA, DIAZED 5SB, NEOZED 5SE Weld-free protection at $I_k \geq 1$ kA	A	6	
Control			
Magnetic coil operating range¹⁾		0.8 ... 1.1 x U_s	
Power consumption of the magnetic coils (when coil is cold and 1.0 x U_s)			
• AC operation, 50 Hz	Closing P.f. Closed P.f.	VA	15 0.41 6.8 0.42
• AC operation, 60 Hz	Closing P.f. Closed P.f.	VA	14.4 0.36 6.1 0.46
• AC operation, 50/60 Hz ¹⁾	Closing P.f. Closed P.f.	VA	16.5/13.2 0.43/0.38 8.0/5.4 0.48/0.42
• DC operation	Closing = Closed	W	3
Permissible residual current of the electronics (with 0 signal)			
	AC operation	mA	$\leq 3 \times (220 \text{ V}/U_s)$
	DC operation	mA	$\leq 1 \times (220 \text{ V}/U_s)$
Operating times at 0.8 ... 1.1 x U_s²⁾ Total break time = Opening delay + Arcing time Values apply with coil in cold state and at operating temperature for operating range			
• AC operation			
- Closing	ON-delay NO OFF-delay NC	ms	5 ... 20 4 ... 12
- Opening	OFF-delay NO ON-delay NC	ms	3 ... 24 3 ... 20
• DC operation			
- Closing	ON-delay NO OFF-delay NC	ms	16 ... 140 13 ... 40
- Opening	OFF-delay NO ON-delay NC	ms	3 ... 6 4 ... 10
• Arcing time		ms	10
Operating times at 1.0 x U_s²⁾			
• AC operation			
- Closing	ON-delay NO OFF-delay NC	ms	6 ... 17 5 ... 12
- Opening	OFF-delay NO ON-delay NC	ms	3 ... 24 5 ... 20
• DC operation			
- Closing	ON-delay NO OFF-delay NC	ms	18 ... 42 15 ... 26
- Opening	OFF-delay NO ON-delay NC	ms	3 ... 5 4 ... 10
Main circuit			
AC capacity			
Utilization category AC-12 Rated operational current I_e (at 60 °C)	A	10	
Utilization category AC-15 and AC-14 Rated operational current I_e for rated operational voltage U_e			
	230/220 V	A	4
	400/380 V	A	3
	500 V	A	2
	690/660 V	A	1

¹⁾ Applies to 50/60 Hz coil
Operating range at 60 Hz: 0.85 ... 1.1 x U_s ;
at 50 Hz, 1.1 x U_s , side-by-side mounting and 100 % ON period the max. ambient temperature is +40 °C.

²⁾ The OFF-delay of the NO contact and the ON-delay of the NC contact are increased if the contactor coils are attenuated against voltage peaks (noise suppression diode 6 to 10 times; diode assemblies 2 to 6 times, varistor +2 to 5 ms).

3RH, 3TH Contactor Relays

3TH2 contactor relays, 4- and 8-pole

Contactor relays	Type	3TH2	
Main circuit			
<i>Load rating with DC</i>			
Utilization category DC-12 Rated operational current I_e for rated operational voltage U_e	A		10
• 1 conducting path ¹⁾	Up to 24 V	A	4
	60 V	A	2
	110 V	A	1.1
	240/220 V	A	0.5
• 2 conducting paths in series	Up to 24 V	A	10
	60 V	A	10
	110 V	A	4
	240/220 V	A	2
• 3 conducting paths in series	Up to 24 V	A	10
	60 V	A	10
	110 V	A	6
	240/220 V	A	2.5
Utilization category DC-13 Rated operational current I_e for rated operational voltage U_e			
• 1 conducting path	Up to 24 V	A	2.1
	60 V	A	0.9
	110 V	A	0.52
	240/220 V	A	0.27
• 2 conducting paths in series	Up to 24 V	A	10
	60 V	A	3.5
	110 V	A	1.3
	240/220 V	A	0.9
• 3 conducting paths in series	Up to 24 V	A	10
	60 V	A	4.7
	110 V	A	3
	240/220 V	A	1.2
<i>Induction motors</i>			
Rated power of induction motors			
Acc. to utilization category	110 V	kW	0.2
AC-2 and AC-3	230/220 V	kW	0.55
	400/380 V	kW	1.1
	500 V	kW	1.5
	690/660 V	kW	1.5
<i>Switching frequency</i>			
Switching frequency z in operating cycles/hour			
Rated operation for utilization category			
Dependence of the switching frequency z' on the operational current I' and operational voltage U': $z' = z \cdot (I_e/I') \cdot (400 V/U')^{1.5} \cdot 1/h$	AC-12/DC-12	h ⁻¹	1000
	AC-2	h ⁻¹	500
	AC-3	h ⁻¹	1000
	AC-15/AC-14	h ⁻¹	1200
	DC-13	h ⁻¹	1200
No-load switching frequency		h ⁻¹	10000
Conductor cross-sections			
Main and auxiliary conductors		 Screw terminals	
• Solid	mm ²	2 x (0.5 ... 2.5)	
• Finely stranded with end sleeve	mm ²	2 x (0.5 ... 1.5)	
• Terminal screw		M3	
		 Flat connectors	
• Finely stranded		0.5 ... 1	
When using a plug-in sleeve	- 6.3 ... 1 - 6.3 ... 2.5	mm ² mm ²	1 ... 2.5
		 Solder pin connections (only for printed circuit boards)	

¹⁾ Contact endurance 0.1×10^6 operating cycles.

3RH11 coupling relays for switching auxiliary circuits, 4-pole

Application

DC operation

IEC 60947 and EN 60947 (VDE 0660).

The 3RH11 coupling relays for switching auxiliary circuits are tailored to the special requirements of working with electronic controls.

The 3RH11 coupling relays cannot be extended with auxiliary switch blocks.







Function

No auxiliary switch blocks can be snapped onto 3RH11 coupling relays.

Coupling relays have a low power consumption, an extended magnetic coil operating range and an integrated surge suppressor for damping opening surges (exceptions: 3RH11 ...-HB40 and 3RH11 ...-MB40.-0KT0).

Technical specifications

All technical specifications not mentioned in the table below are identical to those of the 3RH11 contactor relays (see page 3/132).
The size S00 coupling relays (3RH11) cannot be extended with auxiliary switch blocks.

Contactor type Size	3RH11 ...-HB40 S00	3RH11 ...-JB40 S00	3RH11 ...-KB40 S00
Magnetic coil operating range	0.7 ... 1.25 x U_s		
Power consumption of the magnetic coil (for cold coil) Closing = Closed			
At $U_s = 17\text{ V}$	W	1.2	
At $U_s = 24\text{ V}$	W	2.3	
At $U_s = 30\text{ V}$	W	3.6	
Permissible residual current Of the electronics for 0 signal	< 10 mA x (24 V/ U_s)		
Overvoltage configuration of the magnetic coil	No overvoltage damping 	With diode 	With varistor 
Operating times			
• Closing at 17 V			
- ON-delay NO	ms	40 ... 120	
- OFF-delay NC	ms	30 ... 70	
• At 24 V			
- ON-delay NO	ms	30 ... 60	
- OFF-delay NC	ms	20 ... 40	
• At 30 V			
- ON-delay NO	ms	20 ... 50	
- OFF-delay NC	ms	15 ... 30	
• Closing at 17 ... 30 V			
- OFF-delay NO	ms	7 ... 17	7 ... 17
- ON-delay NC	ms	22 ... 30	60 ... 70
Upright mounting position	Request required		
Contactor type Size	3RH11 ...-MB40-0KT0 S00	3RH11 ...-VB40 S00	3RH11 ...-WB40 S00
Magnetic coil operating range	0.85 ... 1.85 x U_s		
Power consumption of the magnetic coil (for cold coil) Closing = Closed at $U_s = 24\text{ V}$	W	1.4	
Permissible residual current Of the electronics for 0 signal	< 8 mA x (24 V/ U_s)		
Overvoltage configuration of the magnetic coil	Diode, varistor or RC element, attachable 	Built-in diode 	Built-in varistor 
Operating times of the coupling relays			
• Closing at 20.5 V			
- OFF-delay	ms	110 ... 20	
- ON-delay	ms	120 ... 30	
• At 24 V			
- ON-delay NO	ms	25 ... 90	
- OFF-delay NC	ms	15 ... 80	
• At 44 V			
- OFF-delay	ms	50 ... 10	
- ON-delay	ms	60 ... 15	
• Closing at 17 ... 30 V			
- OFF-delay NO	ms	5 ... 20	5 ... 20
- ON-delay NC	ms	10 ... 30	30 ... 90
Upright mounting position	Request required		

3RT Coupling Relays

3RT10 coupling relays (interface), 3-pole, 3 ... 11 kW

Application

DC operation

IEC 60947, EN 60947 (VDE 0660).

The 3RT10 coupling relays for switching motors are tailored to the special requirements of working with electronic controls.

The 3RT10 1. coupling relays cannot be extended with auxiliary switch blocks.

Two single-pole auxiliary switch blocks can be fitted to the 3RT10 2. coupling relays.

Function





Coupling relays have a low power consumption, an extended operating range of the magnetic coil and an integrated surge suppressor for damping opening surges (exceptions: 3RT10 1.-1HB4. and 3RT10 1.-.MB4.-0KT0).

Technical specifications

All technical specifications not mentioned in the table below are identical to those of the 3RT10 contactors for switching motors (see page 3/20).

The 3RT10 1. coupling relays cannot be extended with auxiliary switch blocks.



Two single-pole auxiliary switch blocks can be fitted to the 3RT10 2. coupling relays (see "Accessories").

Contactor	Type Size		3RT10 1.-.HB4. S00	3RT10 1.-.JB4. S00	3RT10 1.-.KB4. S00	3RT10 2.-.KB4. S0
General data						
Mechanical endurance		Operating cycles	30 million			10 million
Protective separation between the coil and the main contacts acc. to EN 60947-1, Appendix N		V	400			
Control						
Magnetic coil operating range			0.7 ... 1.25 x U_s			
Power consumption of the magnetic coil (for cold coil) Closing = Closed		At U_s	17 V W	1.2		2.1
			24 V W	2.3		4.2
			30 V W	3.6		6.6
Permissible residual current Of the electronics (for 0 signal)			< 10 mA x (24 V/ U_s)			< 6 mA x (24 V/ U_s)
Overvoltage configuration of the magnetic coil			No overvoltage damping 	With diode 	With varistor 	With varistor 
Operating times of the coupling relays						
• Closing						
- At 17 V	ON-delay NO	ms	40 ... 120			93 ... 270
	OFF-delay NC	ms	30 ... 70			83 ... 250
- At 24 V	ON-delay NO	ms	30 ... 60			64 ... 87
	OFF-delay NC	ms	20 ... 40			55 ... 78
- At 30 V	ON-delay NO	ms	20 ... 50			53 ... 64
	OFF-delay NC	ms	15 ... 30			45 ... 56
• Opening at 17... 30 V						
	OFF-delay NO	ms	7 ... 17	40 ... 60	7 ... 17	18 ... 19
	ON-delay NC	ms	22 ... 30	60 ... 70	22 ... 30	24 ... 25

3RT Coupling Relays

3RT10 coupling relays (interface),
3-pole, 3 ... 11 kW

All technical specifications not mentioned in the table below are identical to those of the 3RT10 contactors for switching motors (see page 3/20).
The 3RT10 1. coupling relays cannot be extended with auxiliary switch blocks.
Power consumption of the coils 1.4 W at 24 V.

Contactors	Type Size		3RT10 1.-1MB4.-0KT0 S00	3RT10 1.-1VB4. S00	3RT10 1.-1WB4. S00
General data					
Mechanical endurance		Oper- ating cycles	30 million		
Protective separation between the coil and the main contacts acc. to EN 60947-1, Appendix N		V	400		
Control					
Power consumption of the magnetic coil (for cold coil) Closing = Closed		At U_s 24 V W	1.4		
Permissible residual current, upright mounting position			On request		
Overvoltage configuration of the magnetic coil			No overvoltage damping 	With diode 	With varistor 
Operating times of the coupling relays					
• Closing					
- At 20.5 V	ON-delay NO	ms	40 ... 130		
	OFF-delay NC	ms	40 ... 125		
- At 24 V	ON-delay NO	ms	40 ... 100		
	OFF-delay NC	ms	30 ... 90		
- At 44 V	ON-delay NO	ms	20 ... 30		
	OFF-delay NC	ms	15 ... 25		
• Opening					
	OFF-delay NO	ms	9 ... 12	45 ... 65	10 ... 15
	ON-delay NC	ms	12 ... 16	52 ... 72	15 ... 20

3TX7, 3RS18 Coupling Relays

3TX7 Coupling Relays, Narrow Design

Relay couplers

Design

Installation instructions

Snap-on mounting is possible on horizontal and vertical standard mounting rails. In the case of vertical standard mounting rails and closely mounted units, the maximum permissible ambient temperature $T_U = 40\text{ °C}$. Any service position is possible.

If the coupling elements are operated continuously 24 hours per day (100 % ON period) at the maximum permissible rated control supply voltage and the maximum permissible ambient temperature, it is recommended that no similar equipment or other units that generate heat are placed directly adjoining the coupling elements because this can reduce the endurance of the couplers.

A distance $> 10\text{ mm}$ to the right and left of the coupling link reduces the risk of a premature failure under these operating conditions.

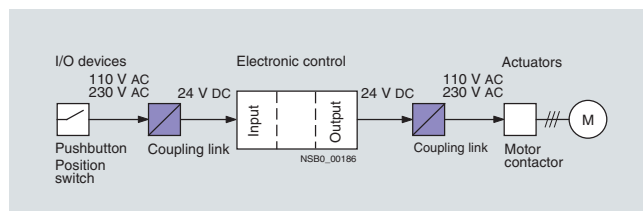

Function

Surge suppression

The coupling links have been tested with 1×10^5 operating cycles at AC-15 operation with the values specified in the Technical specifications.

If inductive loads are connected in parallel, the endurance of the relay couplers can be increased.

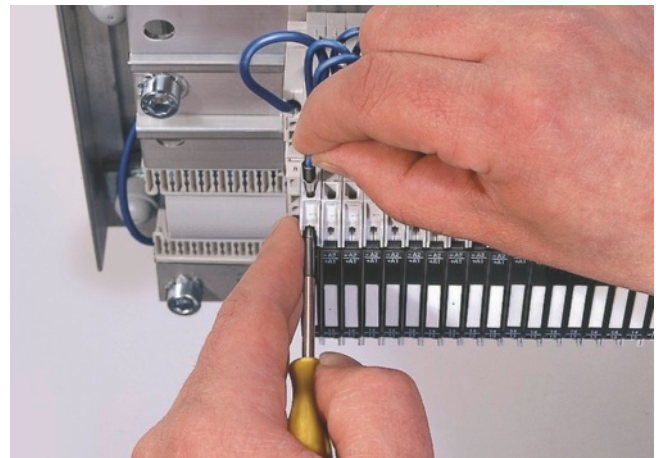

Note:

If capacitive loads without series resistors are switched, which limit temporary peak currents, microscopic welding of the relay contacts may result.



Connecting a cable to the spring-type terminals

Technical specifications

Type	3TX7 002/3TX7 003	
General data		
Rated insulation voltage U_i (degree of pollution 3)	V	300
Protective separation for relay couplers ¹⁾ Between the coil and the contacts acc. to EN 60947-1, Appendix N	V	Up to 300 AC
Degree of protection	<ul style="list-style-type: none"> • Connections for relay couplers • Enclosure 	IP20 IP30
Short-circuit protection acc. to IEC 60947-5-1 (weld-free protection at $I_k \geq 1\text{ kA}$) Fuse links, gL/gG operational class	A	4
Permissible ambient temperature	<ul style="list-style-type: none"> • During operation • During storage 	°C -25 ... +60 °C -40 ... +80
Conductor cross-sections		
<ul style="list-style-type: none"> • Solid • Finely stranded with or without end sleeve • Terminal screw Corresponding opening tool For 3TX7 003:	mm ² mm ²	 Screw terminals 1 x (0.25 ... 4) 1 x (0.5 ... 2.5) M3 Screwdriver, 3.5 mm x 0.5 mm (8WA2 804)
		 Spring-type terminals 1 x (0.08 ... 2.5) 1 x (0.25 ... 1.5) Screwdriver, 3.5 mm x 0.5 mm (8WA2 803)

¹⁾ For 3TX7 00.-1FB02, no protective separation according to EN 61140.

3TX7, 3RS18 Coupling Relays

3TX7 Coupling Relays, Narrow Design

Relay couplers

Type	3TX7 002-/3TX7 003-	1AB02	1AB00	1BB00	1FB02	1CB00	2AB00	2AE00	1BF00 2BF02	2AF00	2AF05	
Control side												
Operating range		0.8 ... 1.25 x U_s						0.8 ... 1.1 x U_s				
Power consumption at U_s	W	0.75	0.75	0.75	1.2	1.2	0.75	0.75	1.2	1.2	1.2	
Release voltage	%	≥ 10										
Max. permissible cable length (min. cross-section: 0.75 mm ²)	AC DC	m m	300 2000	300	300	300	300	300	15	7	7	350
Permissible residual current of the electronics (with 0 signal)		mA	2	2	2	2	4	2	0.4	0.35	0.35	4
Operating times at U_s	• ON-delay • OFF-delay	ms ms	< 8 < 10									
Function display			LED yellow									

Type	3TX7 002/3TX7 003										
Load side											
Rated currents¹⁾											
Continuous thermal current I_{th}		A	6								
Rated operational currents I_e											
Acc. to utilization categories (EN 60947) (3TX7 002-1CB00: AC-15, $I_e = 2$ A)											
• AC-15	- At 24 V - At 110 V - At 230 V	A A A	3 3 3								
• DC-13	- At 24 V - At 110 V - At 230 V	A A A	1 0.2 0.1								
Switching current With resistive load to VDE 0435 (relay standard) and EN 60947											
• AC-12	- At 24 V - At 110 V - At 230 V	A A A	6 6 6								
• DC-12	- At 24 V - At 110 V - At 230 V	A A A	6 0.2 0.2								
Switching voltage	AC/DC	V	24 ... 250								
• Min. contact load for 3TX7 00...02		mA	1 V, 0.1 AC/DC								
Mechanical endurance		Operating cycles	20 x 10 ⁶								
Electrical endurance at I_e		Operating cycles	1x10 ⁵								
Switching frequency		Operating cycles 1/h	5000								
Contact material for 3TX7 00...02			Ag/Ni 0.15 hard gold-plated								
Power limit hard gold-plating for 3TX7 00...02											
• Voltage		V	30								
• Current		mA	20								

¹⁾ Capacitive loads can result in micro-weldings on the contacts.



Note:

If inductive loads are connected in parallel, the endurance of the relay couplers can be increased.

3TX7, 3RS18 Coupling Relays

3TX7 Coupling Relays, Narrow Design

Relay couplers

Type	3TX7 004/3TX7 005				
General data					
Rated insulation voltage U_i (degree of pollution 3)	V	300			
Protective separation for relay couplers Between the coil and the contacts acc. to EN 60947-1, Appendix N	V	Up to 300 AC			
Degree of protection	<ul style="list-style-type: none"> • Terminals • Enclosure 	IP20 IP30			
Short-circuit protection acc. to IEC 60947-5-1 (weld-free protection at $I_k \geq 1$ kA) Fuse links, gL/gG operational class	A	4			
Permissible ambient temperature	<ul style="list-style-type: none"> • During operation • During storage 	°C °C	-25 ... +60 -40 ... +80		
Conductor cross-sections					
For 3TX7 004:			Screw terminals		
<ul style="list-style-type: none"> • Solid • Finely stranded without end sleeve • Finely stranded with end sleeve • Terminal screws 	mm ² mm ² mm ²		1 x (0.25 ... 4) 1 x (0.5 ... 2.5) 1 x (0.5 ... 2.5) M3		
For 3TX7 005:			Spring-type terminals		
<ul style="list-style-type: none"> • Solid or finely stranded • Finely stranded with end sleeve 	mm ² mm ²		1 x (0.08 ... 2.5) 1 x (0.25 ... 1.5)		
Control side					
Operating range	<ul style="list-style-type: none"> • At $U_s = 24$ V AC/DC • At $U_s = 110$ V and 230 V AC/DC 		0.7 ... 1.25 x U_s 0.8 ... 1.1 x U_s		
Power consumption at U_s			0.5 W; 3TX7 00...05: 1 W at 230 V DC/6 VA at 230 V AC		
Permissible residual current of the electronics (for 0 signal)	<ul style="list-style-type: none"> • Width 6.2 mm • $U_s = 24$ V • $U_s > 24$ V • From 12.5 mm width 	mA mA mA	2 0.5 2.5		
	Exceptions: 3TX7 00.-1BF05	mA mA	5 ($U_s = 230$ V AC) 0.5 ($U_s = 230$ V DC)		
Operating times at U_s	<ul style="list-style-type: none"> • ON-delay • OFF-delay 	ms ms	< 8 < 15		
Function display			LED yellow		
Type					
	3TX7 004/3TX7 005	-1.F00 -2ME02 -2MF02	-1.B.. -2MB02	-1BF05	
Max. permissible cable length (min. conductor cross-section: 0.75 mm ²)	AC DC	m m	40 2000	400 2000	350 2000

3TX7, 3RS18 Coupling Relays

3TX7 Coupling Relays, Narrow Design

Relay couplers

Type	3TX7 00.-1A/-1B/-1C/-1G/-1H/-1L		3TX7 00.-.M	
Load side				
Rated operational currents I_e ¹⁾				
• Continuous thermal current I_{th}		A	6	
• Rated operational current I_e acc. to utilization categories (EN 60947)				
- AC-15	At 24 V	A	3	2
	At 110 V	A	3	2
	At 230 V	A	3	2
- DC-13	At 24 V	A	1	
	At 110 V	A	0.2	
	At 230 V	A	0.1	
Switching current with resistive load to VDE 0435 (relay standard) and VDE 0660				
- AC-12	At 24 V	A	6	
	At 110 V	A	6	
	At 230 V	A	6	
- DC-12	At 24 V	A	6	
	At 110 V	A	0.3	
	At 230 V	A	0.2	
Power limit for hard gold-plating				
• Voltage		V	30	
• Current		mA	20	
Switching voltage AC/DC V 17 ... 250				
Min. switching voltage (reliability 1 ppm) ²⁾				
• Standard contact			17 V DC/5 mA	
• Hard gold-plated contacts			5 V DC/1 mA	
Endurance				
• Mechanical		Operating cycles	20 x 10 ⁶	
• Electrical (at I_e)		Operating cycles	1 x 10 ⁶	0.5 x 10 ⁶
Switching frequency Operating cycles 1/h 5000				

¹⁾ Capacitive loads can result in micro-weldings on the contacts.

²⁾ 1 ppm = 1st fault in one million operating cycles.

Note:

If inductive loads are connected in parallel, the endurance of the relay couplers can be increased.

3TX7, 3RS18 Coupling Relays

3TX7 Coupling Relays, Narrow Design

Relay couplers with plug-in design

Design

Coupling links are used to connect signals to and from a PLC. The plug-in relays enable the relay to be replaced at the end of its service life without detaching the wiring.

For easy linking of the signals, each terminal can be jumpered using an external connecting comb.

Technical specifications

Type	3TX7 01.-1	
General data		
Rated insulation voltage U_i (degree of pollution 2)	V	300
Protective separation Between the coil and the contacts acc. to EN 60947-1, Appendix N	V	Up to 300 AC
Degree of protection	<ul style="list-style-type: none"> Enclosure Relays 	IP20 IP40
Short-circuit protection acc. to IEC 60947-5-1 (weld-free protection at $I_k \geq 1$ kA) Fuse links, gL/gG operational class	A	4
Permissible ambient temperature	<ul style="list-style-type: none"> During operation During storage 	<ul style="list-style-type: none"> °C °C -25 ... +55 -40 ... +80
Conductor cross-sections		
<ul style="list-style-type: none"> Solid Finely stranded with or without end sleeve Terminal screw Permissible opening tool	mm ² mm ²	 Screw terminals 1 x (0.5 ... 2.5) 1 x (0.5 ... 1.5) M2.5 Screwdriver with blade width 3.0 mm x 0.5 mm

Type	3TX7 01.-1.H	3TX7 01.-1.B	3TX7 01.-1.E	3TX7 01.-1.F
Control side				
Operating range	0.9 ... 1.1 U_s	0.7 ... 1.25 U_s	0.8 ... 1.1 U_s	0.8 ... 1.1 U_s
Power consumption at U_s (24 V/115 V/230 V)	< 0.5/0.5/1			
Release voltage	10 of U_s			
Max. permissible cable length (min. conductor cross-section: 0.75 mm ²)				
<ul style="list-style-type: none"> AC DC 	m m	100 2000	70 800	40 800
Permissible residual current of the electronics (for 0 signal)	mA	1	2	0.3
Operating times at U_s				
<ul style="list-style-type: none"> ON-delay OFF-delay 	ms ms	< 6 < 6	< 7 < 7	< 8 < 20
Function display	LED yellow			
Protection circuit	<ul style="list-style-type: none"> DC AC 	Freewheel diode + Reverse polarity protection Rectifier bridge		

Type	3TX7 01.-1		
Load side			
Rated currents¹⁾			
<ul style="list-style-type: none"> Continuous thermal current I_{th} Rated operational currents I_e <ul style="list-style-type: none"> AC-15 <ul style="list-style-type: none"> At 24 V At 110 V At 230 V DC-13 <ul style="list-style-type: none"> At 24 V At 110 V At 230 V 	A A A A A A A	5 3 3 3 1 0.2 0.1	
Switching voltage	AC/DC	V	24 ... 250
Min. contact load (reliability 1 ppm) ²⁾			17 V DC/5 mA 5 V DC/1 mA
Mechanical endurance	Operating cycles		20×10^6
Electrical endurance at I_e acc. to AC-15	Operating cycles		100000
Switching frequency	Operating cycles	1/h	5000

Note: If inductive loads are connected in parallel, the endurance of the relay couplers can be increased.

¹⁾ Capacitive loads can result in micro-weldings on the contacts.

²⁾ 1 ppm = 1st fault in one million operating cycles.

3TX7, 3RS18 Coupling Relays

3TX7 Coupling Relays, Narrow Design

Semiconductor couplers

Overview

AC and DC operation

EN 60664-1, EN 60947 and EN 50005; optocouplers:
EN 60747-5, IEC 61131-2 (programmable controllers).

In the coupling links in double-decker design, the connections are arranged on two levels; the units are extremely compact. Connection method: screw or spring-type terminals. For test purposes, versions are available with manual 0 automatic switches.

The input and output coupling links differ with regard to the positioning of the terminals and the LEDs. For equipment identification purposes, each coupling link has a blank labeling plate.

In accordance with the technical specifications of electronic systems, the coupling links have a lower power consumption.

Design

Installation instructions

Snap-on mounting is possible on horizontal and vertical standard mounting rails. In the case of vertical standard mounting rails and closely mounted units, the maximum permissible ambient temperature $T_U = 40\text{ °C}$. Any service position is possible.

If the coupling elements are operated continuously 24 hours per day (100 % ON period) at the maximum permissible rated control supply voltage and the maximum permissible ambient temperature, it is recommended that no similar equipment or other units that generate heat are placed directly adjoining the coupling elements because this can reduce the endurance of the couplers.

A distance $> 10\text{ mm}$ to the right and left of the coupling link reduces the risk of a premature failure under these operating conditions.

Optocouplers switch using semiconductors. These are not subject to wear; welding is not possible.

The 6.2 mm wide optocouplers have an opening in the right-hand side of the casing. They can, like relay couplers, be mounted side-by-side without gaps.

Function

Surge suppression

In the case of optocouplers, the contact element is a semiconductor. These are not subject to wear; so welding is not possible.

Note:

With semiconductors, the switching current is not dependent on the inductance of the load, i. e. the switching current for a DC-13 load is the same as that for an inductive DC-12 load. This means that coupling links with a semiconductor output are particularly suitable for inductive loads such as solenoid valves. It is not relevant to specify the number of operating cycles because this does not affect the endurance of the semiconductor provided it is not overheated.

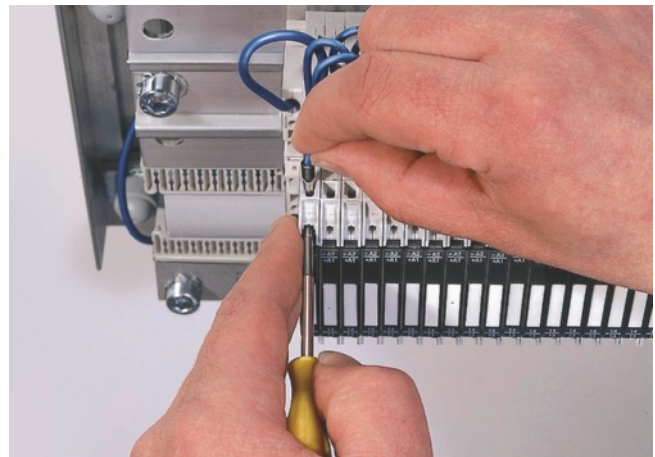

Connecting a cable to the spring-type terminals

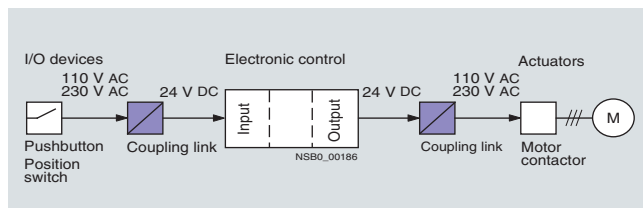

3TX7, 3RS18 Coupling Relays

3TX7 Coupling Relays, Narrow Design

Semiconductor couplers

Technical specifications

Type	3TX7 004-1.F.5	
General data		
<i>Derating diagram for 3TX7 002-3AB01 load current depending on the ambient temperature T_U</i>		
	Rated insulation voltage U_i (degree of pollution 3)	V 300
	Optoelectronic coupling element for protective separation Acc. to EN 60947-1, Appendix N	V
Permissible ambient temperature	°C	-25 ... +60
• During operation	°C	-40 ... +80
• During storage		
Conductor cross-sections		
• Solid	mm ²	1 x (0.25 ... 4)
• Finely stranded with or without end sleeve	mm ²	1 x (0.5 ... 2.5)
• Terminal screws		M3
		Screw terminals



Type	3TX7002-	3AB00	3AB01	4AB00	4AG00
Control side					
Operating range	V	17 ... 30 DC	11 ... 30 DC	17 ... 30 AC/DC	88 ... 264 AC
Control side power consumption					
	At 17 V DC	mA < 18	< 5	--	--
	At 24 V DC	mA < 20	< 7	--	--
	At 30 V DC	mA < 22	< 8.5	--	--
	At 17 V AC/DC	mA --	--	< 10	--
	At 24 V AC/DC	mA --	--	< 14	--
	At 30 V AC/DC	mA --	--	< 18	--
	At 88 V AC	mA --	--	--	< 9
	At 230 V AC	mA --	--	--	< 24
	At 264 V AC	mA --	--	--	< 28
Release voltage	V	> 5	> 8	> 5	> 40
Operating times					
• ON-delay	At 17 V DC	ms < 10	< 0.1	1	--
	At 24 V DC	ms < 10	< 0.1	1	--
	At 30 V DC	ms < 10	< 0.1	1	--
	At 17 V AC/DC	ms --	--	< 1	--
	At 24 V AC/DC	ms --	--	< 1	--
	At 30 V AC/DC	ms --	--	< 1	--
	At 88 V AC	ms --	--	--	< 18
	At 230 V AC	ms --	--	--	< 20
	At 264 V AC	ms --	--	--	< 22
• OFF-delay	At 17 V DC	ms < 10	< 0.1	< 18	--
	At 24 V DC	ms < 10	< 0.1	< 25	--
	At 30 V DC	ms < 10	< 0.1	< 30	--
	At 17 V AC/DC	ms --	--	< 18	--
	At 24 V AC/DC	ms --	--	< 25	--
	At 30 V AC/DC	ms --	--	< 30	--
	At 88 V AC	ms --	--	--	< 10
	At 230 V AC	ms --	--	--	< 20
	At 264 V AC	ms --	--	--	< 25
Function display		LED yellow	LED yellow	LED yellow	LED yellow
Max. permissible cable length (min. cond. cross-section: 0.75 mm ²)	AC	m --	--	1000	140
	DC	m 2000	2000	2000	--
Load side					
Switching current	A	1.8	1.5 (see derating diagram)	0.1	0.1
Short-time loading capacity					
	A	20	4	1	1
	ms	20	200	20	20
Contacts					
		1 NO, Triac	1 NO, transistor	1 NO, transistor	1 NO, transistor
Switching voltage¹⁾ (operating range)	• Effective AC 50/60 Hz • DC	V 48 ... 264	--	--	--
		--	≤ 60	≤ 30	≤ 30
Minimum load current		mA 60	--	--	--
Voltage drop conducting		V ≤ 1.5	≤ 1.1	≤ 1.7	≤ 0.3
Permissible residual current of the electronics (with 0 signal)		mA < 5	< 0.1	< 0.1	< 0.001
Switching frequency at I_e		Hz 1	1	5	5

¹⁾ Observe minimum switching voltage for 3TX7 002-3AB00.

3TX7, 3RS18 Coupling Relays

3TX7 Coupling Relays, Narrow Design

Semiconductor couplers

Type	3TX7 004/3TX7 005	
General data		
Rated insulation voltage U_i (degree of pollution 3)	V	300
Protective separation acc. to EN 60947-1, Appendix N for optocouplers	V	Up to 300
Permissible ambient temperature		
• During operation	°C	-25 ... +60
• During storage	°C	-40 ... +80
Conductor cross-sections		
For 3TX7 004		 Screw terminals
• Solid	mm ²	1 x (0.25 ... 4)
• Finely stranded without end sleeve	mm ²	1 x (0.5 ... 2.5)
• Finely stranded with end sleeve	mm ²	1 x (0.5 ... 2.5)
• Terminal screws		M3
Permissible opening tool		Screwdriver, 3.5 mm x 0.5 mm (8WA2 804)
For 3TX7 005		 Spring-type terminals
• Solid or finely stranded	mm ²	1 x (0.08 ... 2.5)
• Finely stranded with end sleeve	mm ²	1 x (0.25 ... 1.5)
Permissible opening tool		Screwdriver, 3.5 mm x 0.5 mm (8WA2 803)

Type	3TX7 004-/3TX7 005-	3AB04	3AC.4	3AC03	3PB54	4PG24
Control side						
Operating range	V	11 ... 30 DC				110 ... 230 AC/DC
Power consumption						
	• At 24 V DC	W	≤ 0.5	≤ 0.5	≤ 0.25	≤ 0.2
	• At 230 V AC	W	--	--	--	--
Release voltage	V	6	5	6	9	20
Permissible residual current of the electronics (for 0 signal)	mA	2.3	2.6	1.5	1.5	0.4
Operating times						
	• ON-delay	ms	2.5	0.3	10	0.3
	• OFF-delay	ms	8	4	10	0.3
Function display		LED yellow				
Max. permissible cable length (min. conductor cross-section: 0.75 mm ²)	m	1700	2000	2000	2000	40
Load side						
Switching voltage	V	10 ... 48 DC	10 ... 30 DC	24 ... 250 AC	10 ... 30 DC	10 ... 30 DC
Switching current	A	0.5	5	2	1.5	0.1
Short-time loading capacity						
	A	1.5	Short-circuit resistant ¹⁾	100	Short-circuit resistant ²⁾	0.2
	ms	20	--	20	--	3
Contacts		1 NO, transistor		1 NO, Triac	1 NO, transistor	
Minimum load current	mA	--	500 ³⁾	50	--	--
Voltage drop conducting	V	≤ 1	≤ 0.5	≤ 1.6	≤ 0.5	≤ 1.5
Leakage current of the electronics for 0 signal	mA	< 0.1	< 0.1	< 6	< 0.1	< 0.1
Switching frequency for resistive load	Hz	50	50	1	500	25

¹⁾ In the event of a short-circuit or overload, the semiconductor output switches off. In order to operate the device again, it must be temporarily disconnected from the power supply.

²⁾ In the event of a short-circuit or overload, the current is limited by the semiconductor output.

³⁾ If the current falls below the minimum load current, the built-in semiconductor detects an open circuit in the load circuit. The control must be temporarily switched off for resetting.

3TX7, 3RS18 Coupling Relays

3TX7 Coupling Relays, Narrow Design

Semiconductor couplers

Type	3TX7 004-/3TX7 005-		3PB74	3PG74
Control side				
Operating range		V	11 ... 30 DC	88 ... 253 AC/DC
Power consumption	<ul style="list-style-type: none"> • At 24 V DC • At 110 V DC • At 230 V AC 	W W W	0.2 -- --	-- 0.2 ≤ 1.5
Release voltage		V	6	25
Permissible residual current of the electronics (for 0 signal)		mA	1.2	1
Operating times	<ul style="list-style-type: none"> • ON-delay • OFF-delay 	ms ms	0.2 1.0	1.5 75
Function display			LED yellow	
Max. permissible cable length (min. conductor cross-section: 0.75 mm ²)		m	2000	40
Load side				
Switching voltage max.	<ul style="list-style-type: none"> • Min. • Max. 	V V	11 DC 30 DC	
Switching current		A	3	
Short-time loading capacity		A ms	Short-circuit resistant ¹⁾ --	
Contacts			1 NO, transistor	
Minimum load current		mA	--	
Voltage drop conducting		V	≤ 0.5	
Leakage current of the electronics for 0 signal		mA	0.1	
Switching frequency for resistive load		1/s	10	

¹⁾ In the event of a short-circuit or overload, the current is limited by the semiconductor output.

3TX7, 3RS18 Coupling Relays

3RS18 Coupling Relays with Industrial Housing

Relay couplers



Overview

The new 3RS18 coupling relays are couplers in the well-proven standard 22.5 mm timing relay enclosure. The series comprises relays with 1, 2 and 3 changeover contacts with screw and spring-type connections for combined voltages and wide voltage ranges.

Application

Typical applications are found wherever solid-state compatible contacts are required and equipment with a wide voltage range is implemented.

Technical specifications

Type	3RS1800	
General data		
Rated insulation voltage U_i degree of pollution 3	V	500
Protective separation acc. to EN 60947-1, Appendix N between the coil and the contacts and between the individual contacts.	V	300
Degree of protection acc. to EN 60529		
• Enclosure		IP20
• Cover		IP40
Permissible ambient temperature		
• During operation	°C	-25 ... +60
• During storage	°C	-40 ... +80
Permissible		Any
Shock resistance Half-sine acc. to IEC 60028-2-27	g/ms	15/11
Vibration resistance Acc. to IEC 60068-2-6	g/ms	10 ... 55/0.35
Electromagnetic compatibility (EMC) Tests acc. to basic specification		IEC 61000-6-2/IEC 61000-6-4
Conductor cross-sections		
		 Screw terminals
• Solid	mm ²	1 x (0.5 ... 4); 2 x (0.5 ... 2.5)
• Finely stranded with end sleeve	mm ²	2 x (0.5 ... 2.5)
• AWG cables, solid or stranded	mm ²	2 x (20 ... 14)
• Terminal screw		M3.5
• Tightening torque	Nm	0.8 ... 1.2
Corresponding opening tool		Standard screwdriver, size 2 or Pozidriv 2
		 Spring-type terminals
• Solid	mm ²	2 x (0.25 ... 1.5)
• Finely stranded without end sleeve	mm ²	2 x (0.25 ... 1.5)
• Finely stranded with end sleeve	mm ²	2 x (0.25 ... 1)
• AWG cables, solid or stranded	AWG	2 x (24 ... 16)
Corresponding opening tool		Screwdriver with 3 mm blade or 8WA2 807 opening tool
Control side		
Operating range		0.85 ... 1.1 x U_s
Rated power		
• Max. DC	W	1
• Max. AC	VA	8
Mains buffering		
• Depends on version	ms	5 ... 100
Max. permissible cable length		
330 pF/m AC	m	100
Min. cross-section: 0.75 mm ² DC	m	2000
• 1 CO - AC	m	200
- DC	m	1500
• 2 CO - AC	m	200
- DC	m	1500
• 3 CO - AC	m	200
- DC	m	1500
Permissible residual current Of the electronics (for 0 signal)	mA	2
Temporarily flowing capacitor charging currents On energizing supply voltage	mA	450 for $\leq 500 \mu\text{s}^1$
Function display		LED yellow

¹⁾ Note the short-circuit limitation for control with the semiconductor version!

3TX7, 3RS18 Coupling Relays

3RS18 Coupling Relays with Industrial Housing

Relay couplers

Type		3RS18 ..-....0	3RS18 ..-....1
Load side			
Continuous thermal current I_{th}	A	6	
Rated operational currents I_e			
• AC-15	- At 24 V - At 110 V - At 230 V - At 400 V	A A A A	3 3 3 3
• DC-13	- At 24 V - At 110 V - At 230 V	A A A	1 0.2 0.1
Switching current for resistive load			
• AC-12	- At 24 V - At 115 V - At 230 V - At 400 V	A A A A	5 5 5 5
• DC-12	- At 24 V - At 115 V - At 230 V	A A A	5 0.2 0.2
Switching voltage	• Max. AC • Max. DC	V V	400 250
Contact material		AgSnO ₂	AgNi 0.15 hard gold-plated
Min. contact load			
• Standard contact		17 V DC/5 mA at 1 ppm fault	--
• Hard gold-plated contacts		--	5 V DC/1 mA at 1 ppm fault
Endurance			
• Mechanical	Operating cycles		20 x 10 ⁶
• Electrical (at I_e)	Operating cycles		1 x 10 ⁶
Operating times			
• Max. ON-delay at U_s	ms		8 (for 3RS18 00-. .W0. < 30)
• Max. OFF-delay at U_s	ms		30 (for 3RS18 00-. .W0. < 150)
Switching frequency	Operating cycles 1/h		5000
Short-circuit protection	A		4
Weld-free protection with gL/gG operational class at $I_k \geq 1$ kA			

Overview

The LZX complete units and accessory parts previously available are no longer listed in this catalog. They can still be supplied however in limited quantities. In their place you will now find the new LZS types. LZS complete units are fully compatible with their predecessors, the LZX complete units. The LZX plug-in relays have not been changed and are used accordingly in both the LZS and the LZX series.

Due to differences in geometry the LED modules, plug-in bases, retaining brackets and labels can be combined and/or used in only the respective series, LZS or LZX.

List for converting from LZX to LZS plug-in relay couplers:

Complete units	
Previous Order No.	New Order No.
LZX:PT3A5L24	LZS:PT3A5L24
LZX:PT3A5R24	LZS:PT3A5R24
LZX:PT3A5S15	LZS:PT3A5S15
LZX:PT3A5T30	LZS:PT3A5T30
LZX:PT5A5L24	LZS:PT5A5L24
LZX:PT5A5R24	LZS:PT5A5R24
LZX:PT5A5S15	LZS:PT5A5S15
LZX:PT5A5T30	LZS:PT5A5T30
LZX:PT5B5L24	LZS:PT5B5L24
LZX:PT5B5R24	LZS:PT5B5R24
LZX:PT5B5S15	LZS:PT5B5S15
LZX:PT5B5T30	LZS:PT5B5T30
LZX:RT3A4L24	LZS:RT3A4L24
LZX:RT3A4R24	LZS:RT3A4R24
LZX:RT3A4S15	LZS:RT3A4S15
LZX:RT3A4T30	LZS:RT3A4T30
LZX:RT3B4L24	LZS:RT3B4L24
LZX:RT3B4R24	LZS:RT3B4R24
LZX:RT3B4S15	LZS:RT3B4S15
LZX:RT3B4T30	LZS:RT3B4T30
LZX:RT4A4L24	LZS:RT4A4L24
LZX:RT4A4R24	LZS:RT4A4R24
LZX:RT4A4S15	LZS:RT4A4S15
LZX:RT4A4T30	LZS:RT4A4T30
LZX:RT4B4L24	LZS:RT4B4L24
LZX:RT4B4R24	LZS:RT4B4R24
LZX:RT4B4S15	LZS:RT4B4S15
LZX:RT4B4T30	LZS:RT4B4T30

Prices for the new LZS series are lower than for the previous LZX series.

Note:

In addition the LZS series offers not only service-proven screw connections but also versions with plug-in terminals.

The following conversion list will help you to change over from the LZX types previously sold to the new LZS types. Please contact your regional adviser if you have any questions.

List for converting from LZX to LZS accessories for individual modules:

Accessories for individual modules	
Previous Order No.	New Order No.
LZX:MT28800	LZS:MT28800
LZX:MT78750	LZS:MT78750
LZX:PT16016	LZS:PT17024 ¹⁾ LZS:PT17021 ²⁾
LZX:PT16040	LZS:PT17040
LZX:PT78702	LZS:PT78720
LZX:PT78703	LZS:PT78730
LZX:PT78704	LZS:PT78740
LZX:PT78802	LZS:PT78722
LZX:PT78804	LZS:PT78742
LZX:RPMG0024	LZS:PTMG0024
LZX:RPMG0524	LZS:PTMG0524
LZX:RPMG0730	LZS:PTMG0730
LZX:RPML0024	LZS:PTML0024
LZX:RPML0524	LZS:PTML0524
LZX:RPML0730	LZS:PTML0730
LZX:RPMT00A0	LZS:PTMT00A0
LZX:RPMU0548	LZS:PTMU0524
LZX:RPMU0730	LZS:PTMU0730
LZX:RT16016	LZS:RT17016
LZX:RT78625	LZS:RT78725
LZX:RT78626	LZS:RT78726
LZX:RY16040	LZS:RT17040

¹⁾ LZS:PT17024 for PT standard base: Without logical isolation, screw terminals.

²⁾ LZS:PT1721 for PT base with logical isolation, screw terminals and plug-in terminals.

Coupling Relays with LZS, LZX Plug-in Relays

Plug-in relay couplers

Design

Plug-in relay coupling links can be ordered complete or as single modules.

Mounting

The relays are plugged into the base and this is snapped onto a TH 35 standard mounting rail according to EN 60715.

A retaining bracket can be ordered for the MT series that additionally fixes the relay into a plug-in base (under conditions of increased mechanical stress). For the RT and PT series, a combined fixing and ejection bracket is available which can be used to remove the relay where access is difficult, for example, when relays are mounted side-by-side.

They can be mounted as required.

Function

In accordance with the technical specifications of electronic systems, the coupling links have a lower power consumption. In the versions equipped with LEDs, these indicate the switching state. The LZS:PT/MT plug-in relay couplers have a test button. This can be used to force the plug-in relay coupler into the tripped state and to lock it. This is indicated by a raised petrol-colored lever.

Surge suppression

The 24 V DC relays LZX:RT and LZX: PT with LEDs can be supplied with, all others without integral surge suppression (free-wheel diode connected in parallel with A1/A2). The positive supply voltage must be connected to coil terminal A1.

Logical disconnection

The terminals for the contacts and the terminals for the coil are arranged on separate levels, e. g. above for contacts and below for coil. Logical isolation is not necessarily protective separation.

Protective separation

For protective separation, transfer of the voltage of one circuit to another circuit is prevented to a suitable degree of safety (requirements and tests are described in EN 60947-1 in Appendix N).

Control with solid-state output

In the case of solid-state outputs (e. g. BERO) with overload and short-circuit protection, you must make allowance during configuration for the temporarily flowing capacitor charging currents!

This is possible, for example, by using a suitable LZS plug-in relay coupler.

Technical specifications

Relay type		LZX:RT print relay, 8-pole, (12.7 mm) 1 CO/2 CO				LZX:PT industrial relay, 8-, 11- and 14-pole, (22.5 mm) 2 CO/3 CO/4 CO			
General data									
Rated control supply voltage U_s ¹⁾	V	24 DC	24 AC	115 AC	230 AC	24 DC	24 AC	115 AC	230 AC
Rated insulation voltage U_i Degree of pollution	V	250	3			250	3		
Overvoltage category Acc. to EN 60947-1, Appendix N		III				III			
Protective separation Between the coil and the contacts Acc. to EN 60947-1, Appendix N		Up to 250 V (with plug-in base LZS:RT78726) No (for complete units with standard socket)				No			
Degree of protection of relay/base		IP67/IP20				IP50/IP20			
Permissible ambient temperature									
• During operation	°C	-40 ... +70				-40 ... +70			
• During storage	°C	-40 ... +80				-40 ... +80			
Conductor cross-sections									
• Solid									
- LZS:RT.A.../LZS:RT.B....	mm ²	2 x 2.5				2 x 2.5			
- LZS:RT.D....	mm ²	2 x 0.75 ... 1.5				2 x 0.75 ... 1.5			
• Finely stranded with or without end sleeve									
- LZS:PT.A.../LZS:PT.B....	mm ²	2 x 1.5				2 x 1.5			
- LZS:PT.D....	mm ²	2 x 0.75 ... 1.5/1.0				2 x 0.75 ... 1.5/1.0			
• Permissible opening tool		Screwdriver for slotted screws, 3.0 ... 3.5 mm x 0.5 mm							
Control side									
Operating range									
At 20 °C	V	16.8 ... 52	18 ... 52	86.3 ... 127	172 ... 264	18 ... 40.8	19.2 ... 39.6	92 ... 190	184 ... 380
Power consumption at U_s		0.4 W	0.75 VA	0.75 VA	0.75 VA	0.75 W	1 VA	1 VA	1 VA
Release voltage	V	2.4	7.2	34.5	69	3.6	7.2	34.5	69
Permissible residual current	mA	1.5	4.2	0.8	0.4	2.8	8.8	1.9	1.0
Protection circuit		Freewheel diode for complete unit	No			Freewheel diode in LED module	No		
Max. permissible cable length at U_s ²⁾ (min. cross-section: 0.75 mm ²)	m	> 2000	30 (with LED), 20 (without LED)			> 2000	500	200	50
Load side									
Switching voltage AC/DC	V	24 ... 250				24 ... 250			
Rated currents³⁾									
• Continuous thermal current I_{th}	A	16/8 (1 CO/2 CO)				12/10/6 (2 CO/3 CO/4 CO)			
• Rated operational current I_e AC-15 acc. to utilization categories (EN 60947)	A	6/3				5/5/4			
• Rated operational current I_e DC-13 acc. to utilization categories (EN 60947)	A	2 at 24 V 0.27 at 230 V				5 at 24 V 0.5 at 230 V			
Short-circuit protection $I_k \geq 1$ kA acc. to IEC 60947-5-1 Fuse links gL/gG operational class DIAZED	A	10				6			
Shock resistance Half-sine acc. to IEC 60028-2-27	g/ms	10/11				9/11			
Vibration resistance									
Floating sine acc. to IEC 60068-2-6; 30 ... 150 Hz									
• Opening the normally-closed contacts along the critical axis	g	5				Approx. 7			
• Closing the normally-open contacts	g	> 20				> 20			
Min. contact load (reliability: 1 ppm)		Standard 17 V, 10 mA; hard gold-plated 17 V/0.1 mA				Standard 17 V, 10 mA; hard gold-plated 20 mV/1 mA			
Mechanical endurance	Operating cycles	30 x 10 ⁶	10 x 10 ⁶			10 x 10 ⁶			
Electrical endurance (resistive load at 250 V AC)	Operating cycles	1 x 10 ⁵				1 x 10 ⁵			
Switching frequency (operating cycles)									
• Without load	1/min 1/h	1200 72000				600 36000			
• With load	1/min 1/h	6 360				6 360			
Make-time	ms	7				15			
Break-time	ms	3				10			
Bounce time	ms	2				5			
Contact material		AgNi 90/10							

¹⁾ AC voltages, 50 Hz; for 60 Hz operation, the lower response value must be increased by 10 %; the power loss will reduce slightly.

²⁾ The max. cable length depends on the conductor capacity and the cable installation. It can be increased by means of parallel load on A1/A2.

³⁾ Capacitive loads can result in micro-weldings on the contacts.

Coupling Relays with LZS, LZX Plug-in Relays

Plug-in relay couplers

Relay type	MT industrial relay, 11-pole (35.5 mm) 3 CO				
AC and DC operation					
Rated control supply voltage $U_s^{1)}$	V	24 DC	24 AC	115 AC	230 AC
Rated insulation voltage U_i Degree of pollution	V	250 3			
Overvoltage category Acc. to EN 60664-1		III			
Protective separation Between the coil and the contacts Acc. to EN 60947-1, Appendix N		No			
Degree of protection of relay/base		IP50/IP20			
Permissible ambient temperature					
• During operation	°C	-40 ... +60	-45 ... +50	-45 ... +50	-45 ... +50
• During storage	°C	-45 ... +80	-45 ... +80	-45 ... +80	-45 ... +80
Conductor cross-sections					
• Screw terminals					
- Solid	mm ²	2 x 2.5			
- Finely stranded with or without end sleeve	mm ²	2 x 1.5			
- Permissible opening tool		Screwdriver size 1 or Pozidriv 1			
Control side					
Operating range					
• At 20 °C	V	18 ... 38	19.2 ... 38	92 ... 137	184 ... 264
Power consumption at U_s		1.2 W	2.3 VA	2.3 VA	2.3 VA
Release voltage	V	2.4	9.6	46	92
Permissible residual current	mA	4.5	29.2	6.2	3.0
Protection circuit		No			
Max. permissible cable length at $U_s^{2)}$ (min. cross-section: 0.75 mm ²)	m	> 2000	On request	On request	80
Load side					
Switching voltage					
• AC/DC	V	24 ... 250			
Rated currents³⁾					
• Continuous thermal current I_{th}	A	10			
• Rated operational current I_o /DC-13 acc. to utilization categories (EN 60947)	A	2 at 24 V 0.27 at 230 V			
• Rated operational current I_o /AC-15 acc. to utilization categories (EN 60947)	A	5 at 24 V and 230 V			
Short-circuit protection $I_k \geq 1$ kA acc. to IEC 60947-5-1 Fuse links gL/gG operational class DIAZED	A	10			
Shock resistance Half-sine acc. to IEC 60028-2-27	g/ms	13/11			
Vibration resistance					
Floating sine acc. to IEC 60068-2-6 30 ... 150 Hz					
• Opening the normally-closed contacts along the critical axis	g	2			
• Closing the normally-open contacts	g	> 20			
Min. contact load (reliability: 1 ppm)		12 V DC/10 mA			
Mechanical endurance	Oper- ating cycles	20 x 10 ⁶			
Electrical endurance (resistive load at 250 V AC)	Oper- ating cycles	4 x 10 ⁵			
Switching frequency (operating cycles)					
• Without load	1/min 1/h	100 6000			
• With load	1/min 1/h	20 1200			
Make-time	typ./ms	12			
Break-time	typ./ms	5			
Bounce time	typ./ms	4			
Contact material		AgNi 90/10			

1) AC voltages, 50 Hz; for 60 Hz operation, the lower response value must be increased by 10 %; the power loss will reduce slightly.

2) The max. cable length depends on the conductor capacity and the cable installation. It can be increased by means of parallel load on A1/A2.

3) Capacitive loads can result in micro-weldings on the contacts.

Plug-in relay couplers

More information

Notes on configuration

PT series

Mounting the LZS:PT17024 fixing/ejection bracket on the LZS:PT787.0 standard plug-in base with screw terminals

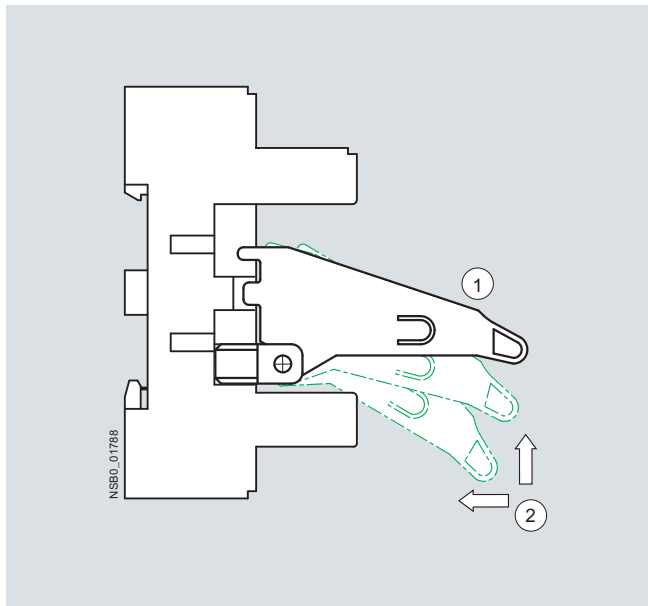

Legend:

- ① Locking position
- ② Mounting direction

Mounting the coupling relays with plug-in relay

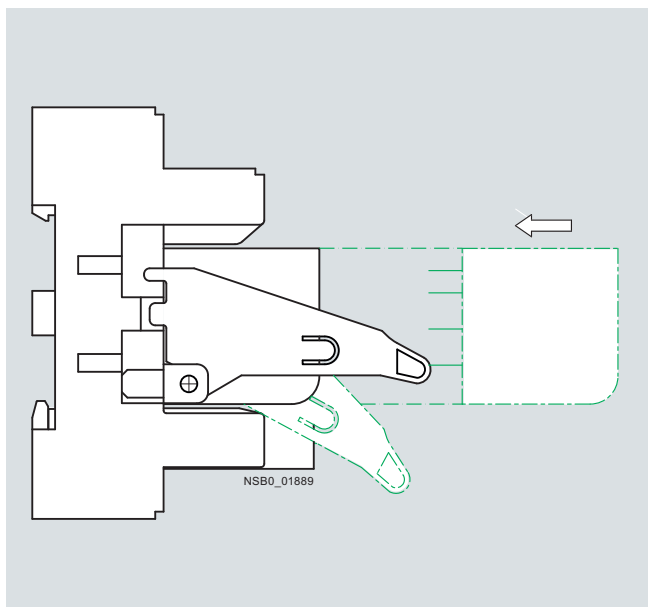

Important:
The LZS:PT17021 and LZS:PT17024 ejection brackets of the coupling relays with plug-in relay are not status displays!

RT series

Mounting the LZS:RT17016 fixing/ejection bracket on the LZS:RT7872. plug-in base

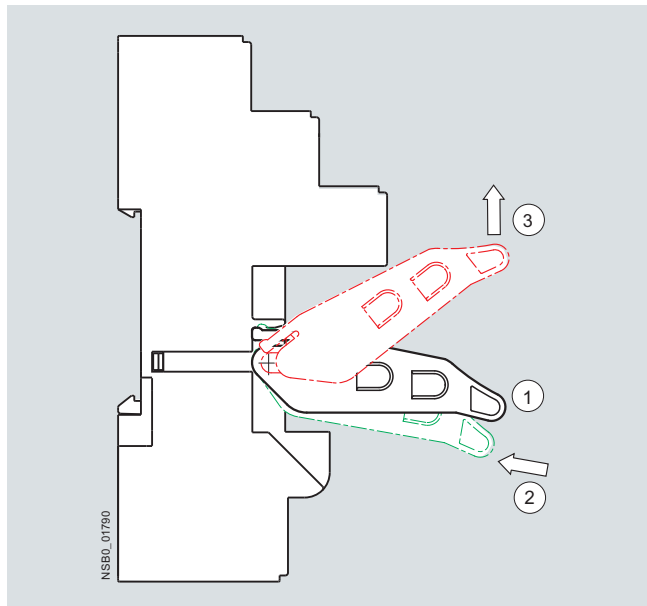

Legend:

- ① Locking position
- ② Mounting direction
- ③ Demounting direction

Mounting the coupling relays with plug-in relay

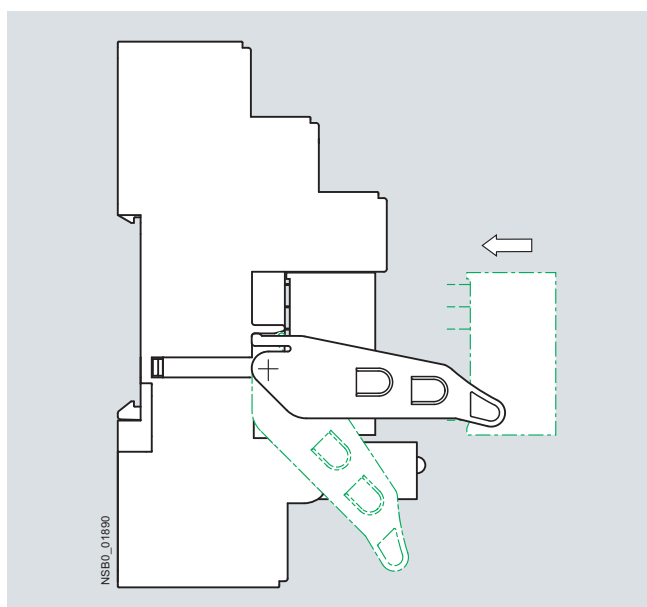

Important:
The LZS:RT17016 ejection brackets of the coupling relays with plug-in relay are not status displays!

3TG10 Power Relays/Miniature Contactors

4-pole, 4 kW

Overview

Version

The 3TG10 power relays/miniature contactors with 4 main contacts are available with 6.3 mm × 0.8 mm screw terminals or flat connectors. The versions with screw terminals are climate-proof and finger-safe according to EN 61140.

The 3TG10 power relays/miniature contactors are small. The overall width is 36 mm.



Technical specifications

Type	3TG10		
General data			
Endurance			
• Mechanical	Operating cycles		3 million
• Electrical			
- AC-1 at I_e	Operating cycles		0.1 million
- AC-3 at I_e	Operating cycles		0.4 million
Rated insulation voltage U_i (degree of pollution 3)	V		400
Rated impulse withstand voltage U_{imp}	kV		4
Protective separation			
Between the coil and the contacts acc. to EN 60947-1, Appendix N	V		Up to 300
Permissible ambient temperature			
• During operation ¹⁾	°C		-25 ... + 55
• During storage	°C		-50 ... + 80
Degree of protection acc. to IEC 60947-1 and EN 60529 (VDE 0470 Part 1)			IP00, drive system IP20
Power consumption of the magnetic coils (when coil is cold and $1.0 \times U_s$)			
• AC operation 45 ... 450 Hz	VA		4.4
• P.f.			0.9 (hum-free)
• DC operation	W		4
Magnetic coil operating range			$0.85 \dots 1.1 \times U_s$
Operating times (Total break time = OFF-delay + Arcing time)			
• ON-delay			
- Closing NO	DC operation	ms	11 ... 50
	AC operation	ms	10 ... 50
- Opening NC	DC operation	ms	21 ... 39
	AC operation	ms	20 ... 30
• OFF-delay			
- Closing NC	DC operation	ms	5 ... 45
	AC operation	ms	5 ... 45
- Opening NO	DC operation	ms	19 ... 35
	AC operation	ms	20 ... 30
• Arcing time			
		ms	10 ... 15
Shock resistance			
• Rectangular pulse	AC operation and DC operation	g/ms	5.1/5 and 3.5/10
• Sine pulse	AC operation and DC operation	g/ms	7.9/5 and 5.2/10
Switching frequency z in operating cycles/hour rated operation			
	Acc. to AC-1	1/h	1000
	Acc. to AC-2	1/h	500
	Acc. to AC-3	1/h	1000
	No-load switching frequency	1/h	10000
Short-circuit protection			
Fuse links			
gL/gG operational class LV HRC 3NA, DIAZED 5SB, NEOZED 5SE acc. to IEC 60947-4-1 (VDE 0660 Part 102)			
	• Type of coordination "1"	A	25
	• Type of coordination "2"	A	10
Miniature circuit breakers	C Characteristic	A	10
AC capacity			
Utilization category AC-1, switching resistive loads			
Rated operational current I_e up to 400 V at 55 °C ¹⁾	A		20 for screw terminals, 16 for flat connector
Rated power U_e for AC loads with p.f. = 1, 230/220 V			
• For screw terminals	kW		7.5 (13 at 400 V)
• For flat connector	kW		6 (10 at 400 V)
Minimum conductor cross-section for load with I_e	mm ²		2.5
Utilization category AC-2 and AC-3			
Operational current for AC-3 at 400 V rated value	A		8.4
Rated power for slipring or squirrel-cage motors with 50 Hz and 60 Hz and at 400 V	W		4000
Utilization category AC-5a (permissible nominal impedance: $\geq 0.5 \Omega$)			
Switching gas discharge lamps			
Per main current path at 230 V, 50 Hz			
Rated power/rated operational current per lamp			
• Uncorrected	18 W	0.37 A	43
	36 W	0.43 A	37
	58 W	0.67 A	24
• DUO switching	18 W	2 x 0.11 A	2 x 81
	36 W	2 x 0.21 A	2 x 42
	58 W	2 x 0.32 A	2 x 28

¹⁾ If the three main current paths carry a load of 20 A, the following applies if $I > 10$ A for the fourth conducting path: permissible ambient temperature 40 °C.

3TG10 Power Relays/Miniature Contactors

4-pole, 4 kW

Type	3TG10					
AC capacity						
Switching gas discharge lamps with correction, solid-state ballast						
Per main current path 230 V, 50 Hz						
Rated power per lamp/capacitance/rated operational current per lamp						
• Shunt compensation	L18 W	4.5 µF	0.11 A	Units	15	
	L36 W	4.5 µF	0.21 A	Units	15	
	L58 W	7 µF	0.32 A	Units	10	
• With solid-state ballast (single lamp)	L18 W	6.8 µF	0.10 A	Units	39	
	L36 W	6.8 µF	0.18 A	Units	39	
	L58 W	10 µF	0.27 A	Units	26	
• With solid-state ballast (two lamps)	L18 W	10 µF	0.18 A	Units	2 x 26	
	L36 W	10 µF	0.35 A	Units	2 x 26	
	L58 W	22 µF	0.52 A	Units	2 x 12	
Utilization category AC-5b, switching incandescent lamps				kW	1.6	
Per main current path at 230 V, 50 Hz						
Load rating with DC						
Utilization category DC-1, switching resistive load ($L/R \leq 15$ ms)						
• Rated operational currents I_e						
- 1 conducting path			Up to 24 V	A	16	
			60 V	A	6	
			110 V	A	2	
			220/240 V	A	0.8	
- 2 conducting paths in series			Up to 24 V	A	16	
			60 V	A	16	
			110 V	A	6	
			220/240 V	A	1.6	
- 3 conducting paths in series			Up to 24 V	A	18	
			60 V	A	18	
			110 V	A	16	
			220 / 240 V	A	6	
- 4 conducting paths in series			Up to 24 V	A	20	
			60 V	A	20	
			110 V	A	20	
			220 / 240 V	A	20	
Utilization category DC-3 and DC-5						
Shunt-wound and series-wound motors ($L/R \leq 15$ ms)						
• Rated operational currents I_e						
- 1 conducting path			Up to 24 V	A	10	
			60 V	A	0.5	
			110 V	A	0.15	
			220/240 V	A	0	
- 2 conducting paths in series			Up to 24 V	A	16	
			60 V	A	5	
			110 V	A	0.35	
			220/240 V	A	0	
- 3 conducting paths in series			Up to 24 V	A	16	
			60 V	A	16	
			110 V	A	10	
			220/240 V	A	1.75	
- 4 conducting paths in series			Up to 24 V	A	18	
			60 V	A	16	
			110 V	A	10	
			220/240 V	A	2	
Conductor cross-sections						
					Screw terminals	
• Finely stranded with end sleeve (DIN 46228 Form A/D/C)				mm ²	M3	
• Solid				mm ²	2 x (0.75 ... 2.5) 2 x (1 ... 2.5), 1 x 4	
					Flat connectors	
• Finely stranded 6.3 mm plug-in sleeve acc. to DIN 46245/46247				mm ²	0.5 ... 1	
- 6.3 ... 1				mm ²	1 ... 2.5	
- 6.3 ... 2.5				mm ²		
Ⓢ and Ⓣ ratings (screw terminals)						
Rated insulation voltage				AC V	600	
Uninterrupted current				• Open and enclosed A	20	
Maximum horsepower ratings					1-phase/3-phase	
(Ⓢ and Ⓣ approved values), rated power for induction motors with 60 Hz						
				At 115 V	hp	0.5/ --
				200 V	hp	1/ 3
				230 V	hp	1.5/ 3
				460 V	hp	0/ 5
				575 V	hp	0/ 5
				600 V	hp	0/ 5

For short-circuit protection for overload see "Protection Equipment --> Overload Relays".

Accessories and Spare Parts

For 3RT, 3RH Contactors and Contactor Relays

Accessories for 3RT, 3RH contactors and contactor relays

Overview

Snap-on auxiliary switch blocks

The auxiliary switch blocks and the maximum number of blocks that can be mounted are described in the sections "Motor Contactors" and "Contactor Relays".

Solid-state time-delay auxiliary switch block

The timer module, which is available in the "ON-DELAY" and "OFF-DELAY" versions, allows time-delayed functions up to 100 s (3 distinct delay ranges).

It contains a relay with one NO contact and one NC contact; depending on the version, the relay is switched either after an ON-delay or after an OFF-delay.

The timer module with "WYE-DELTA FUNCTION" is equipped with one delayed and one instantaneous NO contact, with a dead time of 50 ms between the two. The delay time of the NO contact can be adjusted between 1.5 s and 30 s.

Wye-delta function:

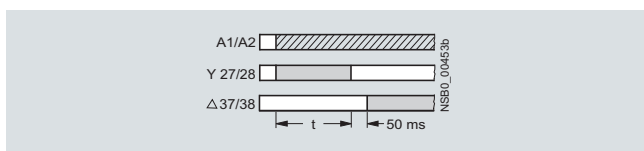

The contactor on which the solid-state, time-delay auxiliary switch block is mounted operates without a delay.

Size S00

The solid-state, time-delay auxiliary switch block is fitted onto the front side of the contactor. The timer module is supplied with power directly by plug-in contacts through the coil terminals of the contactor, in parallel with A1/A2. The timing function is activated by closing the contactor on which the auxiliary switch block is mounted. The OFF-delay version operates without an auxiliary voltage; minimum ON period: 200 ms.

A varistor is integrated in the timer module in order to damp opening surges in the contactor coil.

The solid-state, time-delay auxiliary switch block cannot be mounted on size S00 coupling relays.

Sizes S0 to S12

The solid-state, time-delay auxiliary switch block is fitted onto the front side of the contactor.

The timer module is supplied with power through two terminals (A1/A2); the time delay of the auxiliary switch block can be activated either by a parallel link to any contactor coil or by any power source.

The OFF-delay version operates without an auxiliary voltage; minimum ON period: 200 ms.

A single-pole auxiliary switch block can be snapped onto the front of the contactor in addition to the timer module.

The timer module has no integrated components for overvoltage damping.

Solid-state timing relay block with semiconductor output

The timer module in the "ON-DELAY" and "OFF-DELAY with auxiliary voltage" versions allows time-delayed functions up to 100 s (3 distinct delay ranges). Contactors fitted with a timing relay block close or open after a delay according to the set time.

The ON-delay variant of the timing relay is connected in series with the contactor coil; terminal A1 of this coil must not be connected.

With the OFF-delay variant of the timing relay, the contactor coil is contacted directly through the relay; terminals A1 and A2 of the contactor coil must not be connected.

The timing relays are suitable for both AC and DC operation.

Size S00

The version for size S00 contactors is fitted onto the front of the contactor (with the supply voltage switched off) and then slid into its latched position; at the same time, the timing relay is connected by means of plug-in contacts to coil terminals A1 and A2 of the contactor. Any contactor coil terminals which are not required are sealed off by means of covers on the enclosure of the timing relay block, to prevent them from being connected inadvertently.

A varistor is integrated in the timer module in order to damp opening surges in the contactor coil.

The solid-state, timing relay block cannot be mounted on size S00 coupling relays.

Sizes S0 to S3

The timing relay block for size S0 to S3 contactors is plugged into coil terminals A1 and A2 on top of each contactor; the timing relay is connected both electrically and mechanically by means of pins.

A varistor is integrated in the timer module in order to damp opening surges in the contactor coil.

Configuring note:

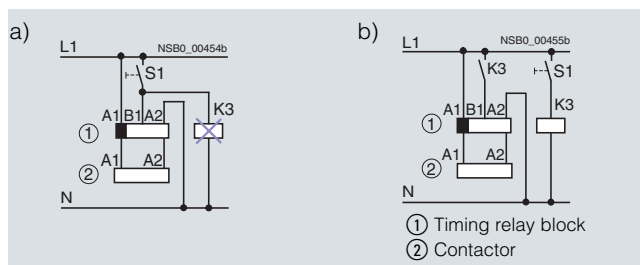

The activation of loads parallel to the start input is not permissible when using AC control voltage (see (a) in the circuit diagram).

The 3RT19 16-2D.../3RT19 26-2D... OFF-delay time relay blocks have a zero potential start input B1. This means that if there is a parallel load on terminal B1, activation can be simulated with AC voltage. In this case, the additional load (e. g. contactor K3) must be wired according to (b).

OFF-delay device for size S00 to S3 contactors

AC and DC operation

IEC 60947, EN 60947.

For screw and snap-on mounting onto 35 mm standard mounting rail. The OFF-delay devices have screw terminals.

The OFF-delay device prevents a contactor from dropping out unintentionally when there is a short-time voltage dip or voltage failure. It supplies a downstream, DC-operated contactor with the necessary energy during a voltage dip, ensuring that the contactor does not trip. The 3RT19 16 OFF-delay devices are specifically designed for operation with the 3RT contactors and 3RH contactor relays of the SIRIUS series.

The OFF-delay device operates without external voltage on a capacitive basis, and can be energized with either AC or DC (24 V version only for DC operation). Voltage matching, which is only necessary with AC operation, is performed using a rectifier bridge.

A contactor opens after a delay when the capacitors of the magnetic coil, built into the OFF-delay device, are switched in parallel. In the event of voltage failures, the capacitors are discharged via the magnetic coil and thereby delay the opening of the contactor.

Accessories and Spare Parts

For 3RT, 3RH Contactors and Contactor Relays

Accessories for 3RT, 3RH contactors and contactor relays

If the command devices are upstream of the OFF-delay device in the circuit, the OFF-delay takes effect with every opening operation. If the opening operation is downstream of the OFF-delay device, an OFF-delay only applies in the event of failure of the mains voltage.

Operation

In the case of the versions for rated control supply voltages of 110 V and 230 V, either AC voltage or DC voltage can be applied on the line side, whereas the variant for 24 V is designed for DC operation only.

A DC-operated contactor is connected to the output in accordance with the input voltage that is applied.

The mean value of the OFF-delay is approximately 1.5 times the specified minimum time.

Surge suppressors

- Without LED (also for Cage Clamp terminals) size S00, S0, S2, S3, S6 to S12
- With LED (also for Cage Clamp terminals) size S00

All 3RT1 contactors and 3RH1 contactor relays can be retrofitted with RC elements or varistors for damping opening surges in the coil. Diodes or diode assemblies (comprising noise suppression diodes and Zener diodes for rapid switch-off) can be used.

The surge suppressors are plugged onto the front of size S00 contactors. Space is provided for them next to a snap-on auxiliary switch block.

With all size S0 to S3 contactors, varistors, RC elements and diode assemblies can be plugged on directly at the coil terminals, either on the top or underneath.

The plug-in direction of the diodes and diode assemblies is determined by a coding device.

Coupling relays are supplied either without overvoltage damping or with a varistor or diode connected as standard, according to the version.

Note:

The OFF-delay times of the NO contacts and the ON-delay times of the NC contacts increase if the contactor coils are damped against voltage peaks (noise suppression diode 6 to 10 times; diode assemblies 2 to 6 times, varistor +2 to 5 ms).

Electromagnetic interference suppression module, 3-phase for size S00 contactors



A so-called counter-e.m.f. (electromotive force) is produced when motors or various inductive loads are turned off. Voltage peaks of up to 4000 V may occur as a result, with a frequency spectrum from 1 kHz to 10 MHz and a rate of voltage variation from 0.1 to 20 V/ns.

Capacitive input to various analog and digital signals makes it necessary to suppress interference in the load circuit.

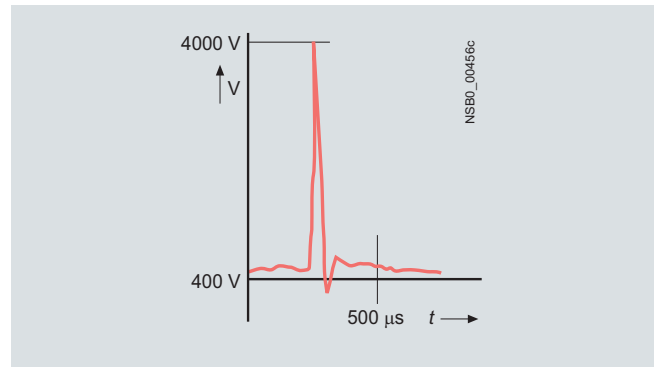

Reducing contact arcing

The connection between the main current path and the EMC interference suppression module enables contact arcing, which is responsible for contact erosion and the majority of clicking noises, to be reduced; this in turn is conducive to an electromagnetically compatible design.

Higher operational reliability

Since the EMC interference suppression module achieves a significant reduction in radio-frequency components and the voltage level in three phases, the contact endurance is also improved considerably. This makes an important contribution towards enhancing the reliability and availability of the system as a whole.

Dispensing with fine graduations

There is no need for fine graduations within each performance class, as smaller motors inherently have a higher inductance, so that one solution for all fixed-speed operating mechanisms up to 5.5 kW is adequate.

Two electrical versions are available:

- The advantages of the RC circuit lie mainly in the reduction in the rate of rise and in its RF damping ability. The selected values ensure effective interference suppression over a wide range.

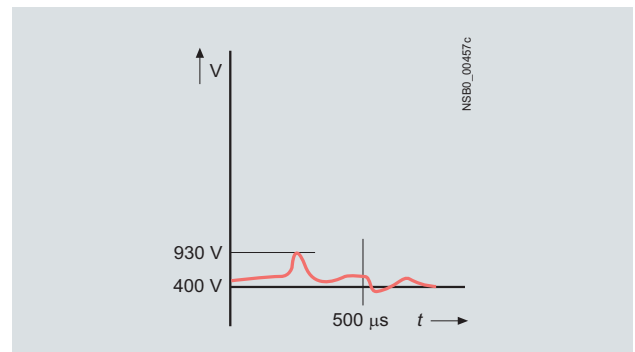

- The varistor circuit can absorb a high energy level and can also be used for frequencies ranging from 10 to 400 Hz (closed-loop controlled operating mechanisms). There is no limiting below the knee-point voltage, however.

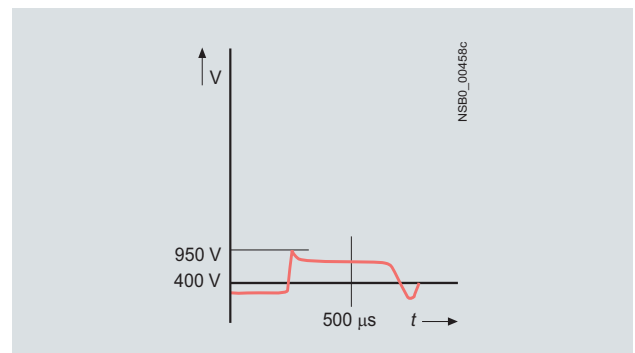

Accessories and Spare Parts

For 3RT, 3RH Contactors and Contactor Relays

Accessories for 3RT, 3RH contactors and contactor relays

Additional load module

Size S00 for plugging onto the front of the contactors with and without auxiliary switch block

Coupling links for mounting on contactors of sizes S0 to S3

DC operation

IEC 60947 and EN 60947.

The coupling link is suitable for use in any climate. It is finger-safe according to EN 50274. The terminal designations comply with EN 50005.

System-compatible operation with 24 DC V, operating range 17 to 30 V.

Low power consumption in conformity with the technical specifications of the solid-state systems. An LED indicates the switching state.

Surge suppression

The 3RH19 24-1GP11 coupling link has an integrated surge suppressor (varistor) for the contactor coil being switched.

Mounting

The 3RH19 24-1GP11 coupling link is mounted directly on the contactor coil.

Solder pin adapters

The solder pin adapters for the size S00 contactors are available in two versions:

- Solder pin adapter for contactors with one integrated auxiliary contact
- Solder pin adapter for contactors with mounted 4-pole auxiliary switch block

Screw adapters

Plug-on adapters improve the accessibility of the screw fixing for size S0 contactors. As a result it is possible to position the screwdriver vertically even when using insulated screwdrivers or power screwdrivers.

Optionally the adapters can be rotated through 90° before mounting.

Sealable covers for sizes S00 to S12

When contactors and contactor relays are used in safety-oriented applications, it must be ensured that it is impossible to operate the contactors manually.

For SIRIUS contactors there are sealable covers available for this purpose as accessories; these prevent accidental manual operation. These are transparent molded-plastic caps with a bracket that enables the contactor to be sealed.

Technical specifications

Technical specifications according to EN 61812-1 (VDE 0435 Part 2021)

Contactors	Type	3RT19 26-3A Mechanical latching block for the 3RT1. 2. and 3RT1. 3. contactors	
Rated insulation voltage U_i (degree of pollution 3)	V	690	
Mechanical endurance (operating cycles)	<ul style="list-style-type: none"> • With 3RT1. 2 • With 3RT1. 3 	3 million 50 000	
Permissible ambient temperature			
• During operation	°C	-25 ... +60	
• During storage	°C	-50 ... +80	
Degree of protection acc. to EN 60947-1, Appendix C		IP20	
Operating range of the magnetic coil At AC 50/60 Hz and DC		0.85 ... 1.1 x U_s	
Power consumption of the magnetic coils of the unlocking magnet (for cold coil and 1.0 x U_s) AC and DC operation	W	Approx. 4	
Command duration for de-energizing			
• AC operation	ms	18 ... 31	
• DC operation	ms	18 ... 26	
Conductor cross-sections			
• Solid	mm ² AWG	2 x (0.5 ... 2.5); 1 x 4 2 x 14; 1 x 12	
• Finely stranded with end sleeve	mm ² AWG	2 x (0.5 ... 2.5); 1 x 2.5 2 x 14; 1 x 12	
Tightening torque of the terminal screws	Nm lb.in	0.8 ... 1.1 7 ... 9.5	

Accessories and Spare Parts



For 3RT, 3RH Contactors and Contactor Relays

Accessories for 3RT, 3RH contactors and contactor relays

Contactor	Type		3RT19 .6-2C Solid-state time-delay blocks with semi-conductor output	3RT19 .6-2D 3RT19 .6-2L 3RT19 .6-2E 3RT19 .6-2F 3RT19 .6-2G Solid-state time-delay auxiliary switch blocks
Rated insulation voltage U_i Degree of pollution 3 Overvoltage category III acc. to EN 60664-1		V AC	250	300 250
Operating range of excitation			0.8 ... 1.1 x U_{S1} 0.95 ... 1.05 times rated frequency	0.85 ... 1.1 x U_{S1} 0.95 ... 1.05 times rated frequency
Rated power • Power consumption at 230 V AC, 50 Hz		W VA	1 1	2 4
Rated operational currents I_e • AC-140, DC-13 • AC-15, 230 V, 50 Hz • DC-13, 24 V • DC-13, 110 V • DC-13, 230 V		A A A A A A	0.3 for 3RT19 16 0.3 for 3RT19 26 -- -- -- --	-- -- 3 1 0.2 0.1
DIAZED protection gL/gG operational class		A	--	4
Switching frequency for load • With I_e 230 V AC • With 3RT10 16 contactor, 230 V AC		h^{-1} h^{-1}	2500 2500	5000
Recovery time		ms	50	150
Minimum ON period		ms	35	35 (OFF-delay with auxiliary voltage) 200 (with OFF-delay)
Residual current	Max.	mA	5	--
Voltage drop With conducting output	Max.	VA	3.5	--
Short-time loading capacity	Up to 10 ms	A	10	--
Setting accuracy With reference to upper limit of scale	Typ.	%	±15	
Repeat accuracy	Max.	%	±1	
Mechanical endurance		Oper-ating cycles	100 x 10 ⁶	10 x 10 ⁶
Permissible ambient temperature • During operation • During storage		°C °C	-25 ... +60 -40 ... +80	
Degree of protection acc. to EN 60947-1, Appendix C • Cover • Terminals			IP40 IP20	
Conductor connections • Solid • Finely stranded with end sleeve • AWG cables, solid or stranded • Terminal screws • Tightening torque		mm ² mm ² AWG M3 Nm	2 x (0.5 ... 1.5), 2 x (0.75 ... 4) 2 x (0.5 ... 2.5) 2 x (18 ... 14) M3 0.8 ... 1.2	
Permissible mounting position			Any	
Shock resistance Half-sine acc. to IEC 60068-2-27		g/ms	15/11	
Vibration resistance Acc. to IEC 60068-2-6		Hz/mm	10 ... 55/0.35	
EMC tests	Basic specification		IEC 61000-6-4	IEC 61000-6-2; IEC 61000-6-4 IEC 61000-6-4
Overvoltage protection			Varistor integrated in timing relay	--

Accessories and Spare Parts For 3RT, 3RH Contactors and Contactor Relays

Accessories for 3RT, 3RH contactors and contactor relays

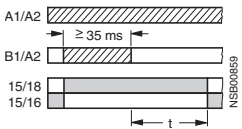
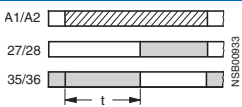
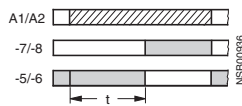
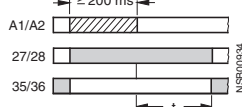
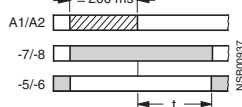
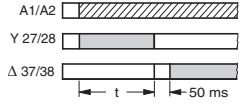
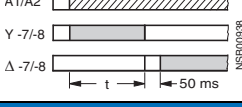
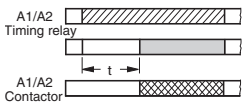
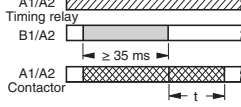
Function table 3RT19 16, 3RT19 26	Function chart	3RT19 16 timing relays						3RT19 26 timing relays				
Function	 Timing relay energized  Contact closed  Contact open	3RT19 16-2C	3RT19 16-2D	3RP19 16-2E	3RT19 16-2F	3RT19 16-2G	3RT19 16-2L	3RT19 26-2C	3RT19 26-2D	3RT19 26-2E	3RT19 16-2F	3RT19 26-2G
1 CO contact												
OFF-delay With auxiliary voltage							✓					
1 NO contact + 1 NC contact												
ON-delay (varistor integrated)			✓									
With ON-delay									✓			
OFF-delay Without auxiliary voltage (varistor integrated)					✓							
OFF-delay without auxiliary voltage										✓		
2 NO contacts												
Wye-delta function (varistor integrated) 1 NO delayed, 1 NO instantaneous, dead time 50 ms						✓						
Wye-delta function 1 NO delayed, 1 NO instantaneous, dead time 50 ms										✓		
1 NO contact (semiconductor)												
ON-delay Two-wire version (varistor integrated)		✓						✓				
OFF-delay With auxiliary voltage (varistor integrated)			✓						✓			

✓ Function is possible.

Accessories and Spare Parts

For 3RT, 3RH Contactors and Contactor Relays

Accessories for 3RT, 3RH contactors and contactor relays

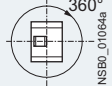
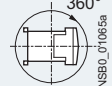
Versions		3RT19 16-2BE01 OFF-delay devices	3RT19 16-2BK01	3RT19 16-2BL01
Connectable contactor sizes Caution! Only contactors and contactor relays with DC operation can be connected.		S00 ...S3	S00/S0 S00/S0	S00/S0 S00/S0
• DC supply		--		
• AC supply	Type	3RT10 ...-1BB4., 3RH1. ...-1BB40	3RT10 1.-1BF4, 3RT10 2.-1BF4, 3RH1. ...-1BF40	3RT10 1.-1BM4./1BP4., 3RT10 2.-1BM4./1BP4., 3RH1. ...-1BM40/1BP40
Permissible mounting position				
Rated control supply voltage U_s Operating range	V	24 (DC) 0.9 ... 1.1 U_s	110 (UC)	220/230 (UC)
Rated frequency/ies with AC supply	f	Hz $\pm 5\%$	50/ 60	50/ 60
Ambient temperature permissible:				
• During operation				
- Side-by-side mounting without distance	T_u	°C	-25 ... +50	
- Side-by-side mounting with 5 mm distance	T_u	°C	-25 ... +60	
• During storage	T_u	°C	-40 ... +80	
OFF-delay¹⁾ (minimum times at $U_{sp} = 0.9 \times U_s$, $T_{sp} = 20\text{ °C}$)			Note: In practice the mean value is 1.5 times the minimum time.	
• S00	$t_{off} >$	ms	250	600
• S0	$t_{off} >$	ms	150	400
• S2 (only for DC supply)	$t_{off} >$	ms	90	--
• S3 (only for DC supply)	$t_{off} >$	ms	70	--
Installed capacity C 3RT19 16-2B.01	μF	2000	68	68
Capacitor voltage	V	35	180	350
ON-delay (maximum at $U_{sp} = 0.9 \times U_s$, $T_{sp} = 20\text{ °C}$)			Note: The total ON-delay = Contactor make-time + t_{on}	
• S00	$t_{on} <$	ms	10	200
• S0	$t_{on} <$	ms	10	250
Mechanical endurance	Operating cycles		30 million	
Endurance, electrical approx.	Operating cycles		> 1 million	
Switching frequency z max. (at $T_u = 60\text{ °C}$)	h^{-1}		300	
Power loss P_v max. approx.	W		0.4	1
Surge suppression			with varistor, integrated	
Conductor cross-sections U_{sp} = Coil voltage T_{sp} = Coil temperature			2)	

1) Doubling the delay time can be achieved by doubling the capacitance. Commercially available capacitors can be used, which can be connected to terminals C+ and Z-.

2) See 3RT10 1 contactors, page 3/23.

Accessories and Spare Parts

For 3RT, 3RH Contactors and Contactor Relays

Accessories for 3RT, 3RH contactors
and contactor relays

Contactors	Type	3RT19 26-2P. Pneumatic delay block ¹⁾	
General data			
Mechanical endurance	Operating cycles	5 million	
Electrical endurance at I_e	Operating cycles	1 million	
Rated insulation voltage U_i (degree of pollution 3)	V	690	
Permissible ambient temperature			
• During operation	°C	-25 ... +60	
• During storage	°C	-50 ... +80	
Rated operational currents I_e Acc. to utilization categories EN 60947			
• AC-12	A	10	
• AC-15/AC-14 at U_e	Up to 230/220 V A	6	
	400/380 V A	4	
	500 V A	2.5	
	690/660 V A	1.5	
• DC-13 at U_e	24 V A	4	
	48 V A	2	
	110 V A	0.7	
	220 V A	0.3	
	440 V A	0.15	
Conductor cross-sections			
• Solid, stranded:	mm ²	2 x 0.5 ... 2.5 ²⁾ or 2 x 2.5 ... 4 ²⁾	
• Finely stranded with end sleeve	mm ²	2 x 0.5 ... 2.5	
• AWG cables	AWG	2 x 22 ... 12	
• Tightening torque of the terminal screws	Nm	0.8 ... 1.1	
Time delay			
• Accuracy		±10 %	
Ⓢ and Ⓢ rated data			
• Rated voltage	V AC	600	
• Switching capacity		A 600, Q 600	

¹⁾ For size S0.
In addition to the pneumatic delay block, no other auxiliary contacts are permitted.

²⁾ If two different conductor cross-sections are connected to one clamping point, both cross-sections must lie in the range specified. If identical cross-sections are used, this restriction does not apply.

Versions	3RT1900-4RE01 plugs S00, S0		3RT1916-4RD01 adapters S00	3RT1926-4RD01 adapters S0
Connection modules for contactors with screw terminals				
General data				
Mechanical endurance	Operating cycles	10 million		
Electrical endurance at I_e	Operating cycles	1 million		
Rated operational voltage U_e	V	440		
Rated insulation voltage U_i (degree of pollution 3)	V	690		
Rated impulse withstand voltage U_{imp} (degree of pollution 3)	kV	6		
Protective separation acc. to EN 60947-1 (degree of pollution 3)	V	400		
Rated operational current I_e AC-3 at 400 V	A	25	20	25
Rated frequency f For AC operation	Hz	50/60		
Permissible ambient temperature				
• During operation	°C	-25 ... +60		
• During storage	°C	-50 ... +80		
Degree of protection acc. to EN 60529		IP20		
Conductor cross-sections Screw terminals				
• Solid	mm ²	1x (0.5 ... 6)		
• Finely stranded without/with end sleeve	mm ²	1x (0.5 ... 6)		
• Stranded	mm ²	1x (0.5 ... 6)		
• AWG cables, solid or stranded	AWG	1x (20 ... 10)		
• Tightening torque	Nm	0.6 ... 0.8		
• Corresponding opening tool		Short-slot screwdriver PZ2		

Accessories and Spare Parts

For 3RT, 3RH Contactors and Contactor Relays

Accessories for 3RT, 3RH contactors and contactor relays

Versions		3RT1900-4RE01 plugs S00, S0	3RT1916-4RD01 adapters S00	3RT1926-4RD01 adapters S0
Connection modules for contactors with screw terminals				
Ⓢ and Ⓛ rated data				
• Rated operational voltage U_e	V	480		
• Rated insulation voltage U_i	V	600		
• Uninterrupted current, at 40 °C	A	16/25	16	25
• Short-circuit protection ¹⁾				
	• At 600 V	kA	5	
	• CLASS RK5 fuse	A	100	60
	• Circuit breakers with overload protection acc. to UL 489	A	100	60
				100
				100
Combination motor controllers type E Acc. to UL 508				
	• At 480 V	Type	3RV102	
		A	22	--
		kA	65	--
	• At 600 V	Type	3RV102	
		A	22	--
		kA	10	--

¹⁾ For more information about short-circuit values, e. g. for protection against short-circuit currents, see the UL guide (Order No.: A5E02118883) or UL reports (<http://www.siemens.com/lowvoltage/support>) for the individual devices.

Contactor	Type	3RH19 24, 3TX7 090 Coupling links for mounting on contactors acc. to IEC 60947/EN 60947	
General data			
Rated insulation voltage U_i (degree of pollution 3)	V	300	
Protective separation between the coil and the contacts acc. to EN 60947-1, Appendix N	V AC	Up to 300	
Degree of protection acc. to EN 60947-1, Appendix C			
• Terminals		IP20	
• Enclosure		IP40	
Permissible ambient temperature			
• During operation	°C	-25 ... +60	
• During storage	°C	-40 ... +80	
Conductor cross-section			
• Solid	mm ²	2 x (0.5 ... 2.5)	
• Finely stranded with end sleeve	mm ²	2 x (0.5 ... 1.5)	
Terminal screws		M3	
Short-circuit protection (weld-free protection at $I_k \geq 1$ kA) Fuse links, gL/gG operational class LV HRC 3NA, DIAZED 5SB, NEOZED 5SE	A	6	
Control side			
Rated control supply voltage U_s	V DC	24	
Operating range	V DC	17 ... 30	
Power consumption at U_s	W	0.5	
Nominal current input	mA	20	
Release voltage	V	≥ 4	
Function display		LED yellow	
Protection circuit		Varistor	

Accessories and Spare Parts

For 3RT, 3RH Contactors and Contactor Relays

Accessories for 3RT, 3RH contactors
and contactor relays



Contactors	Type	3RH19 24, 3TX7 090 Coupling links for mounting on contactors acc. to IEC 60947/EN 60947	
Load side			
Mechanical endurance	In million operating cycles		20
Electrical endurance at I_e	In million operating cycles		0.1
Switching frequency	Operating cycles	h^{-1}	5000
Make-time		ms	Approx. 7
Break-time		ms	Approx. 4
Bounce time		ms	Approx. 2
Contact material			AgSnO
Switching voltage		V AC/DC	24 ... 250
Permissible residual current of the electronics (for 0 signal)		mA	2.5
Rated operational currents ¹⁾			
Continuous thermal current I_{th}		A	6
Rated operational currents I_e Acc. to utilization categories EN 60947			
• AC-15	- At 24 V	A	3
	- At 110 V	A	3
	- At 230 V	A	3
• DC-13	- At 24 V	A	1
	- At 110 V	A	0.2
	- At 230 V	A	0.1
Switching current with resistive load to EN 60255 (relay standard) and EN 60947			
• AC-12	- At 24 V	A	6
	- At 110 V	A	6
	- At 230 V	A	6
• DC-12	- At 24 V	A	6
	- At 110 V	A	0.3
	- At 230 V	A	0.2 ¹⁾

¹⁾ Capacitive loads can result in micro-weldings on the contacts.

Accessories and Spare Parts For 3T Contactors and Contactor Relays

Accessories for
3TB, 3TC, 3TF, 3TG, 3TK contactors

Technical specifications



For 3TF2 contactors		Auxiliary switch block	
Type		3TX4 4...-..	
General data			
Permissible mounting position	AC and DC operation	Any	
Mechanical endurance		10 million	
• AC operation	Operating cycles	10 million	
• DC operation	Operating cycles	30 million	
Rated insulation voltage U_i (degree of pollution 3)		 For screw terminals	
	V	500	
Rated impulse withstand voltage U_{imp} (degree of pollution 3)		 For screw terminals	
	kV	6	
Protective separation between the coil and the contacts acc. to EN 60947-1, Appendix N	V	Up to 300	
Positively-driven operation		ZH1/457, SUVA	
• 3TF2 basic unit or complete unit		ZH1/457, SUVA	
• 3TF20 basic unit with 3TX4 4 auxiliary switch block	- Upper level - Lower level - Different levels	ZH1/457, SUVA ZH1/457, SUVA SUVA	
Permissible ambient temperature¹⁾			
• During operation	°C	-25 ... +55	
• During storage	°C	-55 ... +80	
Degree of protection acc. to EN 60947-1 Appendix C		IP20 for screw terminals	
Touch protection acc. to EN 50274		Finger-safe for screw terminals	
Shock resistance			
• Rectangular pulse	- AC operation - DC operation	<i>g/ms</i> <i>g/ms</i>	7/5 and 4/10 10/5 and 6/10
• Sine pulse	- AC operation - DC operation	<i>g/ms</i> <i>g/ms</i>	9/5 and 6/10 13/5 and 8/10
Short-circuit protection			
Short-circuit protection			
Fuse links gL/gG LV HRC 3NA, DIAZED 5SB, NEOZED 5SE	A	6	
Weld-free protection at $I_k \geq 1$ kA			

¹⁾ Applies to 50/60 Hz coil:
Operating range at 60 Hz: $0.85 \dots 1.1 \times U_N$;
at 50 Hz, $1.1 \times U_N$, side-by-side mounting and 100 % ON period the max.
ambient temperature is +40 °C.

Accessories and Spare Parts For 3T Contactors and Contactor Relays

Accessories for 3TH contactor relays

Technical specifications

For 3TH2 contactor relays			Auxiliary switch block
Type			3TX4 4...-..
General data			
Permissible mounting position	AC and DC operation		Any
Mechanical endurance			
• AC operation		Operating cycles	10 million
• DC operation		Operating cycles	30 million
Rated insulation voltage U_i (degree of pollution 3)			 For screw terminals
	V		500
Rated impulse withstand voltage U_{imp} (degree of pollution 3)			 For screw terminals
	kV		6
Protective separation between the coil and the contacts acc. to EN 60947-1, Appendix N		V	Up to 300
Positively-driven operation			
• 3TH2 basic unit or complete unit			ZH1/457, SUVA
• 3TH20 basic unit with 3TX4 4 auxiliary switch block	- Upper level - Lower level - Different levels		ZH1/457, SUVA ZH1/457, SUVA SUVA
Permissible ambient temperature¹⁾			
• During operation		°C	-25 ... +55
• During storage		°C	-55 ... +80
Degree of protection acc. to EN 60947-1 Appendix C			IP20 for screw terminals
Touch protection acc. to EN 50274			Finger-safe for screw terminals
Shock resistance			
• Rectangular pulse	- AC operation - DC operation	<i>g</i> /ms <i>g</i> /ms	7/5 and 4/10 10/5 and 6/10
• Sine pulse	- AC operation - DC operation	<i>g</i> /ms <i>g</i> /ms	9/5 and 6/10 13/5 and 8/10
Short-circuit protection			
Short-circuit protection			
Fuse links gL/gG LV HRC 3NA, DIAZED 5SB, NEOZED 5SE		A	6
Weld-free protection at $I_k \geq 1$ kA			

¹⁾ Applies to 50/60 Hz coil
Operating range at 60 Hz: $0.85 \dots 1.1 \times U_N$;
at 50 Hz, $1.1 \times U_N$, side-by-side mounting and 100 % ON period the max.
ambient temperature is +40 °C.

Controls – Contactors and Contactor Assemblies

Project planning aids

Overview

Dimensional drawings

3RA13	3/200 ... 3/202
3RA14	3/203, 3/204
3RA19	3/199, 3/200
3RH11	3/188, 3/191
3RH14	3/191
3RH19	3/196, 3/197
3RS18	3/216
3RT10	3/179 ... 3/184, 3/188 ... 3/190
3RT12	3/185
3RT13	3/185
3RT14	3/181, 3/183, 3/184
3RT15	3/186
3RT16	3/187
3RT19	3/193 ... 3/196, 3/198, 3/204
3TB5	3/207, 3/212
3TC4	3/210, 3/212
3TC5	3/210
3TC7	3/211
3TD68	3/207
3TE68	3/207
3TF2	3/213
3TF6	3/205
3TG10	3/204
3TH2	3/215, 3/216
3TH4	3/192
3TK1	3/208, 3/209
3TK2	3/214
3TX2	3/211
3TX4	3/192, 3/213 ... 3/215
3TX7	3/192, 3/206, 3/217
LZS/LZX	3/218 ... 3/220

Schematics

3RA13	3/237
3RA14	3/238
3RH11	3/226, 3/231, 3/232, 3/235, 3/236
3RH14	3/232, 3/235
3RH19	3/222 ... 3/224, 3/227 ... 3/230
3RS18	3/249
3RT10	3/221, 3/226 ... 3/228, 3/231
3RT12	3/221
3RT13	3/221, 3/228
3RT14	3/221, 3/227
3RT15	3/221, 3/228
3RT16	3/225, 3/230
3RT19	3/222 ... 3/225, 3/229, 3/230
3TB5	3/240, 3/243
3TC4	3/242, 3/244
3TC5	3/242, 3/244
3TC7	3/242, 3/244
3TD68	3/240
3TE68	3/241
3TF2	3/245
3TF6	3/239, 3/243
3TG10	3/239, 3/243
3TH2	3/246
3TH4	3/233, 3/234
3TK1	3/241, 3/244
3TK2	3/245
3TX4	3/245, 3/246
3TX7	3/239, 3/247 ... 3/249
3TY6	3/240
3TY7	3/239
LZS/LZX	3/250, 3/251

Dimensional drawings

3RT10 contactors, 3-pole

3RT10 1 contactors, size S00

Screw terminals
with surge suppressor, auxiliary switch block and mounted overload relay

Lateral distance to
grounded components = 6 mm

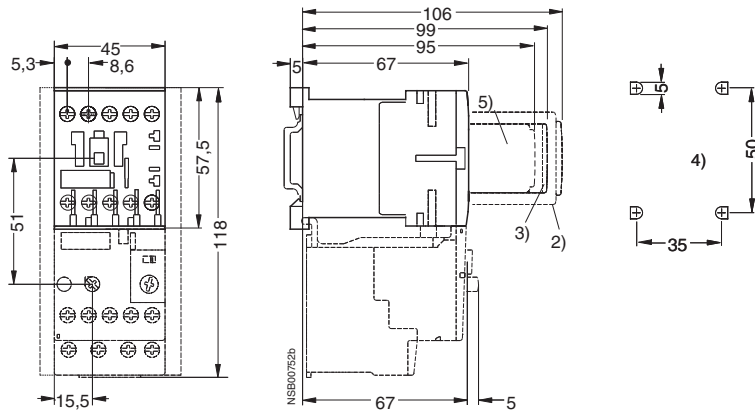

- 2) Auxiliary switch block
(also solid-state compatible version
3RH19 11- . NF . .)
- 3) Surge suppressor
(also 3RT19 16-1GA00
additional load module)
- 4) Drilling pattern
- 5) Auxiliary switch block
1-pole

3RT10 1 contactors, size S00

Cage Clamp terminals with auxiliary switch block

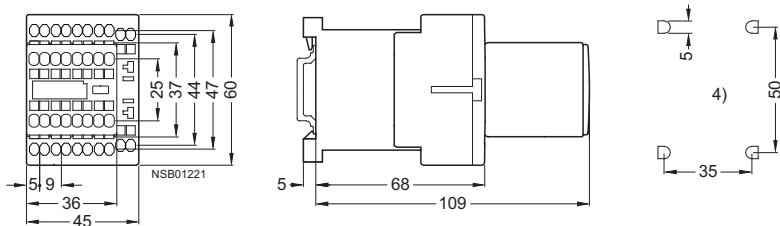

3RT10 2 contactors, 3RT10 2 coupling relays, size S0

Screw terminals
with surge suppressor, auxiliary switch blocks and mounted overload relay

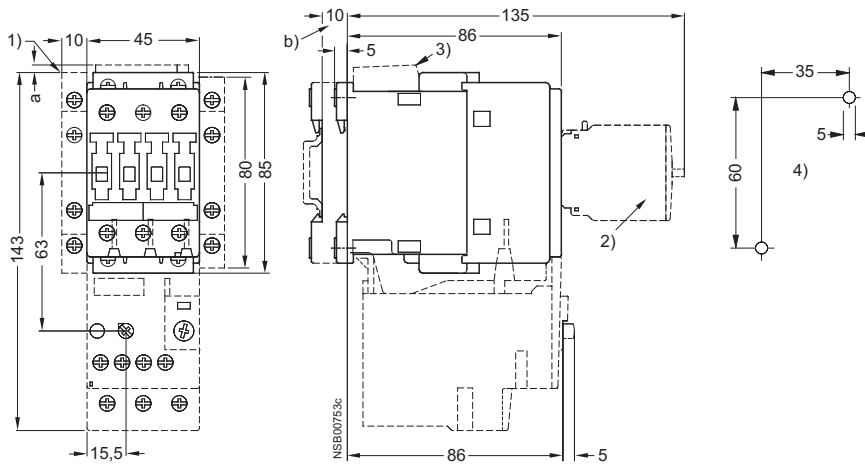

- For size S0:
- a = 3 mm at < 240 V
 - a = 7 mm at > 240 V
 - b = DC 10 mm deeper than AC
- 1) Auxiliary switch block, laterally mountable
 - 2) Auxiliary switch block, mountable on the front,
1-, 2- and 4-pole (also solid-state compatible
version 3RH19 21- . FE22)
 - 3) Surge suppressor
 - 4) Drilling pattern

Project planning aids

3RT10 contactors, 3-pole

3RT10 2 contactors, 3RT10 2 coupling relays, size S0

Cage Clamp terminals
with surge suppressor, auxiliary switch blocks and mounted overload relay

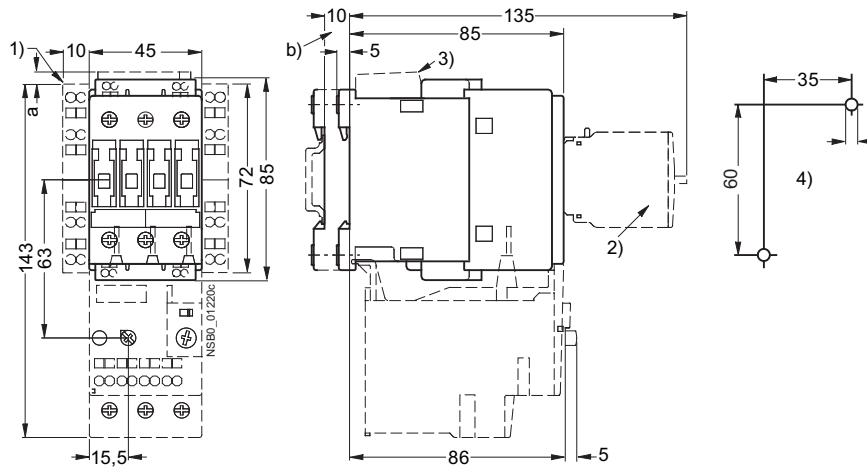

For size S0:

- a = 0 mm with varistor < 240 V, diode assembly
- a = 3.5 mm with varistor > 240 V
- a = 17 mm with RC element
- b = DC 10 mm deeper than AC
- 1) Auxiliary switch block, laterally mountable
- 2) Auxiliary switch block, mountable on the front, (1-, 2- and 4-pole)
- 3) Surge suppressor
- 4) Drilling pattern

3RT10 3 contactors, size S2

Screw terminals
with surge suppressor, auxiliary switch blocks and mounted overload relay

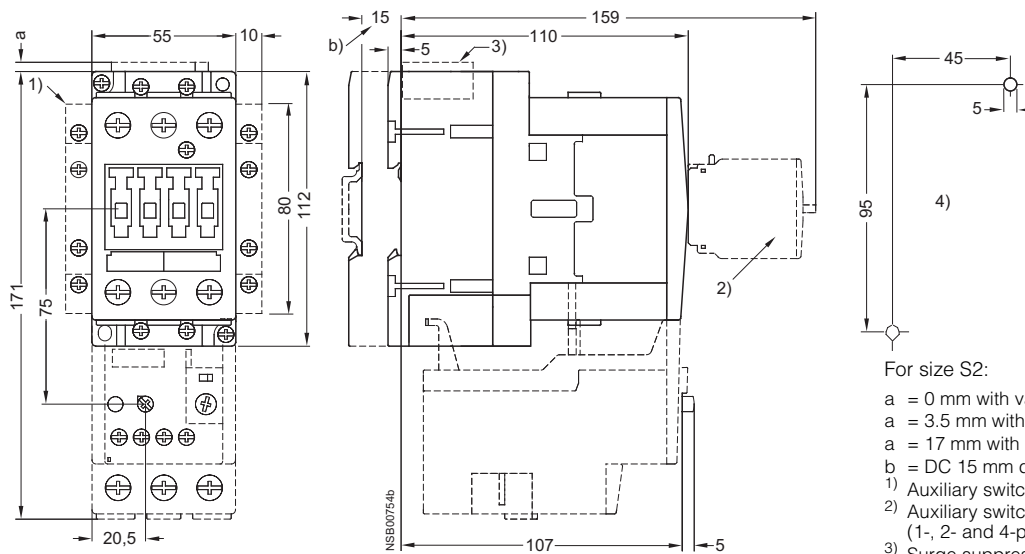

For size S2:

- a = 0 mm with varistor < 240 V, diode assembly
- a = 3.5 mm with varistor > 240 V
- a = 17 mm with RC element
- b = DC 15 mm deeper than AC
- 1) Auxiliary switch block, laterally mountable
- 2) Auxiliary switch block, mountable on the front, (1-, 2- and 4-pole)
- 3) Surge suppressor
- 4) Drilling pattern

3RT10 and 3RT14 contactors, 3-pole**3RT10 3 contactors, size S2**

Cage Clamp terminals
with surge suppressor, auxiliary switch blocks and mounted overload relay

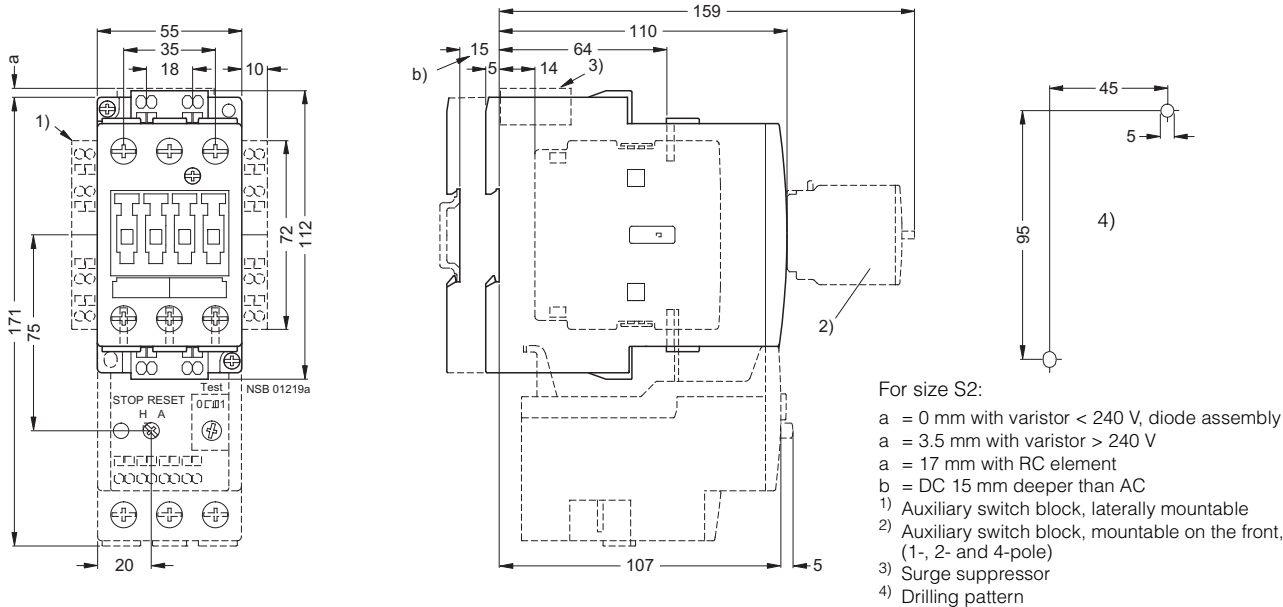
**3RT10 4, 3RT14 46 contactors, size S3**

Screw terminals
with surge suppressor, auxiliary switch blocks and mounted overload relay

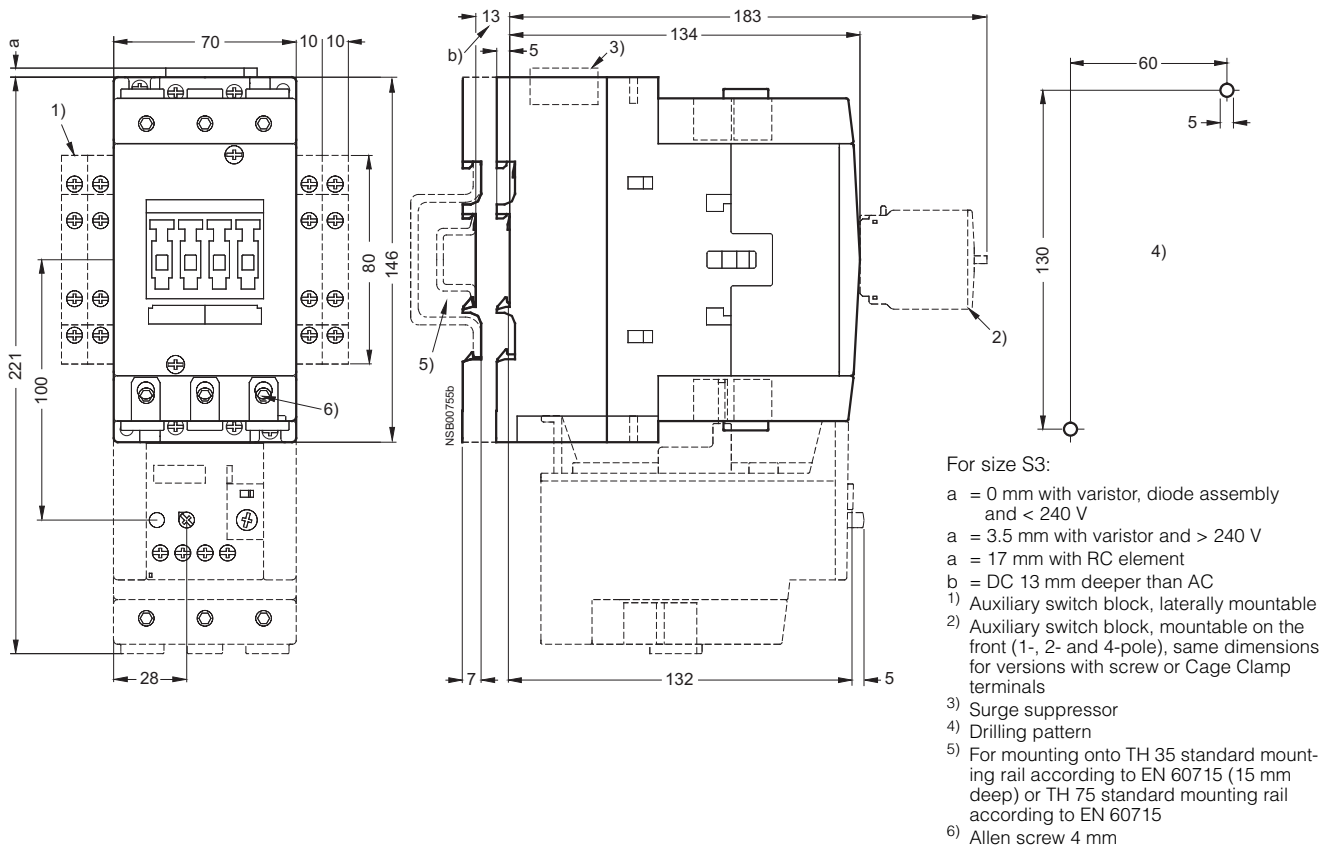

Project planning aids

3RT10 contactors, 3-pole

3RT10 4 contactors, size S3

Cage Clamp terminals
with surge suppressor, auxiliary switch blocks and mounted overload relay

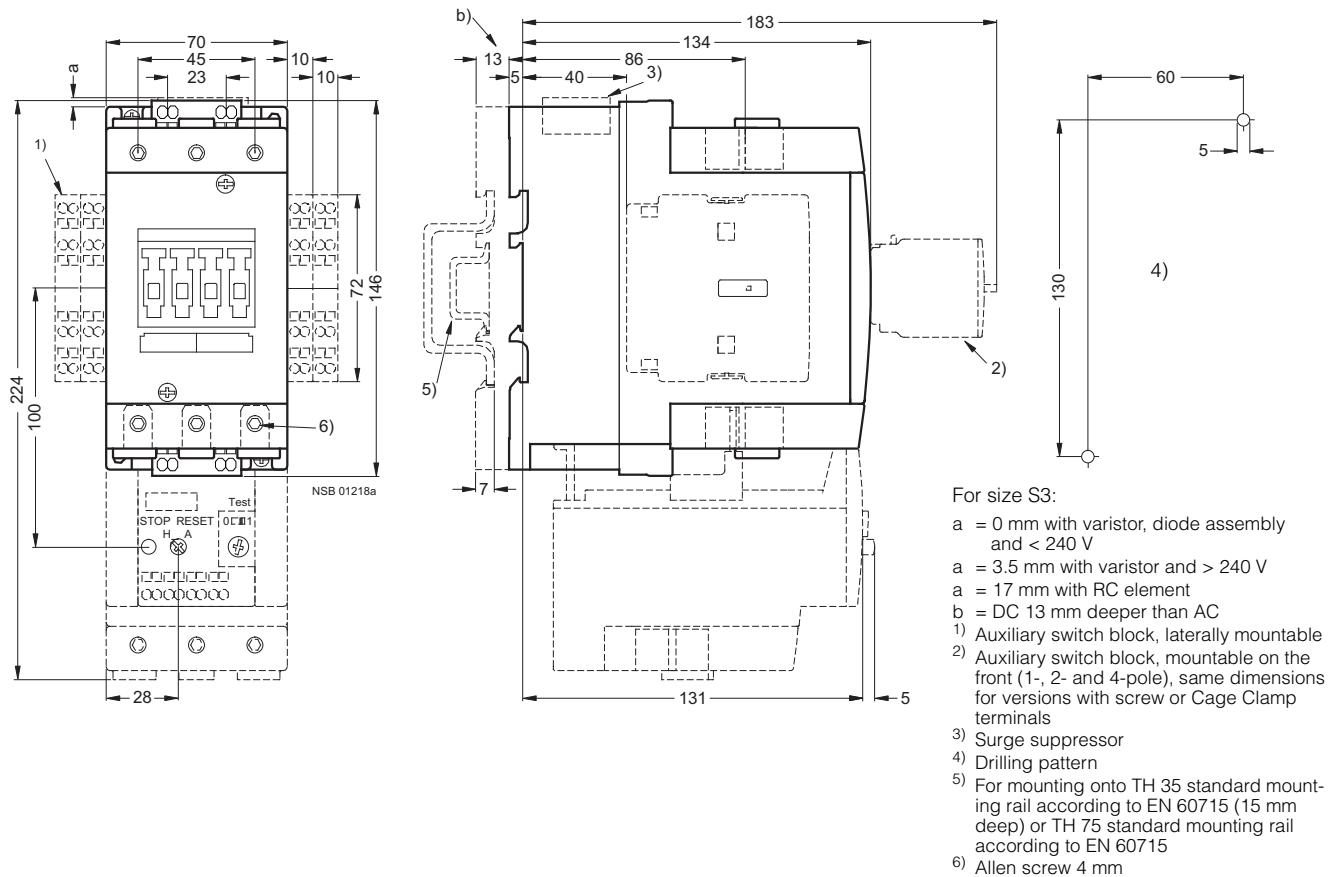

3RT10 coupling relays, size S00

with surge suppressor

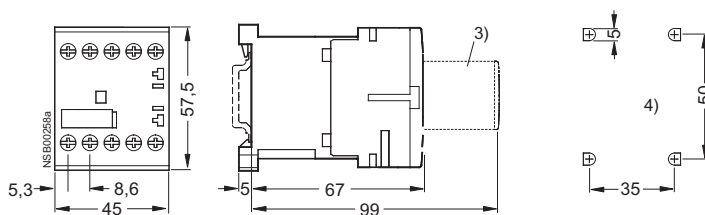

Deviating dimensions for coupling relays with Cage Clamp terminals:
Height: 60 mm

- 3) Surge suppressor
- 4) Drilling pattern

3RT10 and 3RT14 contactors, 3-pole**3RT10 5, 3RT14 5 contactors, size S6**

with lateral and front mounted auxiliary switch block
mounted overload relay and box terminals,
lateral solid-state module with remaining lifetime indicator

Distance from grounded parts

Lateral: 10 mm

Front: 20 mm

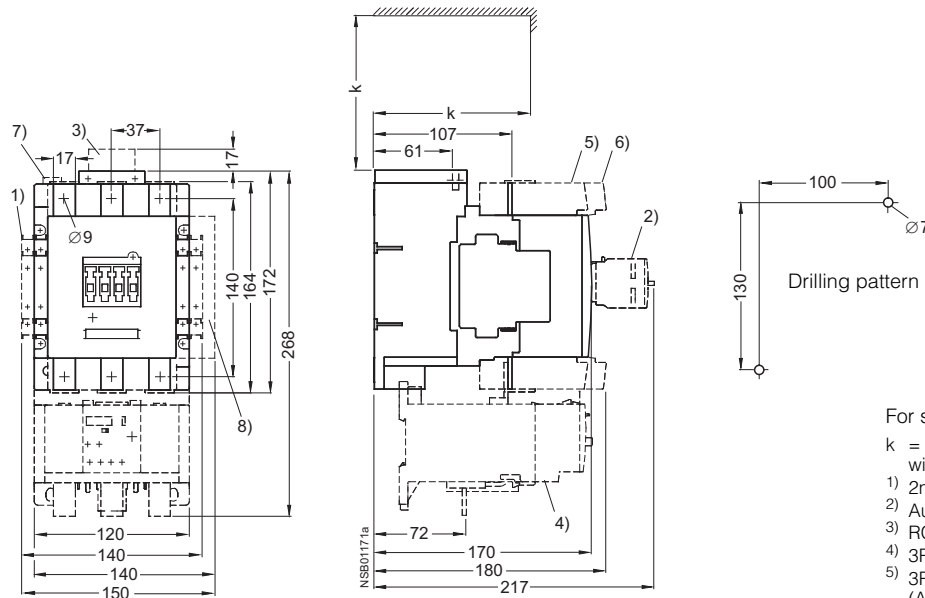

For size S6:

$k = 120$ mm (minimum clearance for removing the withdrawable coil)

- 1) 2nd auxiliary switch block, lateral
- 2) Auxiliary switch block, mountable on the front
- 3) RC element
- 4) 3RB20 overload relay, mounted
- 5) 3RT19 55-4G box terminal block (Allen screw 4 mm)
- 6) 3RT19 56-4G box terminal block (Allen screw 4 mm)
- 7) PLC connection 24 V DC and changeover switch (for 3RT1...-N)
- 8) Solid-state module with remaining lifetime indicator (auxiliary switch block not mountable on right-hand side)

Controls – Contactors and Contactor Assemblies

Project planning aids

3RT10 and 3RT14 contactors, 3-pole

3RT10 6, 3RT14 6 contactors, size S10

with lateral and front mounted auxiliary switch block
 mounted overload relay and box terminals,
 lateral solid-state module with remaining lifetime indicator

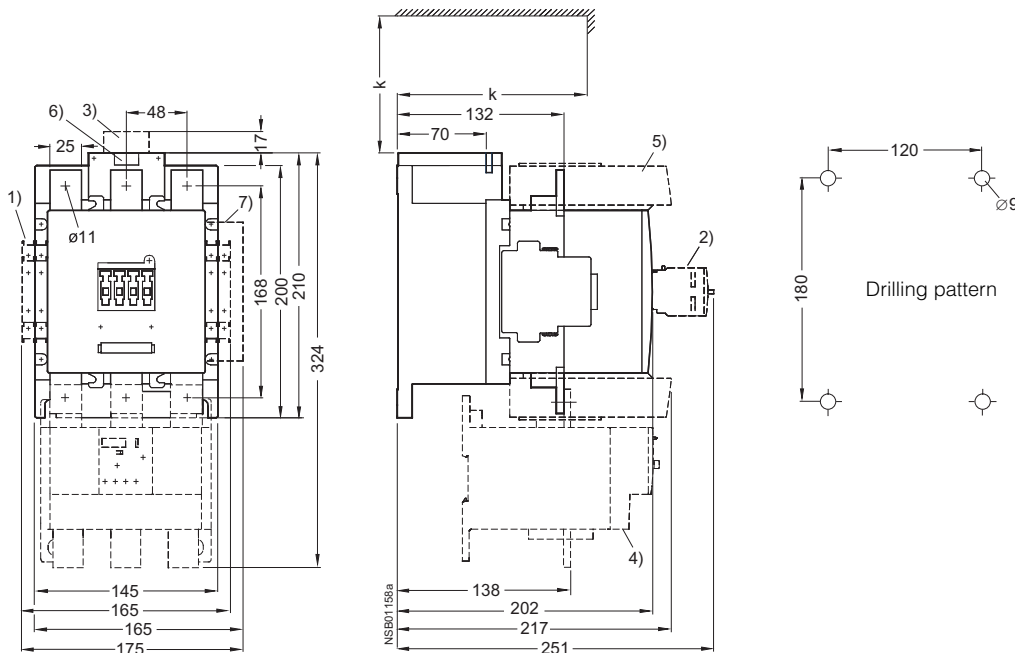

3RT10 7, 3RT14 7 contactors, size S12

with lateral and front mounted auxiliary switch block
 mounted overload relay and box terminals,
 lateral solid-state module with remaining lifetime indicator

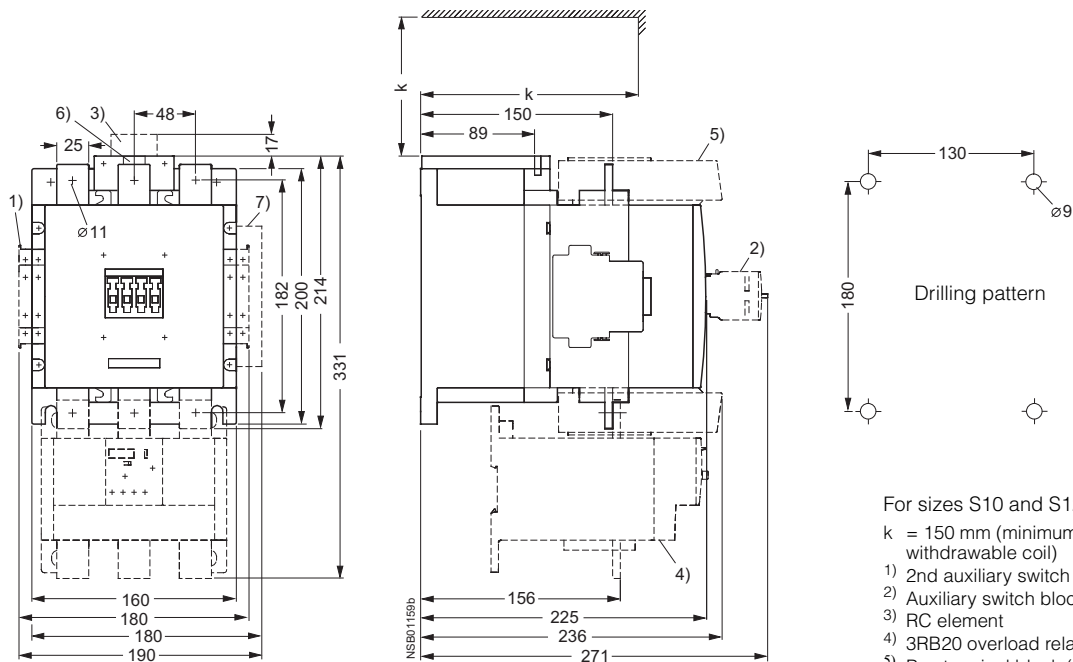

For sizes S10 and S12:
 Distance from grounded parts
 Lateral: 10 mm
 Front: 20 mm

- For sizes S10 and S12:
 k = 150 mm (minimum clearance for removing the withdrawable coil)
- 1) 2nd auxiliary switch block, lateral
 - 2) Auxiliary switch block, mountable on the front
 - 3) RC element
 - 4) 3RB20 overload relay, mounted
 - 5) Box terminal block (Allen screw 6 mm)
 - 6) PLC connection 24 V DC and changeover switch (for 3RT1...-N)
 - 7) Solid-state module with remaining lifetime indicator (auxiliary switch block not mountable on right-hand side)

3

3RT12 vacuum contactors, 3-pole

3RT12 6 vacuum contactors, size S10

with lateral auxiliary switch block,
mounted overload relay and box terminals

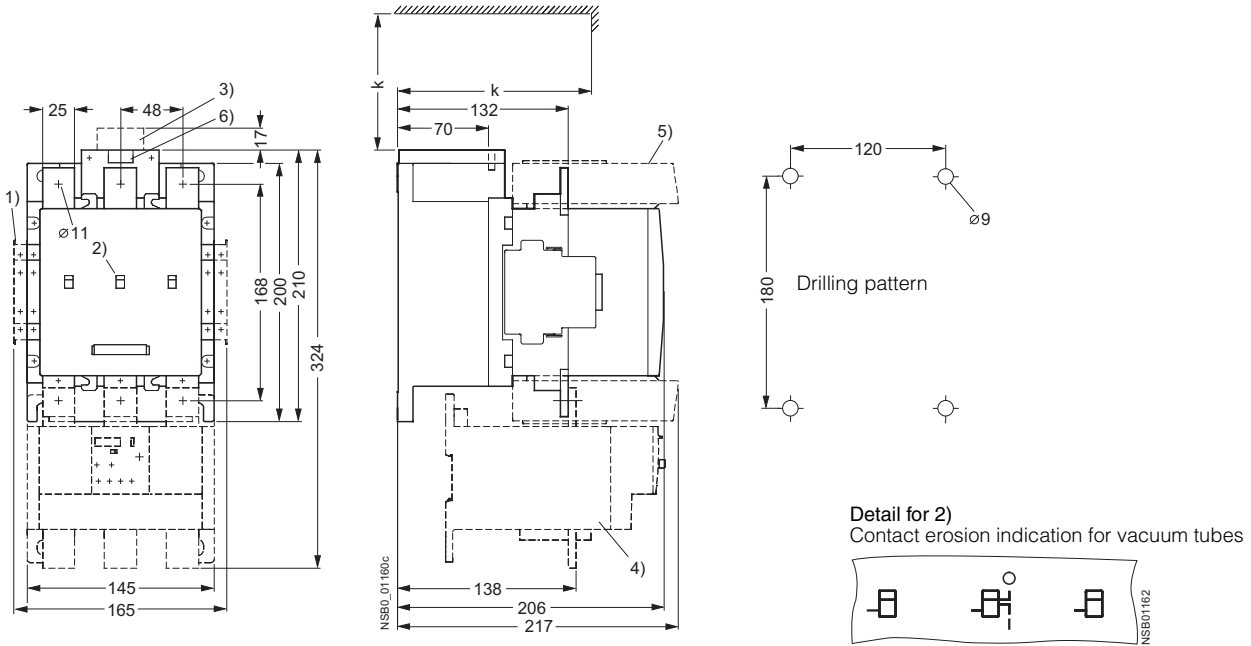

3RT12 7 vacuum contactors, size S12

with lateral auxiliary switch block,
mounted overload relay and box terminals

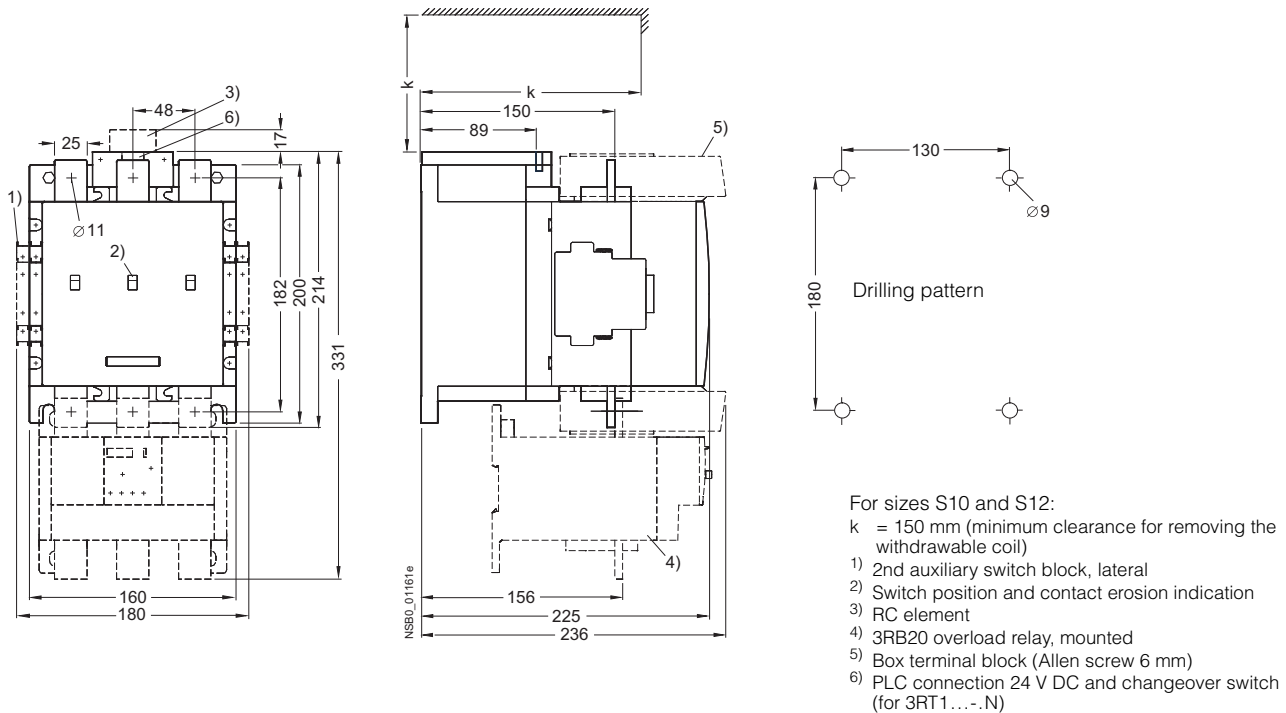

Project planning aids

3RT13 and 3RT15 contactors, 4-pole

3RT13 1 and 3RT15 1 contactors, size S00,

Screw terminals
with surge suppressor and auxiliary switch block

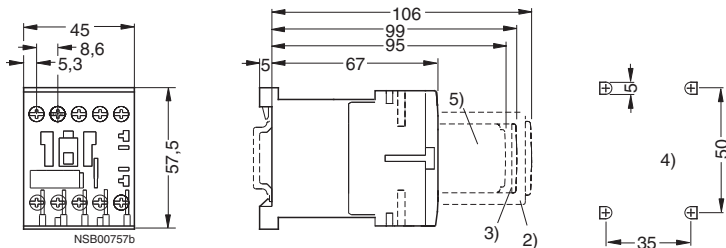

Lateral distance to
grounded components = 6 mm

For size S00:

Deviating dimensions for contactors
with Cage Clamp terminals:
Height: 60 mm
Mounting depth with auxiliary switch block:
110 mm

- 2) Auxiliary switch block
(also solid-state compatible version
3RH19 11-.N...)
- 3) Surge suppressor
(also 3RT19 16-1GA00
additional load module)
- 4) Drilling pattern
- 5) Auxiliary switch block
1-pole

3RT13 2 and 3RT15 2 contactors, size S0

with surge suppressor and auxiliary switch block

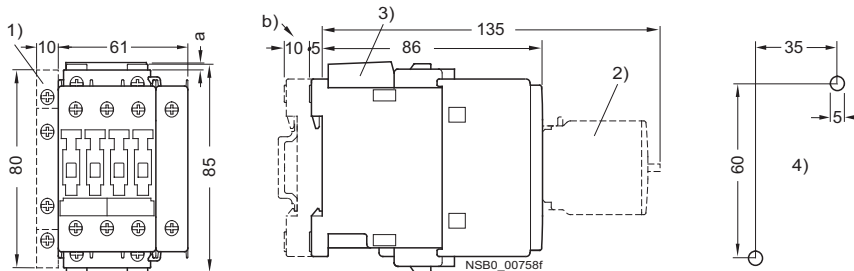

For size S0:

a = 3 mm at < 250 V and mounting of
surge suppressor
a = 7 mm at > 250 V and mounting of
surge suppressor

- b = DC 10 mm deeper than AC
- 1) Auxiliary switch block, laterally mountable
(left)
 - 2) Auxiliary switch block, mountable on the
front
 - 3) Surge suppressor
 - 4) Drilling pattern

3RT13 3 and 3RT15 3 contactors, size S2

with surge suppressor and auxiliary switch block

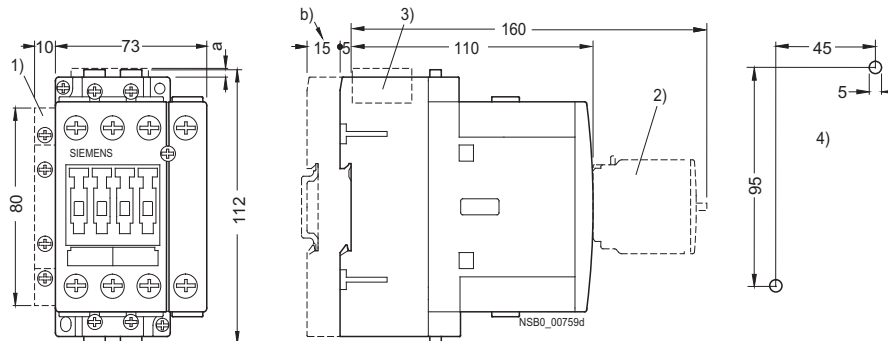

For sizes S2 and S3:

a = 0 mm with varistor < 240 V
a = 3.5 mm with varistor > 240 V
a = 17 mm with RC element and diode
assembly

- b = S2: DC 15 mm deeper than AC
S3: DC 13 mm deeper than AC
- 1) Auxiliary switch block, laterally mountable
(right or left)
 - 2) Auxiliary switch block, mountable on the
front, (1-, 2- and 4-pole, also 3RH19 21-
1FE22 solid-state compatible version)
 - 3) Surge suppressor
 - 4) Drilling pattern
 - 5) For mounting onto TH 35 standard mount-
ing rail according to EN 60715 (15 mm
deep) or for size S3 also to TH 75 standard
mounting rail according to EN 60715
 - 6) Allen screw 4 mm

3RT13 4 contactors, size S3

with surge suppressor and auxiliary switch block

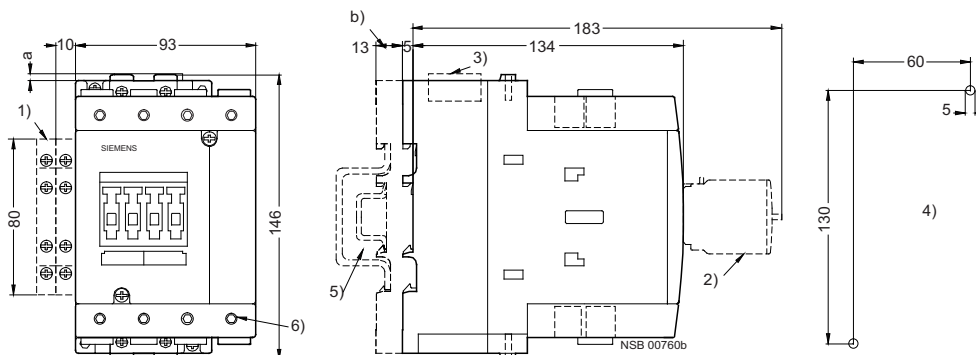

3RT16 capacitor contactors

3RT16 17 capacitor contactors, size S00

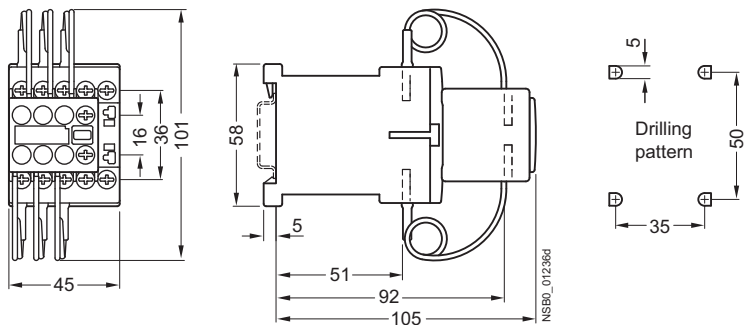

3RT16 27 capacitor contactors, size S0

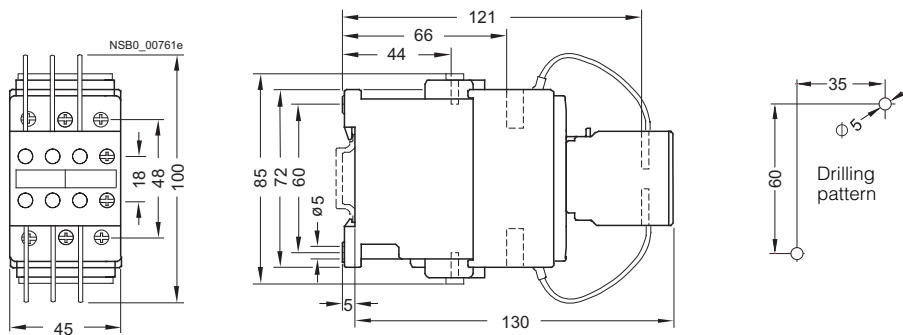

3RT16 47 capacitor contactors, size S3

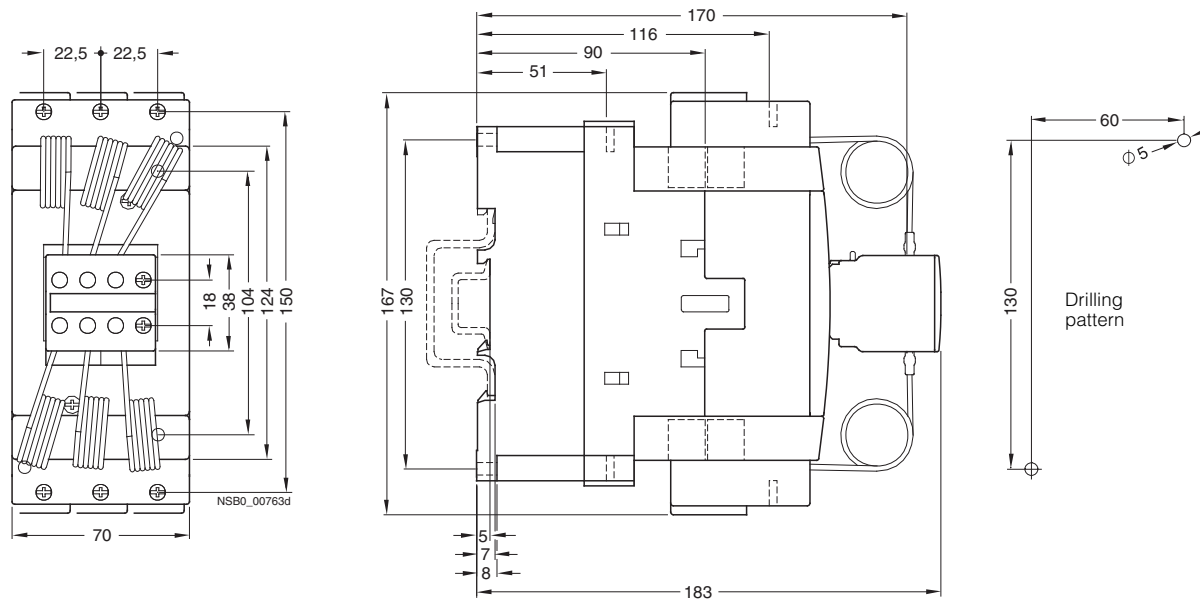

Controls – Contactors and Contactor Assemblies

Project planning aids

Contactors with extended operating range 0.7 to $1.25 \times U_s$

Size S00

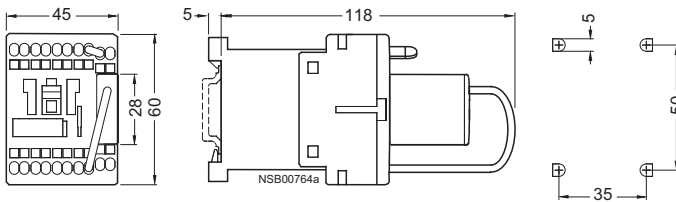

Without series resistor:

3RH11 22-2KB40

-2KF40

3RT10 17-2KB41

-2KF41

-2KB42

-2KF42

For dimensions see page 3/179 (size S00)

Size S0¹⁾

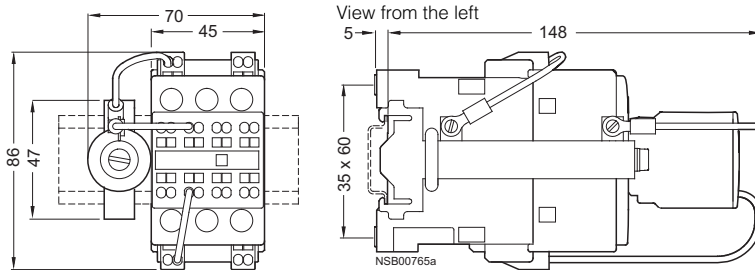

Without series resistor:

3RT10 25-3KB40

-3KF40

3RT10 26-3KB40

-3KF40

For dimensions see page 3/180 (size S0)

Size S2¹⁾

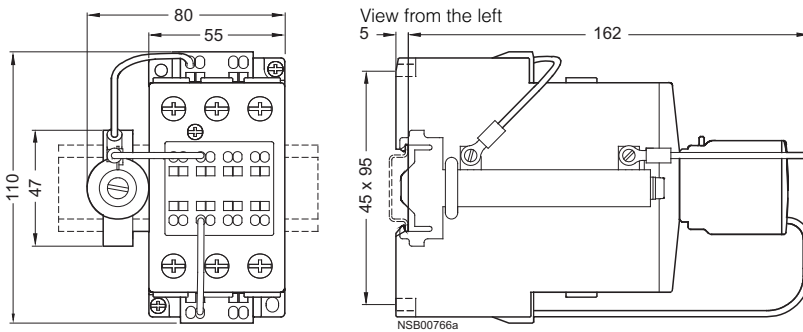

Size S3¹⁾

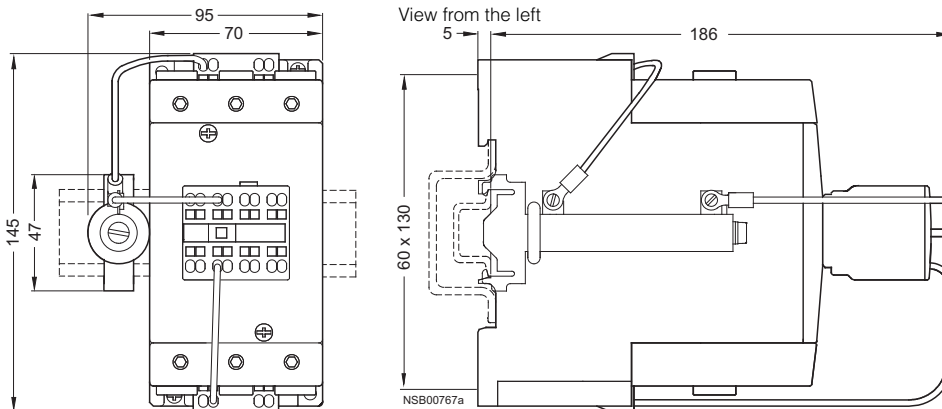

¹⁾ Sizes S0 to S3: Contactor series resistor must be connected by customer.
The series resistor is equipped with the necessary connecting cables.

Contactors with extended operating range 0.7 to 1.25 x U_s**3RT10 2 . -3X . 40-0LA2 contactors, size S0**

Cage Clamp terminals

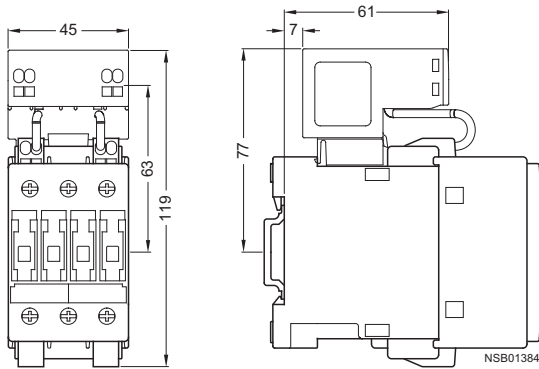
**3RT10 2 . -1X . 40-0LA2 contactors, size S0**

Screw terminals

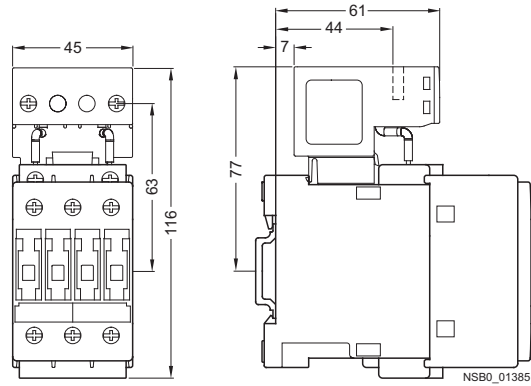
**3RT10 3 . -3X . 40-0LA2 contactors, size S2**

Cage Clamp terminals

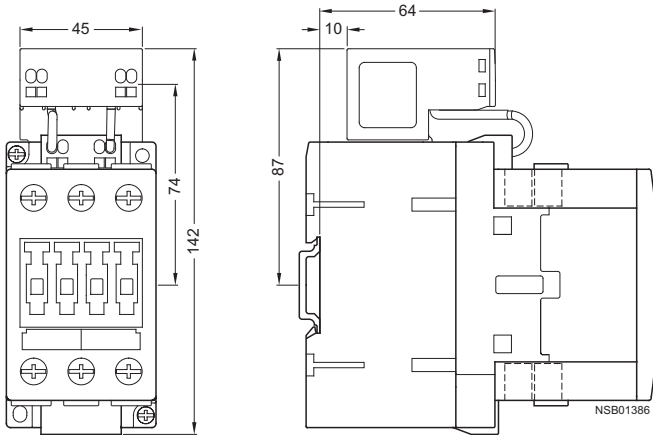
**3RT10 3 . -1X . 40-0LA2 contactors, size S2**

Screw terminals

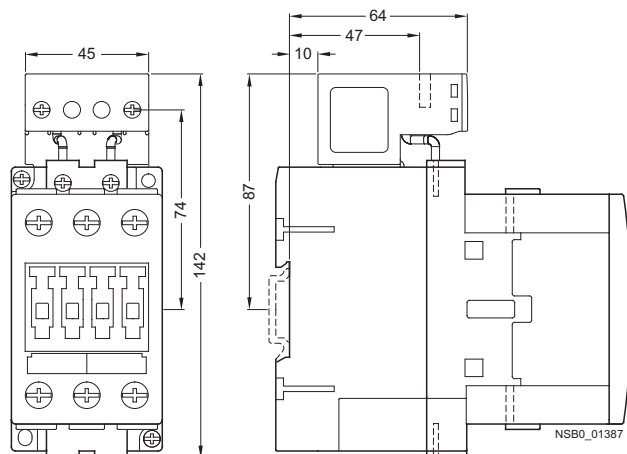

All dimensions not mentioned are identical to those of the contactors with DC operation (see page 3/180 to page 3/182).

Project planning aids

*Contactors with extended operating range 0.7 to 1.25 x U_s***3RT10 4.-3X.40-0LA2 contactors, size S3**

Cage Clamp terminals

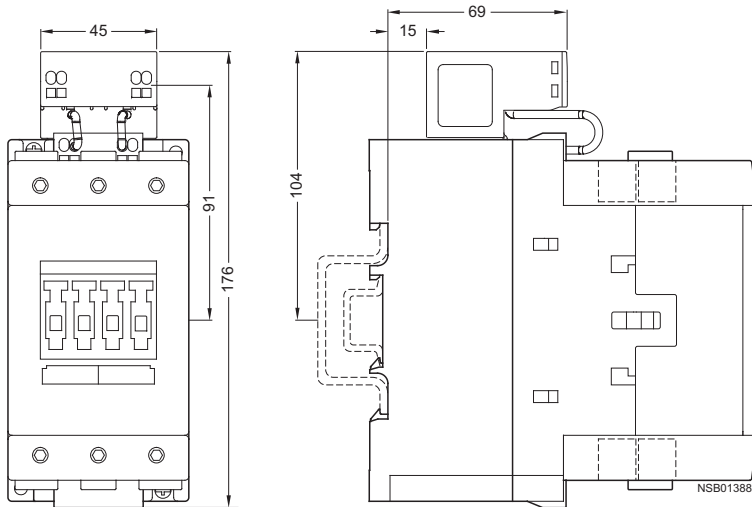
**3RT10 4.-1X.40-0LA2 contactors, size S3**

Screw terminals

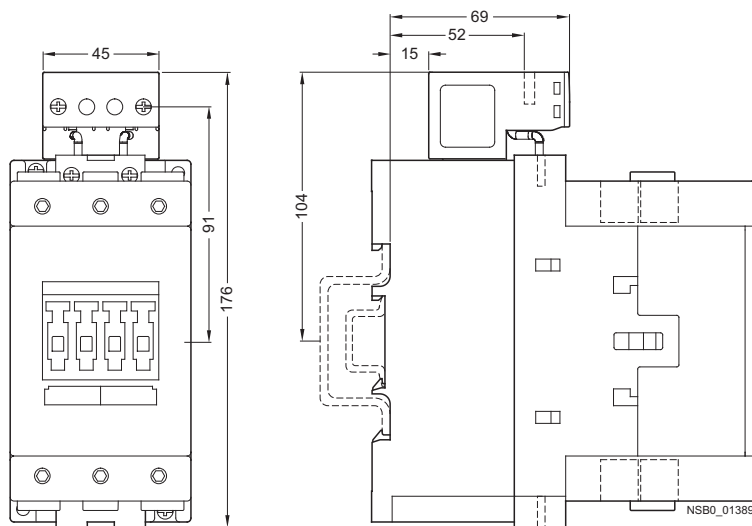

All dimensions not mentioned are identical to those of the contactors with DC operation (see page 3/180 to 3/182).

3RH11 and 3RH14 contactor relays

3RH11 contactor relays, size S00

with screw terminals,
with surge suppressor and auxiliary switch block

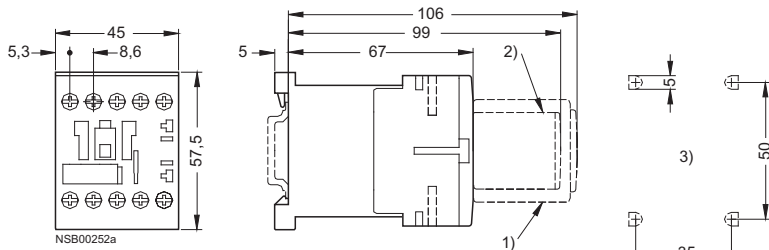

Lateral distance to grounded components = 6 mm

- 1) Auxiliary switch block
- 2) Surge suppressor
- 3) Drilling pattern

with Cage Clamp terminals,
with auxiliary switch block

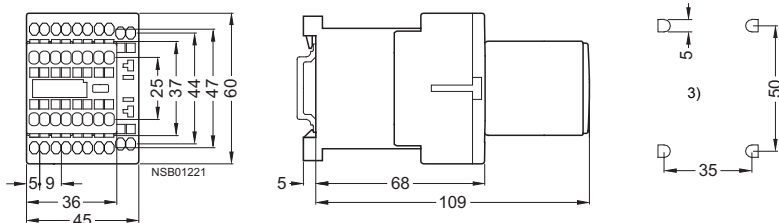

3RH14 latched contactor relays, size S00

with surge suppressor and auxiliary switch block

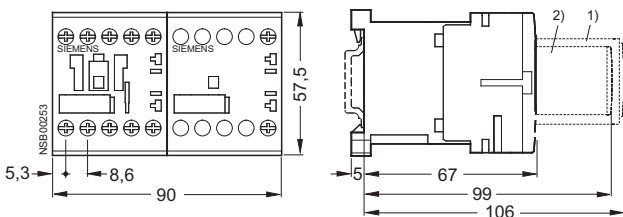

3RH11 coupling relays

3RH11 coupling relays, size S00

with screw terminals,
with surge suppressor



- 1) Surge suppressor
- 2) Drilling pattern

Deviating dimensions for coupling relays
with Cage Clamp terminals:
Height: 60 mm

Project planning aids

3TH42/3TH43

AC operation

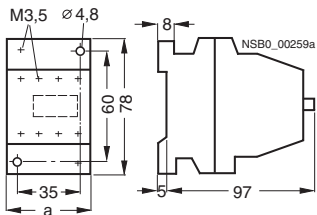

Contactor a type	
3TH42	45
3TH43	55

DC operation

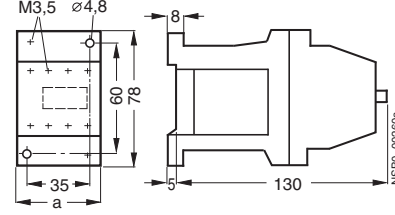

Contactor a type	
3TH42	45
3TH43	55

Accessories for 3TH42/3TH43 contactor relays

**3TX7 402-3 varistors,
3TX7 402-3A noise suppression diode,
3TX7 402-3D diode assemblies**

(for DC operation) for 3TH42/3TH43 contactor relays for mounting onto the coil terminals

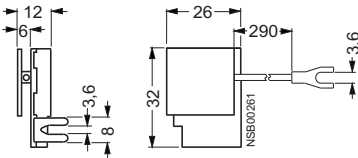

3TX7 402-3 RC elements

for 3TH42/3TH43 contactor relays for mounting onto the coil terminals

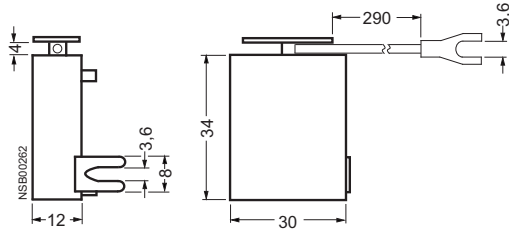

3TX4 180-0A ON-delay devices

for 3TH42/3TH43 contactor relays

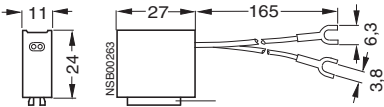

3TX4 701 OFF-delay devices

for 3TH42/3TH43 contactor relays

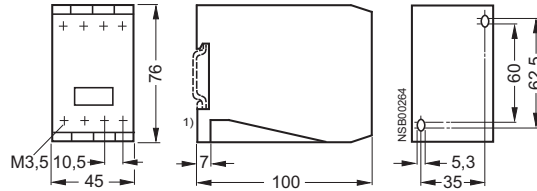

3TX4 090-0C coupling link

for mounting onto the contactor coil of 3TH42/3TH43 contactor relays, without surge suppression

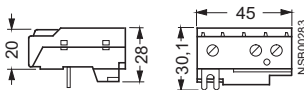

3TX4 090-0D coupling link

for mounting onto the contactor coil of 3TH42/3TH43 contactor relays with surge suppression

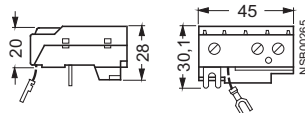

1) For 35 mm standard mounting rail.

Accessories for 3RT1 contactors

3RT19 16-2E . . . , 3RT19 16-2F . . . , 3RT19 16-2G . . .
solid-state time-delay auxiliary switch blocks
for contactors, size S00

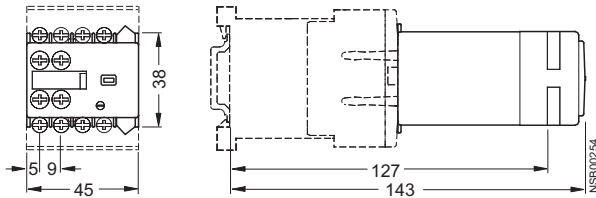

3RT19 26-2E . . . , 3RT19 26-2F . . . , 3RT19 26-2G . . .
solid-state time-delay auxiliary switch blocks
for contactors, sizes S0 to S3

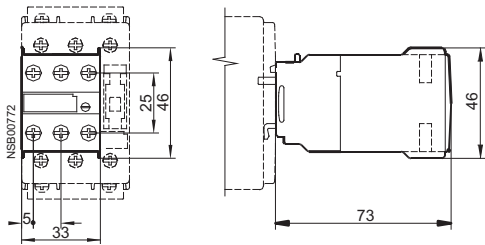

3RT19 16-2B.01
OFF-delay devices
for contactors, sizes S00 to S3

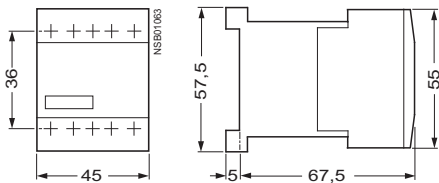

3RT19 16-4KA1
solder pin adapters
Size S00
Mounted onto 3RT10 1. contactors with 1 auxiliary contact
in the basic unit

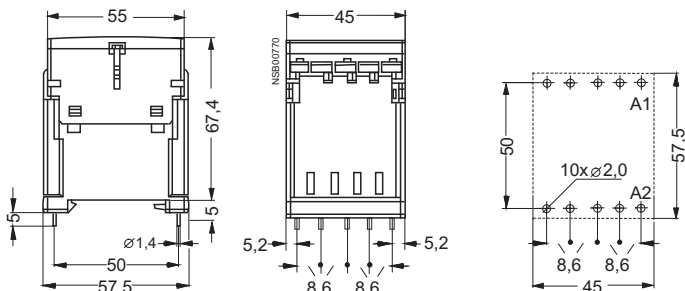

3RT19 16-2
solid-state time-delay blocks, with ON-delay
Size S00
for mounting onto the front of contactors
(the dimensions are also valid for time-delay blocks with an
OFF-delay)

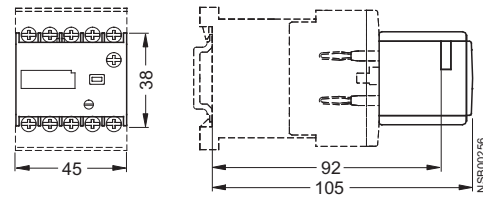

3RT19 26-2
solid-state time-delay blocks, with ON-delay
Sizes S0 to S3
for mounting onto the top of the contactors
(the dimensions are also valid for time-delay blocks with an
OFF-delay and for 3RH19 24-1GP11 coupling links)

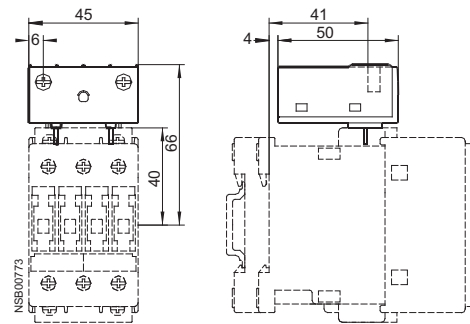

3RT19 26-2P.1
pneumatic delay block
for contactors, size S0

for mounting onto the front of 3RT1. 2 contactors

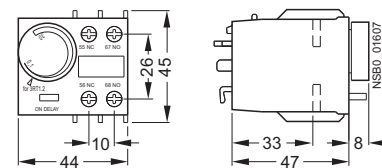

3RT19 26-4P
screw adapters
for contactors of size S0

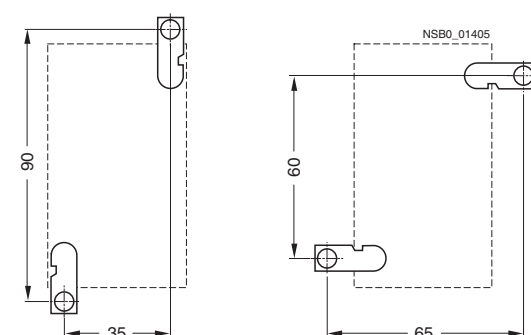

Project planning aids

Accessories for 3RT1 contactors

3RT19 16-4BB31
parallel connector
Size S00
3-pole, with terminal

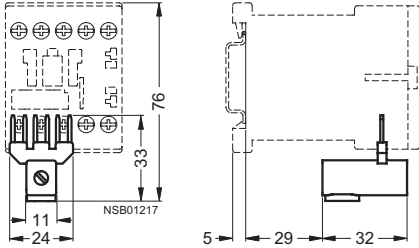

3RT19 16-4BB41
parallel connector
Size S00
4-pole, with terminal

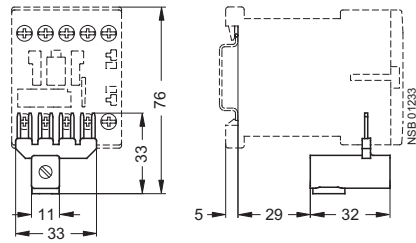

3RT19 26-4BB31
parallel connector
Size S0
3-pole, with terminal

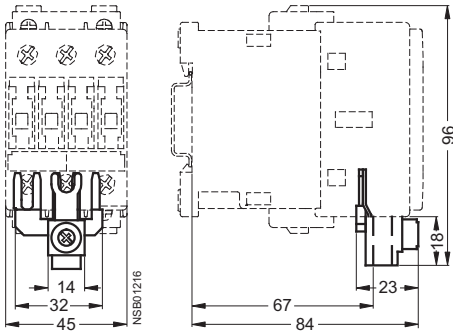

3RT19 36-4BB31
parallel connector
Size S2
3-pole, with terminal

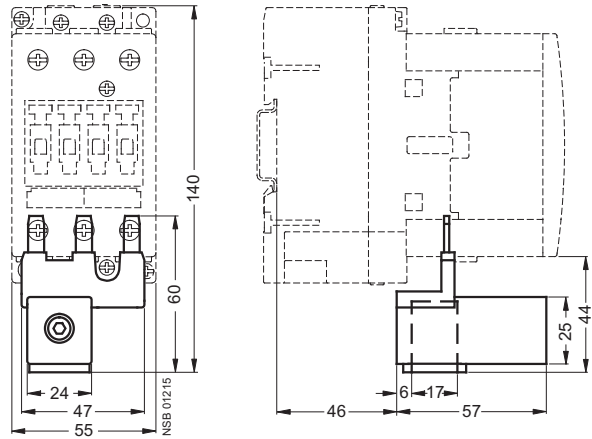

3RT19 46-4BB31
parallel connector
Size S3
3-pole, with through hole and cover for touch protection

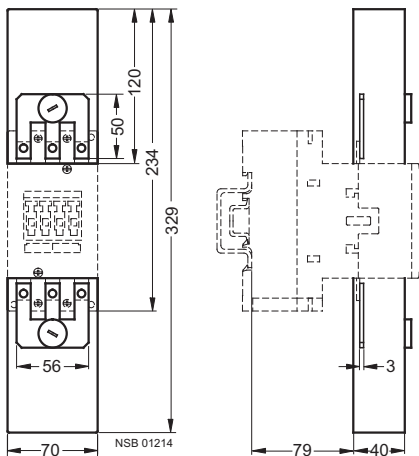

3RT19 26-3A.
mechanical latching block

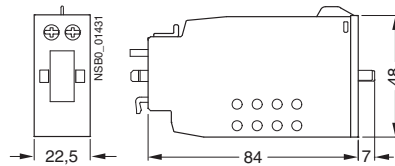

Accessories for 3RT1 contactors

3RT19 36-4EA2

terminal cover for box terminals
for size S2

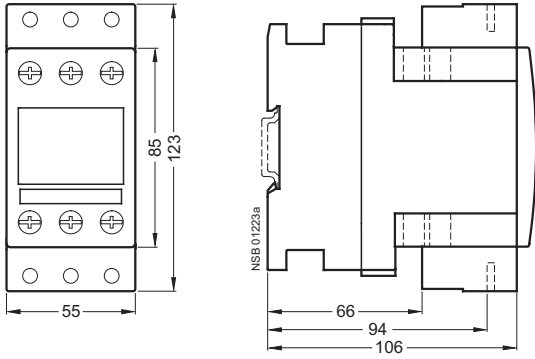

3RT19 46-4EA2

terminal cover for box terminals
for size S3

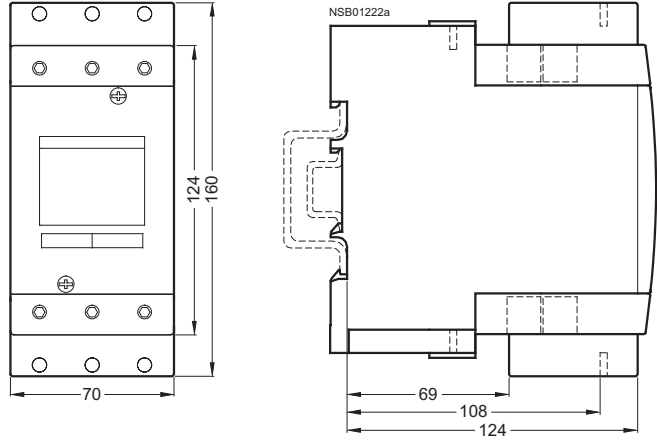

3RT19 46-4EA1

terminal cover for cable lug and busbar connection
for size S3

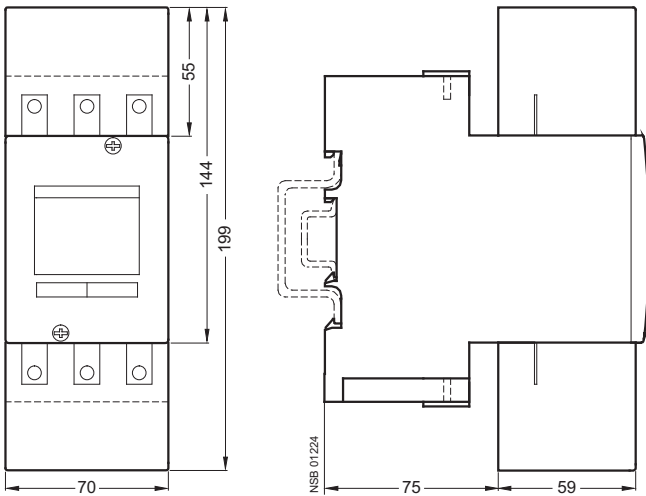

Project planning aids

Accessories for 3RT1 contactors

3RT19 46-4F

auxiliary terminals, 3-pole

Size S3

Mounted on contactor

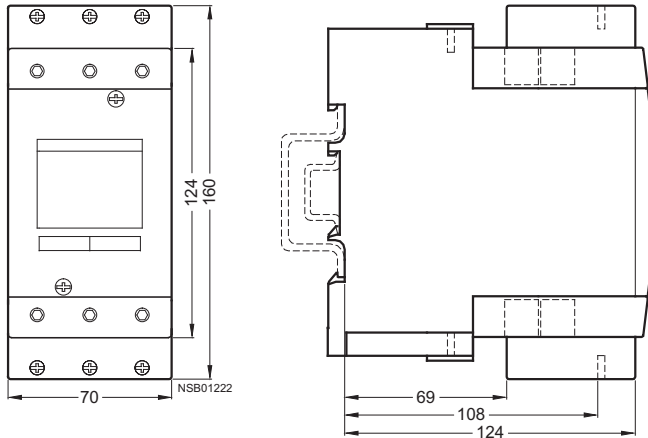
**3RH19 11-1AA... 3RH19 11-1LA...**

auxiliary switch blocks

for size S00

Screw terminals

2-pole

Cable entry from above

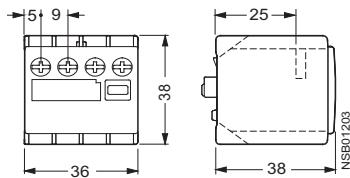
**3RH19 11-1BA... 3RH19 11-1MA...**

auxiliary switch blocks

for size S00

Screw terminals

2-pole

Cable entry from below

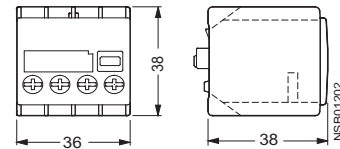
**3RH19 11-1F... 3RH19 11-1H...**

auxiliary switch blocks according to EN 50012 and EN 50005

for size S00

Screw terminals

1- to 4-pole

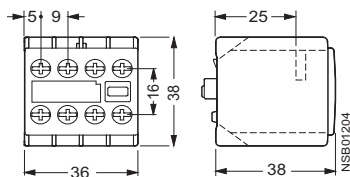
**3RH19 11-. NF...**

solid-state compatible auxiliary switch blocks according to EN 50005

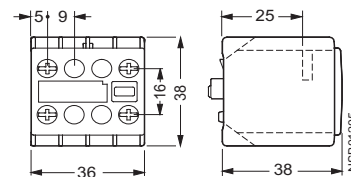
for size S00Screw terminals¹⁾**3RH19 11-2F... 3RH19 11-2H...**

auxiliary switch blocks according to EN 50005 and EN 50012

for size S00

Cage Clamp terminals

1- to 4-pole

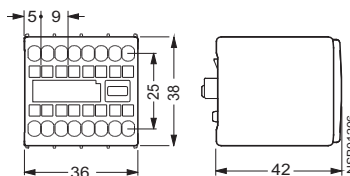
**3RH19 11-1AA... 3RH19 11-1BA...**

auxiliary switch blocks, 1-pole

for size S00

Cable entry from one side

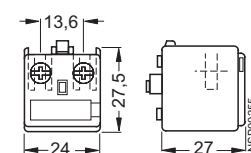

¹⁾ Deviating dimension for auxiliary switch block with Cage Clamp terminals: mounting depth 42 mm.

Accessories for 3RT1 contactors

3RH19 21- HA ... 3RH19 21- F ...
 auxiliary switch blocks according to EN 50005 and EN 50012
for sizes S0 to S12

Screw and Cage Clamp terminals
 4-pole

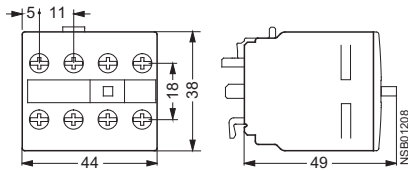

3RH19 21- C ...
 auxiliary switch block according to EN 50005 and EN 50012
for sizes S0 to S12

Screw and Cage Clamp terminals
 1-pole

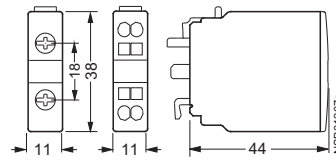

3RH19 21-1LA ...
 auxiliary switch block according to EN 50005
for sizes S0 to S12

Screw terminals
 2-pole
 Cable entry from above

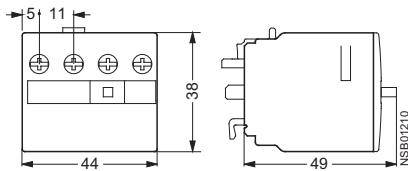

3RH19 21-1MA ...
 auxiliary switch block according to EN 50005
for sizes S0 to S12

Screw terminals
 2-pole
 Cable entry from below

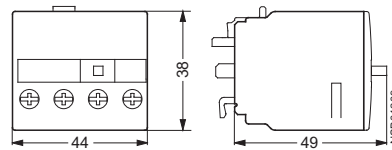

3RH19 21-1D ... 3RH19 21-1J ... 3RH19 21-1E ... 3RH19 21-1K ...
 auxiliary switch blocks, for lateral mounting
for sizes S0 to S12

Screw terminals
 2-pole

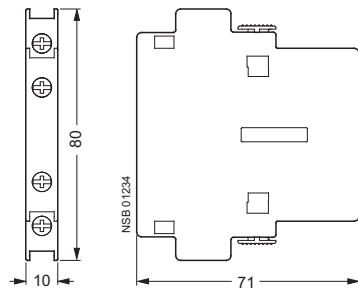

3RH19 21-2D ... 3RH19 21-2J ... 3RH19 21-2E ... 3RH19 21-2K ...
 auxiliary switch blocks, for lateral mounting
for sizes S0 to S12

Cage Clamp terminals
 2-pole

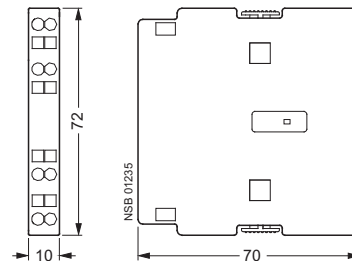

3RT19 00-4RE01 and 3RT19 16-4RD01
 connection modules for contactors with screw terminals
size S00

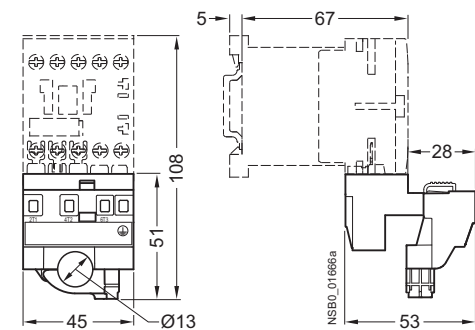

3RT19 00-4RE01 and 3RT19 26-4RD01
 connection modules for contactors with screw terminals
size S0

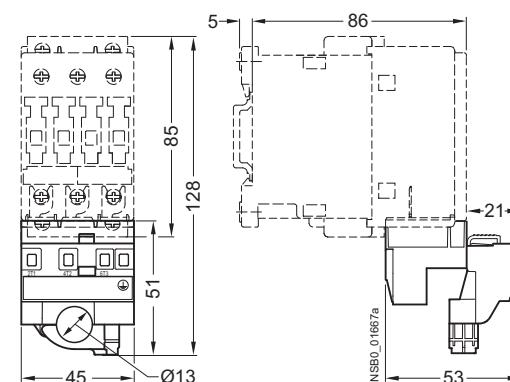

Project planning aids

Accessories for 3RT1 contactors

3RT19 66-1PV3

main current path surge suppression module
for 3RT12 vacuum contactors, sizes S10 and S12

Connected to outgoing side of contactor (2-T1/4-T2/6-T3)
using approx. 350 mm long, molded cable

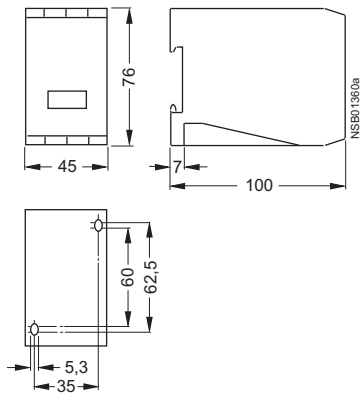

3RT19 .6-4EA1

terminal covers for busbar connections
Sizes S6 to S12

for mounting onto the contactor enclosure

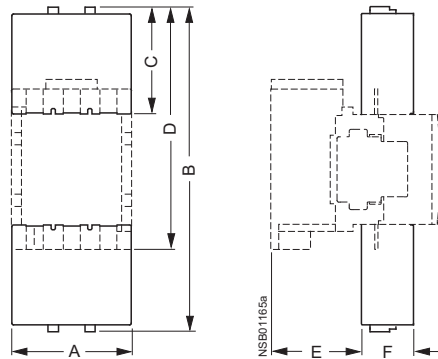

	A	B	C	D	E	F
S6	119	324	107	241	91	52
S10	145	385	128	289	106	66
S12	145	399	128	303	124	66

3RT19 66-1PV4

main current path surge suppression module
for 3RT12 vacuum contactors, sizes S10 and S12

Connected to outgoing side of contactor (2-T1/4-T2/6-T3)
using approx. 350 mm long, molded cable

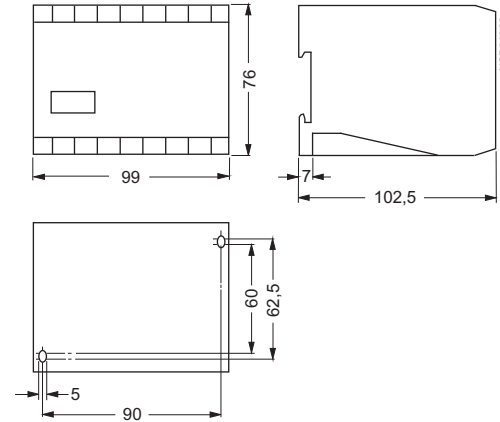

3RT19 .6-4EA2

terminal covers for box terminals
Sizes S6 to S12

for mounting onto box terminals

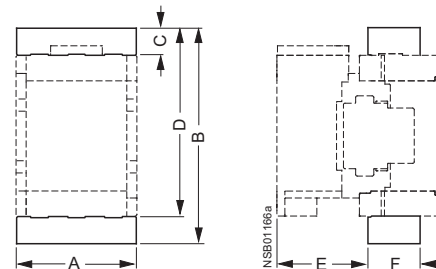

	A	B	C	D	E	F
S6	119	215	27	190	91	52
S10	145	265	30	235	106	66
S12	145	279	30	249	124	66

3RT19 .6-4BA31

links for paralleling
sizes S6 to S12

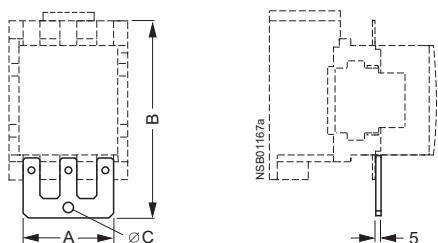

	A	B	∅C
S6	91	199	10.5
S10	121	244	12.5
S12	121	258	12.5

Accessories for 3RA1 contactor assemblies

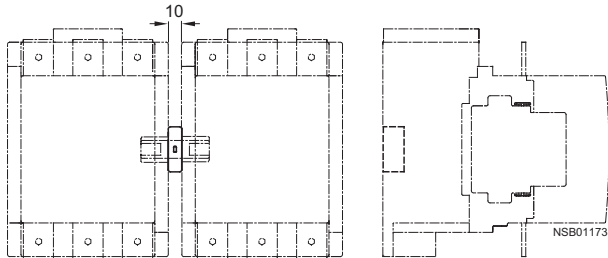
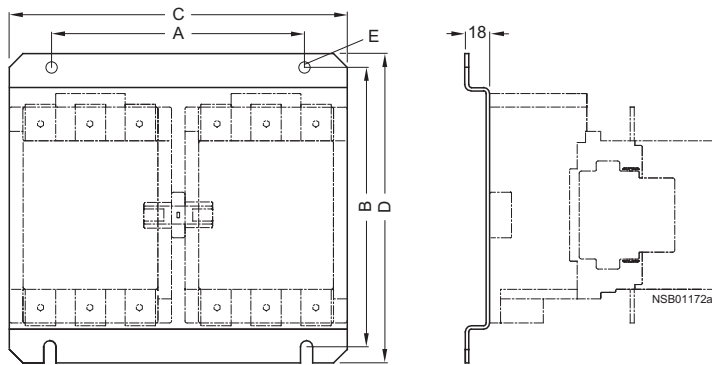
3RA19 54-2A
 mechanical interlocks
 Sizes S6 to S12

3RA19 .2-2A base plates for reversing contactor assemblies

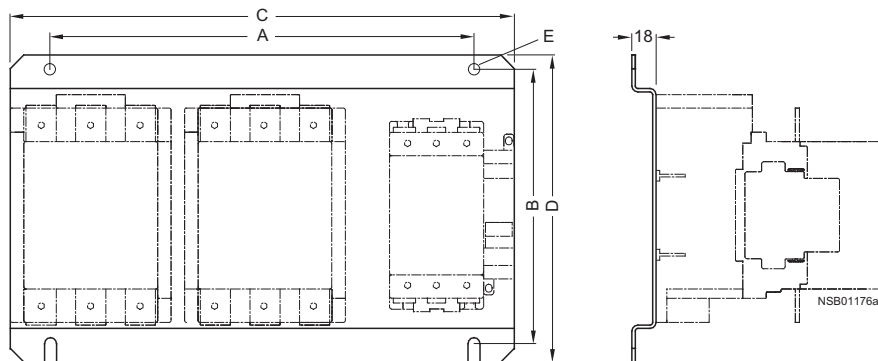
	A	B	C	D	E
S6	190	205	250	229	9
S10	240	249	300	275	11
S12	280	249	330	275	11

3RA19 .2-2E, 3RA19 .2-2F
 base plates for contactor assemblies for wye-delta starting

	A	B	C	D	E
S6-S6-S3	316	205	376	229	9
S6-S6-S6	343	205	403	229	9
S10-S10-S6	393	250	453	275	11
S10-S10-S10	423	250	483	275	11
S12-S12-S10	450	250	510	275	11
S12-S12-S12	465	250	525	275	11

Project planning aids

3RA13 reversing contactor assemblies

Size S00

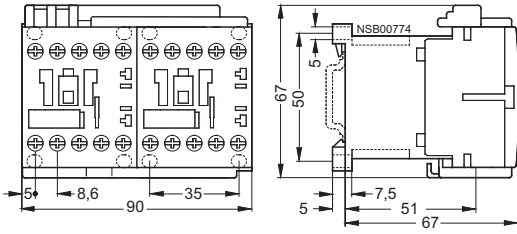

Size S0 with 3RA19 24-2B mechanical interlocking Lateral

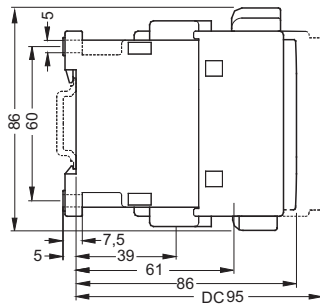
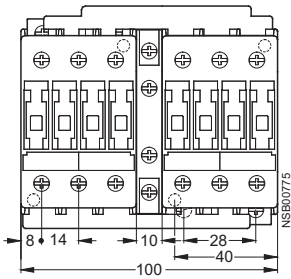

with 3RA19 24-1A mechanical interlocking On front

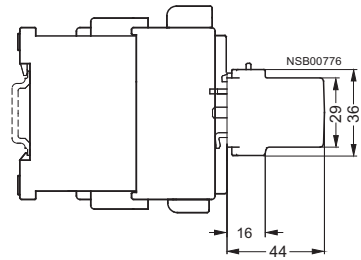
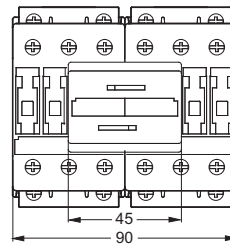

Size S2

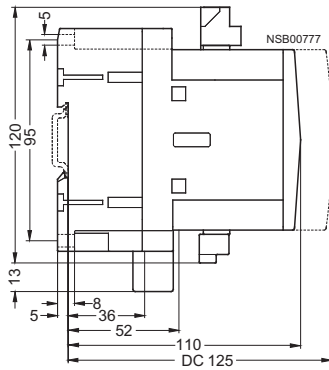
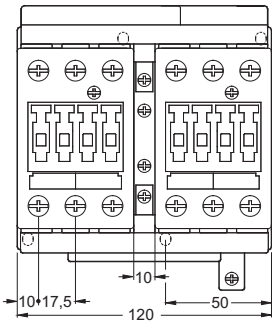

Size S3

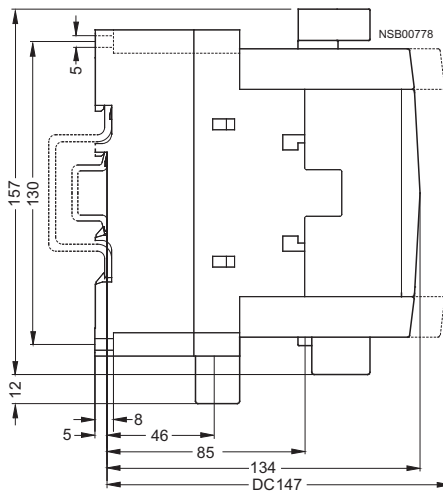
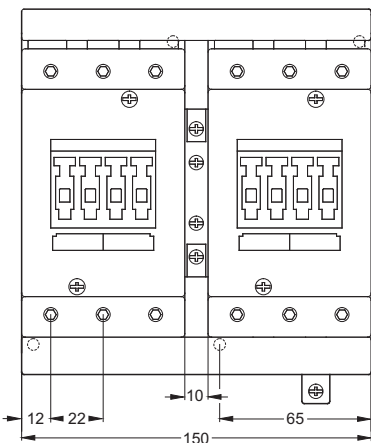

3RA13 reversing contactor assemblies

Size S6 with 3RA19 53-2A wiring module

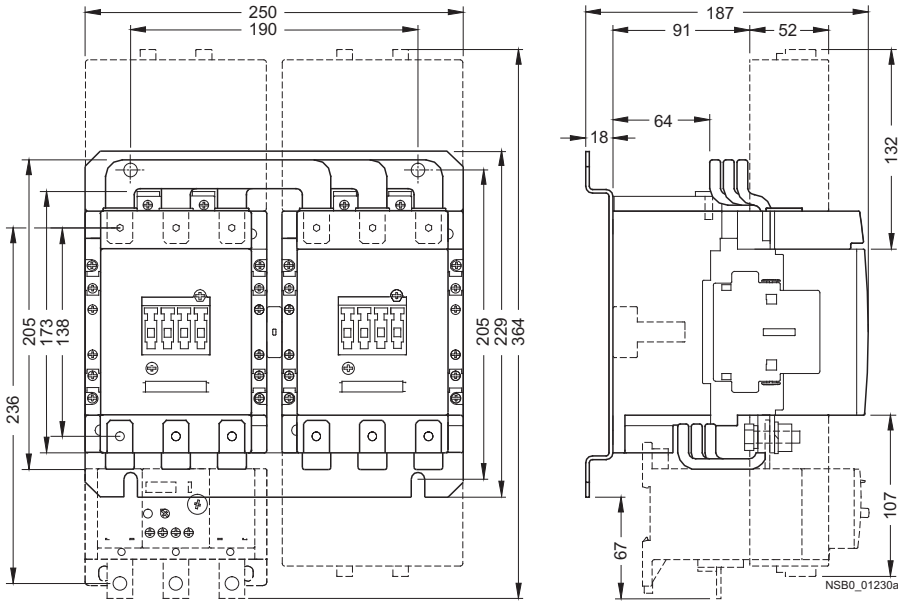

Size S6 with 3RA19 53-2M wiring module

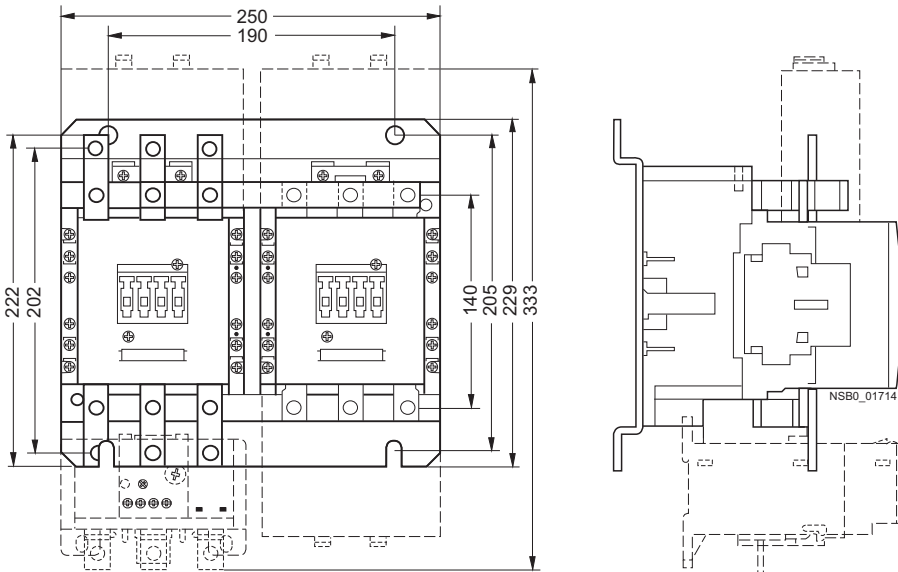

Project planning aids

3RA13 reversing contactor assemblies

Size S10

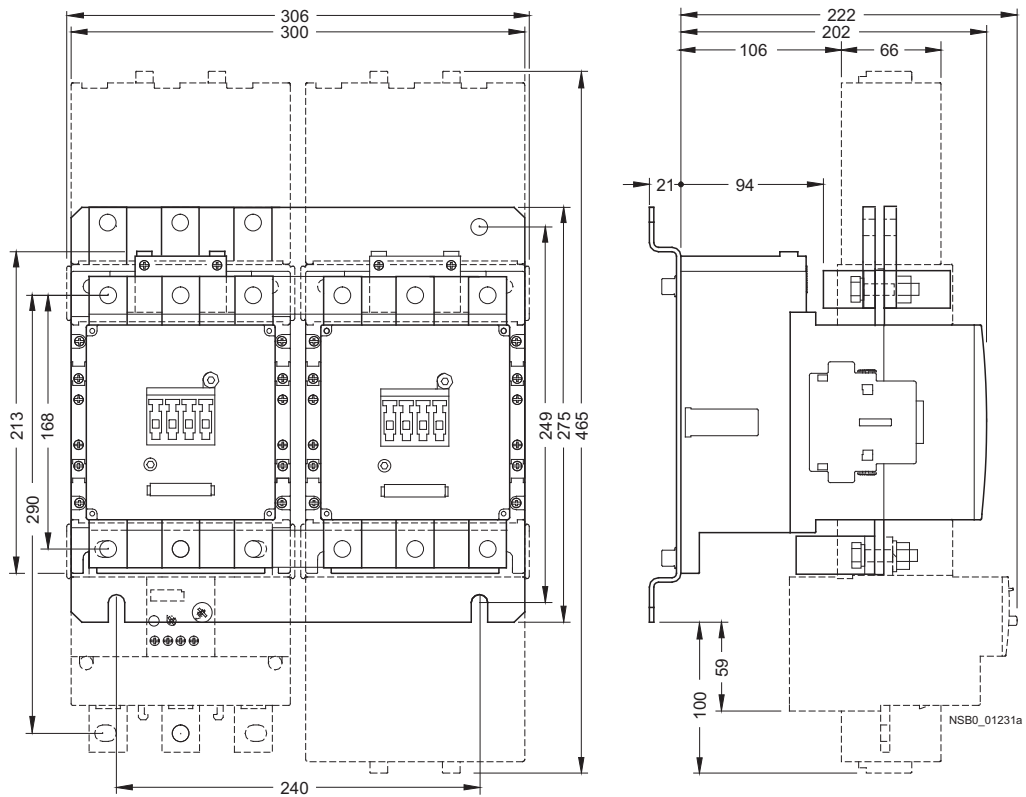

Size S12

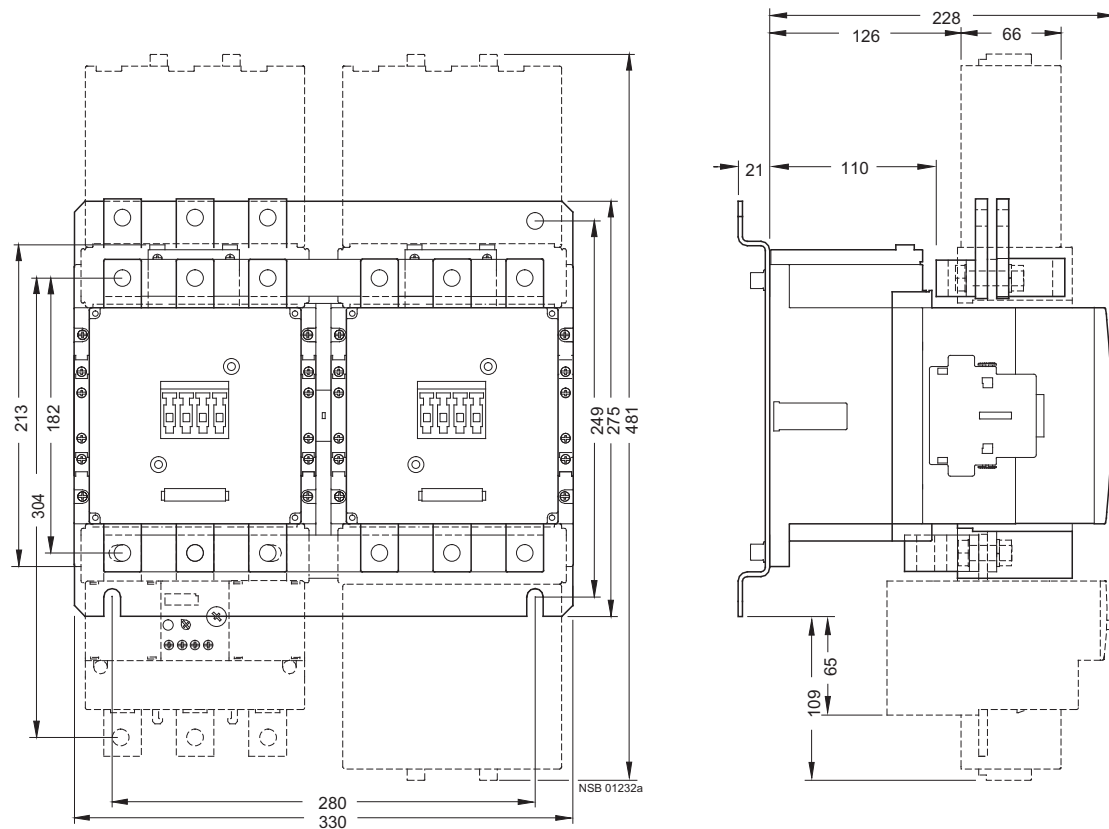

3RA14 contactor assemblies for wye-delta starting

Sizes S00 – S00 – S00

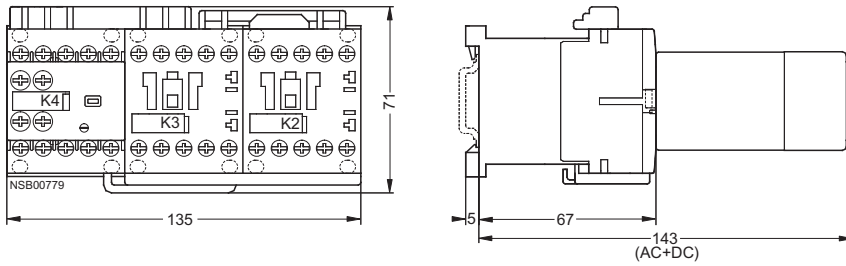

Sizes S0 – S0 – S0

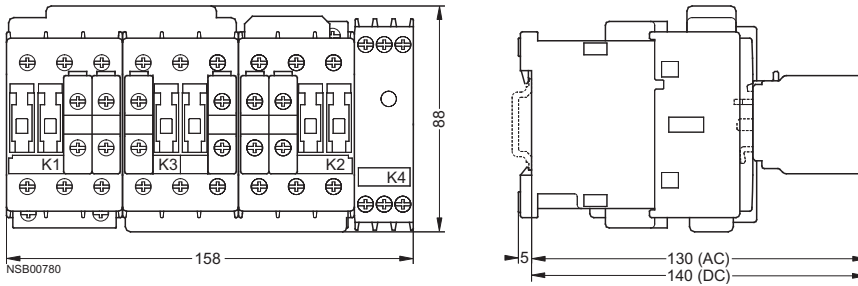

Sizes S2 – S2 – S0

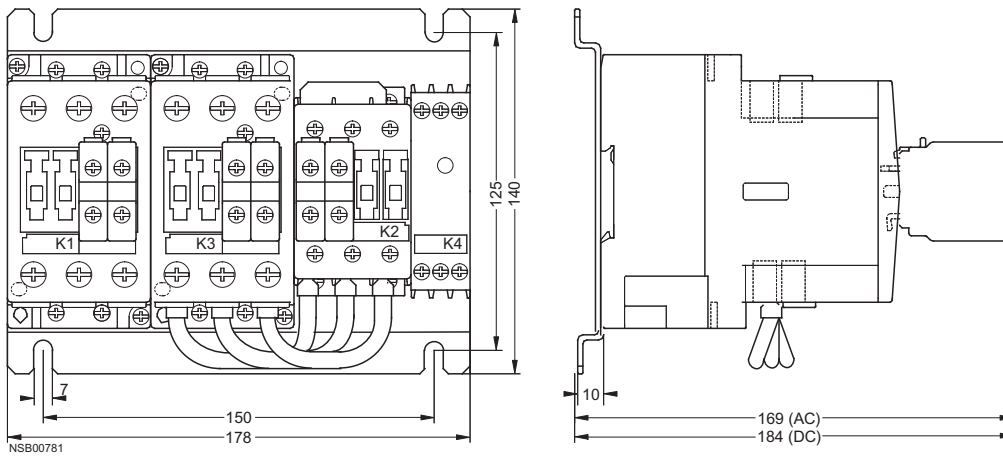

Sizes S2 – S2 – S2

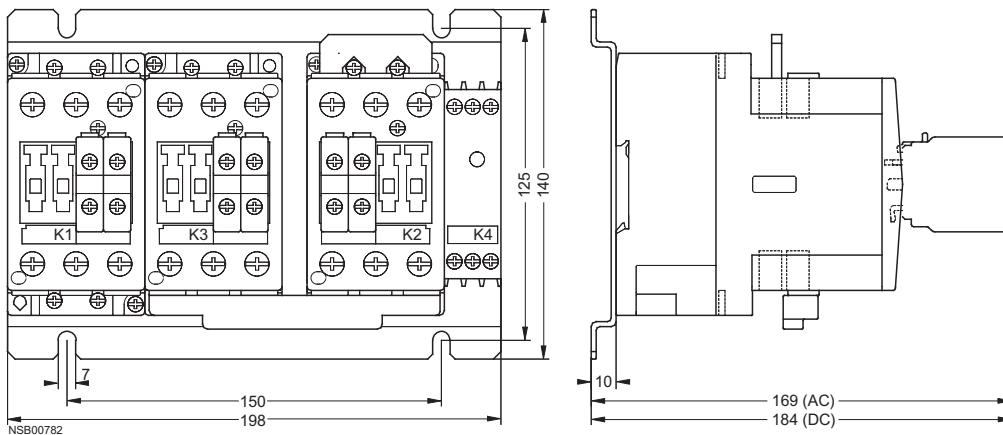

3

Project planning aids

3RA14 contactor assemblies for wye-delta starting

Sizes S3 – S3 – S2

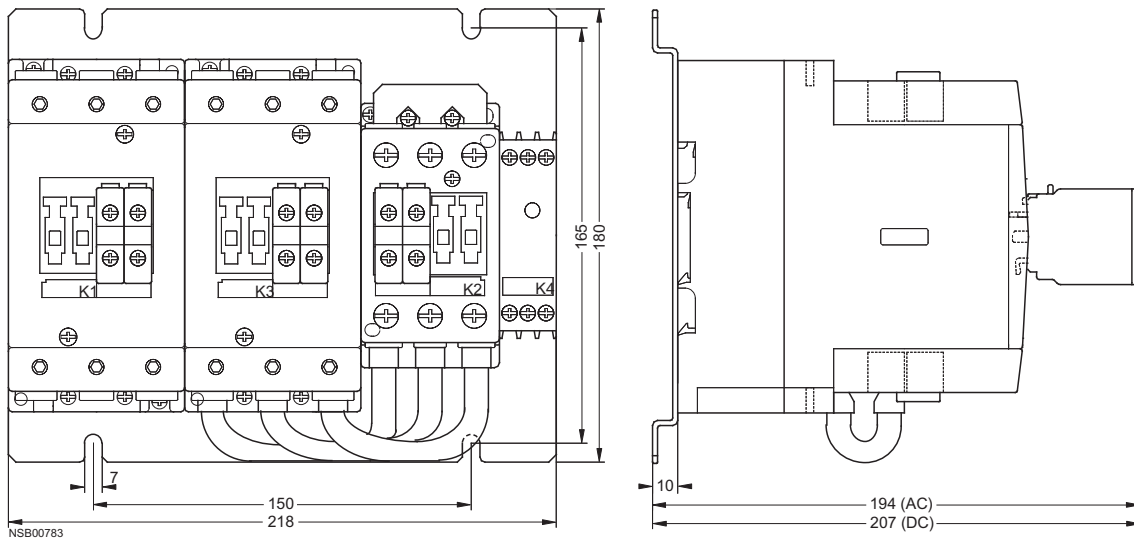

3TG10 miniature contactors

3TG10 ..-0..contactors
with screw terminals

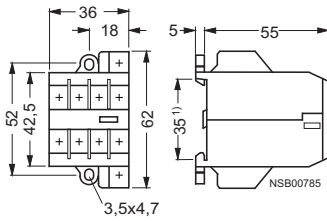

3TG10 ..-1..contactors
with tab connectors

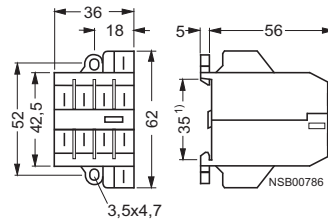

3TG10 contactors
with 3UA7 overload relays

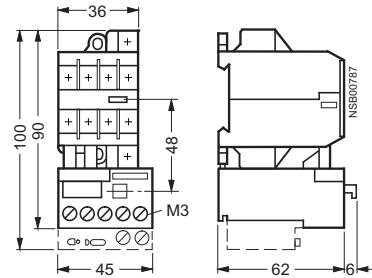

3RT19 16-4BB41 links for paralleling, 4-pole, with terminal
for **3TG10** contactors

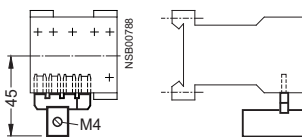

The links for paralleling can be reduced by one pole.

1) Can be snapped onto 35 mm standard mounting rail.

3TF68 and 3TF69 vacuum contactors, 3-pole

3TF68 vacuum contactors

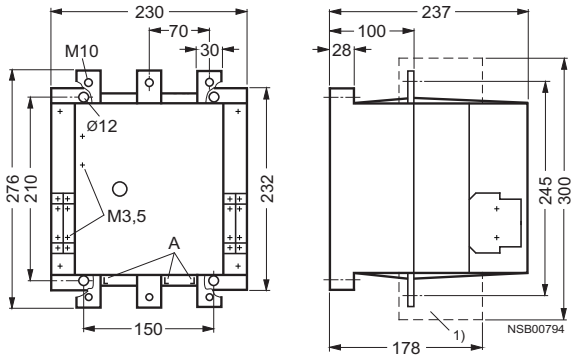

Detail

A = Contact erosion indication for vacuum interrupter contacts

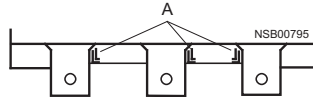

3TF69 vacuum contactors

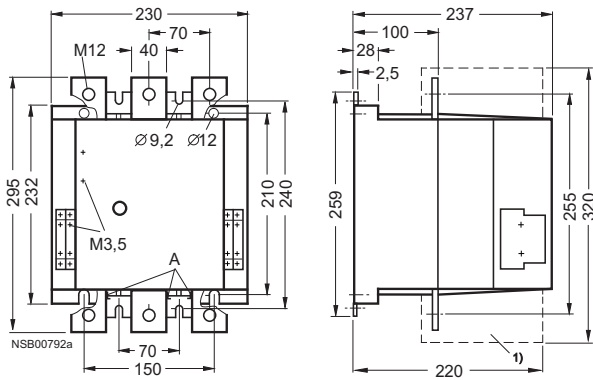

Detail

A = Contact erosion indication for vacuum interrupter contacts

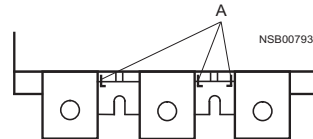

1) With box terminals for laminated copper bars (accessories).

Project planning aids

Accessories for 3T contactors

3TX7 462-3. varistors

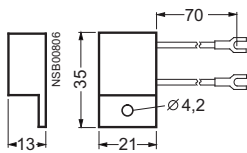

3TX7 462-3., 3TX7 522-3., 3TX7 572-3. RC elements and varistors

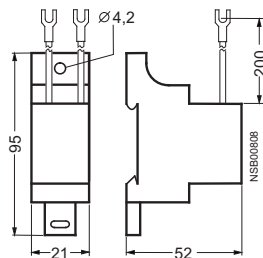

3TX7 090-0D coupling link for laterally snapping onto contactors

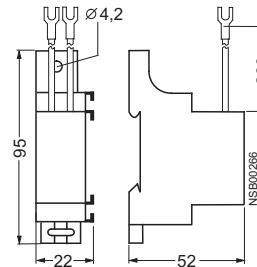

3TX7 box terminals for laminated copper bars

Box terminals with cover, mounted to contactor

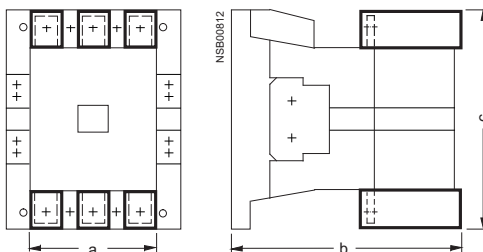

For contactor type	Box terminals	a	b	c
3TF68	3TX7 570-1.	182	178	300
3TF69	3TX7 690-1F	200	219	320

3TX7 686-0A and 3TX7 696-0A terminal covers

For 3TF68 and 3TF69 contactors, size 14,

for screwing onto free screw end of the two outer conducting paths

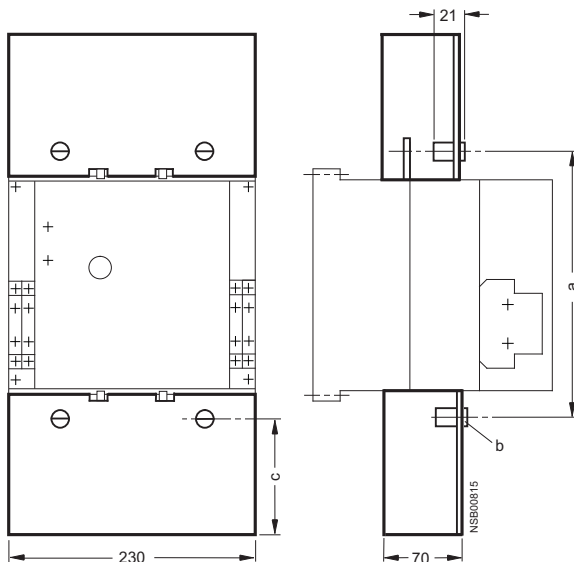

For contactor type	Terminal covers	a	b	c
3TF68	3TX7 686-0A	245	M10	104
3TF69	3TX7 696-0A	255	M12	99

3TX7 680-0D link for paralleling

for 3TF68 contactors

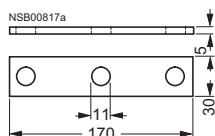

3TX7 680-0E cover plate

for 3TX7 680-0D link for paralleling for 3TF68 contactor

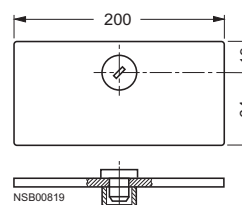

3TB5 contactors

3TB50 and 3TB52 contactors Sizes 6 and 8

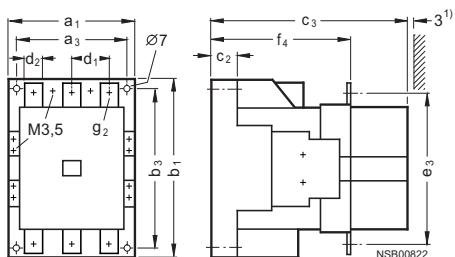

Type	a ₁	a ₃	b ₁	b ₃	c ₂	c ₃	d ₁	d ₂	e ₃	f ₄	g ₂
3TB50	120	100	150	130	23	198	37	15	133	137.5	M6
3TB52	135	110	180	160	28	217	42	20	154	147	M8

¹⁾ Minimum clearance from insulated components 3 mm.
Minimum clearance from grounded components 10 mm.

3TB54 and 3TB56 contactors Sizes 10 and 12

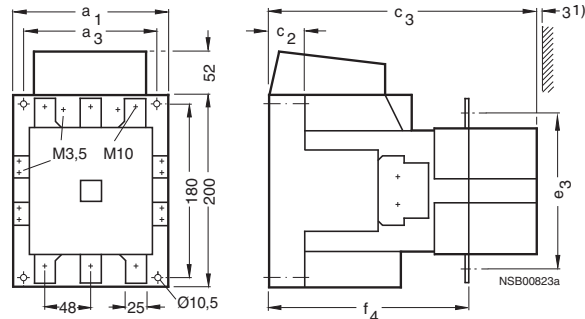

Type	a ₁	a ₃	c ₂	c ₃	e ₃	f ₄
3TB54	145	120	30.5	264	168	188
3TB56	160	130	39	282	178	200

3TX6 .. 6-3B terminal covers

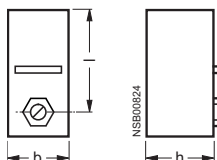

For contactors		Size	Type	b	h	l
		6	3TB50	27	33	58
		8	3TB52	34	44	75
		10 to 12	3TB54 to 3TB56	38	56	95

3TD68, 3TE68 contactor assemblies

3TD68 contactor assemblies

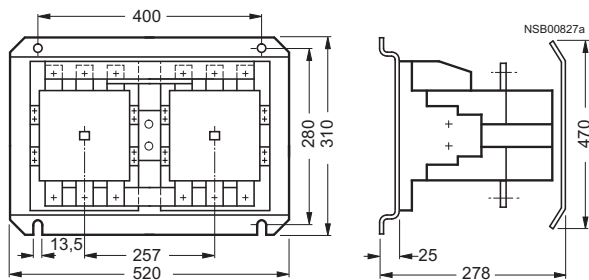

3TE68 contactor assemblies

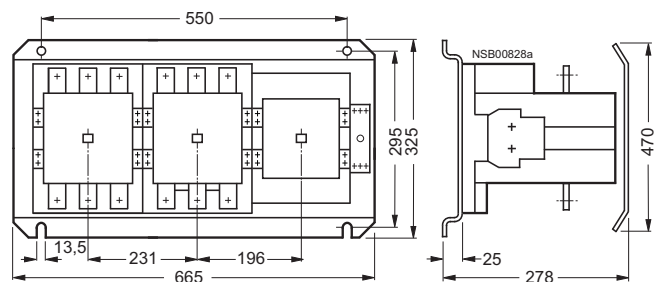

Controls – Contactors and Contactor Assemblies

Project planning aids

3TK10 to 3TK17 contactors

3TK10 to 3TK17 contactors

The scope of supply includes screws and rubber buffers.

⊕ M10 grounding screw for 3TK14 to 3TK17

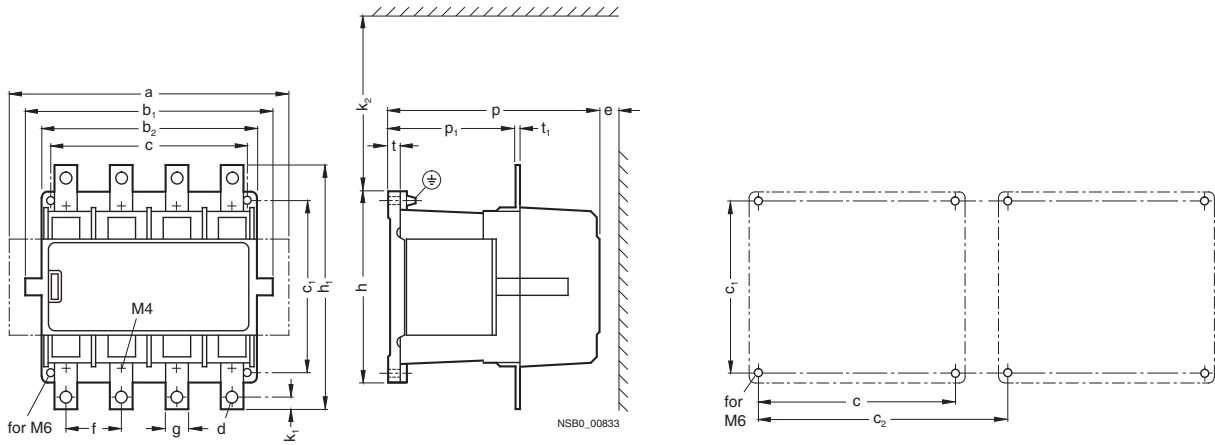

Contactors Type	a	b ₁	b ₂	c	c ₁	c ₂ ¹⁾	c ₂ ²⁾	d ³⁾	e min.	f	g	h	h ₁	k ₁	k ₂ ⁴⁾	p	p ₁	t	t ₁
3TK10	186	165	136	120	140	166	187	6.6	40	41	15	156	156	7.5	134	154.5	102.3	10	4
3TK11	186	165	136	120	140	168	187	11	40	42	20	156	172	10	134	154.5	102.3	10	4
3TK12	225	201	176	160	140	202	226	11	15	45	20	156	198	10	134	172	106.7	10	5
3TK13	225	201	176	160	140	202	226	11	15	45	20	156	198	10	134	172	106.7	10	5
3TK14	266	244	244	220	200	271	293	11	40	67	25	223	272	12.5	--	225.5	139.5	23 ⁵⁾	6
3TK15	266	244	244	220	200	271	293	11	40	67	25	223	273	12.5	--	225.5	139.5	23 ⁵⁾	6
3TK17	266	244	244	220	200	271	293	11	40	67	40	223	273	12.5	--	225.5	139.5	23 ⁵⁾	6

1) Distance when 2 contactors, each with one auxiliary switch block opposite, are mounted.

2) Distance when 2 contactors, each with two auxiliary switch blocks opposite, are mounted.

3) Nuts, bolts, screws and washers are supplied.

4) Minimum clearance for removing the withdrawable coil.

5) Damping elements are supplied.

Accessories for 3TK1 contactors

3TK19 4. terminal covers

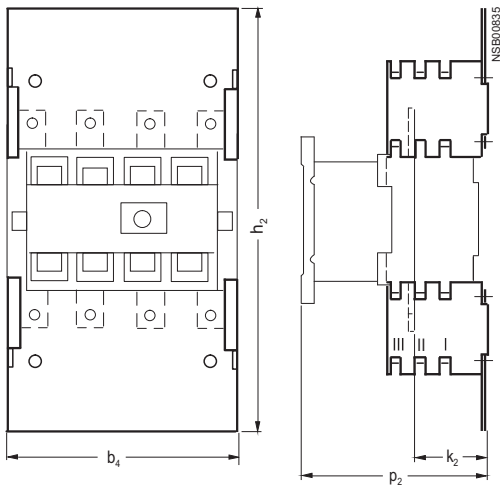

Contactors Type	Terminal covers	h ₂	p ₂ for			k ₂ for			b ₄
			I	II	III	I	II	III	
3TK10, 3TK11	3TK19 40-0A	372	153	178	203	47	72	97	168
3TK12, 3TK13	3TK19 42-0A	399	158	183	208	47	72	97	202
3TK14, 3TK15	3TK19 44-0A	464	193	218	243	47	72	97	268
3TK17	3TK19 46-0A	464	193	218	243	47	72	97	268

3TK19 20 and 3TK19 22 locking devices

for mechanical locking of two identical 3TK10 to 3TK13 contactors, mounted side by side on the mounting plate

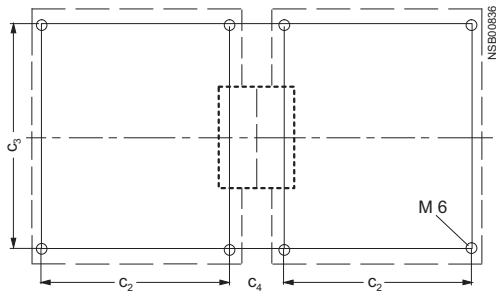

Contactors Type	Locking devices	c ₂	c ₃	c ₄
3TK10, 3TK11	3TK19 20-0A	120	140	65
3TK12, 3TK13	3TK19 22-0A	160	140	63.5

3TK19 24 locking device

for mechanical locking of two identical 3TK14, 3TK15 or 3TK17 contactors, mounted side by side on the mounting plate

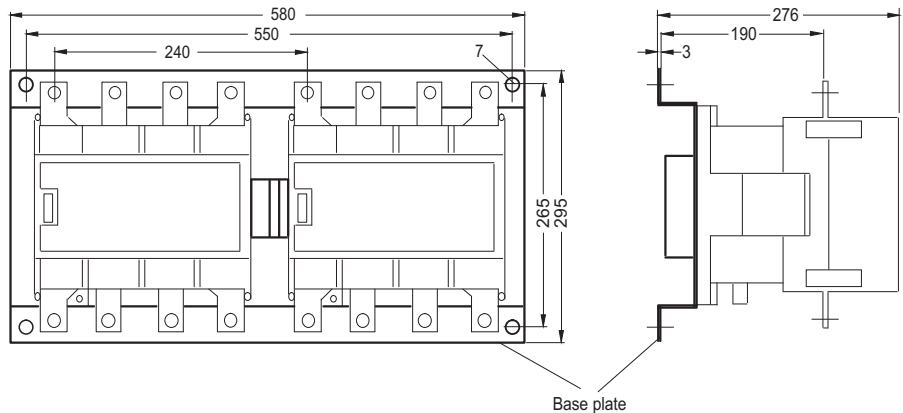

Project planning aids

3TC4 and TC5 contactors

3TC44 contactors Size 2, AC and DC operation

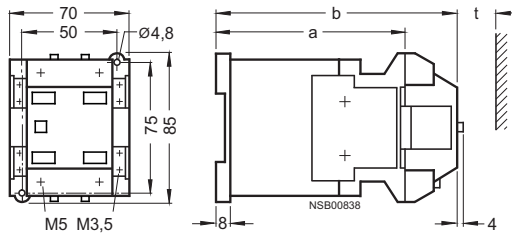

t = minimum clearance from insulated components: 15 mm (600 V and 750 V)
from grounded components: 30 mm (600 V and 750 V)

	a	b
DC operation	109	141
AC operation	68	100

3TC48 contactors Size 4, AC and DC operation

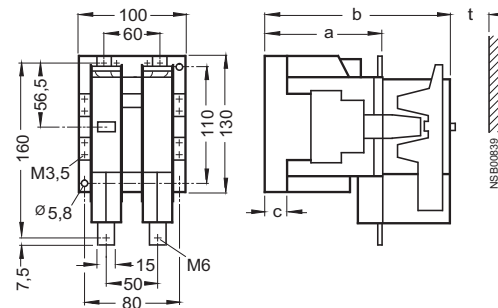

t = minimum clearance from insulated components: 15 mm (600 V),
20 mm (750 V)
from grounded components: 35 mm (600 V),
55 mm (750 V)

	a	b	c
DC operation	112	180	21,5
AC operation	86	154	23,5

3TC52 contactors Size 8, AC and DC operation

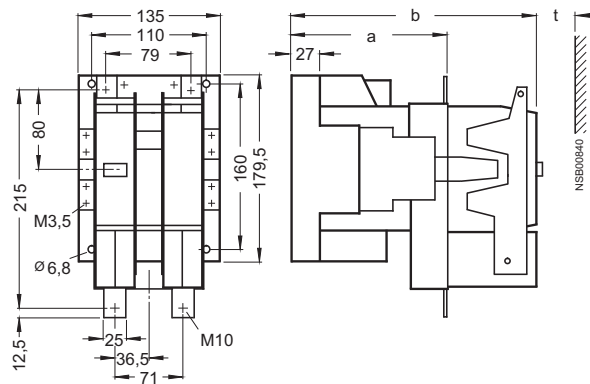

t = minimum clearance from insulated components: 20 mm (600 V and 750 V)
from grounded components: 70 mm (600 V and 750 V)

	a	b
DC operation	147	232
AC operation	115	200

3TC56 contactors Size 12, AC and DC operation

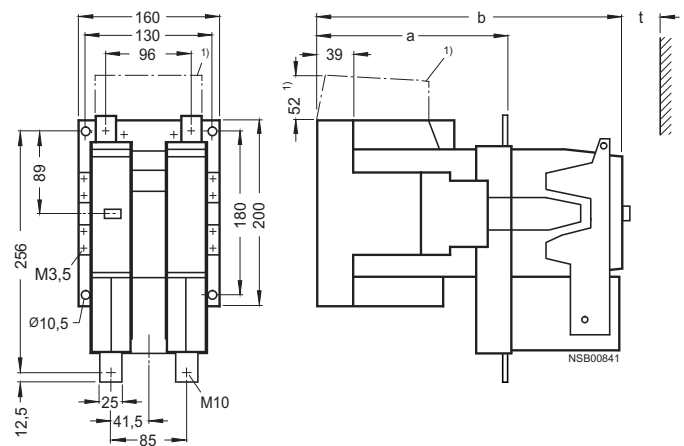

t = minimum clearance from insulated components: 25 mm (600 V and 750 V)
from grounded components: 80 mm (600 V),
100 mm (750 V)

	a	b
DC operation	200	310
AC operation	141	251

1) DC operation only.

3TC7 contactors

3TC74 contactors Size 12, DC and AC operation

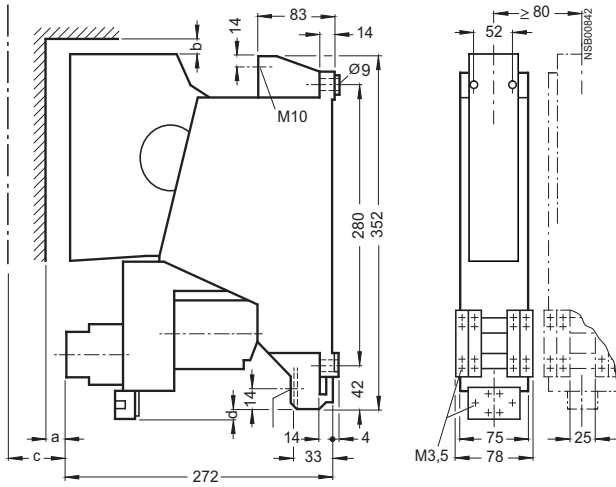

Dimensions	Minimum clearance from insulated components	Minimum clearance from grounded components
a	≥ 20	≥ 50
b	≥ 10	≥ 25
c	≥ 180 (clearance for removing arc chute)	

3TC78 contactors Size 12, DC and AC operation

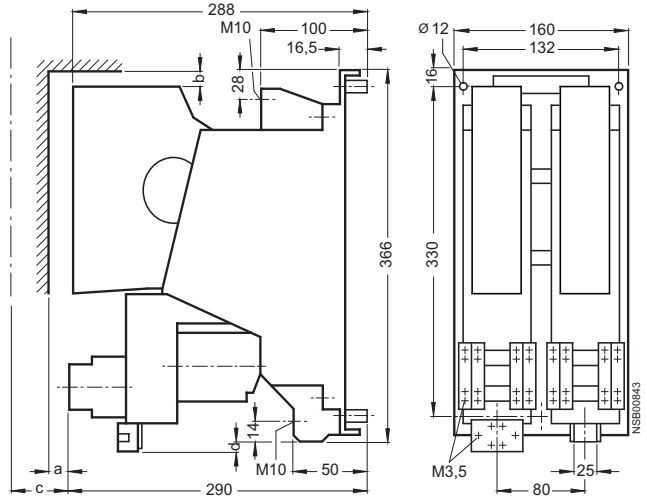

Dimensions	Minimum clearance from insulated components	Minimum clearance from grounded components
a	≥ 20	≥ 50
b	≥ 10	≥ 25
c	≥ 180 (clearance for removing arc chute)	
d	Coil terminal 3TC78 14-0E: 8 mm 3TC78 14-1C: 16 mm	

3TX2 746-2. varistors for 3TC74 and 3TC78 contactors

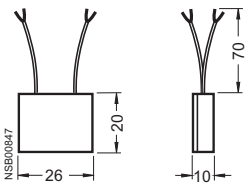

Project planning aids

Contactors with extended operating range 0.7 to 1.25 x U_s

3TC44 17-0L contactors, size 2, DC operation

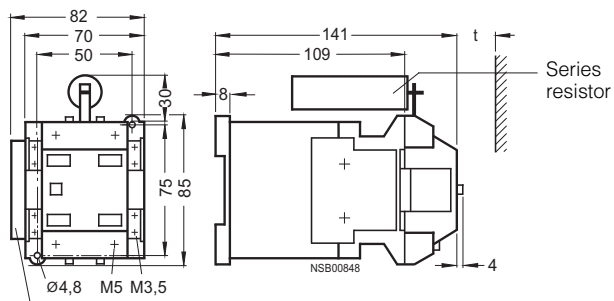

Varistor

t = minimum clearance from insulated components: 15 mm (600 V and 750 V)
from grounded components: 30 mm (600 V and 750 V)

Additional space requirements for mounting resistors and varistors

For 3TB50 to 3TB56, 3TC48 to 3TC56 contactors

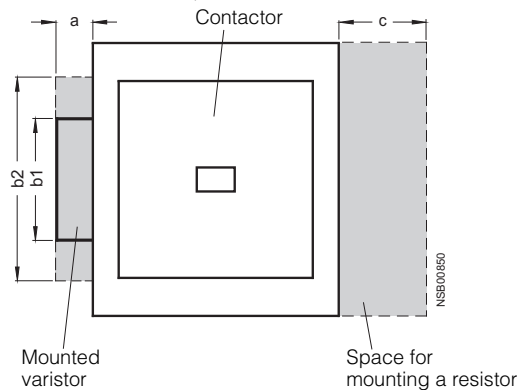

Separately mounted series resistor

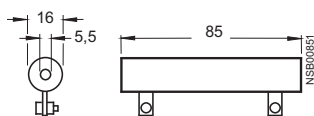

For contactors	Additional space requirements			
	for series resistor c	for varistor a	b ₁	b ₂ *)
3TB50	30	13	70	110
3TB52, 3TB54, 3TB56	--	15	82	120
3TC48	30	13	70	110
3TC52, 3TC56	--	15	82	120

*) Terminal compartment.

For contactors	Number of series resistors
3TB52, 3TC52	1
3TB54, 3TB56	2
3TC56	2

3TF2 contactors for switching motors, width 45 mm, size S00

3TF20, 3TF28,

with 1 auxiliary contact, with screw terminals, AC and DC operation, without or with overload relay (3UA7),

- ① 3TX4 490 surge suppressor
- ② Additional module (on overload relay)

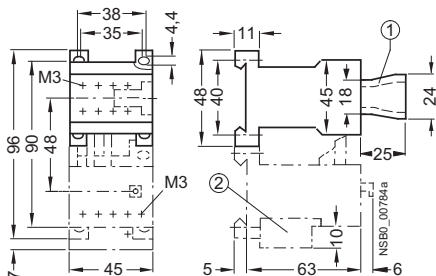

3TF20, 3TF22, 3TF28, 3TF29

with 2 to 5 auxiliary contacts, with screw terminals, AC and DC operation, without or with overload relay

- ① 3TX4 490 surge suppressor
- ② Additional module (on overload relay)
- ③ Auxiliary switch block

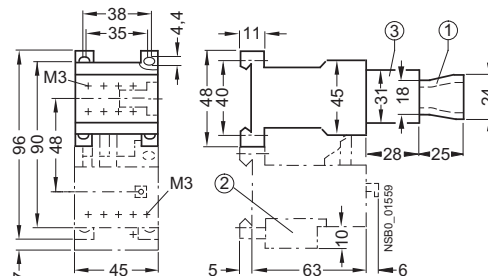

3TF20

with flat connectors 6.3 mm x 0.8 mm, for snap-on and screw fixing, AC and DC operation

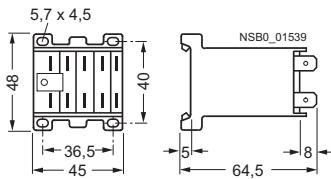

3TF20

with flat connectors 6.3 mm x 0.8 mm, for screw fixing (diagonal), AC and DC operation

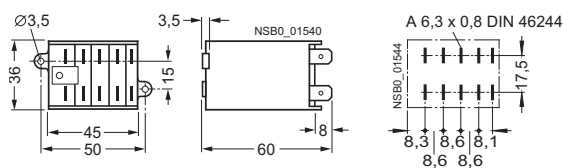

Grid size for flat connectors

3TF20

with solder pin connections for printed circuit boards for screw fixing (diagonal), AC and DC operation

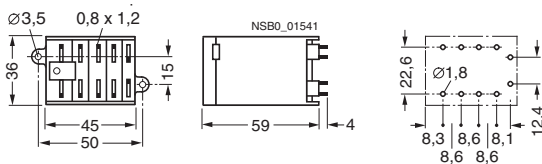

Hole pattern for solder pin connections

3TX4 491-2A plug-in base

with solder pin connections for printed circuit boards

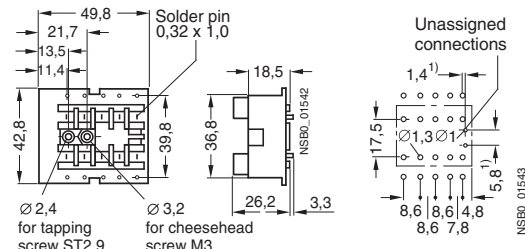

Hole pattern for plug-in base

3TX4 490 OFF-delay device

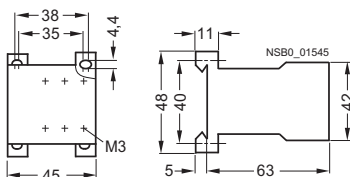

1) Holes required only for integrated overvoltage damping in the plug-in base.

Controls – Contactors and Contactor Assemblies

Project planning aids

3TK20 contactors, width 45 mm, size S00

3TK20

with screw terminals, for snap-on and screw fixing, AC and DC operation

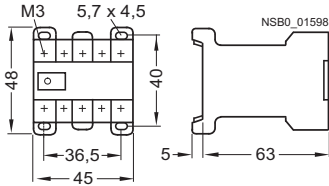

3TK20

with flat connectors 6.3 mm x 0.8 mm, for snap-on and screw fixing, AC and DC operation

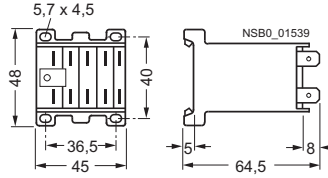

3TK20

with flat connectors 6.3 mm x 0.8 mm, for screw fixing (diagonal), AC and DC operation

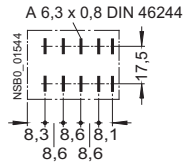
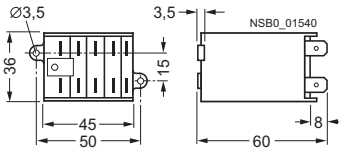

Grid size for flat connectors

3TK20

with solder pin connections for printed circuit boards, for screw fixing (diagonal), AC and DC operation

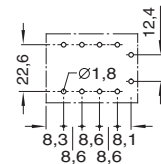
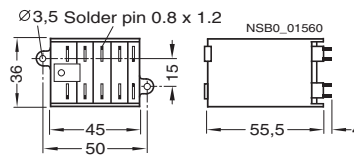

Hole pattern for solder pin connections

3TX4 491-2A plug-in base

with solder pin connections for printed circuit boards

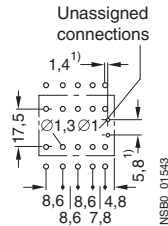
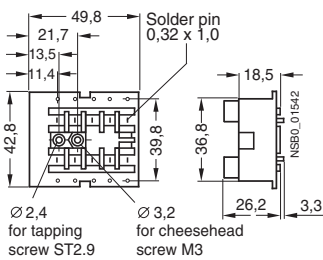

Hole pattern for plug-in base

1) Holes required only for integrated overvoltage damping in the plug-in base.

3TH2 contactor relays, width 45 mm, size S00

3TH20 with 4 contacts
with screw terminals,
AC and DC operation

- ① 3TX4 490 surge suppressor

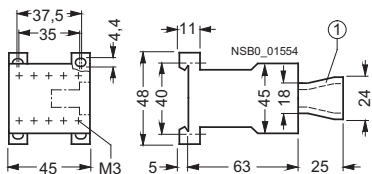

3TH20 with 4 contacts
AC and DC operation

- ① 3TX4 490 surge suppressor

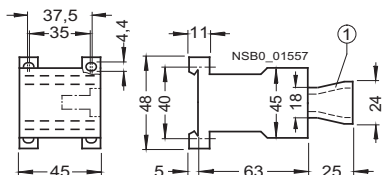

3TH20 with 6 and 8 contacts,
3TH22 with 8 contacts
with screw terminals,
AC and DC operation

- ① 3TX4 490 surge suppressor
- ② Auxiliary switch block

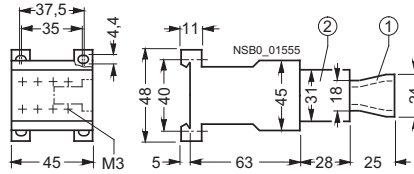

3TH20 with 6 and 8 contacts,
3TH22 with 8 contacts
AC and DC operation

- ① 3TX4 490 surge suppressor
- ② Auxiliary switch block

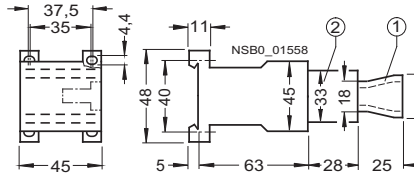

3TH20

with flat connectors 6.3 mm x 0.8 mm,
for snap-on and screw fixing,
AC and DC operation

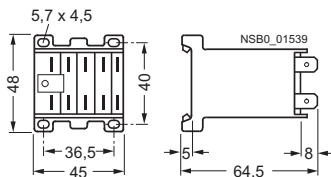

3TH20

with solder pin connections for printed circuit boards
for screw fixing (diagonal),
AC and DC operation

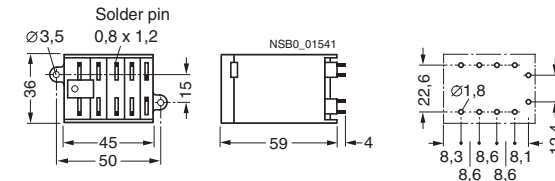

Hole pattern
for solder pin
connections

3TX4 491-2A plug-in base

with solder pin connections for printed circuit boards

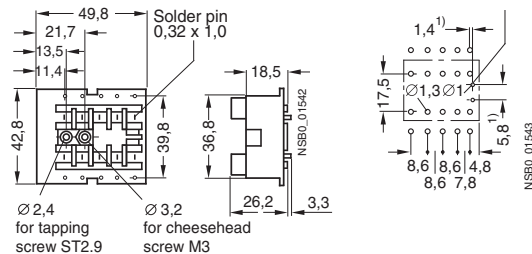

Hole pattern for
plug-in base

3TX4 490 OFF-delay device

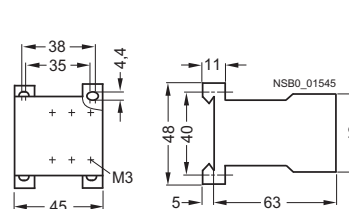

1) Holes required only for integrated overvoltage damping in the plug-in base.

Controls – Contactors and Contactor Assemblies

Project planning aids

3TH27 latched contactor relays, width 90 mm, size S00

3TH27 with 4 contacts
with screw terminals,
for screw and snap-on mounting,
AC and DC operation

① 3TX4 490
surge suppressor

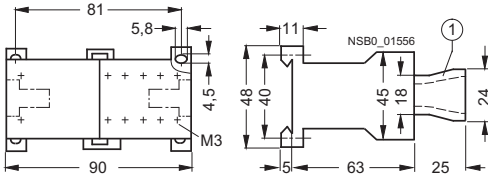

Coupling relays in industrial enclosure

3RS18

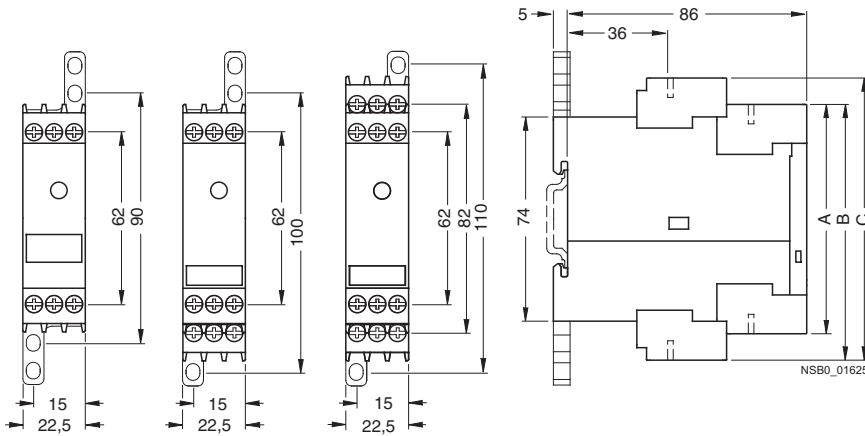

	A	B	C
	3RS18 00-.A	3RS18 00-.B	3RS18 00-.H
Removable terminals			
Spring-type terminals	84	94	103
Screw terminals	83	92	102

Coupling relays with narrow design

3TX7 002, 3TX7 003 coupling links in terminal block design

**3TX7 00 .-1AB . . . ,
3TX7 00 .-2A . . . ,
3TX7 002-3AB01**

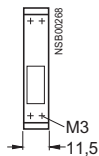

**3TX7 002-3AB00,
3TX7 002-4A . . .**

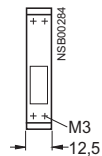

**3TX7 00 .-1BB00,
3TX7 00 .-1BF00,
3TX7 002-2BF02**

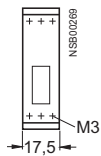

**3TX7 00 .-1CB00,
3TX7 002-1FB02**

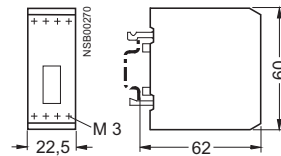

3TX7 004, 3TX7 005 coupling links in double-decker design

**3TX7 00 .-1MB00,
3TX7 00 .-1MF00,
3TX7 00 .-1L . 0 . . ,
3TX7 00 .-2M . . .
relay coupling links**

**3TX7 00 .-1AB10,
3TX7 00 .-1BB00,
3TX7 00 .-1BB10,
3TX7 00 .-1CB00,
3TX7 00 .-1BF05
relay coupling links**

**3TX7 00 .-3AB04,
3TX7 00 .-4AB04,
3TX7 00 .-3PB . . ,
3TX7 00 .-3PG74,
3TX7 00 .-3RB43
semiconductor coupling links**

**3TX7 00 .-3AC04,
3TX7 00 .-3AC14,
3TX7 00 .-3AC03
semiconductor coupling links**

**3TX7 00 .-1HB00
relay coupling links**

**3TX7 00 .-1GB00
relay coupling links**

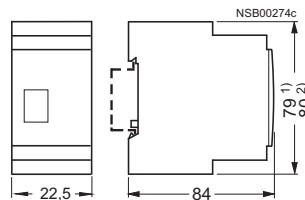
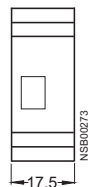
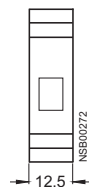
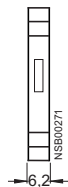

**3TX7 014, 3TX7 015
relay couplers with plug-in design**

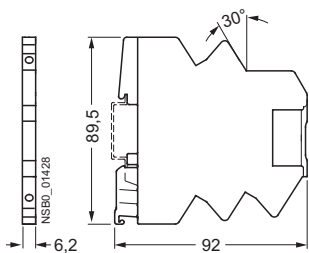

**3TX7 014-7CE00
galvanic isolation plate**

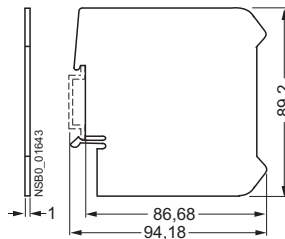

**3TX7 014-7AA00
connecting comb, 16-pole**

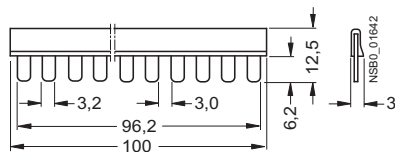

**3TX7 014-7B.0.
individual relay module**

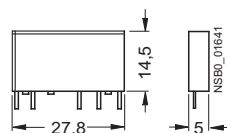

- 1) Dimensions for 3TX7 004 coupling links (screw terminals).
- 2) Dimensions for 3TX7 005 coupling links (spring-type terminals).

Project planning aids

LZS:PT relay couplers

Complete units, 11- and 14-pole, PT series

LZS:PT3A5

LZS:PT5A5

Standard plug-in base with screw terminals

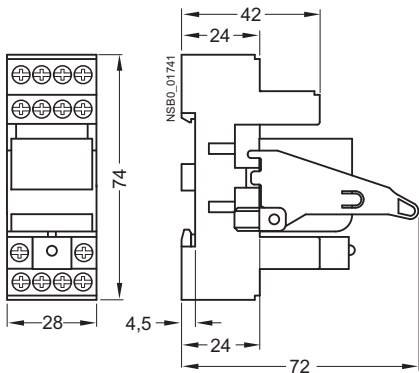

LZS:PT5B5

Plug-in base with logical isolation and screw terminals

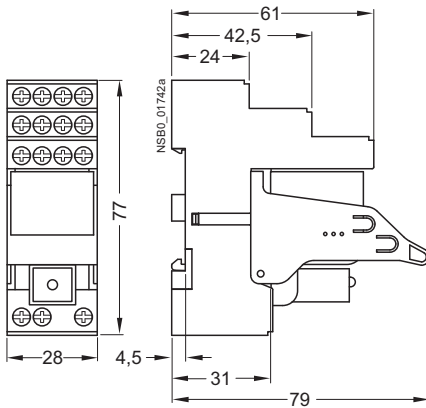

LZS:PT5D5

Plug-in base with logical isolation and plug-in terminals

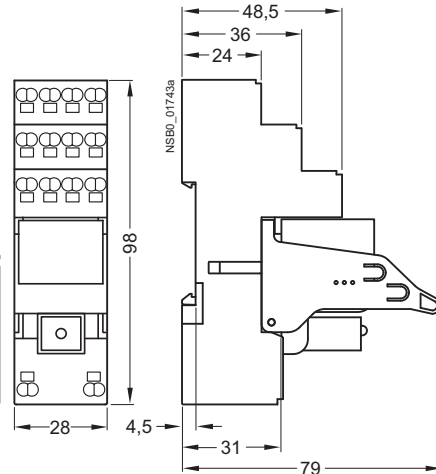

LZX industrial relays, 8-, 11-, and 14-pole, PT series

LZX:PT270, 8-pole

2 CO

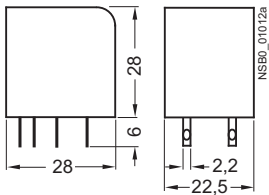

LZX:PT370, 11-pole

3 CO

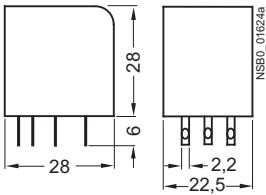

LZX:PT520, LZX:PT570, LZX:PT580, 14-pole

4 CO

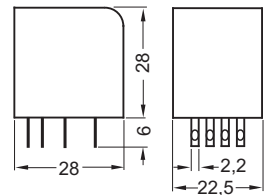

Plug-in bases for PT series

LZS:PT78740

with screw terminals

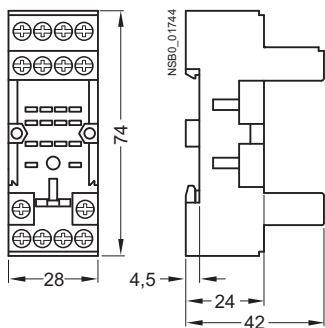

LZS:PT78742

with logical isolation and screw terminals

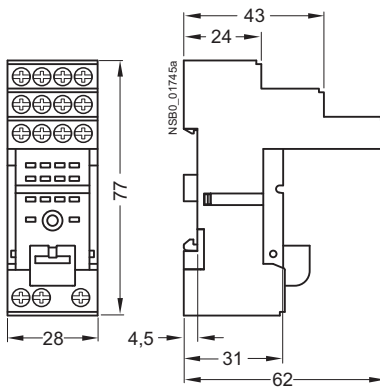

LZS:PT7874P

with logical isolation and plug-in terminals

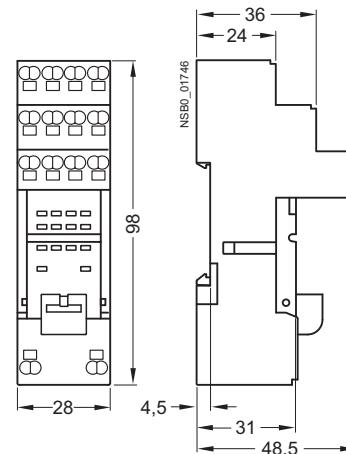

LZS:RT relay couplers

Complete units, 8-pole, 5 mm pinning, RT series

**LZS:RT3A4;
LZS:RT4A4**

Standard plug-in base with screw terminals

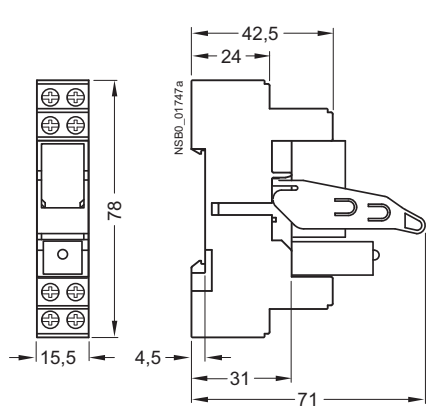

**LZS:RT3B4;
LZS:RT4B4**

Plug-in base with logical isolation and screw terminals

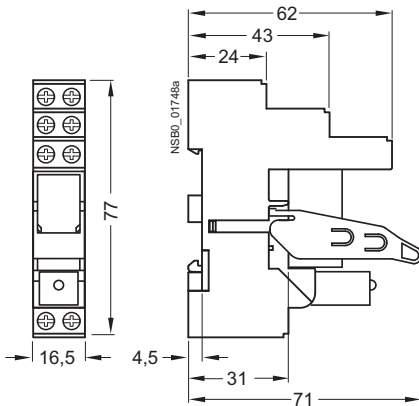

**LZS:RT3D4;
LZS:RT4D4**

Plug-in base with logical isolation and plug-in terminals

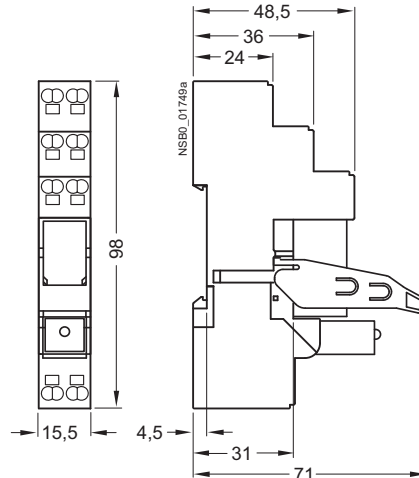

LZX:RT3; LZX:RT4 print relays

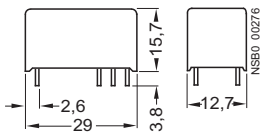

Plug-in bases for RT series

LZS:RT78725

with screw terminals

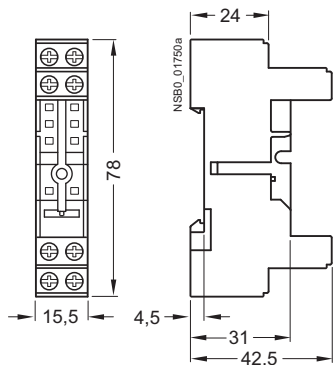

LZS:RT78726

with logical isolation and screw terminals

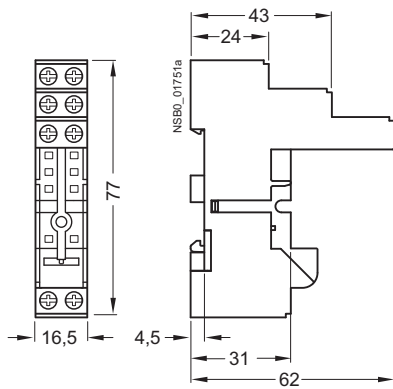

LZS:RT7872P

with logical isolation and plug-in terminals

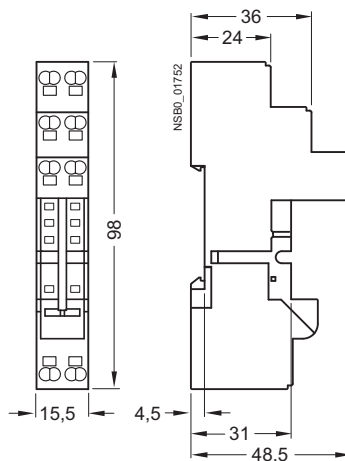

Controls – Contactors and Contactor Assemblies

Project planning aids

LZX:MT relay couplers

Industrial relays, 11-pole, MT series

LZX:MT32

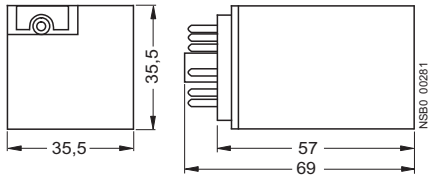

LZS:MT78750 plug-in bases
for industrial relays

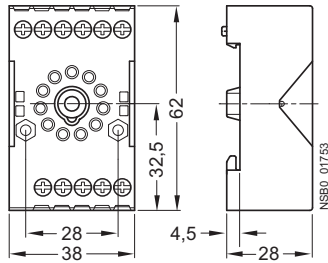

3

Schematics

Internal circuit diagrams for 3RT1 contactors and accessories (valid for screw and Cage Clamp terminals)

Size S00

Terminal designations according to EN 50012

3RT10 1 contactors

1 NO

Ident. No.: 10E

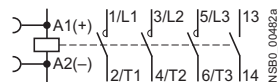

1 NC

01

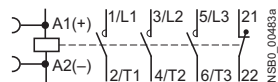

3RT10 1 contactors (with 1 NO)

with front-mounted 3RH19 11-.H... auxiliary switch blocks

1 NO + 1 NC

Ident. No.: 11E

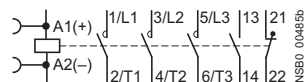

2 NO + 2 NC

22E

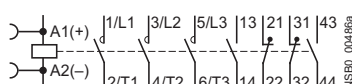

2 NO + 3 NC

Ident. No.: 23E

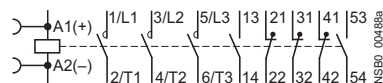

3 NO + 2 NC

32E

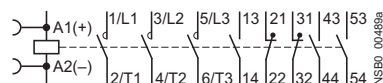

Size S0 to S3

Terminal designations according to EN 50012

3RT10 . . . X . 40-OLA2 contactors

Varistor built-in

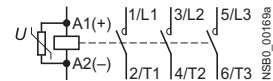

Contactors with 4 main contacts, size S00

Terminal designations according to EN 50005

3RT13 and 3RT15 contactors

4 NO

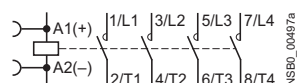

2 NO + 2 NC

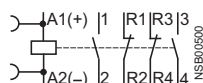

(3RH19 11 auxiliary switch blocks acc. to EN 50005 can be snapped on)

Size S0 to S12

Terminal designations according to EN 50012

3RT10 2, 3RT10 3 contactors

3RT10 5 to 3RT10 7, 3RT12, 3RT14 contactors

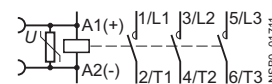
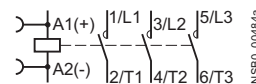

3RT10 2 and 3RT10 3, 3RT14 contactors

with front-mounted 4-pole 3RH19 21-.HA22 auxiliary switch block

2 NO + 2 NC

Ident. No.: 22E

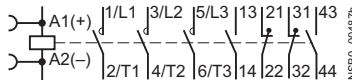

Contactors 3RT1. 5, 3RT1. 6, 3RT1. 7 (sizes S6, S10, S12) with front-mounted 4-pole 3RH19 21-.HA22 auxiliary switch block or with lateral 2-pole 3RH19 21-1DA11 auxiliary switch blocks

2 NO + 2 NC

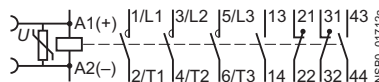

4-pole 3RH19 21-.HA. ./- .XA. . auxiliary switch blocks, for snapping onto the front¹⁾

3 NO + 1 NC

Ident. No.: 31

3RH19 21-.HA..

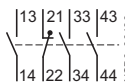

2 NO + 2 NC

Ident. No.: 22

3RH19 21-.HA..

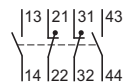

2 NO + 2 NC

Ident. No.: 13

3RH19 21-.XA..

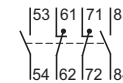

1 NO + 3 NC

Ident. No.: 13

3RH19 21-.HA..

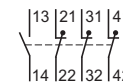

First laterally mountable 3RH19 21-.DA11, 3RH19 21-2DE11 auxiliary switch block (solid-state compatible)

1 NO + 1 NC

Left

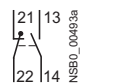

1 NO + 1 NC

Right

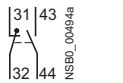

Second laterally mountable 3RH19 21-.JA11, 3RH19 21-2JE11 auxiliary switch block (solid-state compatible) (only for sizes S3 to S12)

1 NO + 1 NC

Left

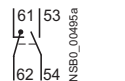

1 NO + 1 NC

Right

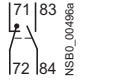

Contactors with 4 main contacts, sizes S0 to S3

Terminal designations according to EN 50005

3RT13 and 3RT15 contactors

4 NO

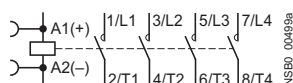

2 NO + 2 NC

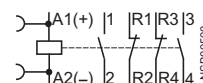

(3RH19 21 auxiliary switch blocks acc. to EN 50005 can be snapped on)

Surge suppressors for sizes S00 to S3 (coded plug-in direction; exception: for 3RT19 16-1T... diode assembly designation with +/-)

Diode



Diode assembly



Varistor



RC element



Diode with LED



Varistor with LED



¹⁾ Not for 3RT12 vacuum contactors.

Project planning aids

Internal circuit diagrams for 3RT1 contactors and accessories (valid for screw and Cage Clamp terminals)

Accessories for size S00 contactors and contactor relays Terminal designations according to EN 50005

3RH19 11-.F... auxiliary switch blocks and 3RH19 11-.NF... solid-state compatible auxiliary switch blocks (solid-state compatible auxiliary switch blocks)

2 NO
Ident. No.: 20

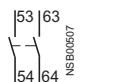

1 NO + 1 NC
11

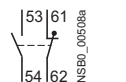

2 NC
02



1 NO + 1 NC
11 U



with make-before-break

4 NO
Ident. No.: 40

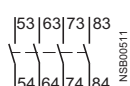

3 NO + 1 NC
31

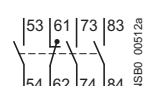

2 NO + 2 NC
22

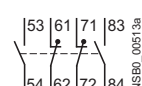

2 NO + 2 NC
22 U

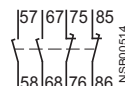

with make-before-break

2 NO + 2 NC
11/11 U

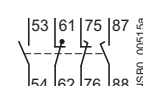

1 NO + 1 NC standard
1 NO + 1 NC with
make-before-break
Internal wiring

3RH19 11-1AA.. and 3RH19 11-1BA..
auxiliary switch blocks,
for snapping onto the front,
cable entry from above or below

1 NO



1 NC



2 NO



1 NO + 1 NC

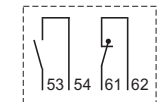

Example of
1 NO + 1 NC, cable
entry from below

Accessories for size S00 contactors and contactor relays Terminal designations according to DIN 46199 Part 5

3RT19 16-2E.../2F.../2G... solid-state, time-delay auxiliary switch blocks

1 NO + 1 NC
With ON-delay

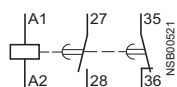

1 NO + 1 NC
OFF-delay

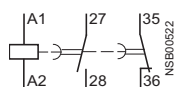

2 NO
Wye-delta function

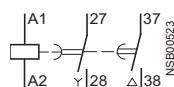

(Integrated varistors not shown)

Accessories for size S0 to S12 contactors Terminal designations according to EN 50005

3RH19 21-.F... auxiliary switch blocks, 4-pole,
for snapping onto the front¹⁾

4 NO
Ident. No.: 40

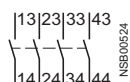

3 NO + 1 NC
31

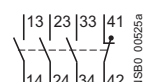

2 NO + 2 NC
22



4 NC
04

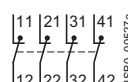

2 NO + 2 NC
22 U

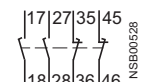

with make-before-break

3RH19 21-.CA... auxiliary switch blocks, 1-pole,
for snapping onto the front¹⁾

1 NO



1 NC



1 NO



1 NC



(Terminal designations according to EN 50005 or EN 50012)

¹⁾ Not for 3RT12 vacuum contactors.

Internal circuit diagrams for 3RT1 contactors and accessories (valid for screw and Cage Clamp terminals)

Accessories for size S0 to S12 contactors
Terminal designations according to EN 50005

3RH19 21-1LA... and 3RH19 21-1MA... auxiliary switch block, 2-pole, for snapping onto the front¹⁾ cable entry from above or below

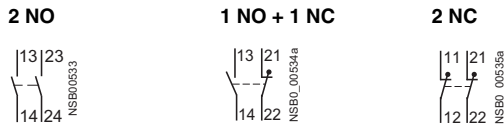

Internal wiring

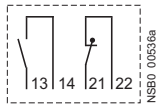

Example of 1 NO + 1 NC, cable entry from below

3RH19 21-.FE22 solid-state compatible auxiliary switch block, 4-pole, for snapping onto the front¹⁾

2 NO + 2 NC
 Ident. No.: 22

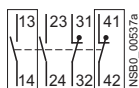

3RH19 21-.EA... first laterally mountable auxiliary switch blocks (left)

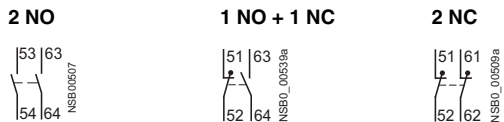

3RH19 21-.EA... first laterally mountable auxiliary switch blocks (right)

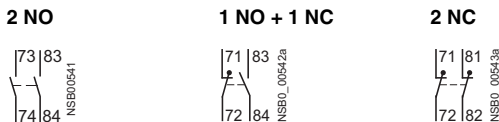

3RH19 21-.KA... second laterally mountable auxiliary switch blocks (left) (only for sizes S3 to S12)

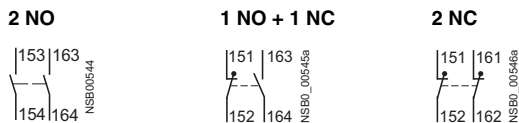

3RH19 21-.KA... second laterally mountable auxiliary switch blocks (right)

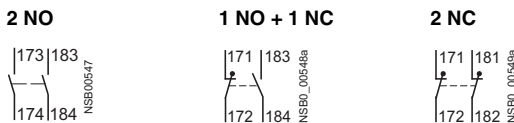

Accessories for size S0 to S12 contactors
Terminal designations according to DIN 46199 Part 5

3RT19 26-2E.../2F.../2G... solid-state, time-delay auxiliary switch blocks

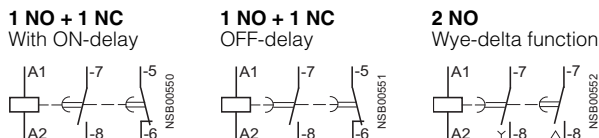

3RH19 24-1GP11 coupling link with surge suppression

Connection diagram

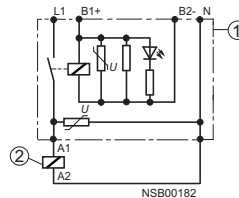

① Coupling link
 ② Contactor

Connection example

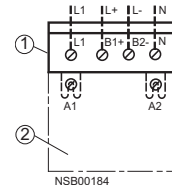

① Coupling link
 ② Contactor

Accessories for contactors size S0
Terminal designations, pneumatic delay block

With ON-delay OFF-delay
 3RT19 26-2PA.1 3RT19 26-2PR.1



¹⁾ Not for 3RT12 vacuum contactors.

Controls – Contactors and Contactor Assemblies

Project planning aids

Schematics for accessories for sizes S00 to S3

3RT19 16-2BK01, 110 V UC
3RT19 16-2BL01, 230 V UC OFF-delay devices

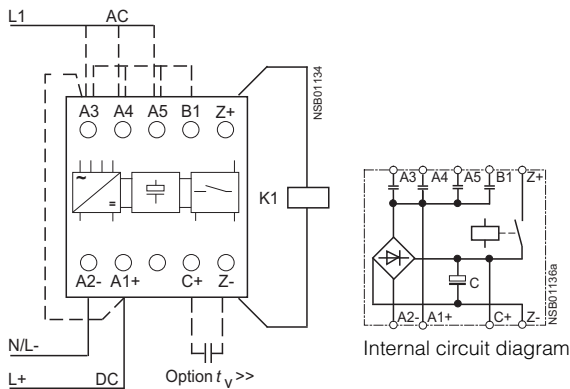

3RT19 16-2BE01, 24 V DC OFF-delay devices

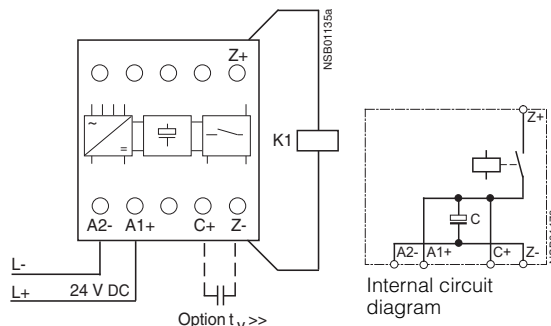

3RT19 16-2BK01, 110 V UC

110 V UC	A1	A3	A4	A5	B1	A2	Z+	Z-	t_v (ms) >
S00 DC	L+					L-			130
50 Hz		L1				N	3RT1. 1.-.BF4. 3RH1. ...-BF4.		130
60 Hz		L1				N			130
S0 DC	L+					L-			100
50 Hz		L1				N	3RT1. 2.-.BF4.		100
60 Hz		L1				N			100

3RT19 16-2BE01, 24 V DC

24 V DC	A1	A2	Z+	Z-	t_v (ms) >
S00	L+	L-	3RT1. 1.-.BB4. 3RH1. ...-BB4.		250
S0	L+	L-	3RT1. 2.-.BB4.		150
S2	L+	L-	3RT1. 3.-.BB4.		90
S3	L+	L-	3RT1. 4.-.BB4.		70

3RT19 16-2BL01, 230 V UC

230 V UC	A1	A3	A4	A5	B1	A2	Z+	Z-	t_v (ms) >
S00 DC	L+					L-			600
50 Hz		L1				N	3RT1. 1.-.BM4. 3RT1. 1.-.BP4. 3RH1. ...-BM4.		600
60 Hz				L1		N	3RH1. ...-BP4.		600
S0 DC	L+					L-			400
50 Hz		L1				N	3RT1. 2.-.BM4. 3RT1. 2.-.BP4.		400
60 Hz				L1		N			400

Operation after OFF-delay

(Contactor only switches off with delay in case of voltage failure)

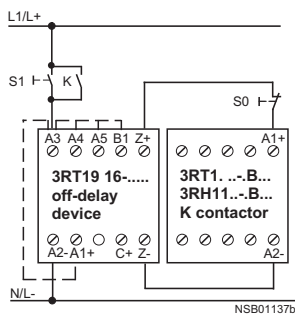

Schematic circuit diagram

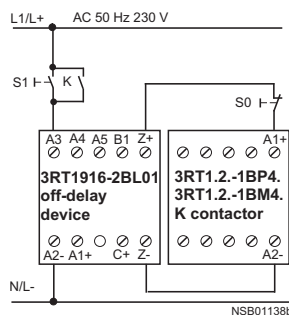

Typical circuit diagram:
Contactor size S0,
DC operation, at AC 50 Hz 230 V

Operation before OFF-delay

(Contactor always switches off with delay)

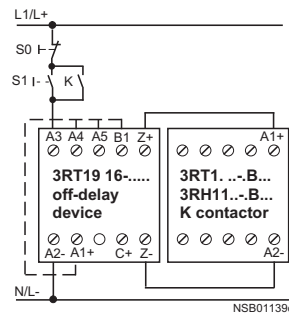

Schematic circuit diagram

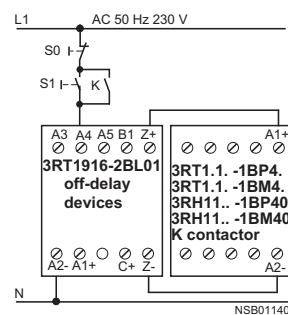

Typical circuit diagram:
Contactor size S00,
DC operation, at AC 50 Hz 230 V

Circuit diagrams for accessories for sizes S00 to S3

Accessories for size S00 to S3 contactors and contactor relays

Solid-state time-delay blocks
(note planning aids on Page 3/167!)

3RT19 16-2C...
With ON-delay
Size S00

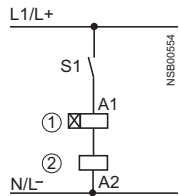

3RT19 16-2D...
OFF-delay (with auxiliary voltage)
Size S00

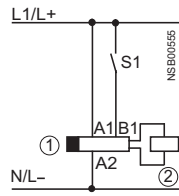

3RT19 26-2C...
With ON-delay
Sizes S0 to S3

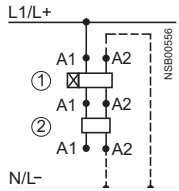

A2 can be connected to N(L-) using either the contactor or the timing relay. --- optionally connect

3RT19 26-2D...
OFF-delay (with auxiliary voltage)
Sizes S0 to S3

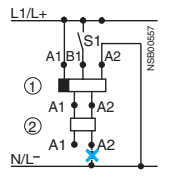

A2 must only be connected to N(L-) from the timing relay.

- ✗ Do not connect
- ① Timing relay block
- ② Contactor

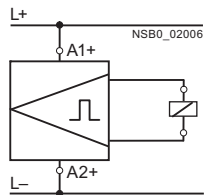

Circuit diagram for railway-type contactors with solid-state coil excitation

3RT16 capacitor contactors

Size S00

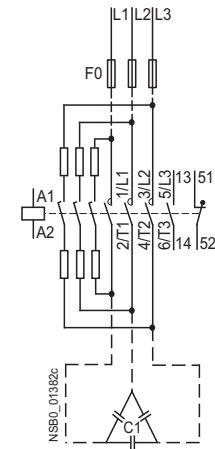

Sizes S0 and S3

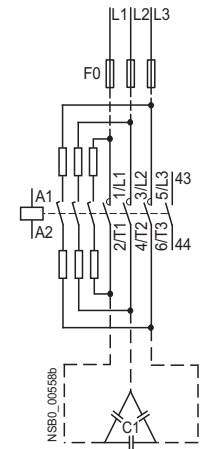

Controls – Contactors and Contactor Assemblies

Project planning aids

Internal circuit diagrams for accessories of size S00 to S3

Contactors with extended operating range 0.7 to 1.25 × U_s

Size S00

Terminal designations according to EN 50012

3RT10 17-2K.42-0LA0 contactors

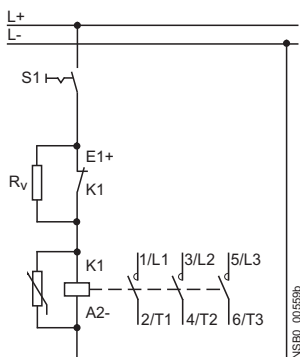

Series resistor R_v plugged on, NC contact prewired.

3RT10 17-2K.41/2K.42 contactor
Varistor integrated
Size S00

1 NO

Ident. No.: 10E

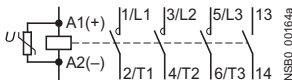

1 NC

01E

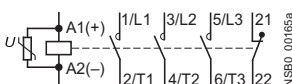

Terminal designations according to EN 50011

3RH11 22-2K.40-0LA0 contactor relays

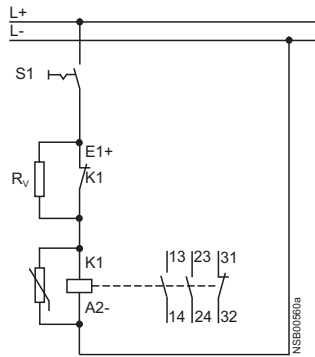

2 NO + 1 NC unassigned
Series resistor R_v plugged on,
NC contact prewired.

3RH11 22-2K.40 contactor relay
Varistor integrated
Size S00

2 NO + 2 NC

22E

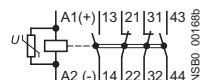

Size S00 to S3

Terminal designations according to EN 50012

3RT10 2.-, 3RT10 3.-,
3RT10 4.-3K.44-0LA0 contactors
with front-mounted 4-pole 3RH19 21-1HA22
auxiliary switch block

2 NO + 2 NC

Ident. No.: 22

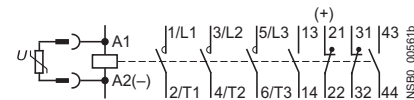

Circuit diagram of the series resistor wiring

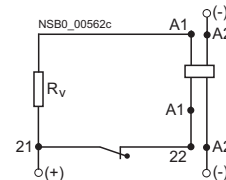

The series resistor is supplied separately packed.
The 21/22 NC contact is necessary to wire the series resistor.

3RT10 25-3K.40 contactor
Varistor integrated
Size S0

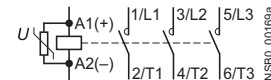

(Two single-pole auxiliary switch blocks can be snapped on)

Position of the terminals for 3RT1 contactors and accessories (valid for screw and Cage Clamp terminals)

Size S00

Terminal designations according to EN 50012

3RT10 1 contactors, 3RT10 1 coupling relays
3RT10 17-2K.4. contactors with extended operating range

1 NO

Ident. No.: 10E

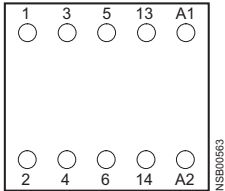

NSB00563

1 NC

01

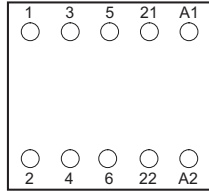

NSB0_00564a

3RT10 1 contactors (with 1 NO contact)
with front-mounted 3RH19 11-.H... auxiliary switch blocks

1 NO + 1 NC

Ident. No.: 11E

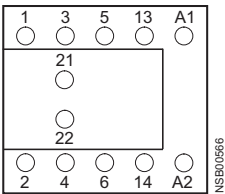

NSB00566

2 NO + 2 NC

22E

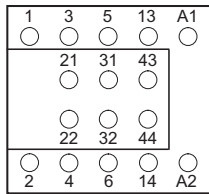

NSB00567

2 NO + 3 NC

Ident. No.: 23E

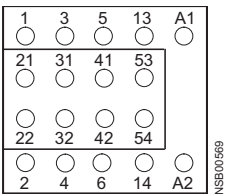

NSB00569

3 NO + 2 NC

32E

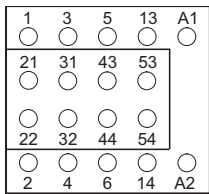

NSB00570

Size S0 to S3

Terminal designations according to EN 50012

3RT10...X.40-OLA2 contactors
with solid-state control unit

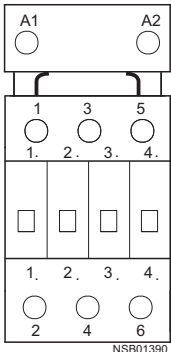

NSB01390

Size S0 to S12

Terminal designations according to EN 50012

3RT10 2, 3RT 10 3,
3RT10 4, 3RT14 46 contactors,
3RT10 2 coupling relays
3RT10 25-3K.40 contactors with
extended operating range

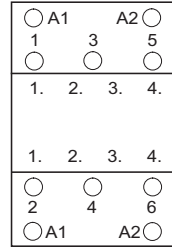

NSB00565

3RT10 2, 3RT10 3, 3RT10 4
contactors
with front-mountable
4-pole 3RH19 21-. HA31
auxiliary switch block

3 NO + 1 NC

Ident. No.: 31 E

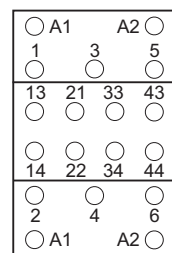

NSB0_01348

First laterally mountable
3RH19 21-.DA11¹⁾
auxiliary switch block
can be mounted on the left or
right

1 NO + 1 NC

Left

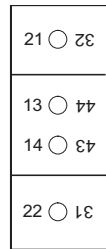

NSB00571

Right

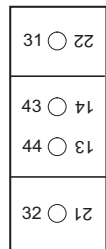

NSB00572

3RT10 2, 3RT10 3, 3RT10 4
contactors
with front-mounted
4-pole 3RH19 21-. HA22
auxiliary switch block

2 NO + 2 NC

Ident. No.: 22 E

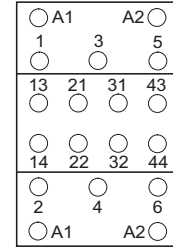

NSB00568

3RT10 2, 3RT10 3, 3RT10 4
contactors
with front-mountable
4-pole 3RH19 21-. HA13
auxiliary switch block

1 NO + 3 NC

13 E

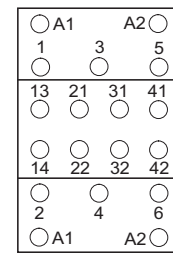

NSB01349

Second laterally mountable
3RH19 21-.JA11¹⁾
auxiliary switch block
can be mounted on the left or
right
(only for sizes S3 to S12)

1 NO + 1 NC

Left

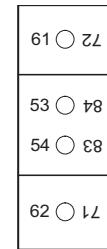

NSB00573

Right

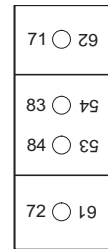

NSB00574

¹⁾ Note location identifier. Can only be used if no 4-pole auxiliary switch block is snapped onto the front.

Project planning aids

Position of the terminals for 3RT1 contactors and accessories (valid for screw and Cage Clamp terminals)

Sizes S6 to S12

3RT1 .5, 3RT1 .6, 3RT1 .7 contactors

- With conventional operating mechanism (3RT1...-A...)

With laterally mountable auxiliary switch blocks
3RH19 21-1DA11 (for 2 NO + 2 NC, included in the contactors)
3RH19 21-1JA11 (can be extended to 4 NO + 4 NC)

2 NO + 2 NC or 4 NO + 4 NC

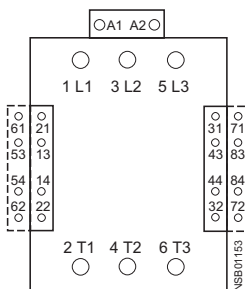

- With solid-state operating mechanism (3RT1...-N...)

With laterally mountable auxiliary switch blocks
3RH19 21-1DA11 (for 2 NO + 2 NC, included in the contactors)
3RH19 21-1JA11 (can be extended to 4 NO + 4 NC)

2 NO + 2 NC or 4 NO + 4 NC

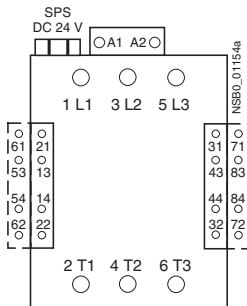

- With solid-state operating mechanism (3RT1...-P...)

With laterally mountable auxiliary switch blocks
3RH19 21-1DA11 (for 1 NO + 1 NC, included in the contactors)
3RH19 21-1JA11 (can be extended to 2 NO + 2 NC)

1 NO + 1 NC or 2 NO + 2 NC

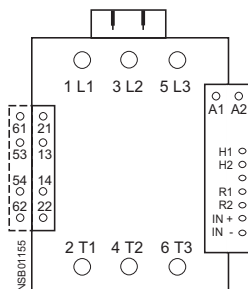

- With solid-state operating mechanism (3RT1...-Q...)

With laterally mountable auxiliary switch blocks
3RH19 21-1DA11 (for 1 NO + 1 NC, included in the contactors)
3RH19 21-1JA11 (can be extended to 2 NO + 2 NC)

1 NO + 1 NC or 2 NO + 2 NC

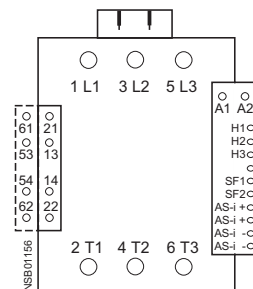

Contactors with 4 main contacts, size S00

Terminal designations according to EN 50005

3RT13 and 3RT15 contactors

4 NO

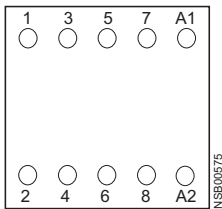

2 NO + 2 NC

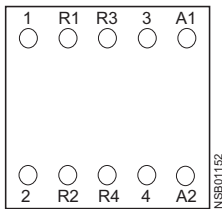

Contactors with 4 main contacts, sizes S0 to S3

Terminal designations according to EN 50005

3RT13 and 3RT15 contactors

4 NO

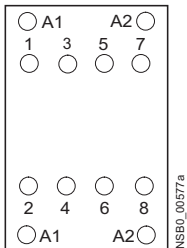

2 NO + 2 NC

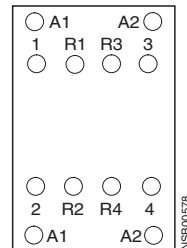

Accessories for size S00 contactors and contactor relays

Terminal designations according to EN 50005

3RH19 11-.F... auxiliary switch blocks and 3RH19 11-.NF... solid-state compatible auxiliary switch blocks for snapping onto the front

2 NO

Ident. No.: 20

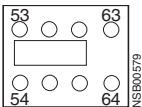

1 NO + 1 NC

11

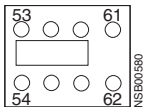

2 NC

02

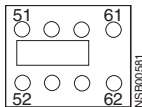

1 NO + 1 NC

11 U

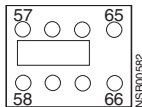

with make-before-break

4 NO

Ident. No.: 40

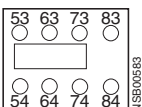

3 NO + 1 NC

31

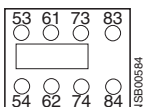

2 NO + 2 NC

22

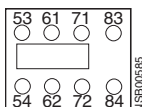

2 NO + 2 NC

22 U

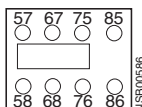

with make-before-break

2 NO + 2 NC

11/11 U

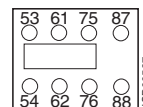

1 NO + 1 NC ON-delay
1 NO + 1 NC with make-before-break

Position of the terminals for 3RT1 contactors and accessories (valid for screw and Cage Clamp terminals)

Accessories for size S00 contactors and contactor relays
Terminal designations according to EN 50005

3RH19 11-1AA...
 auxiliary switch blocks for snapping onto the front
 Cable entry from above

1 NO

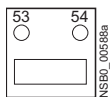

3RH19 11-1LA20

1 NC

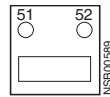

3RH19 11-1LA11

2 NO

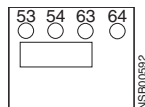

1 NO + 1 NC

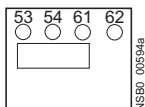

3RH19 11-1BA...
 auxiliary switch blocks for snapping onto the front
 Cable entry from below

1 NO

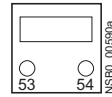

3RH19 11-1MA20

1 NC

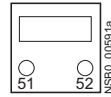

3RH19 11-1MA11

2 NO

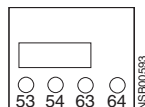

1 NO + 1 NC

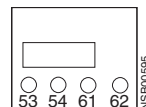

Terminal designations according to DIN 46199 Part 5

3RT19 16-2E.../2F.../2G... solid-state, time-delay auxiliary switch blocks

1 NO + 1 NC

With ON-delay

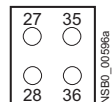

1 NO + 1 NC

OFF-delay

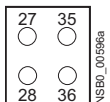

2 NO

Wye-delta function

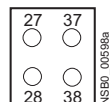

Accessories for size S0 to S12 contactors
Terminal designations according to EN 50005

3RH19 21-.F... auxiliary switch blocks, 4-pole,
 for snapping onto the front

4 NO

Ident. No.: 40

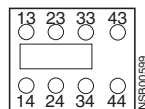

3 NO + 1 NC

31

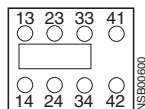

2 NO + 2 NC

22

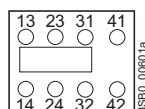

4 NC

04

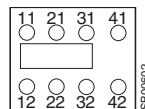

2 NO + 2 NC

22 U

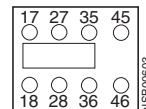

with make-before-break

3RH19 21-1LA... auxiliary switch blocks, 2-pole
 for snapping onto the front, cable entry from the top

2 NO

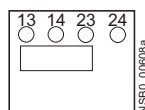

1 NO + 1 NC

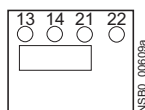

2 NC

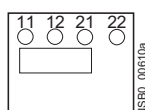

3RH19 21-1MA... auxiliary switch blocks, 2-pole,
 for snapping onto the front, cable entry from the bottom

2 NO

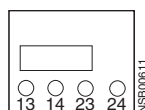

1 NO + 1 NC

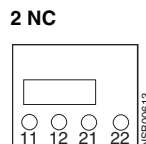
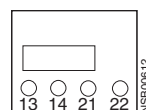

3RH19 21-.FE22 solid-state compatible auxiliary switch block, 4-pole,
 for snapping onto the front

2 NO + 2 NC

Ident. No.: 22

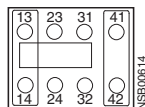

Terminal designations according to EN 50005 or EN 50012

3RH19 21-.CA... auxiliary switch blocks, 1-pole,
 for snapping onto the front

1 NO

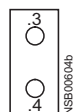

1 NC



1 NO

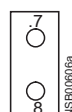

with extended contacting

1 NC



with extended contacting

Controls – Contactors and Contactor Assemblies

Project planning aids

Position of the terminals for 3RT1 contactors and accessories

Accessories for size S0 to S12 contactors Terminal designations according to EN 50005

First laterally mountable 3RH19 21-.EA.. auxiliary switch blocks (left)

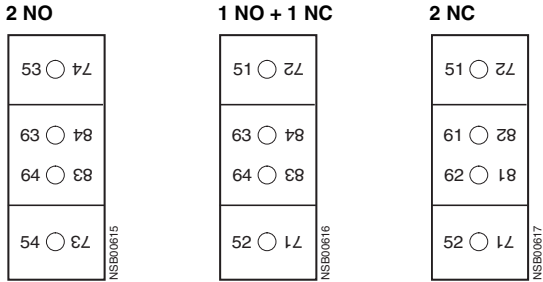

First laterally mountable 3RH19 21-.EA.. auxiliary switch blocks (right)

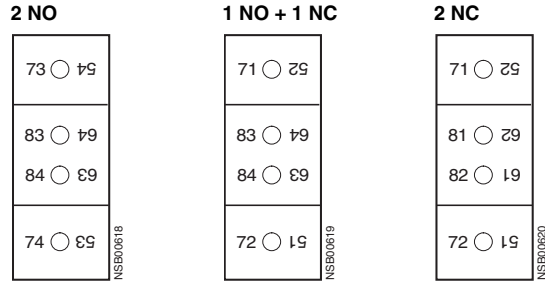

Second laterally mountable 3RH19 21-.KA.. auxiliary switch blocks (left)
(only for sizes S3 to S12; can only be used if no auxiliary switches are snapped onto to the front)

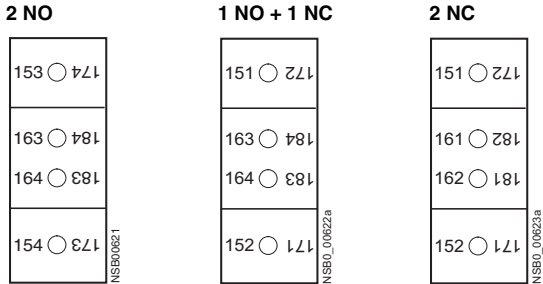

Second laterally mountable 3RH19 21-.KA.. auxiliary switch blocks (right)
(only for sizes S3 to S12; can only be used if no auxiliary switches are snapped onto to the front)

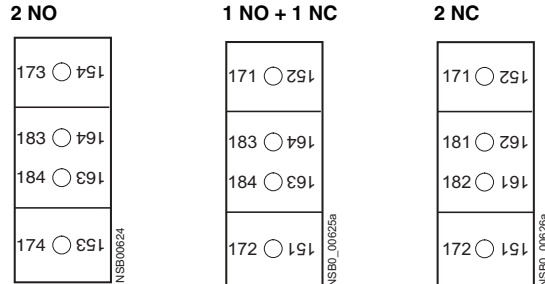

Accessories for size S0 to S12 contactors Terminal designations according to DIN 46199 Part 5

3RT19 26-2E.../2F.../2G... solid-state, time-delay auxiliary switch blocks

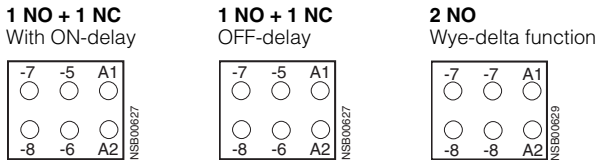

3RT16 capacitor contactors

Size S00
with 4-pole auxiliary switch block mounted on the front

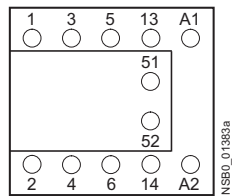

The auxiliary switch block contains 3 leading contacts (not shown), and one unassigned NO contact and one unassigned NC contact.

Size S0 and S3
with 4-pole auxiliary switch block mounted on the front

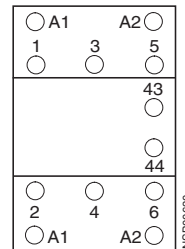

The auxiliary switch block contains 3 leading contacts (not shown) and one unassigned NO contact.

Position of the terminals for 3RT1 contactors and accessories**Contactors with extended operating range 0.7 to 1.25 × U_s
Size S00****Terminal designations according to EN 50012**

3RT10 17-2K.42-0LA0 contactors

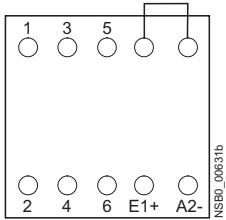

Series resistor R_V plugged on, NC contact prewired.
3RH19 11-2. . . . auxiliary switch blocks according to EN 50005 can be snapped on.

Terminal designations according to EN 50011

3RH11 22-2K.40-0LA0 contactor relays

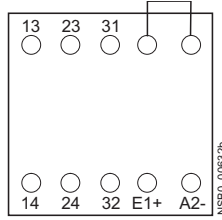

Series resistor R_V plugged on, NC contact prewired.
3RH19 11-2. . . . auxiliary switch blocks according to EN 50005 can be snapped on.

**Contactor relays with extended tolerance 0.7 to 1.25 × U_s
Size S00**

3RH11 22-2K.40 contactor relays

2 NO + 2 NC

Ident. No.: 22 E

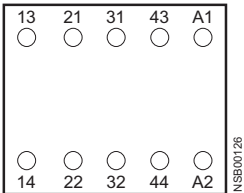

It is not possible to mount an auxiliary switch block.

**Contactors with extended operating range 0.7 to 1.25 × U_s
Size S0 to S3****Terminal designations according to EN 50012**3RT10 2.-, 3RT10 3.-, 3RT10 4.-3K.44-0LA0 contactors
with front 4-pole 3RH19 21-2HA22 auxiliary switch block**2 NO + 2 NC**

Ident. No.: 22 E

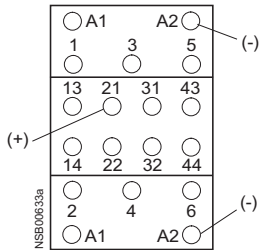

For circuit diagram of the series resistor wiring, see page 3/226.

Note:

For position of terminals for the 3RT10 17-2K.4. and 3RT10 25-3K.40 contactors see page 3/227.

Controls – Contactors and Contactor Assemblies

Project planning aids

Connection diagrams for 3RH1 contactor relays, size S00

Terminal designations according to EN 50011¹⁾

3RH11 contactor relays

4 NO

Ident. No.: 40E

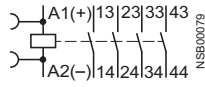

3 NO + 1 NC

31 E

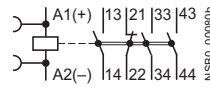

2 NO + 2 NC

22E

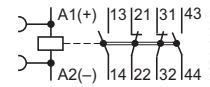

3RH11 40 contactor relays

with 3RH19 11-1GA. . .

3RH12 44, 3RH12 62 auxiliary switch blocks snapped onto the front

8 NO

Ident. No.: 80E

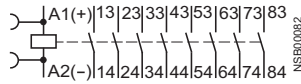

7 NO + 1 NC

71E

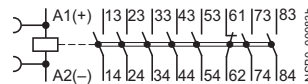

6 NO + 2 NC

62E



5 NO + 3 NC

Ident. No.: 53E

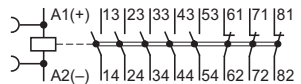

4 NO + 4 NC

44E

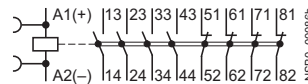

3RH14 latched contactor relays

4 NO

Ident. No.: 40E

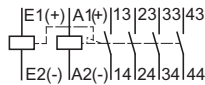

3 NO + 1 NC

31E

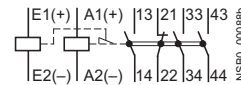

2 NO + 2 NC

22E

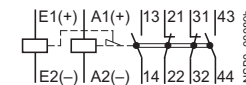

Surge suppressor (plug-in direction coded)

Diode



Diode assembly



Varistor



RC element



Diode with LED



Varistor with LED



¹⁾ Positively-driven operation is assured likewise for auxiliary switch blocks according to EN 50005 in conjunction with 3RH11 contactor relays (basic units).

Connection diagrams for 3TH42 contactor relays with 8 contacts

Terminal designations according to EN 50011

8 NO

Ident. No.: 80E

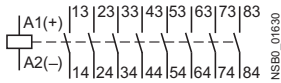

7 NO + 1 NC

71E

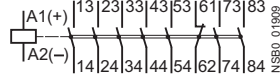

6 NO + 2 NC

62E

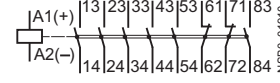

5 NO + 3 NC

Ident. No.: 53E

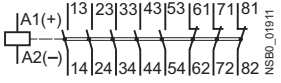

4 NO + 4 NC

44E

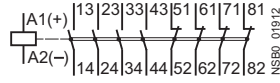

3 NO + 3 NC and 1 NO + 1 NC make-before-break

44E, U

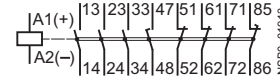

Circuit diagrams for 3TH42 contactor relays with 8 contacts

3TX4 180-0A NTC thermistor module

Switching examples

Momentary-contact operation

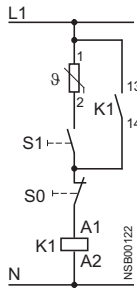

Maintained-contact operation

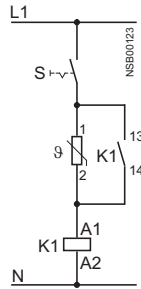

Position of the terminals for 3TH42 contactor relays with 8 contacts

8 NO

Ident. No.: 80E

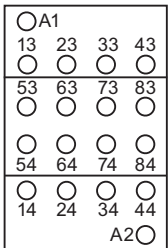

7 NO + 1 NC

71E

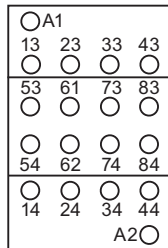

6 NO + 2 NC

62E

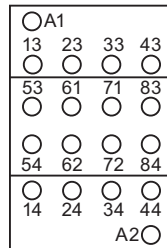

5 NO + 3 NC

53E

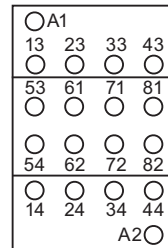

4 NO + 4 NC

44E

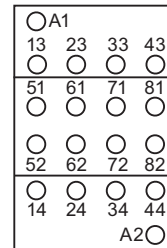

Controls – Contactors and Contactor Assemblies

Project planning aids

Connection diagrams for 3TH43 contactor relays with 10 contacts

Terminal designations according to EN 50011

10 NO

Ident. No.: 100E

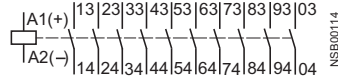

9 NO + 1 NC

91E

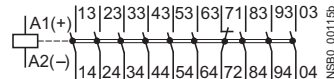

8 NO + 2 NC

82E

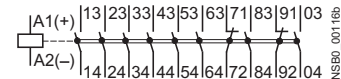

7 NO + 3 NC

Ident. No.: 73E

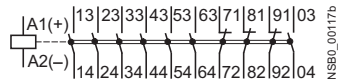

6 NO + 4 NC

64E

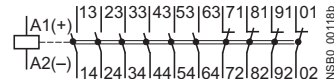

5 NO + 5 NC

55E

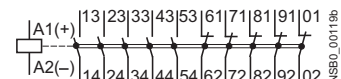

4 NO + 4 NC, 1 NO + 1 NC make-before-break

Ident. No.: 44E/11U

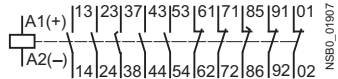

6 NO + 2 NC, 1 NO + 1 NC make-before-break

63E/11U

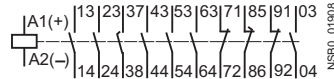

Circuit diagrams for 3TH43 contactor relays with 10 contacts

3TX4 180-0A NTC thermistor module
Switching examples

Momentary-contact operation

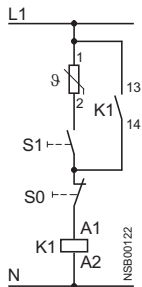

Maintained-contact operation

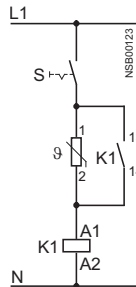

Position of the terminals for 3TH43 contactor relays with 10 contacts

10 NO

Ident. No.: 100E

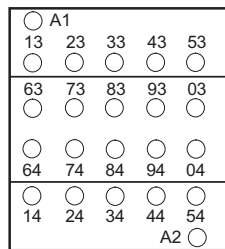

9 NO + 1 NC

91E

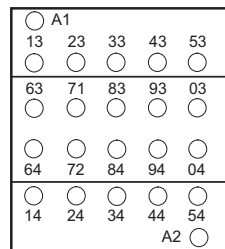

8 NO + 2 NC

82E

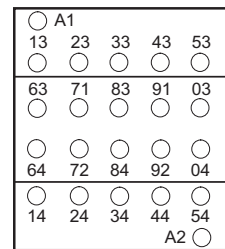

7 NO + 3 NC

73E

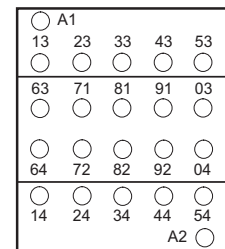

6 NO + 4 NC

Ident. No.: 64E

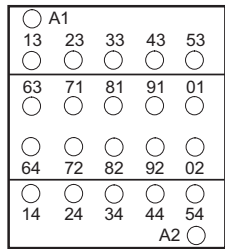

5 NO + 5 NC

55E

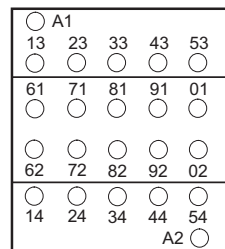

5 NO + 5 NC

55E, U

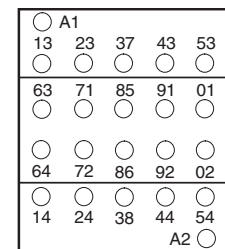

Position of the terminals for 3RH1 contactor relays, size S00

Terminal designations according to EN 50011

3RH11 contactor relays

4 NO

Ident. No.: 40E

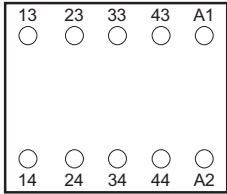

3 NO + 1 NC

31E

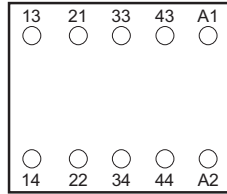

2 NO + 2 NC

22E

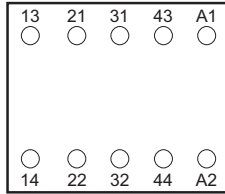

3RH11 40 contactor relays
with 3RH19 11-1GA... 3RH12 44, 3RH12 62
auxiliary switch blocks snapped onto the front

8 NO

Ident. No.: 80E

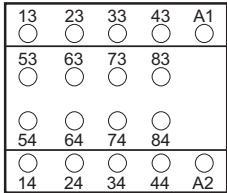

7 NO + 1 NC

71E

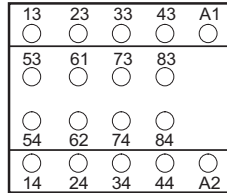

6 NO + 2 NC

62E

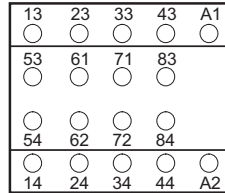

5 NO + 3 NC

53E

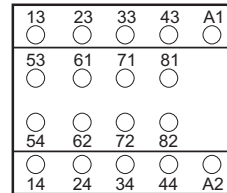

4 NO + 4 NC

Ident. No.: 44E

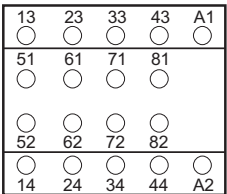

3RH14 latched contactor relays

4 NO

Ident. No.: 40E

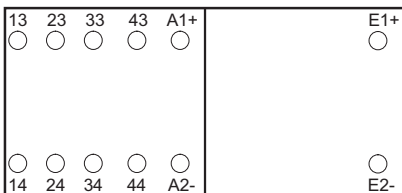

3 NO + 1 NC

31E

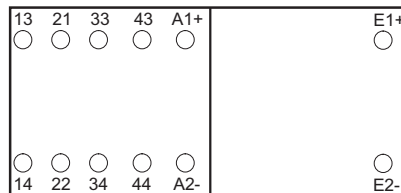

2 NO + 2 NC

Ident. No.: 22E

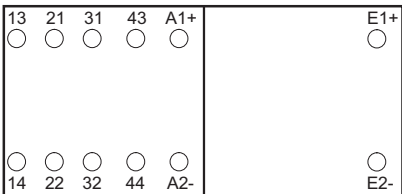

Project planning aids

Connection diagrams for 3RH11 coupling relays for switching auxiliary circuits

DC operation

L+ is to be connected to coil terminal A1.

3RH11 coupling relays for auxiliary circuits, size S00

Terminal designations according to EN 50011

(it is not possible to snap on an auxiliary switch block)

Surge suppressor can be mounted

4 NO

Ident. No.: 40E

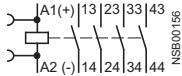

3 NO + 1 NC

31E

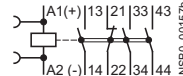

2 NO + 2 NC

22E

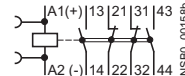

Diode integrated

4 NO

Ident. No.: 40E

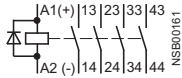

3 NO + 1 NC

31E

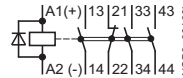

2 NO + 2 NC

22E

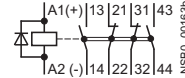

Varistor integrated

4 NO

Ident. No.: 40E

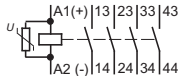

3 NO + 1 NC

31E

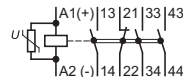

2 NO + 2 NC

22E

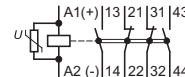

Surge suppressors for size S00 coupling relays

See 3RH11 contactor relays, page 3/232.

Position of the terminals for 3RH11 coupling relays for switching auxiliary circuits

Size S00

3RH11 coupling relays

4 NO

Ident. No.: 40E

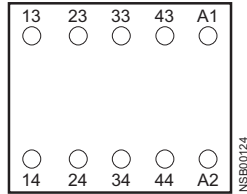

3 NO + 1 NC

31E

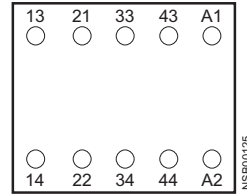

2 NO + 2 NC

22E

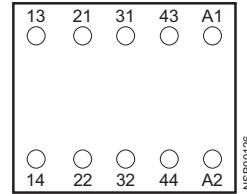

Circuit diagrams for 3RA13 reversing contactor assemblies

Size S00

Main circuit

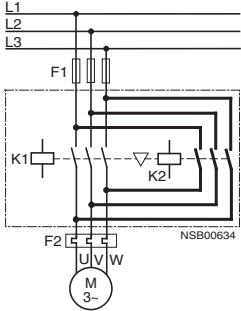

Control circuit

(The terminal designations for the contactors comply with EN 50012)

For momentary-contact operation

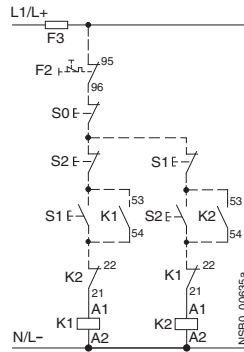

For maintained-contact operation

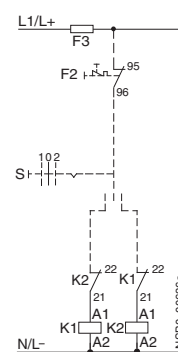

The 3RA19 13-2A assembly kit contains, among other things, wiring connectors for connecting the main circuit.

The 3RA19 13-2A assembly kit contains, among other things, the electrical interlock.

Sizes S0 to S3

Main circuit

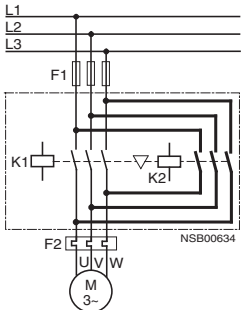

Control circuit

(The terminal designations for the contactors comply with EN 50005)

For momentary-contact operation

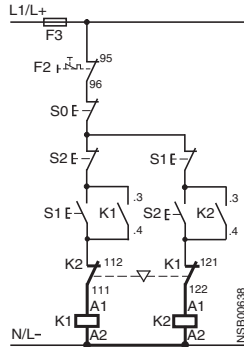

For maintained-contact operation

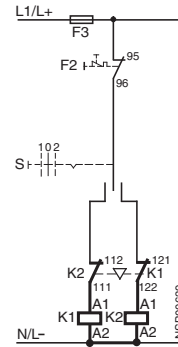

The 3RA19 .3-2A assembly kits contain, among other things, the wiring modules on the top and bottom for connecting the main current paths.

The 3RA19 24-2B mechanical interlock contains one NC contact for each contactor for the NC contact interlock.

Position of the terminals for 3RA13 reversing contactor assemblies

Size S0 to S3

Terminal designations according to EN 50005

3RA19 24-2B mechanical interlock (laterally mountable), integrated in reversing contactor assemblies (reversing starters), contains one NC contact for the electrical interlock for each contactor

2 NC

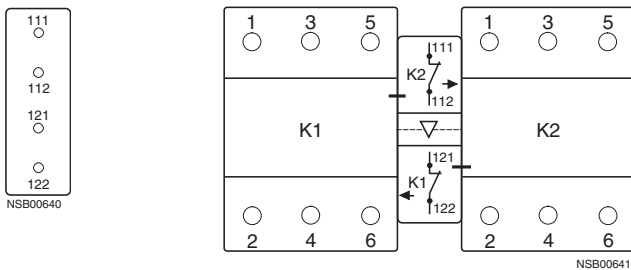

- S0 Button "OFF"
- S1 Button "Clockwise ON"
- S2 Button "Counterclockwise ON"
- S Button "CW-OFF-CCW"
- K1 Clockwise contactor
- K2 Counterclockwise contactor
- F1 Fuses for main circuit
- F3 Fuses for control circuit
- F2 Overload relays

Controls – Contactors and Contactor Assemblies

Project planning aids

Circuit diagrams for 3RA14 wye-delta starting contactor assemblies

Size S00 Main circuit

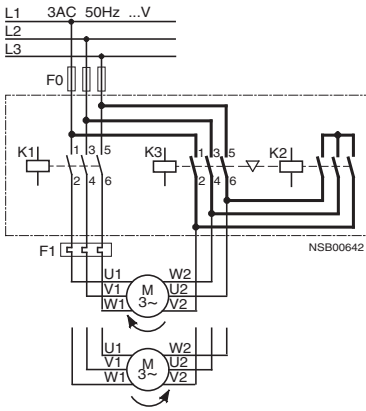

Control circuits with 3RT19 16-2G... solid state time-delay auxiliary switch block, snapped onto the front (example circuits)

For momentary-contact operation

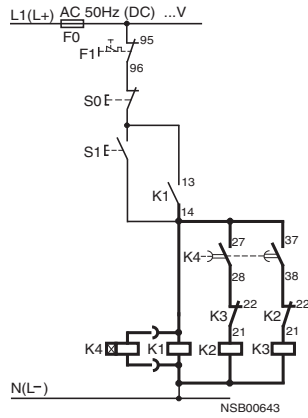

For maintained-contact operation

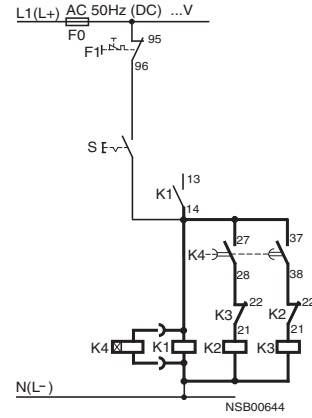

The contact element 27/28 for the solid-state time-delay auxiliary switch block with wye-delta function is only closed on the wye stage; the contact element is open in the delta stage as well as in the de-energized state.

Sizes S0 to S6¹⁾ Main circuit

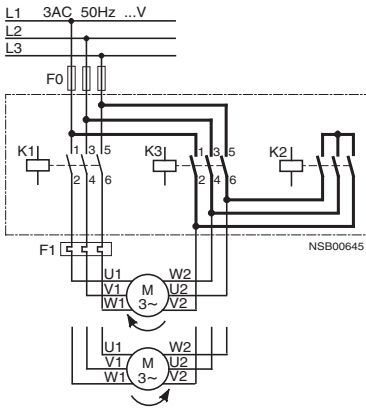

Control circuits with 3RP15 7. timing relay, laterally mounted (example circuits)

For momentary-contact operation

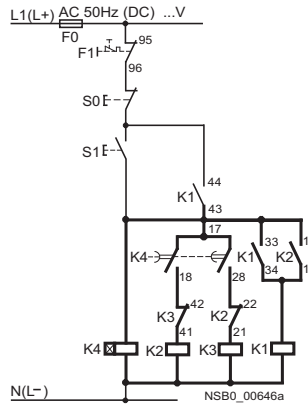

For maintained-contact operation

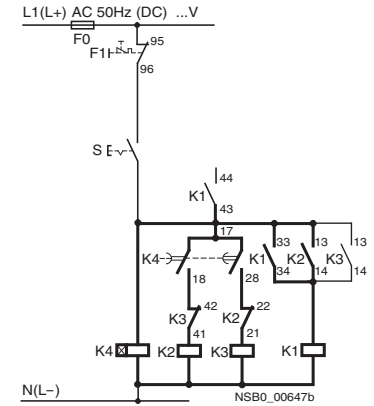

The contact element 17/18 is only closed in the wye stage; the contact element is open in the delta stage as well as in the de-energized state. S1 (S) is connected to clamping point K1/33.

Sizes S6 to S12

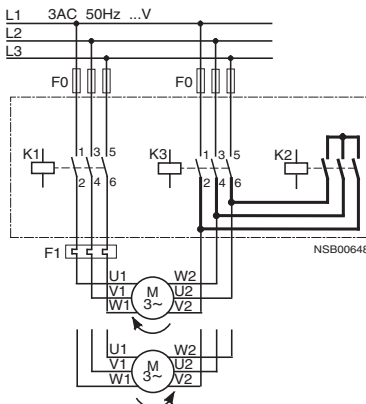

- S0 Button "OFF"
- S1 Button "ON"
- S Maintained-contact switch
- K1 Line contactor
- K2 Star contactor
- K3 Delta contactor
- K4 Solid-state, time-delay auxiliary switch block or timing relay
- F0 Fuses
- F1 Overload relays

¹⁾ Only 3RA19 53-2B assembly kit.

Internal circuit diagrams for 3TG10 miniature contactors

3TG10 10 contactors

1 NO
Ident. No.: 10E

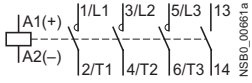

3TG10 01 contactors

1 NC
01E

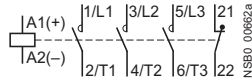

Internal circuit diagrams for 3TF68 and 3TF69 vacuum contactors, 3-pole

3TF68 44 and 3TF69 44 contactors

4 NO + 4 NC
AC operation
Maximum number of auxiliary contacts that can be fitted

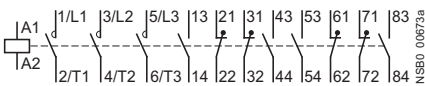

3TF68 33 and 3TF69 33 contactors

3 NO + 3 NC
DC operation
Maximum number of auxiliary contacts that can be fitted

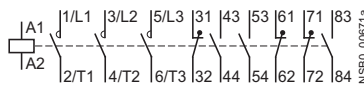

3TY7 681-1G
auxiliary switch blocks
for coil reconnection,
3TF68 and 3TF69,
DC economy circuit



3TY7 561-1AA00
auxiliary switch blocks
1st auxiliary switch block
left or right

Mounted on left Mounted on right



3TY7 561-1KA00
auxiliary switch blocks
2nd auxiliary switch block
left or right

Mounted on left Mounted on right



3TY7 561-1EA00
auxiliary switch blocks
with overlapping contacting

Mounted on left Mounted on right



3TY7 561-1. auxiliary switch blocks
Solid-state compatible auxiliary switch
block

Mounted on left Mounted on right



3TX7 090-0D
coupling links for control by PLC
with surge suppression

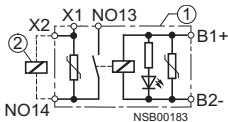

- ① Coupling link
- ② Contactor

Circuit diagrams for 3TF68 and 3TF69 vacuum contactors, 3-pole DC economy circuit · Maintained-contact operation

3TF68 33-.D.4 and 3TF69 33-.D.4 contactors

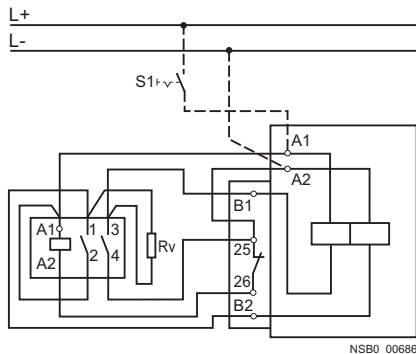

For AC control supply voltage subject to strong interference

3TF68 33-.Q.7 and 3TF69 33-.Q.7 contactors

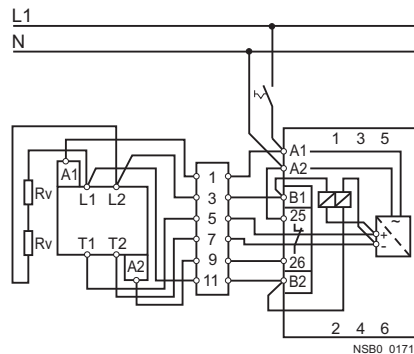

Controls – Contactors and Contactor Assemblies

Project planning aids

Internal circuit diagrams for 3TB50 to 3TB56 contactors, 3-pole

Sizes 6 to 12
3TB50 to 3TB56

DC operation
Auxiliary contacts: **2 NO + 2 NC**

Auxiliary switch block
3TY6 501-1E, 3TY6 561-1E

With overlapping
contacting

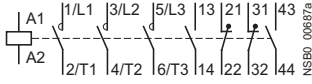

Circuit diagrams for 3TD68 reversing contactor assemblies

Main circuit

In the main circuit the connections are made between contactors K1 and K2.

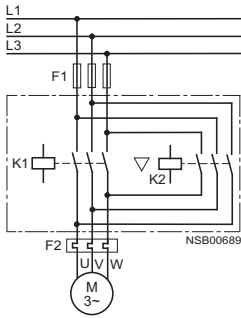

Control circuits

The control circuit cables indicated by broken lines are not wired in the factory.

Momentary-contact operation

Maintained-contact operation

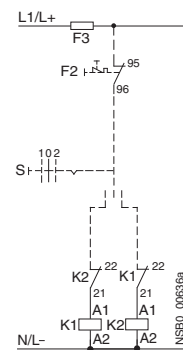
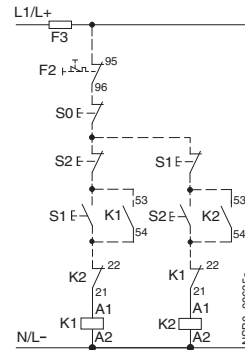

Terminal designations of the unassigned auxiliary contacts

Contactor assembly	With electrical interlock				Without electrical interlock			
	Contactor K1 NO contact	Contactor K1 NC contact	Contactor K2 NO contact	Contactor K2 NC contact	Contactor K1 NO contact	Contactor K1 NC contact	Contactor K2 NO contact	Contactor K2 NC contact
3TD68	13 - 14	21 - 22	13 - 14	31 - 32	13 - 14	21 - 22	13 - 14	21 - 22
	43 - 44	61 - 62	43 - 44	61 - 62	43 - 44	31 - 32	43 - 44	31 - 32
	53 - 54	71 - 72	53 - 54	71 - 72	53 - 54	61 - 62	53 - 54	61 - 62
	83 - 84		83 - 84		83 - 84	71 - 72	83 - 84	71 - 72

- S0 Button "OFF"
- S1 Button "Clockwise ON"
- S2 Button "Counterclockwise ON"
- S Button "CW-OFF-CCW"
- K1 Clockwise contactor
- K2 Counterclockwise contactor
- F1 Fuses for main circuit
- F3 Fuses for control circuit
- F2 Overload relays

Circuit diagrams for 3TE68 wye-delta starting contactor assemblies

Main circuit

Single infeed

Without main conducting path connection between line and delta contactors

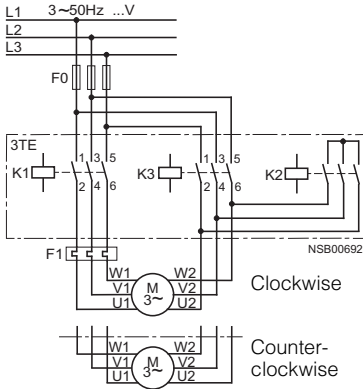

Double infeed

Without main conducting path connection between line and delta contactors

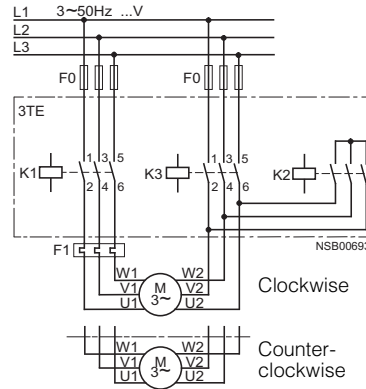

Control circuit with 3RP1 574 timing relay

For momentary-contact operation

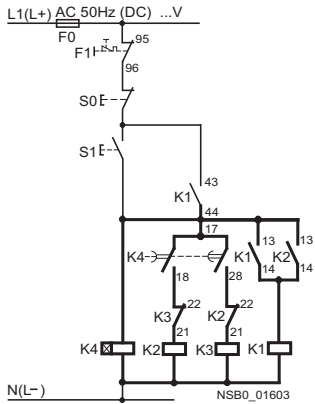

For maintained-contact operation

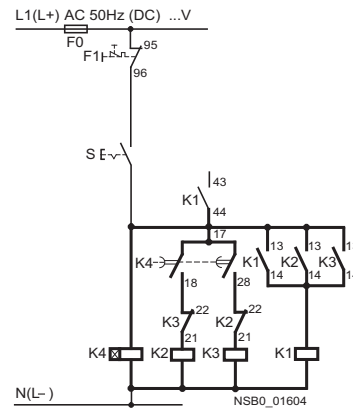

The contact element 17/18 is only closed in the wye stage; the contact element is open in the delta stage as well as in the de-energized state.

- S0 Button "OFF"
- S1 Button "ON"
- S Maintained-contact switch
- K1 Line contactor
- K2 Star contactor
- K3 Delta contactor
- K4 Timing relay
- F0 Fuses
- F1 Overload relays

Internal circuit diagrams for 3TK1 contactors, 4-pole (4 NO) for switching resistive loads (AC-1)

3TK1 contactors

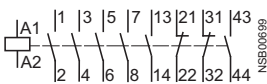

3TK1 910-3B
auxiliary switch block
Mounted on left



Mounted on right



Controls – Contactors and Contactor Assemblies

Project planning aids

Internal circuit diagram for 3TC44 to 3TC56 contactors for switching DC voltage

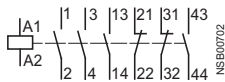

Internal circuit diagrams for 3TC74, 3TC78 contactors for switching DC voltage

DC operation

3TC74 contactors

Auxiliary contacts **4 NO + 4 NC**

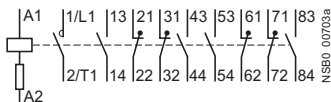

3TC78 contactors

Auxiliary contacts **4 NO + 4 NC**

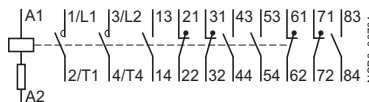

AC operation

Auxiliary contacts **4 NO + 4 NC**

Must be operated in the DC circuit

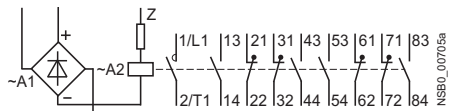

Auxiliary contacts **4 NO + 4 NC**

Must be operated in the DC circuit

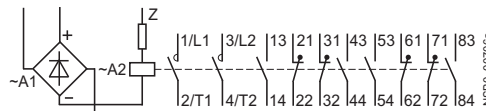

Circuit diagrams for 3TC74, 3TC78 contactors for switching DC voltage

3TC74 contactors

Momentary-contact operation

DC operation

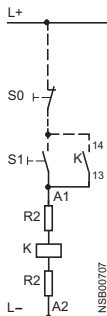

Maintained-contact operation

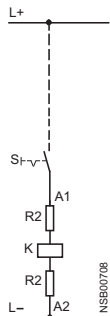

Momentary-contact operation

AC operation (must be operated in the DC circuit)

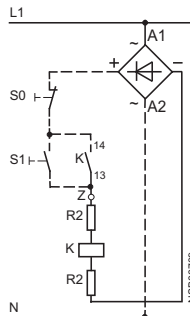

Maintained-contact operation

AC operation (must be operated in the DC circuit)

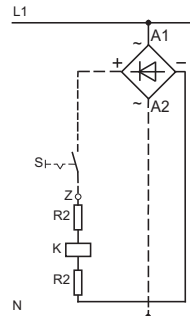

3TC78 contactors

Momentary-contact operation

DC operation

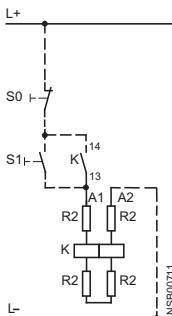

Maintained-contact operation

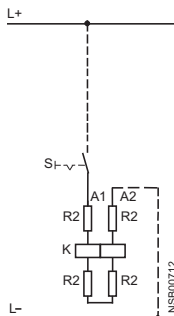

Momentary-contact operation

AC operation (must be operated in the DC circuit)

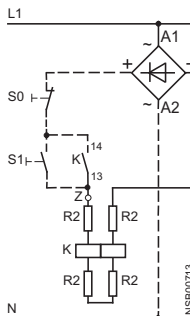

Maintained-contact operation

AC operation (must be operated in the DC circuit)

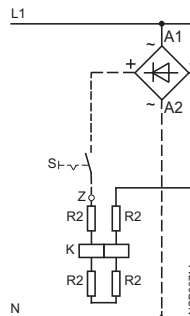

Circuit diagrams for 3T contactors with extended operating range 0.7 to 1.25 x U_s

Circuit with series resistor Rv (size 2 or larger) without reversing contactor

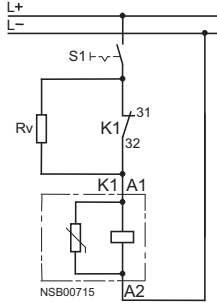

Circuit with series resistor Rv and reversing contactor K2 (for K1 contactors size 8 or larger)

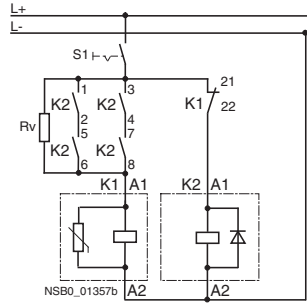

Rv: Two resistors are connected in series for 3TB54, 3TB56 and 3TC56 contactors.

K2: For 3TB52 to 3TB56 and 3TC52 to 3TC56: 3RT13 17-1F . 40

Position of the terminals for 3TG10 miniature contactors

3TG10 10 contactors

1 NO

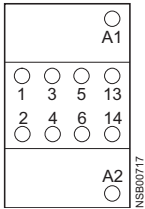

3TG10 01 contactors

1 NC

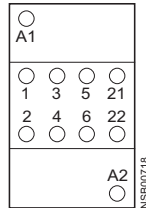

Position of the terminals for 3TF68 and 3TF69 vacuum contactors, 3-pole

AC operation

3TF68 and 3TF69 contactors

4 NO + 4 NC

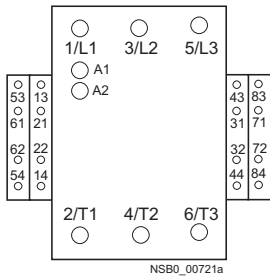

DC operation

3TF68 and 3TF69 contactors

3 NO + 3 NC

Maximum number of auxiliary contacts that can be fitted

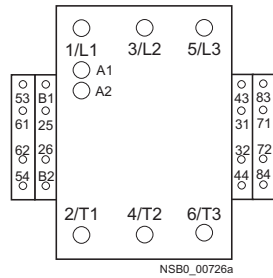

3TY7 561-1 . solid-state compatible auxiliary switch blocks for lateral mounting



Controls – Contactors and Contactor Assemblies

Project planning aids

Position of the terminals for 3TB50 to 3TB56 contactors, 3-pole

Size 6 to 12
3TB50 to 3TB56 contactors

2 NO + 2 NC

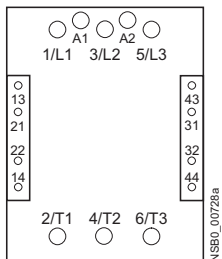

Position of the terminals for 3TK1 contactors for switching resistive loads (AC-1)

3TK10 to 3TK17 contactors

2 NO + 2 NC

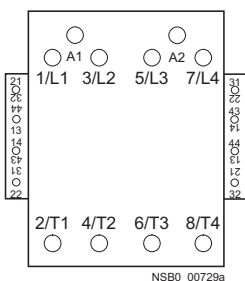

Position of the terminals for 3TC contactors for switching DC voltage

AC and DC operation

Size 2
3TC44 contactors

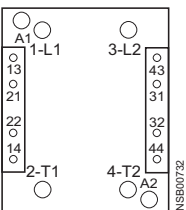

Sizes 4, 8 and 12
3TC48 to 3TC56 contactors

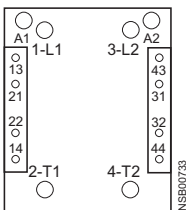

DC operation
3TC74 contactors

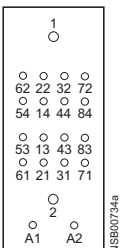

AC operation
3TC74 contactors

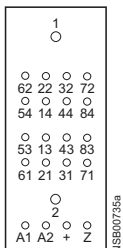

DC operation
3TC78 contactors

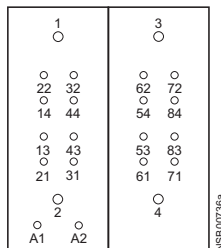

AC operation
3TC78 contactors

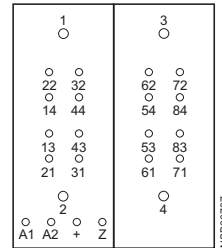

Internal circuit diagrams for 3TF2 and 3TK2 contactors

Terminal designations according to EN 50012

3TF20 ...-0 and 3TF28 ...-0 contactors with AC and DC operation

1 NO
Ident. No.: 10E

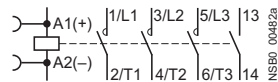

1 NC
01E

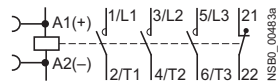

3TF20 ...-3, 3TF20 ...-6 and 3TF20 ...-7 contactors with AC and DC operation

1 NO
Ident. No.: 10E

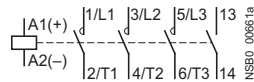

1 NC
01E

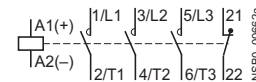

3TF20 10 contactors with 3TX4 4 ...-1 auxiliary switch block, 3TF22 and 3TF29 contactors with AC and DC operation

1 NO + 1 NC
Ident. No. 11E

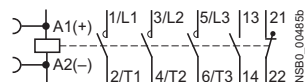

2 NO + 2 NC
22E

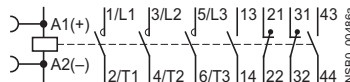

2 NO + 3 NC
Ident. No.: 23E

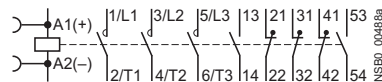

3 NO + 2 NC
32E

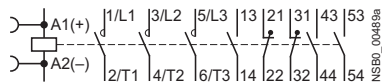

Terminal designations according to EN 50005

3TX4 4 ...-2 auxiliary switch block

4 NO
Ident. No.: 40

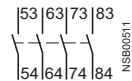

3 NO + 1 NC
31

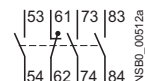

2 NO + 2 NC
22

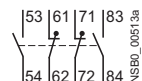

2 NO + 2 NC
22U

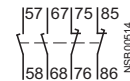

with make-before-break

2 NO
Ident. No.: 20



1 NO + 1 NC
11



2 NC
02



1 NO + 1 NC
11U



with make-before-break

3TK20 contactors

4 NO

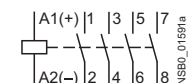

3 NO + 1 NC

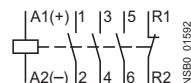

2 NO + 2 NC

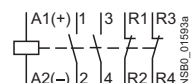

Surge suppressors

Diode



Diode assembly



Varistor



RC element



Diode with LED



Varistor with LED



Project planning aids

Internal circuit diagrams for 3TH2 contactor relays and 3TH27 latched contactor relays

Size S00

Terminal designations according to EN 50011

3TH20 ...0 contactor relays,
AC and DC operation,
with screw terminals

4 NO

Ident. No.: 40E

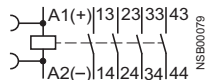

3 NO + 1 NC

31E

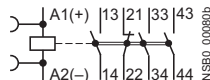

2 NO + 2 NC

22E

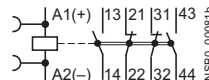

3TH20 ...-3, 3TH20 ...-6, 3TH20 ...-7 contactor relays,
AC and DC operation,
with flat connectors 6.3 mm x 0.8 mm and solder pin connections

4 NO

Ident. No.: 40E

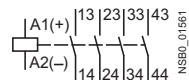

3 NO + 1 NC

31E

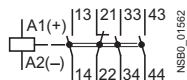

2 NO + 2 NC

22E

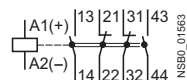

3TH20 40 contactor relays with 3TX4 4 ...0 auxiliary switch block and 3TH22 contactor relay

8 NO

Ident. No.: 80E

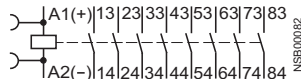

7 NO + 1 NC

71E

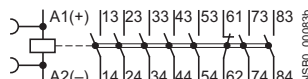

6 NO + 2 NC

62E

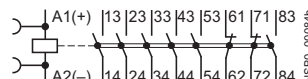

5 NO + 3 NC

Ident. No.: 53E

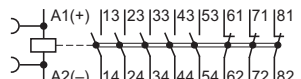

4 NO + 4 NC

44E

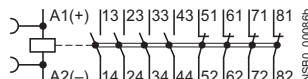

3TH27 latched contactor relays,
AC and DC operation

4 NO

Ident. No.: 40E

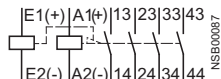

3 NO + 1 NC

31E

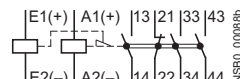

2 NO + 2 NC

22E

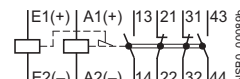

Terminal designations according to EN 50005

3TX4 4 ...2 auxiliary switch block

Positively-driven operation is assured likewise for auxiliary switch blocks according to EN 50005 in conjunction with 3TH20 contactor relays (basic units).

4 NO

Ident. No.: 40

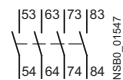

3 NO + 1 NC

31

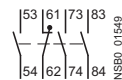

2 NO + 2 NC

22

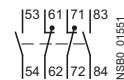

2 NO + 2 NC

22U

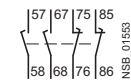

with make-before-break

2 NO

Ident. No.: 20



1 NO + 1 NC

11



2 NC

02



1 NO + 1 NC

11U



with make-before-break

Surge suppressors

Diode



Diode assembly



Varistor



RC element



Diode with LED



Varistor with LED



Relay couplers – connection diagrams for 3TX7 002/3TX7 003

Terminal designations according to EN 50005

3TX7 002-.A.00
3TX7 002-1AB02
3TX7 002-2AF05
3TX7 003-.A.00

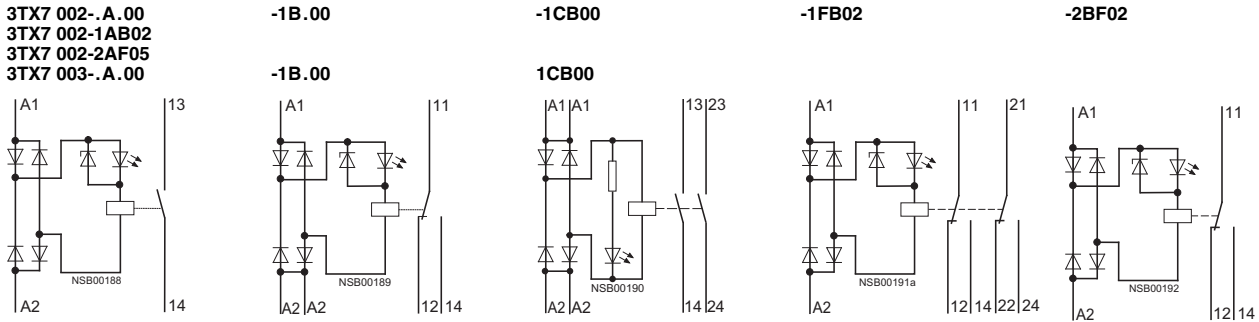

Relay couplers – position of the terminals

Output coupling links

3TX7 002-1AB0.
3TX7 003-1AB00

-1B.00
-1B.00

-1CB00
-1CB00

-1FB02

Input coupling links

3TX7 002-2A.0.
3TX7 003-2A.0.

-2BF02

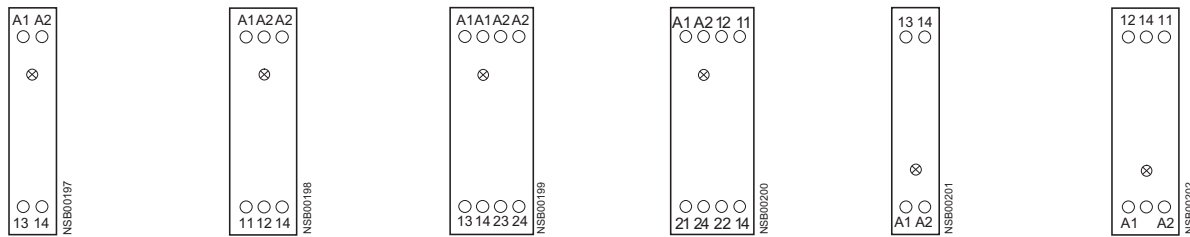

Relay couplers – connection diagrams for 3TX7 004/3TX7 005

Output coupling links

3TX7 00.-1M.00

3TX7 00.-1AB10

3TX7 00.-1BB00
3TX7 00.-1BF05

3TX7 00.-1L.0.

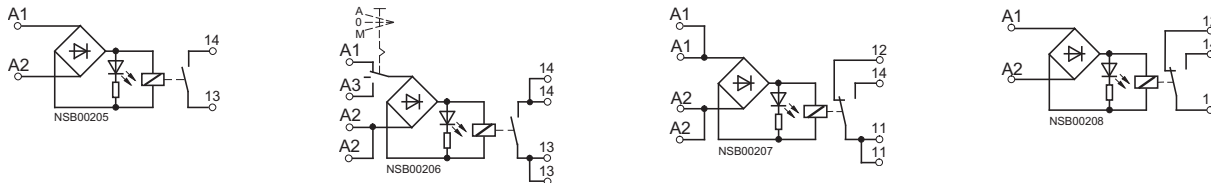

3TX7 00.-1BB10

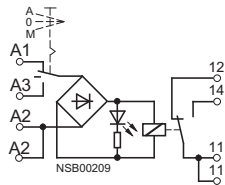

A = Automatic
0 = Neutral position
M = Manual

Input coupling links

3TX7 00.-2M.02

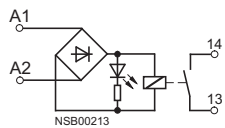

Controls – Contactors and Contactor Assemblies

Project planning aids

Relay couplers – position of the terminals

Output coupling links

3TX7 004
-1M.00



-1L.0.

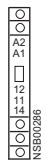

-1AB10

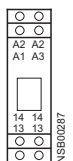

-1B.0.

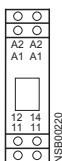

-1BB10

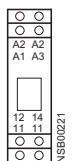

-1CB00

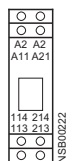

-1HB00

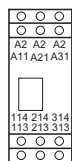

-1GB00



Input coupling links
3TX7 004-2M...

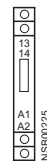

3TX7 005
-1M.00



-1L.0.



-1AB10

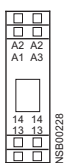

-1BB00

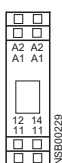

-1BB10

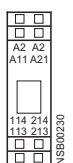

-1CB00

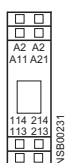

-1HB00

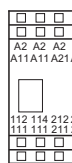

-1GB00

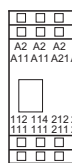

3TX7 005-2M...

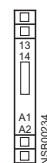

Semiconductor couplers – connection diagrams

Terminal designations according to EN 50005

3TX7 002-3AB00

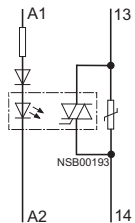

-3AB01

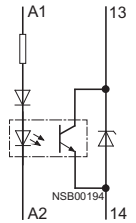

-4AB00

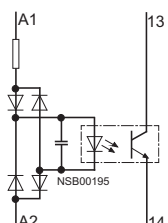

-4AG00

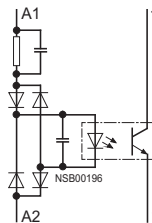

Semiconductor couplers – position of the terminals

Output coupling links

3TX7 002-3AB0.

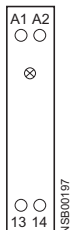

Input coupling links

3TX7 002-4A.0.

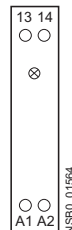

Semiconductor couplers – connection diagrams

Output coupling links

3TX7 00.-3AB04
3TX7 00.-3PB41

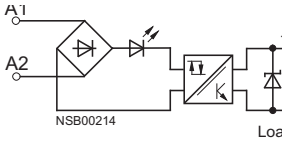

3TX7 00.-3PB54
3TX7 00.-3PG74
3TX7 00.-3PB74

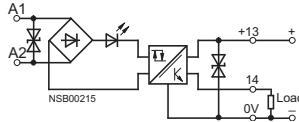

3TX7 00.-3AC04

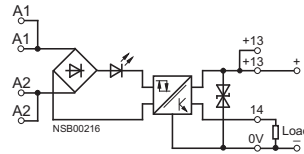

3TX7 00.-3AC14

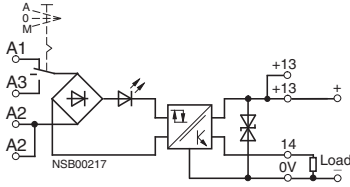

3TX7 00.-3AC03

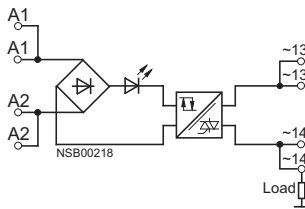

Input coupling links

3TX7 00.-4AB04

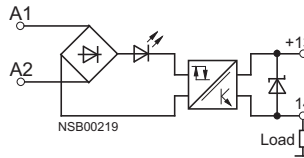

A= Automatic
0= Neutral position
M= Manual

Semiconductor couplers – position of the terminals

Output coupling links

3TX7 004
-3AB04,
-3PB41



-3PB54,
-3PB74,
-3PG74

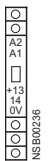

-3AC04

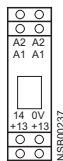

-3AC14

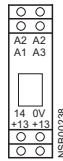

-3AC03

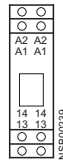

Input coupling links

3TX7 004-4AB04



3TX7 005
-3AB04,
-3PB41



-3PB54,
-3PB74,
-3PG74

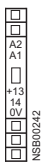

-3AC04



-3AC14

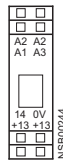

-3AC03



3TX7 005-4AB04



3RS18 coupling relays with industrial housing – position of the terminals

3RS18 00
-.AP00
-.AQ00

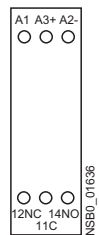

3RS18 00
-.BP00
-.BQ00

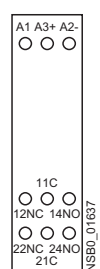

3RS18 00
-.HP0.
-.HQ0.

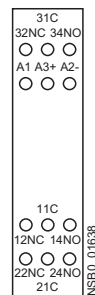

3RS18 00
-.BW00

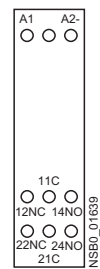

3RS18 00
-.HW0.



Controls – Contactors and Contactor Assemblies

Project planning aids

LZX plug-in relays – relay couplers

LZX:PT270
2-pole

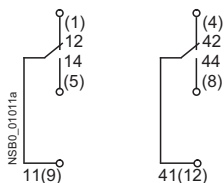

LZX:PT370
3-pole

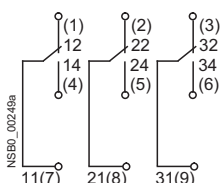

LZX:PT520, LZX:PT570, LZX:PT580
4-pole

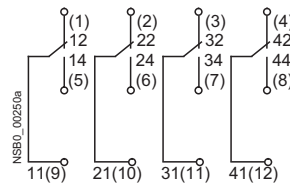

LZX:RT3
1-pole

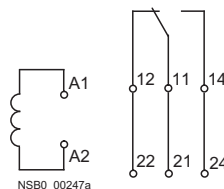

LZX:RT4
2-pole

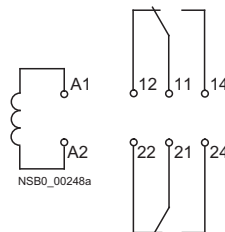

LZX:MT32
3-pole

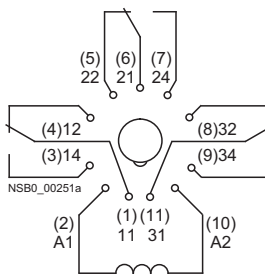

Values in brackets: socket designations.
Without brackets: contact/coil designations.

Position of the connection terminals

Standard plug-in bases for PT series

LZS:PT78720

for 2 CO contacts, with screw terminals

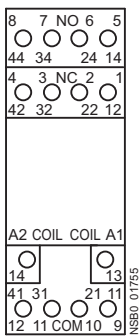

LZS:PT78730

for 3 CO contacts, with screw terminals

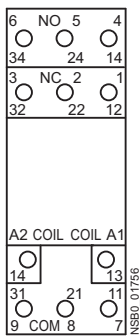

LZS:PT78740

for 4 CO contacts, with screw terminals

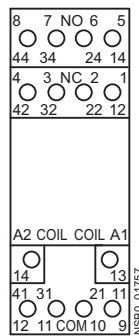

Plug-in bases with logical isolation for PT series

LZS:PT78722
for 2 CO contacts,
with screw terminals

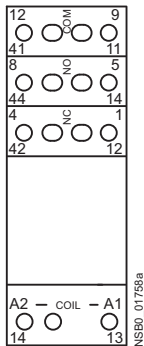

LZS:PT78742
for 4 CO contacts,
with screw terminals

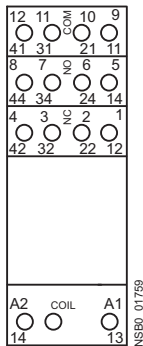

LZS:PT7872P
for 2 CO contacts,
with spring-type terminals

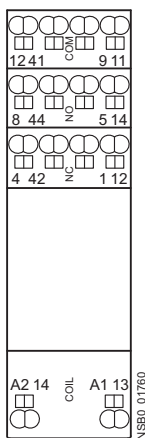

LZS:PT7874P
for 4 CO contacts,
with spring-type terminals

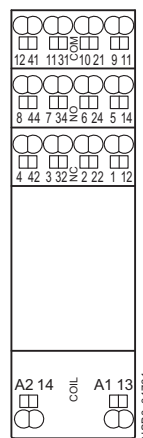

Plug-in bases for RT series

LZS:RT78725
with screw terminals



LZS:RT78726
with logical isolation and
screw terminals

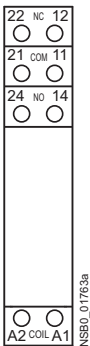

LZS:RT7872P
with logical isolation and spring-type
terminals



Plug-in bases for MT series

LZS:MT78750
for industrial relays

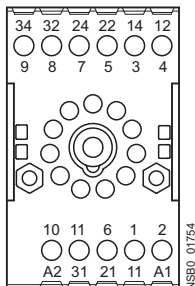

Controls – Contactors and Contactor Assemblies

Notes

3

Controls – Solid-State Switching Devices

4



4/2	Introduction
4/3	Solid-State Switching Devices General data
4/4	Solid-State Switching Devices for Resistive Loads General data <u>Solid-State Relays</u>
4/6	General data
4/7	3RF21 solid-state relays, single-phase, 22.5 mm
4/13	3RF20 solid-state relays, single-phase, 45 mm
4/17	3RF22 solid-state relays, three-phase, 45 mm <u>Solid-State Contactors</u>
4/23	General data
4/24	3RF23 solid-state contactors, single-phase
4/33	3RF24 solid-state contactors, three-phase <u>3RF29 Function Modules</u>
4/42	General data
4/44	Converters
4/45	Load monitoring
4/46	Heating current monitoring
4/47	Power controllers
4/48	Power regulators
4/49	Project planning aids
4/51	Solid-State Switching Devices for Switching Motors <u>Solid-State Contactors</u> General data
4/53	3RF24 solid-state contactors, three-phase
4/59	3RF24 solid-state reversing contactors, three-phase