

# The essential guide of Automation & Control

2012



# The go to guide

for the most efficient selection

Make the most of your energy

# Contents

## Operator dialog

- Control and signalling units
- Human/Machine Interfaces
- Dialog operator for Explosive atmospheres

1

## Automation

- Relays
- Controllers for commercial and industrial machines
- Programmable Automation Controllers (PACs)
- Configuration software

2

## Motion and Drives

- Soft starters and variable speed drives
- Controllers, drives, motors and linear motion axes

3

## Motor control

- Motor control components
- Components for power control applications

4

## Power supplies

- Power supplies
- Transformers
- Connection

5

## Interfaces and I/O

- Distributed Inputs/Outputs
- Distributed I/O with embedded control
- Interfaces
- Accessories and Cabling

6

## Networks connectivity and Web servers

- ConneXium cabling system
- AS-Interface cabling system
- Servers and Gateways

7

## Machine safety

- Safety solutions provide maximum protection in all the safety functions of your automation system

8

# Innovative and simple products for all **Autom**

## Interfaces & I/O

### Connectors

Cable-ends, terminal blocs

### Interfaces

Plug-in relays, analog converters, discrete interfaces

Pre-wired interfaces, IP20/IP67 distributed I/O

### AS-Interface

IP20/IP67 interfaces, cables, repeaters, accessories, addressing and adjustment terminals

### Machine safety

Safety monitors and controllers on AS-Interface

### Software

Software to design and install AS-Interface system, safety monitors and controllers on AS-Interface programming software

## Mounting systems

### Enclosures

Wall mounted enclosures  
Floor standing enclosures, suite type cubicles  
Industrial boxes

### Equipment and accessories

Thermal control equipment  
Power splitter blocks  
Mounting accessories

## Power supplies

### Power supplies

Switch mode power supplies  
Filtered rectified power supplies, transformers

### AS-Interface

Power supplies



## Automation

### Relays

Plug-in relays, electronic timers, control relays, counts  
Smart relays

### PLCs, PC based control, distributed I/O

Programmable controllers  
PLC platforms  
PC based control  
Distributed I/O, I/O controllers

### AS-Interface

Master modules for Modicon PLCs

### Machine safety

Safety PLCs, controllers and modules

### Software

PLCs and safety controllers programming software

## Systems & Architectures

Connecting Ethernet devices

Web-enabling PLCs on Ethernet

Application protocols and field buses

# ation and Control functions

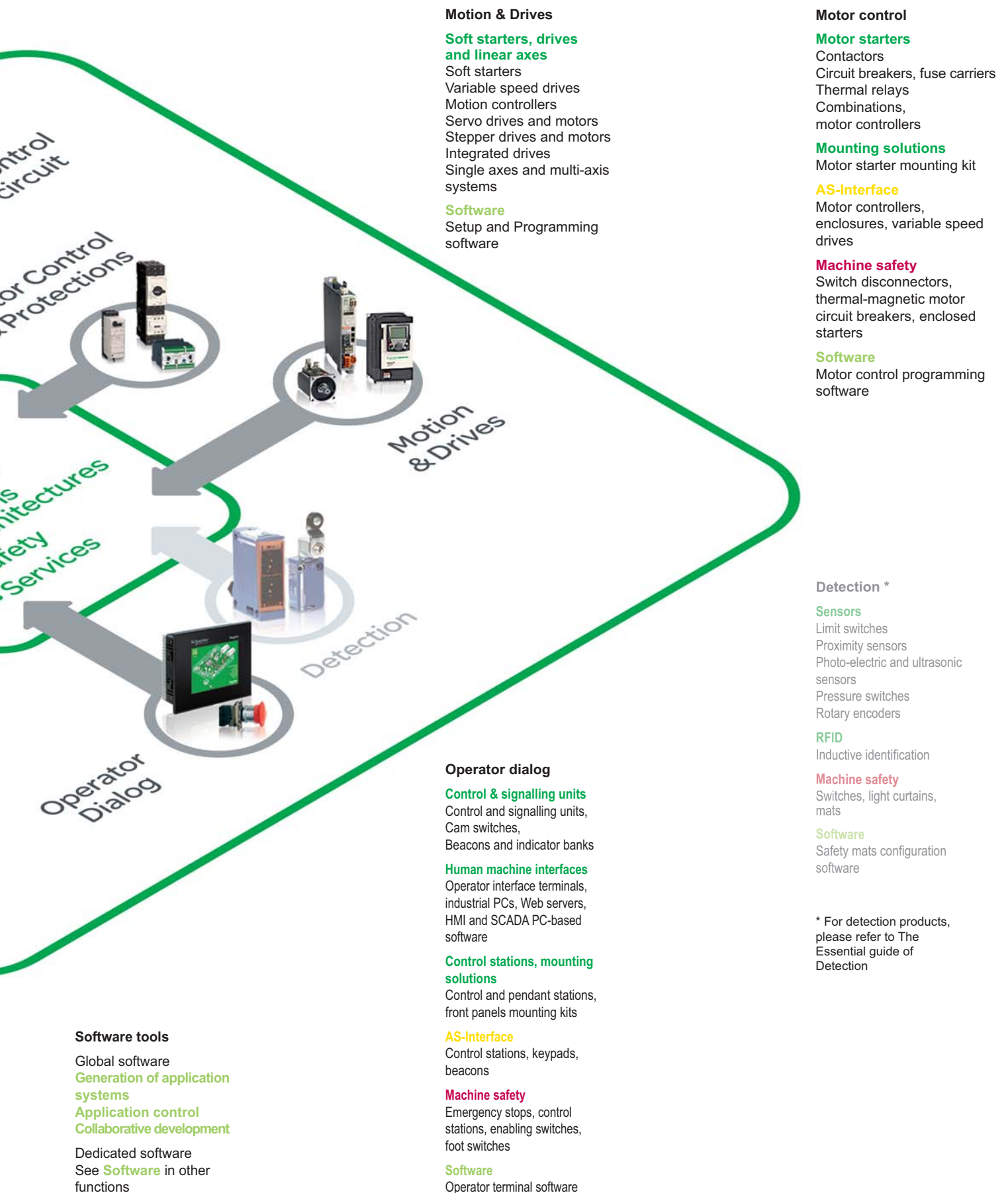

# Harmony

Harmony control and signalling products are characterised by their extreme ruggedness, ergonomic design and ease of use, all of which have contributed to their successful application worldwide. The unrivalled depth of the Harmony range provides solutions to meet the diverse needs of your applications.



From the humble pushbutton to the most complex operator dialogue terminal, Schneider Electric is the world's leading supplier of human-machine interface components. Open-ended and highly innovative, the Harmony and Magelis ranges are synonymous with seamless integration and effective configuration solutions in dialogue applications.



## HMI Magelis

A comprehensive, rugged, open-ended interface and industrial PC offer to meet your requirements in a wide variety of applications. With its extensive capabilities, Magelis ensures the dependability of your installations.

# 1 | Operator dialog



## Control and signalling units

### **Pushbuttons, switches, pilot lights & control stations**

|  |              |
|--|--------------|
| Ø 16, plastic bezel, <b>Harmony XB6</b> .....                                | 1/2 to 1/4   |
| Ø 8 & 12, pilot lights, <b>Harmony XVL</b> .....                             | 1/5          |
| Ø 22, metal bezel, <b>Harmony XB4 / Control stations Harmony XAP</b> .....   | 1/6 to 1/9   |
| Ø 22, plastic bezel, <b>Harmony XB5 / Control stations Harmony XAL</b> ..... | 1/10 to 1/15 |
| Ø 22, plastic bezel - Monolithic, <b>Harmony XB7</b> .....                   | 1/16 to 1/17 |
| Ø 30, metal and plastic bezel, <b>Harmony 9001K, 9001SK</b> .....            | 1/18 to 1/20 |

### **Cam switches**

|                               |              |
|-------------------------------|--------------|
| <b>Harmony K series</b> ..... | 1/21 to 1/22 |
|-------------------------------|--------------|

### **Signalling solutions**

|  |      |
|--|------|
| Ø 40, 60, 100 mm monolithic tower lights, <b>Harmony XVC</b> .....                         | 1/23 |
| Ø 45 mm monolithic beacons and tower lights, accessories, <b>Harmony XVDLS / XVC</b> ..... | 1/24 |
| Ø 70 mm modular tower lights (IP 66), <b>Harmony XVB</b> .....                             | 1/25 |
| Ø 70 mm modular tower lights (up to IP 54), <b>Harmony XVE</b> .....                       | 1/26 |
| Ø 45, 50 mm modular tower lights (up to IP 54), <b>Harmony XVM / XVP</b> .....             | 1/27 |
| Modular tower lights accessories, <b>Harmony XV</b> .....                                  | 1/28 |
| Ø 84, 106, 120, 130 mm rotating mirror beacons, <b>Harmony XVR</b> .....                   | 1/29 |
| Accessories for rotating mirror beacons, <b>Harmony XVR</b> .....                          | 1/30 |
| Electronic alarms and multisound sirens, <b>Harmony XVS</b> .....                          | 1/30 |

### **Components for hoisting applications**

|  |              |
|--|--------------|
| Pendant control stations, <b>Harmony XAC</b> ..... | 1/31 to 1/32 |
|--|--------------|

## Human/Machine Interfaces

### **Display units, terminals, Industrial PCs**

|  |              |
|--|--------------|
| Small Panels, <b>Magelis STO/STU, XBT N / R / RT</b> ..... | 1/34 to 1/35 |
| Advanced Panels, <b>Magelis XBT GT, GK, GTW, GH</b> .....  | 1/36 to 1/39 |
| HMI Controllers, <b>Magelis XBT GC / GT / GK</b> .....     | 1/40 to 1/41 |
| PC BOX, <b>Magelis Box PC</b> .....                        | 1/42         |
| PC Panels, <b>Magelis Panel PC</b> .....                   | 1/43 to 1/45 |
| Industrial Display, <b>Magelis iDisplay</b> .....          | 1/43         |

### **Configuration software**

|   |              |
|---|--------------|
| For Magelis XBT N<br><b>Vijeo Designer Lite</b> .....   | 1/46 to 1/47 |
| For Magelis STO/STU, XBT GT, GK, GTW, GH, Magelis Box PC, Panel PC<br><b>Vijeo Designer</b> ..... | 1/46 to 1/47 |

## Dialog operator for Explosive atmospheres ..... 1/48 to 1/50

(1):

| Voltage                 | Letter (●) |
|-------------------------|------------|
| 12...24 V AC/DC (15 mA) | B          |
| 48...120 V AC (25 mA)   | G          |
| 230...240 V AC (25 mA)  | M          |



### Illuminated pushbuttons

|                             |                                   |  |
|-----------------------------|-----------------------------------|--|
| <b>Type of head</b>         |                                   | <b>Flush push</b>  |
| <b>Shape of head</b>        |                                   | rectangular (2)  |
| <b>Degree of protection</b> |                                   | IP 65 / Nema 4, 4X, 13 / Class II  |
| <b>Mounting (mm)</b>        | panel cut-out<br>mounting centres | $\varnothing 16.2^{+0.2}_0$<br>24 x 18 with rectangular head, 18 x 18 with square or circular head |
| <b>Dimensions (mm)</b>      | W x H x D (below head)            | 24 x 18 x 50 with rectangular head, 18 x 18 x 50 with square or circular head                      |
| <b>Connection (3)</b>       |                                   | Tags for 2.8 x 0.5 Faston connectors or for soldering  |

### Type of push

|  |  |   |
|--|--|---|
|  |  | <b>Spring return</b>                          |
|  |  | <b>Complete products</b><br>12 ... 24 V AC/DC |
|  |  | <b>Products for user assembly</b>             |
|  |  |   |

| References | Color  | Contact | Complete products | Products for user assembly | Products for user assembly | Products for user assembly |
|------------|--------|---------|-------------------|----------------------------|----------------------------|----------------------------|
|            | white  | NO      | XB6DW1B1B         | ZB6E●1B (1)                | ZB6Z1B                     | ZB6DW1                     |
|            |        | NO + NC | XB6DW1B5B         | ZB6E●1B (1)                | ZB6Z5B                     | ZB6DW1                     |
|            | green  | NO      | XB6DW3B1B         | ZB6E●3B (1)                | ZB6Z1B                     | ZB6DW3                     |
|            |        | NO + NC | XB6DW3B5B         | ZB6E●3B (1)                | ZB6Z5B                     | ZB6DW3                     |
|            | red    | NC      | XB6DW4B2B         | ZB6E●4B (1)                | ZB6Z2B                     | ZB6DW4                     |
|            |        | NO + NC | XB6DW4B5B         | ZB6E●4B (1)                | ZB6Z5B                     | ZB6DW4                     |
|            | yellow | NO      | –                 | ZB6E●5B (1)                | ZB6Z1B                     | ZB6DW5                     |
|            |        | NO + NC | XB6DW5B5B         | ZB6E●5B (1)                | ZB6Z5B                     | ZB6DW5                     |

### Type of push

|            |        |         |                 |             |        |        |
|------------|--------|---------|-----------------|-------------|--------|--------|
|            |        |         | <b>Latching</b> |             |        |        |
| References | white  | NO      | –               | ZB6E●1B (1) | ZB6Z1B | ZB6DF1 |
|            |        | NO + NC | XB6DF1B5B       | ZB6E●1B (1) | ZB6Z5B | ZB6DF1 |
|            | green  | NO      | XB6DF3B1B       | ZB6E●3B (1) | ZB6Z1B | ZB6DF3 |
|            |        | NO + NC | XB6DF3B5B       | ZB6E●3B (1) | ZB6Z5B | ZB6DF3 |
|            | red    | NC      | XB6DF4B2B       | ZB6E●4B (1) | ZB6Z2B | ZB6DF4 |
|            |        | NO + NC | XB6DF4B5B       | ZB6E●4B (1) | ZB6Z5B | ZB6DF4 |
|            | yellow | NO      | –               | ZB6E●5B (1) | ZB6Z1B | ZB6DF5 |
|            |        | NO + NC | –               | ZB6E●5B (1) | ZB6Z5B | ZB6DF5 |



### Pilot lights

|                      |  |                        |
|----------------------|--|------------------------|
| <b>Type of head</b>  |  | <b>Smooth lens cap</b> |
| <b>Shape of head</b> |  | rectangular (2)        |

|  |  |   |                                   |
|--|--|---|-----------------------------------|
|  |  | <b>Complete products</b><br>12 ... 24 V AC/DC | <b>Products for user assembly</b> |
|  |  |   |                                   |

| References | Color  | Contact | Complete products | Products for user assembly | Products for user assembly |
|------------|--------|---------|-------------------|----------------------------|----------------------------|
|            | white  | NO      | XB6DV1BB          | ZB6E●1B (1)                | ZB6DV1                     |
|            | green  | NO      | XB6DV3BB          | ZB6E●3B (1)                | ZB6DV3                     |
|            | red    | NO      | XB6DV4BB          | ZB6E●4B (1)                | ZB6DV4                     |
|            | yellow | NO      | XB6DV5BB          | ZB6E●5B (1)                | ZB6DV5                     |
|            | blue   | NO      | –                 | ZB6E●6B (1)                | ZB6DV6                     |

(1) Basic reference, to be completed by the letter B, G or M indicating the required voltage. See voltage table above.

(2) For products with a square head, replace the letter **D** in the reference by the letter **C** (XB6DW1B1B becomes XB6CW1B1B).

For products with a circular head, replace the letter **D** in the reference by the letter **A** (XB6DW1B1B becomes XB6AW1B1B).

(3) Alternative connection: 1 x 0.5 pins for printed circuit boards.













## Contact functions



1

### Pushbuttons

|                             |   |   |   |   |   |
|-----------------------------|---|---|---|---|---|
| <b>Type of head</b>         |    | <b>Flush push</b>   |   |   |   |
| <b>Shape of head</b>        |   | rectangular (1)   |   |   |   |
| <b>Degree of protection</b> |   | IP 65 / Nema 4, 4X, 13 / Class II   |   |   |   |
| <b>Mounting (mm)</b>        | panel cut-out<br>mounting centres   | $\varnothing 16.2^{+0.2}_0$   |   |   |   |
| <b>Dimensions (mm)</b>      | W x H x D (below head)  | 24 x 18 with rectangular head, 18 x 18 with square or circular head           |   |   |   |
| <b>Connection (2)</b>       |   | 24 x 18 x 50 with rectangular head, 18 x 18 x 50 with square or circular head |   |   |   |
| <b>Type of push</b>         |   | Tags for 2.8 x 0.5 Faston connectors or for soldering                         |   |   |   |
|                             |   | <b>Spring return</b>  |   |   |   |
|                             |   | <b>Complete products</b>  | <b>Products for user assembly</b>   |   |   |
|                             |   |   |  |  |  |
| <b>References</b>           | white    | NO  | <b>XB6DA11B</b>   | <b>ZB6Z1B</b>   | <b>ZB6DA1</b>   |
|                             |   | NO + NC   | <b>XB6DA15B</b>   | <b>ZB6Z5B</b>   | <b>ZB6DA1</b>   |
|                             | black    | NO  | –   | <b>ZB6Z1B</b>   | <b>ZB6DA2</b>   |
|                             |   | NO + NC   | <b>XB6DA25B</b>   | <b>ZB6Z5B</b>   | <b>ZB6DA2</b>   |
|                             | green   | NO  | <b>XB6DA31B</b>   | <b>ZB6Z2B</b>   | <b>ZB6DA3</b>   |
|                             |   | NO + NC   | <b>XB6DA35B</b>   | <b>ZB6Z5B</b>   | <b>ZB6DA3</b>   |
|                             | red    | NO  | –   | <b>ZB6Z1B</b>   | <b>ZB6DA4</b>   |
|                             |   | NO + NC   | <b>XB6DA45B</b>   | <b>ZB6Z5B</b>   | <b>ZB6DA4</b>   |





(1) For products with a square head, replace the letter **D** in the reference by the letter **C** (XB6DA11B becomes XB6CA11B).

For products with a circular head, replace the letter **D** in the reference by the letter **A** (XB6DA11B becomes XB6AA11B).

(2) Alternative connection: 1 x 0.5 pins for printed circuit boards.

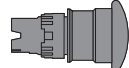

### Ø 30 mushroom head Emergency stop pushbuttons (3)

|                      |   |                                      |   |   |   |
|----------------------|---|--------------------------------------|---|---|---|
| <b>Type of head</b>  |      | <b>Trigger action (EN/ISO 13850)</b> |   |   |   |
| <b>Shape of head</b> |   | cylindrical                          |   |   |   |
| <b>Type of push</b>  |   | Turn to release                      |   |   |   |
|                      |   | <b>Complete products</b>             | <b>Products for user assembly</b>   |   |   |
|                      |   |                                      |  |  |  |
| <b>References</b>    | red  | 2 NC + 1 NO                          | <b>XB6AS8349B</b>   | <b>ZB6E2B</b>   | <b>ZB6Z5B</b>   |
| <b>Type of push</b>  |   | Key release, 200                     |   |   |   |
| <b>References</b>    | red  | 2 NC + 1 NO                          | <b>XB6AS9349B</b>   | <b>ZB6E2B</b>   | <b>ZB6Z5B</b>   |
|                      |   |                                      |   |   | <b>ZB6AS934</b>   |

(3) Emergency stop trigger action and mechanical latching pushbuttons conform to standards EN/IEC 60204-1 and EN/ISO 13850, to Machinery Directive 2006/42/EC and to standard EN/IEC 60947-5-5. Please consult your Regional Sales Office for a full explanation of these standards and directives.

1



### Selector switches and key switches

|                      |                                   |  |
|----------------------|-----------------------------------|--|
| Type of head         |                                   | Black handle   |
| Shape of head        |                                   | rectangular (2)  |
| Degree of protection |                                   | IP 66 / Nema 4, 4X, 13 / Class II  |
| Mounting (mm)        | panel cut-out<br>mounting centres | $\varnothing 16.2^{+0.2}_0$  |
| Dimensions (mm)      | W x H x D (below head)            | 24 x 18 with rectangular head, 18 x 18 with square or circular head  |
| Connection (3)       |                                   | 24 x 18 x 50 with rectangular head, 18 x 18 x 50 with square or circular head<br>Tags for 2.8 x 0.5 Faston connectors or for soldering |

| Type of operator             | Black handle  |  |  |
|------------------------------|---|--|--|
|                              | Complete products                                     | Products for user assembly             |  |
| Number and type of positions | 2 positions<br>stay put                               | 2 positions<br>stay put                | 2 positions<br>spring return to centre |
| References                   | NO<br><b>XB6DD221B</b><br>NO + NC<br><b>XB6DD225B</b> | ZB6Z1B<br>ZB6DD22<br>ZB6Z5B<br>ZB6DD22 | ZB6Z1B<br>ZB6DD24<br>ZB6Z5B<br>ZB6DD24 |
| Number and type of positions | 3 positions<br>stay put                               | 3 positions<br>stay put                | 3 positions<br>spring return to centre |
| References                   | NO<br><b>XB6DD235B</b>                                | ZB6Z5B<br>ZB6DD23                      | ZB6Z5B<br>ZB6DD25                      |



| Type of operator             | Key, n° 200                |                            |  |
|------------------------------|----------------------------|----------------------------|--|
|                              | Complete products          | Products for user assembly |  |
| Number and type of positions | 2 positions<br>stay put    | 2 positions<br>stay put    | 2 positions<br>spring return to centre |
| References                   | NO + NC<br><b>XB6DGC5B</b> | ZB6Z5B<br>ZB6DGC           | <b>ZB6Z5B</b><br><b>ZB6DGB</b>         |
| Number and type of positions | 3 positions<br>stay put    | 3 positions<br>stay put    | 3 positions<br>spring return to centre |
| References                   | NO + NC<br><b>XB6DGH5B</b> | ZB6Z5B<br>ZB6DGH           | ZB6Z5B<br>ZB6DGS                       |

(1):

| Voltage                 | Letter (●) |
|-------------------------|------------|
| 12...24 V AC/DC (15 mA) | B          |
| 48...120 V AC (25 mA)   | G          |
| 230...240 V AC (25 mA)  | M          |



### Illuminated selector switches

| Type of operator             | Coloured handle                                     |                         |                                 |
|------------------------------|---|-------------------------|---------------------------------|
|                              | Products for user assembly                          |                         |                                 |
| Number and type of positions |   | 2 positions<br>stay put | 3 positions<br>stay put         |
| References                   | white ● NO + NC<br><b>ZB6E●1B</b> (1) <b>ZB6Z5B</b> | <b>ZB6DD02</b>          | <b>ZB6DD03</b><br><b>ZB6YK1</b> |
|                              | green ● NO + NC<br><b>ZB6E●3B</b> (1) <b>ZB6Z5B</b> | <b>ZB6DD02</b>          | <b>ZB6DD03</b><br><b>ZB6YK3</b> |
|                              | red ● NO + NC<br><b>ZB6E●4B</b> (1) <b>ZB6Z5B</b>   | <b>ZB6DD02</b>          | <b>ZB6DD03</b><br><b>ZB6YK4</b> |

(1) Basic reference, to be completed by the letter B, G or M indicating the required voltage. See voltage table above.

(2) For products with a square head, replace the letter **D** in the reference by the letter **C** (XB6DD221B becomes XB6CD221B).

For products with a circular head, replace the letter **D** in the reference by the letter **A** (XB6DD221B becomes XB6AD221B).

(3) Alternative connection: 1 x 0.5 pins for printed circuit boards.

(1):

| Voltage      | Number (●) |
|--------------|------------|
| 5 V (25 mA)  | 1          |
| 12 V (18 mA) | 2          |
| 24 V (18 mA) | 3          |
| 48 V (10 mA) | 4          |



1

| LED pilot lights     |                        | With black bezel           |  | With integral lens cap   |  |
|----------------------|------------------------|----------------------------|--|--------------------------|--|
| Type of head         |                        | Protruding LED, Ø 8 mm     |  | Covered LED, Ø 8 mm      |  |
| Degree of protection |                        | IP 40, IP 65 with seal (2) |  |                          |  |
| Mounting (mm)        | panel cut-out          | Ø 8.2 mm                   |  | Ø 8.2 mm                 |  |
|                      | mounting centres       | 12.5 x 12.5 mm             |  | 10.5 x 10.5 mm           |  |
| Dimensions (mm)      | Ø x Depth (below head) | Ø 12 x 32                  |  | Ø 10 x 34                |  |
| Connection           |                        | Tags (3)                   |  | Threaded connectors      |  |
| References (1)       | green ●                | <b>XVLA1●3</b>             |  | <b>XVLA2●3</b>           |  |
|                      | red ●                  | <b>XVLA1●4</b>             |  | <b>XVLA2●4</b>           |  |
|                      | yellow ●               | <b>XVLA1●5</b>             |  | <b>XVLA2●5</b>           |  |
| Tightening key       |                        | For Ø 8 mm pilot lights    |  | For Ø 12 mm pilot lights |  |
| References           |                        | XVLX08                     |  | XVLX12                   |  |

(1) Basic reference, to be completed by the number 1, 2, 3 or 4 indicating the required voltage. See voltage table above.

(2) For an IP 65 degree of protection, include the seals: XVLZ911 for pilot lights XVLA1●● and XVLA2●●; XVLZ912 for pilot lights XVLA3●●.

(3) Tags for 2.8 x 0.5 Faston connectors or for soldering.

## Sub-assemblies & accessories for Ø 16 plastic bezel control and signalling units



| Sub-assemblies   |                       | Bodies for pushbuttons and selector switches |                          |                                | Bodies for pilot lights               |                 |              |                |  |
|--|-----------------------|--|--------------------------|--------------------------------|---------------------------------------|-----------------|--------------|----------------|--|
| Rated operational characteristics, AC-15: U <sub>e</sub> = 240 V and I <sub>e</sub> = 1.5 A or U <sub>e</sub> = 120 V and I <sub>e</sub> = 3 A |                       |  |                          |                                | Consumption                           |                 |              |                |  |
| Positive operation of contacts conforming to IEC/EN 60947-5-1: NC contacts with positive opening operation, positive opening force 20 N        |                       |  |                          |                                | 15 mA                                 | 12...24 V AC/DC |              |                |  |
|  |                       |  |                          |                                | 25 mA                                 | 48...120 V AC   |              |                |  |
|  |                       |  |                          |                                | 25 mA                                 | 230...240 V AC  |              |                |  |
|  |                       | Type of contact                              | Fixing collar + contacts | Contacts                       | Pilot light bodies                    | 12 ... 24 V     | 48 ... 120 V | 230 ... 240 V  |  |
| References   |                       | NO   | ZB6Z1B                   | <b>ZB6E1B</b>                  | White ●                               | <b>ZB6EB1B</b>  | ZB6EG1B      | <b>ZB6EM1B</b> |  |
|  |                       | NC   | ZB6Z2B                   | <b>ZB6E2B</b>                  | Green ●                               | <b>ZB6EB3B</b>  | ZB6EG3B      | <b>ZB6EM3B</b> |  |
|  |                       | 2 NO   | <b>ZB6Z3B</b>            | –                              | Red ●                                 | <b>ZB6EB4B</b>  | ZB6EG4B      | <b>ZB6EM4B</b> |  |
|  |                       | 2 NC   | ZB6Z4B                   | –                              | Yellow ●                              | <b>ZB6EB5B</b>  | ZB6EG5B      | <b>ZB6EM5B</b> |  |
|  |                       | NO + NC                                      | <b>ZB6Z5B</b>            | –                              | Blue ●                                | <b>ZB6EB6B</b>  | ZB6EG6B      | <b>ZB6EM6B</b> |  |
| Accessories  |                       |  |                          |                                |                                       |                 |              |                |  |
| Legend holders   |                       | 24 x 28 mm (8 x 21 mm legend)                |                          |                                | 24 x 36 mm (16 x 21 mm legend)        |                 |              |                |  |
| Blank legend   | Background colour     | without legend                               | yellow or white          | black or red                   | without legend                        | yellow or white | black or red |                |  |
| References (10)*   |                       | <b>ZB6YD20</b>                               | <b>ZB6YD21</b>           | ZB6YD22                        | ZB6YD30                               | ZB6YD31         | ZB6YD32      |                |  |
| Blank legends for legend holders   |                       | 8 x 21 mm (24 x 28 mm legend holder)         |                          |                                | 16 x 21 mm (24 x 36 mm legend holder) |                 |              |                |  |
|  | Background colour     | –  | yellow or white          | black or red                   | –                                     | yellow or white | black or red |                |  |
| References (20)*   |                       | –  | <b>ZB6Y1001</b>          | ZB6Y2001                       | –                                     | ZB6Y4001        | ZB6Y3001     |                |  |
| Ø 45 mm yellow legend for mushroom head Emergency stop pushbutton  |                       |  |                          |                                |                                       |                 |              |                |  |
|  | Marking               | Blank, for engraving                         |                          | EMERGENCY STOP                 | ARRET D'URGENCE                       |                 |              |                |  |
| References   |                       | <b>ZB6Y7001</b>                              |                          | <b>ZB6Y7330</b>                | <b>ZB6Y7130</b>                       |                 |              |                |  |
|  | Body/fixing collar    | Plate  |                          | Tightening tool                | Dismantling tool                      |                 |              |                |  |
|  |                       | anti-rotation                                |                          | and slackening, for fixing nut | for removal of contact blocks         |                 |              |                |  |
| References   | ZB6Y009 (10)*         | ZB6Y003 (10)*                                |                          | ZB6Y905 (2)*                   | ZB6Y018 (5)*                          |                 |              |                |  |
| Protective shutter for pushbuttons and switches  |                       |  |                          | Connector                      |                                       | Blanking plug   |              |                |  |
|  | for rectangular heads | for circular and square heads                |                          | Faston, female                 | IP 65                                 |                 |              |                |  |
| References   | ZB6YD001              | <b>ZB6YA001</b>                              |                          | ZB6Y004 (100)*                 | ZB6Y005 (10)*                         |                 |              |                |  |

\* sold in lots of

1



#### Pushbuttons, spring return

|                            |  |  |                   |                 |                                  |                    |                                  |                          |  |
|----------------------------|--|--|-------------------|-----------------|----------------------------------|--------------------|----------------------------------|--------------------------|--|
| <b>Type of head</b>        |  | <b>Chromium plated circular bezel</b>                  |                   |                 |                                  |                    |                                  |                          |  |
| Degree of protection       |  | IP 66 / Nema 4X, 13 / Class I                          |                   |                 |                                  |                    |                                  |                          |  |
| Mounting (mm)              |  | Ø 22.5 (22.4 <sup>+0.4</sup> <sub>0</sub> recommended) |                   |                 |                                  |                    |                                  |                          |  |
| Depth (mm)                 |  | 30 (horizontal) x 40 (vertical)                        |                   |                 |                                  |                    |                                  |                          |  |
| Connection (1)             |  | Screw clamp terminals                                  |                   |                 |                                  |                    |                                  |                          |  |
| <b>Type of push</b>        |  | <b>Flush</b>   |                   |                 | <b>Flush, booted</b>             |                    |                                  |                          |  |
| Unmarked                   |  | <b>Products</b>  |                   | <b>Complete</b> | <b>For user assembly</b>         |                    | <b>Complete</b>                  | <b>For user assembly</b> |  |
| References                 |  | black ● NO   | <b>XB4BA21</b>    | ZB4BZ101        | ZB4BA2                           | <b>XB4BP21</b>     | ZB4BZ101                         | ZB4BP2                   |  |
|                            |  | green ● NO   | <b>XB4BA31</b>    | ZB4BZ101        | ZB4BA3                           | <b>XB4BP31</b>     | ZB4BZ101                         | ZB4BP3                   |  |
|                            |  | red ● NC   | <b>XB4BA42</b>    | ZB4BZ102        | ZB4BA4                           | <b>XB4BP42</b>     | ZB4BZ102                         | ZB4BP4                   |  |
|                            |  | yellow ● NO  | <b>XB4BA51</b>    | ZB4BZ101        | ZB4BA5                           | <b>XB4BP51</b>     | ZB4BZ101                         | ZB4BP5                   |  |
|                            |  | blue ● NO  | <b>XB4BA61</b>    | ZB4BZ101        | ZB4BA6                           | <b>XB4BP61</b>     | ZB4BZ101                         | ZB4BP6                   |  |
| <b>Type of push</b>        |  | <b>Flush</b>   |                   |                 | <b>Mushroom head, Ø 40 mm</b>    |                    |                                  |                          |  |
| With international marking |  | <b>Products</b>  |                   | <b>Complete</b> | <b>For user assembly</b>         |                    |                                  |                          |  |
| References                 |  | green ⓘ NO   | <b>XB4BA3311</b>  | ZB4BZ101        | ZB4BA331                         | –                  | –                                | –                        |  |
|                            |  | red ⓘ NC   | <b>XB4BA4322</b>  | ZB4BZ102        | ZB4BA432                         | –                  | –                                | –                        |  |
|                            |  | white ⓘ NO   | <b>XB4BA3341</b>  | ZB4BZ101        | ZB4BA334                         | –                  | –                                | –                        |  |
|                            |  | black ⓘ NO   | <b>XB4BA3351</b>  | ZB4BZ101        | ZB4BA335                         | –                  | –                                | –                        |  |
| <b>Type of push</b>        |  | <b>Projecting</b>                                      |                   |                 | <b>Triple-headed pushbuttons</b> |                    | <b>Triple-headed pushbuttons</b> |                          |  |
| Unmarked                   |  | <b>Products</b>  |                   | <b>Complete</b> | <b>For user assembly</b>         |                    | <b>Complete</b>                  | <b>For user assembly</b> |  |
| References                 |  | black ● NO   | –                 | –               | –                                | <b>XB4BC21</b>     | ZB4BZ101                         | ZB4BC2                   |  |
|                            |  | red ● NC   | <b>XB4BL42</b>    | ZB4BZ102        | ZB4BL4                           | –                  | –                                | –                        |  |
| <b>Type of push</b>        |  | <b>Double-headed pushbuttons</b>                       |                   |                 | <b>Triple-headed pushbuttons</b> |                    | <b>Triple-headed pushbuttons</b> |                          |  |
| Degree of protection       |  | IP 66 - IP 69K   |                   |                 | IP 66 - IP 69K                   |                    | IP 66 - IP 69K                   |                          |  |
| With international marking |  | <b>Products</b>  |                   | <b>Complete</b> | <b>For user assembly</b>         |                    | <b>Complete</b>                  | <b>For user assembly</b> |  |
| References                 |  | (A) NO + NC  | <b>XB4BL73415</b> | ZB4BZ105        | ZB4BL7341                        | –                  | –                                | –                        |  |
|                            |  | (B) NO + NC + NO                                       | –                 | –               | –                                | <b>XB4BA711237</b> | ZB4BZ103 + ZBE102                | ZB4BA71123               |  |

(1) Alternative connections: plug-in connector, Faston connectors (6.35 and 2 x 2.8).



#### Ø 40 mm mushroom head Emergency stop pushbuttons (2)

|                     |  |                                      |                  |                          |                          |  |         |  |
|---------------------|--|--------------------------------------|------------------|--------------------------|--------------------------|--|---------|--|
| <b>Type of push</b> |  | <b>Trigger action (EN/ISO 13850)</b> |                  |                          |                          |  |         |  |
| Unmarked            |  | <b>Products</b>                      |                  | <b>Push-pull NO + NC</b> |                          |  |         |  |
| References          |  | red ● NO + NC                        | <b>XB4BT845</b>  | ZB4BZ105                 | <b>For user assembly</b> |  | ZB4BT84 |  |
| <b>Type of push</b> |  | <b>Turn to release NO + NC</b>       |                  |                          |                          |  |         |  |
| References          |  | red ● NO + NC                        | <b>XB4BS8445</b> | ZB4BZ105                 | ZB4BS844                 |  |         |  |
| <b>Type of push</b> |  | <b>Key release NO + NC</b>           |                  |                          |                          |  |         |  |
| References          |  | red ● NO + NC                        | <b>XB4BS9445</b> | ZB4BZ105                 | ZB4BS944                 |  |         |  |

(2) Emergency stop trigger action and mechanical latching pushbuttons conform to standards EN/IEC 60204-1 and EN/ISO 13850, to Machinery Directive 2006/42/EC and to standard EN/IEC 60947-5-5. Please consult your Regional Sales Office for a full explanation of these standards and directives.

## Contact functions



1

### Selector switches and key switches

|                              |                 |  |                             |  |  |
|------------------------------|-----------------|--|-----------------------------|--|--|
| <b>Type of head</b>          |                 | <b>Chromium plated circular bezel</b>                  |                             |  |  |
| Degree of protection         |                 | IP 66 / Nema 4X, 13 / Class I                          |                             |  |  |
| Mounting (mm)                |                 | Ø 22.5 (22.4 <sup>+0.4</sup> <sub>0</sub> recommended) |                             |  |  |
| Depth (mm)                   |                 | 30 (horizontal) x 40 (vertical)                        |                             |  |  |
| Connection (1)               |                 | Screw clamp terminals                                  |                             |  |  |
| <b>Type of operator</b>      |                 | <b>Handle</b>  |                             |  |  |
| <b>Products</b>              |                 | <b>Complete</b>  | <b>For user assembly</b>    | <b>Complete</b>                            | <b>For user assembly</b>                   |
|                              |                 |  |                             |  |  |
| Number and type of positions |                 | <b>2 positions</b> stay put                            | <b>2 positions</b> stay put | <b>2 positions</b> spring return to left   | <b>2 positions</b> spring return to left   |
| References                   | black ● NO      | <b>XB4BD21</b>   | ZB4BZ101   ZB4BD2           | <b>XB4BD41</b>                             | ZB4BZ101   ZB4BD4                          |
| Number and type of positions |                 | <b>3 positions</b> stay put                            | <b>3 positions</b> stay put | <b>3 positions</b> spring return to centre | <b>3 positions</b> spring return to centre |
| References                   | black ● NO + NO | <b>XB4BD33</b>   | ZB4BZ103   ZB4BD3           | <b>XB4BD53</b>                             | ZB4BZ103   ZB4BD5                          |



|                                  |                 |  |  |                             |                             |
|----------------------------------|-----------------|--|--|-----------------------------|-----------------------------|
| <b>Type of operator</b>          |                 | <b>Key, n° 455</b>                       |  |                             |                             |
| <b>Products</b>                  |                 | <b>Complete</b>                          | <b>For user assembly</b>                 | <b>Complete</b>             | <b>For user assembly</b>    |
|                                  |                 |  |  |                             |                             |
| Number and type of positions (2) |                 | <b>2 positions</b> stay put              | <b>2 positions</b> stay put              | <b>2 positions</b> stay put | <b>2 positions</b> stay put |
| References                       | black ● NO      | <b>XB4BG21</b>                           | ZB4BZ101   ZB4BG2                        | <b>XB4BG41</b>              | ZB4BZ101   ZB4BG4           |
| Number and type of positions     |                 | <b>2 positions</b> spring return to left | <b>2 positions</b> spring return to left | <b>3 positions</b> stay put | <b>3 positions</b> stay put |
| References                       | black ● NO      | <b>XB4BG61</b>                           | ZB4BZ101   ZB4BG6                        | -                           | -                           |
| References                       | black ● NO + NO | -  | -  | <b>XB4BG33</b>              | ZB4BZ103   ZB4BG3           |

1



#### Pilot lights

|                      |                                   |  |                |                |   |                              |
|----------------------|-----------------------------------|--|----------------|----------------|---|------------------------------|
| Type of head         |                                   | <b>Circular bezel</b><br><b>Smooth lens cap</b>        |                |                |   |                              |
| Degree of protection |                                   | IP 66 / Nema 4X, 13 / Class I                          |                |                |   |                              |
| Mounting (mm)        | panel cut-out<br>mounting centres | Ø 22.5 (22.4 <sup>+0.4</sup> <sub>0</sub> recommended) |                |                |   |                              |
| Depth                | below head                        | 30 (horizontal) x 40 (vertical)                        |                |                |   |                              |
| Connection (1)       |                                   | Screw clamp terminals                                  |                |                |   |                              |
| Light source         |                                   | Integral LED   |                |                | Direct supply for BA 9s bulb (not included) |                              |
|                      | <b>Products</b>                   | <b>Complete</b>  |                |                | <b>Complete</b>                             | <b>For user assembly</b><br> |
| Supply voltage       |                                   | 24 V AC/DC   | 110...120 V AC | 230...240 V AC | 250 V max., 2.4 W max.                      |                              |
| References           | white                             | <b>XB4BVB1</b>   | <b>XB4BVG1</b> | <b>XB4BVM1</b> | <b>XB4BV61</b>                              | ZB4BV6 ZB4BV01               |
|                      | green                             | <b>XB4BVB3</b>   | <b>XB4BVG3</b> | <b>XB4BVM3</b> | <b>XB4BV63</b>                              | ZB4BV6 ZB4BV03               |
|                      | red                               | <b>XB4BVB4</b>   | <b>XB4BVG4</b> | <b>XB4BVM4</b> | <b>XB4BV64</b>                              | ZB4BV6 ZB4BV04               |
|                      | yellow                            | <b>XB4BVB5</b>   | <b>XB4BVG5</b> | <b>XB4BVM5</b> | <b>XB4BV65</b>                              | ZB4BV6 ZB4BV05               |
|                      | blue                              | <b>XB4BVB6</b>   | <b>XB4BVG6</b> | <b>XB4BVM6</b> | –   | – –                          |



#### Illuminated pushbuttons and selector switches

|                |  |                  |                  |                  |   |                              |
|----------------|--|------------------|------------------|------------------|---|------------------------------|
| Type           | Flush push, spring return, illuminated pushbuttons |                  |                  |                  |   |                              |
| Light source   |  | Integral LED     |                  |                  | Direct supply for BA 9s bulb (not included) |                              |
|                | <b>Products</b>                                    | <b>Complete</b>  |                  |                  | <b>Complete</b>                             | <b>For user assembly</b><br> |
| Supply voltage |  | 24 V AC/DC       | 110...120 V AC   | 230...240 V AC   | 250 V max., 2.4 W max.                      |                              |
| References     | white  NO + NC                                     | <b>XB4BW31B5</b> | <b>XB4BW31G5</b> | <b>XB4BW31M5</b> | <b>XB4BW3165</b>                            | ZB4BW065 ZB4BW31             |
|                | green  NO + NC                                     | <b>XB4BW33B5</b> | <b>XB4BW33G5</b> | <b>XB4BW33M5</b> | <b>XB4BW3365</b>                            | ZB4BW065 ZB4BW33             |
|                | red  NO + NC                                       | <b>XB4BW34B5</b> | <b>XB4BW34G5</b> | <b>XB4BW34M5</b> | <b>XB4BW3465</b>                            | ZB4BW065 ZB4BW34             |
|                | orange  NO + NC                                    | <b>XB4BW35B5</b> | <b>XB4BW35G5</b> | <b>XB4BW35M5</b> | <b>XB4BW3565</b>                            | ZB4BW065 ZB4BW35             |
|                | blue  NO + NC                                      | <b>XB4BW36B5</b> | <b>XB4BW36G5</b> | <b>XB4BW36M5</b> | –   | – –                          |

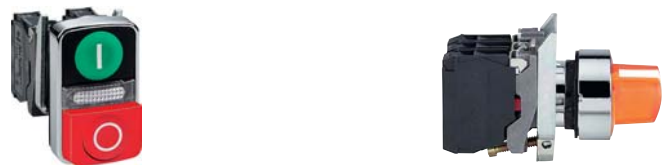

|                      |  |                     |                     |   |                   |                   |                   |
|----------------------|--|---------------------|---------------------|---|-------------------|-------------------|-------------------|
| Type                 | <b>Double-headed pushbuttons with LED pilot light</b><br>(1 flush green push, 1 projecting red push) |                     |                     | <b>Illuminated selector switches</b><br>(2 position stay put) |                   |                   |                   |
| Degree of protection | IP 66 - IP 69K   |                     |                     | IP 66   |                   |                   |                   |
| Light source         | Integral LED   |                     |                     | Integral LED  |                   |                   |                   |
|                      | <b>Products</b>  | <b>Complete</b>     |                     |   | <b>Complete</b>   |                   |                   |
| Supply voltage       |  | 24 V AC/DC          | 110...120 V AC      | 230...240 V AC  | 24 V AC/DC        | 110...120 V AC    | 230...240 V AC    |
| References           | green  NO + NC   | –                   | –                   | –   | <b>XB4BK123B5</b> | <b>XB4BK123G5</b> | <b>XB4BK123M5</b> |
|                      | red  NO + NC   | –                   | –                   | –   | <b>XB4BK124B5</b> | <b>XB4BK124G5</b> | <b>XB4BK124M5</b> |
|                      | orange  NO + NC  | –                   | –                   | –   | <b>XB4BK125B5</b> | <b>XB4BK125G5</b> | <b>XB4BK125M5</b> |
|                      | White  NO + NC   | <b>XB4BW73731B5</b> | <b>XB4BW73731G5</b> | <b>XB4BW73731M5</b>   | –                 | –                 | –                 |

(1) Alternative connections: plug-in connector, Faston connectors (6.35 and 2 x 2.8), spring clamp terminal.

## Separate components and accessories

1



### Electrical blocks (1) (2)

|   | Single contact blocks                       |                       | Light blocks with integral LED         |            |       |       | Light block, direct supply                              |                         |
|---|---|-----------------------|--|------------|-------|-------|---|-------------------------|
| Rated operational characteristics                             | AC-15, 240 V - 3 A                          |                       | Consumption                            |            |       |       |   |                         |
| Positive operation of contacts conforming to IEC/EN 60947-5-1 | NC contacts with positive opening operation |                       | 18 mA                                  | 24 V AC/DC |       |       |   |                         |
|   |   |                       | 14 mA                                  | 120 V AC   |       |       |   |                         |
| References (5)*   | Screw clamp terminal                        | Spring clamp terminal | To combine with heads for integral LED |            |       |       | For BA 9s bulb (not included)<br>250 V max., 2.4 W max. |                         |
|   | NC  | ZBE101                | ZBE1015                                | white      | ZBVB1 | ZBVG1 |   | ZBVM1                   |
|   | NO  | ZBE102                | ZBE1025                                | green      | ZBVB3 | ZBVG3 | ZBVM3   | Colour provided by lens |
|   |   |                       | red                                    | ZBVB4      | ZBVG4 | ZBVM4 |   |                         |
|   |   |                       | orange                                 | ZBVB5      | ZBVG5 | ZBVM5 |   |                         |
|   |   |                       | blue                                   | ZBVB6      | ZBVG6 | ZBVM6 |   |                         |



### Diecast metal enclosures

(Zinc alloy, usable depth 49 mm)

|                    | Front face dimensions | 1 vertical row |          |          |          | 2 vertical rows |          |          |
|--------------------|-----------------------|----------------|----------|----------|----------|-----------------|----------|----------|
|                    |                       | 1              | 2        | 3        | 4        | 2               | 4        | 6        |
| Number of cut-outs | 80 x 80 mm            | XAPM1201       | –        | –        | –        | XAPM1202        | –        | –        |
| References         | 80 x 130 mm           | –              | XAPM2202 | XAPM2203 | –        | –               | XAPM2204 | –        |
|                    | 80 x 175 mm           | –              | –        | XAPM3203 | XAPM3204 | –               | –        | XAPM3206 |

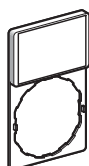
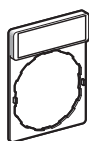

### Accessories (2)

#### Legend holders, 30 x 40 mm, for 8 x 27 mm legends

| References (10)* | Marking       | Background colour: black or red |         |               |         |        |         | white or yellow |         |   |
|------------------|---------------|---------------------------------|---------|---------------|---------|--------|---------|-----------------|---------|---|
|                  |               | Blank                           | ZBY2101 |               |         |        |         |                 | ZBY4101 |   |
|                  | International | 0 (red background)              | ZBY2931 | I             | ZBY2147 | AUTO   | ZBY2115 | STOP            | ZBY2304 | – |
|                  | English       | OFF                             | ZBY2312 | ON            | ZBY2311 | START  | ZBY2303 | –               | –       | – |
|                  | French        | ARRET (red b/grnd)              | ZBY2104 | ARRET-MARCHE  | ZBY2166 | MARCHE | ZBY2103 | –               | –       | – |
|                  | German        | AUS                             | ZBY2204 | AUS-EIN       | ZBY2266 | EIN    | ZBY2203 | –               | –       | – |
|                  | Spanish       | PARADA (red b/grnd)             | ZBY2404 | PARADA-MARCHA | ZBY2466 | MARCHA | ZBY2403 | –               | –       | – |

#### Legend holders, 30 x 50 mm, for 18 x 27 mm legends

| Background colour | black or red |         | white or yellow |
|-------------------|--------------|---------|-----------------|
| References (10)*  | Blank        | ZBY6101 | ZBY6102         |

#### Ø 60 mm legend for mushroom head Emergency stop pushbutton

| Background colour | yellow  |                |                 |          |                      |
|-------------------|---------|----------------|-----------------|----------|----------------------|
| Marking           | Blank   | EMERGENCY STOP | ARRET D'URGENCE | NOT HALT | PARADA DE EMERGENCIA |
| References        | ZBY9140 | ZBY9330        | ZBY9130         | ZBY9230  | ZBY9430              |

(1) Alternative connections: plug-in connector, Faston connectors (6.35 and 2 x 2.8), spring clamp terminal.

(2) Electrical blocks and accessories also for use with Harmony XB5plastic range

\* sold in lots of

1



### Pushbuttons, spring return

|                            |  |   |                   |                 |                                  |                    |                   |                          |  |
|----------------------------|--|---|-------------------|-----------------|----------------------------------|--------------------|-------------------|--------------------------|--|
| <b>Type of head</b>        |  | <b>Circular bezel</b>   |                   |                 |                                  |                    |                   |                          |  |
| Degree of protection       |  | IP 66 / Nema 4X, 13 / Class II  |                   |                 |                                  |                    |                   |                          |  |
| Mounting (mm)              |  | panel cut-out<br>mounting centres<br>Ø 22.5 (22.4 <sup>+0.4</sup> <sub>0</sub> recommended) |                   |                 |                                  |                    |                   |                          |  |
| Depth (mm)                 |  | 30 (horizontal) x 40 (vertical)   |                   |                 |                                  |                    |                   |                          |  |
| Connection (1)             |  | 43<br>Screw clamp terminals   |                   |                 |                                  |                    |                   |                          |  |
| <b>Type of push</b>        |  | <b>Flush</b>  |                   |                 | <b>Flush, booted</b>             |                    |                   |                          |  |
| Unmarked                   |  | <b>Products</b>   |                   | <b>Complete</b> | <b>For user assembly</b>         |                    | <b>Complete</b>   | <b>For user assembly</b> |  |
| References                 |  | black ● NO  | <b>XB5AA21</b>    | ZB5AZ101        | ZB5AA2                           | <b>XB5AP21</b>     | ZB5AZ101          | ZB5AP2                   |  |
|                            |  | green ● NO  | <b>XB5AA31</b>    | ZB5AZ101        | ZB5AA3                           | <b>XB5AP31</b>     | ZB5AZ101          | ZB5AP3                   |  |
|                            |  | red ● NC  | <b>XB5AA42</b>    | ZB5AZ102        | ZB5AA4                           | <b>XB5AP42</b>     | ZB5AZ102          | ZB5AP4                   |  |
|                            |  | yellow ● NO   | <b>XB5AA51</b>    | ZB5AZ101        | ZB5AA5                           | <b>XB5AP51</b>     | ZB5AZ101          | ZB5AP5                   |  |
|                            |  | blue ● NO   | <b>XB5AA61</b>    | ZB5AZ101        | ZB5AA6                           | <b>XB5AP61</b>     | ZB5AZ101          | ZB5AP6                   |  |
| <b>Type of push</b>        |  | <b>Flush</b>  |                   |                 | <b>Mushroom head, Ø 40 mm</b>    |                    |                   |                          |  |
| With international marking |  | <b>Products</b>   |                   | <b>Complete</b> | <b>For user assembly</b>         |                    | <b>Complete</b>   | <b>For user assembly</b> |  |
| References                 |  | green ⓘ NO  | <b>XB5AA3311</b>  | ZB5AZ101        | ZB5AA331                         | –                  | –                 | –                        |  |
|                            |  | red ⓘ NC  | <b>XB5AA4322</b>  | ZB5AZ102        | ZB5AA432                         | –                  | –                 | –                        |  |
|                            |  | white ⓘ NO  | <b>XB5AA3341</b>  | ZB5AZ101        | ZB5AA334                         | –                  | –                 | –                        |  |
|                            |  | black ⓘ NO  | <b>XB5AA3351</b>  | ZB5AZ101        | ZB5AA335                         | –                  | –                 | –                        |  |
| <b>Type of push</b>        |  | <b>Projecting</b>   |                   |                 | <b>Triple-headed pushbuttons</b> |                    |                   |                          |  |
| Unmarked                   |  | <b>Products</b>   |                   | <b>Complete</b> | <b>For user assembly</b>         |                    | <b>Complete</b>   | <b>For user assembly</b> |  |
| References                 |  | black ● NO  | –                 | –               | –                                | <b>XB5AC21</b>     | ZB5AZ101          | ZB5AC2                   |  |
|                            |  | red ● NC  | <b>XB5AL42</b>    | ZB5AZ102        | ZB5AL4                           | –                  | –                 | –                        |  |
| <b>Type of push</b>        |  | <b>Double-headed pushbuttons</b>  |                   |                 | <b>Triple-headed pushbuttons</b> |                    |                   |                          |  |
| Degree of protection       |  | IP 66 - IP 69K  |                   |                 | IP 66 - IP 69K                   |                    |                   |                          |  |
| With international marking |  | <b>Products</b>   |                   | <b>Complete</b> | <b>For user assembly</b>         |                    | <b>Complete</b>   | <b>For user assembly</b> |  |
| References                 |  | (A) NO + NC   | <b>XB5AL73415</b> | ZB5AZ105        | ZB5AL7341                        | –                  | –                 | –                        |  |
|                            |  | (B) NO + NC + NO  | –                 | –               | –                                | <b>XB5AA711237</b> | ZB5AZ103 + ZBE102 | ZB5AA71123               |  |

(1) Alternative connections: plug-in connector, Faston connectors (6.35 and 2 x 2.8).



### Ø 40 mm mushroom head Emergency stop pushbuttons (2)

|                     |  |                                      |                  |                 |                            |   |                 |                          |  |
|---------------------|--|--------------------------------------|------------------|-----------------|----------------------------|---|-----------------|--------------------------|--|
| <b>Type of push</b> |  | <b>Trigger action (EN/ISO 13850)</b> |                  |                 |                            |   |                 |                          |  |
| Unmarked            |  | <b>Products</b>                      |                  | <b>Complete</b> | <b>For user assembly</b>   |   | <b>Complete</b> | <b>For user assembly</b> |  |
| References          |  | red ● NO + NC                        | <b>XB5AT845</b>  | ZB5AZ105        | ZB5AT84                    | – | –               | –                        |  |
| <b>Type of push</b> |  | <b>Turn to release NO + NC</b>       |                  |                 | <b>Key release NO + NC</b> |   |                 |                          |  |
| References          |  | red ● NO + NC                        | <b>XB5AS8445</b> | ZB5AZ105        | ZB5AS844                   | – | –               | –                        |  |
| References          |  | red ● NO + NC                        | <b>XB5AS9445</b> | ZB5AZ105        | ZB5AS944                   | – | –               | –                        |  |

(2) Emergency stop trigger action and mechanical latching pushbuttons conform to standards EN/IEC 60204-1 and EN/ISO 13850: to Machinery Directive 2006/42/EC and to standard EN/IEC 60947-5-5. Please consult your Regional Sales Office for a full explanation of these standards and directives.



## Contact functions



1

### Selector switches and key switches

|                                  |                 |  |                          |  |  |
|----------------------------------|-----------------|--|--------------------------|--|--|
| <b>Type of head</b>              |                 | <b>Circular bezel</b>                                  |                          |  |  |
| Degree of protection             |                 | IP 66 / Nema 4X, 13 / Class II                         |                          |  |  |
| Mounting (mm)                    |                 | Ø 22.5 (22.4 <sup>+0.4</sup> <sub>0</sub> recommended) |                          |  |  |
| Depth (mm)                       |                 | 30 (horizontal) x 40 (vertical)                        |                          |  |  |
| Connection (1)                   |                 | Screw clamp terminals                                  |                          |  |  |
| <b>Type of operator</b>          |                 | <b>Handle</b>  |                          |  |  |
| <b>Products</b>                  |                 | <b>Complete</b>  | <b>For user assembly</b> | <b>Complete</b>                        | <b>For user assembly</b>               |
| Number and type of positions     |                 | 2 positions<br>stay put                                | 2 positions<br>stay put  | 2 positions<br>spring return to left   | 2 positions<br>spring return to left   |
| References                       | black ● NO      | <b>XB5AD21</b>   | ZB5AZ101   ZB5AD2        | <b>XB5AD41</b>                         | ZB5AZ101   ZB5AD4                      |
| Number and type of positions     |                 | 3 positions<br>stay put                                | 3 positions<br>stay put  | 3 positions<br>spring return to centre | 3 positions<br>spring return to centre |
| References                       | black ● NO + NO | <b>XB5AD33</b>   | ZB5AZ103   ZB5AD3        | <b>XB5AD53</b>                         | ZB5AZ103   ZB5AD5                      |
| <b>Type of operator</b>          |                 | <b>Key, n° 455</b>                                     |                          |  |  |
| Number and type of positions (2) |                 | 2 positions<br>stay put                                | 2 positions<br>stay put  | 2 positions<br>stay put                | 2 positions<br>stay put                |
| References                       | black ● NO      | <b>XB5AG21</b>   | ZB5AZ101   ZB5AG2        | <b>XB5AG41</b>                         | ZB5AZ101   ZB5AG4                      |

(2) The symbol  indicates key withdrawal position.

1



| Ready to use packs  | Panel mounting            |                 |                                     |                 | Mobile application        |                                     |
|---|---------------------------|-----------------|-------------------------------------|-----------------|---------------------------|-------------------------------------|
| Wireless and batteryless 22mm pushbutton assembled on fixing collar | Plastic head              | Metal head      | Plastic head                        | Metal head      | Plastic head in handy box |                                     |
| Caps  | 1 black cap               |                 | 1 set of 10 different coloured caps |                 | 1 black cap               | 1 set of 10 different coloured caps |
| Receiver  | Non programmable receiver |                 | Programmable receiver               |                 | Non programmable receiver | Programmable receiver               |
| Relay output  | 1relay output type RT 3A  |                 | 2 relays output type RT 3A          |                 | 1relay output type RT 3A  | 2 relays output type RT 3A          |
| Voltage receiver  | 24 VDC                    |                 | 24...240 AC/DC                      |                 | 24 VDC                    | 24...240 AC/DC                      |
| References  | <b>XB5RFB01</b>           | <b>XB4RFB01</b> | <b>XB5RFA02</b>                     | <b>XB4RFA02</b> | <b>XB5RMB03</b>           | <b>XB5RMA04</b>                     |

The pushbutton and receiver are factory paired



| Transmitter components for wireless and batteryless pushbuttons |            |                             | Transmitter for wireless and batteryless pushbuttons   | Plastic head     | Metal head       |
|---|------------|-----------------------------|--|------------------|------------------|
| Wireless and batteryless pushbuttons including                  |            |                             | - a transmitter fitted with fixing collar<br>- a spring return pushbutton head with clipped-in cap |                  |                  |
| Reference   | Cap colour | White                       | <b>ZBRT1</b>   | -                | -                |
|   |            | Black                       | -  | <b>ZB5RTA1</b>   | <b>ZB4RTA1</b>   |
|   |            | Green                       | -  | <b>ZB5RTA2</b>   | <b>ZB4RTA2</b>   |
|   |            | White I on green background | -  | <b>ZB5RTA3</b>   | <b>ZB4RTA3</b>   |
|   |            | Red                         | -  | <b>ZB5RTA331</b> | <b>ZB4RTA331</b> |
|   |            | White O on red background   | -  | <b>ZB5RTA4</b>   | <b>ZB4RTA4</b>   |
|   |            | Yellow                      | -  | <b>ZB5RTA432</b> | <b>ZB4RTA432</b> |
|   |            | Blue                        | -  | <b>ZB5RTA5</b>   | <b>ZB4RTA5</b>   |
|   |            | -                           | -  | <b>ZB5RTA6</b>   | <b>ZB4RTA6</b>   |



**Programmable receivers**

|                                      |  |                            |
|--------------------------------------|--|----------------------------|
| Programmable receivers equipped with | - 2 buttons (learn, parameter setting)<br>- 6 indicating LEDs (power ON, outputs, signal strength) |                            |
| Output type                          | 4 PNP outputs 200 mA / 24V   | 2 relay outputs type RT 3A |
| Receiver voltage                     | 24 VDC   | 24...240 AC/DC             |
| References                           | ZBRR C   | ZBRR A                     |



**Relay antenna**

|  |   |  |
|--|---|--|
| The relay antenna is placed between transmitter and receiver | Used to increase the distance and/or get round obstacles<br>- 5m cable<br>- 1 power-ON LED<br>- 2 LEDs reception / transmission<br>- Relay antenna voltage : 24...240 AC/DC |  |
| Reference  | ZBRA1   |  |









|             |   |   |        |            |
|-------------|---|---|--------|------------|
| Empty boxes | <b>Handy box, plastic, empty</b><br>1 cut-out | <b>Empty plastic boxes</b><br>1 cut-out |        | 2 cut-outs |
| References  | ZBRM01  | XALD01                                  | XALD02 | XALD02     |

1







### Pilot lights





|                      |   |  |                |                |   |                   |         |
|----------------------|---|--|----------------|----------------|---|-------------------|---------|
| Type of head         |          | Circular bezel<br>Smooth lens cap                      |                |                |   |                   |         |
| Degree of protection |   | IP 66 / Nema 4X, 13 / Class II                         |                |                |   |                   |         |
| Mounting (mm)        | panel cut-out   | Ø 22.5 (22.4 <sup>+0.4</sup> <sub>0</sub> recommended) |                |                |   |                   |         |
|                      | mounting centres  | 30 (horizontal) x 40 (vertical)                        |                |                |   |                   |         |
| Depth                | below head  | 43   |                |                |   |                   |         |
| Connection (1)       |   | Screw clamp terminals                                  |                |                |   |                   |         |
| Light source         |   | Integral LED   |                |                | Direct supply for BA 9s bulb (not included) |                   |         |
|                      | Products  | Complete   |                |                | Complete                                    | For user assembly |         |
| Supply voltage       |   | 24 V AC/DC   | 110...120 V AC | 230...240 V AC | 250 V max., 2.4 W max.                      |                   |         |
| References           | white    | <b>XB5AVB1</b>   | <b>XB5AVG1</b> | <b>XB5AVM1</b> | <b>XB5AV61</b>                              | ZB5AV6            | ZB5AV01 |
|                      | green    | <b>XB5AVB3</b>   | <b>XB5AVG3</b> | <b>XB5AVM3</b> | <b>XB5AV63</b>                              | ZB5AV6            | ZB5AV03 |
|                      | red      | <b>XB5AVB4</b>   | <b>XB5AVG4</b> | <b>XB5AVM4</b> | <b>XB5AV64</b>                              | ZB5AV6            | ZB5AV04 |
|                      | orange  | <b>XB5AVB5</b>   | <b>XB5AVG5</b> | <b>XB5AVM5</b> | <b>XB5AV65</b>                              | ZB5AV6            | ZB5AV05 |
|                      | blue   | <b>XB5AVB6</b>   | <b>XB5AVG6</b> | <b>XB5AVM6</b> | –   | –                 | –       |
|                      |   |  |                |                |   |                   |         |



### Illuminated pushbuttons and selector switches

|                |  |                  |                  |                  |   |                   |         |
|----------------|--|------------------|------------------|------------------|---|-------------------|---------|
| Type           | Flush push, spring return, illuminated pushbuttons   |                  |                  |                  |   |                   |         |
| Light source   |  | Integral LED     |                  |                  | Direct supply for BA 9s bulb (not included) |                   |         |
|                | Products   | Complete         |                  |                  | Complete                                    | For user assembly |         |
| Supply voltage |  | 24 V AC/DC       | 110...120 V AC   | 230...240 V AC   | 250 V max., 2.4 W max.                      |                   |         |
| References     | white  NO + NC  | <b>XB5AW31B5</b> | <b>XB5AW31G5</b> | <b>XB5AW31M5</b> | <b>XB5AW3165</b>                            | ZB5AW065          | ZB5AW31 |
|                | green  NO + NC  | <b>XB5AW33B5</b> | <b>XB5AW33G5</b> | <b>XB5AW33M5</b> | <b>XB5AW3365</b>                            | ZB5AW065          | ZB5AW33 |
|                | red  NO + NC    | <b>XB5AW34B5</b> | <b>XB5AW34G5</b> | <b>XB5AW34M5</b> | <b>XB5AW3465</b>                            | ZB5AW065          | ZB5AW34 |
|                | orange  NO + NC | <b>XB5AW35B5</b> | <b>XB5AW35G5</b> | <b>XB5AW35M5</b> | <b>XB5AW3565</b>                            | ZB5AW065          | ZB5AW35 |
|                | blue  NO + NC   | <b>XB5AW36B5</b> | <b>XB5AW36G5</b> | <b>XB5AW36M5</b> | –   | –                 | –       |
|                |  |                  |                  |                  |   |                   |         |



|                      |  |                     |                     |  |                   |                   |                   |
|----------------------|--|---------------------|---------------------|--|-------------------|-------------------|-------------------|
| Type                 | Double-headed pushbuttons with LED pilot light<br>(1 flush green push, 1 projecting red push)      |                     |                     | Illuminated selector switches<br>(2 position stay put) |                   |                   |                   |
| Degree of protection | IP 66 - IP 69K   |                     |                     | IP 66  |                   |                   |                   |
| Light source         |  | Integral LED        |                     |  | Integral LED      |                   |                   |
|                      | Products   | Complete            |                     |  | Complete          |                   |                   |
| Supply voltage       |  | 24 V AC/DC          | 110...120 V AC      | 230...240 V AC   | 24 V AC/DC        | 110...120 V AC    | 230...240 V AC    |
| References           | green  NO + NC  | –                   | –                   | –  | <b>XB5AK123B5</b> | <b>XB5AK123G5</b> | <b>XB5AK123M5</b> |
|                      | red  NO + NC    | –                   | –                   | –  | <b>XB5AK124B5</b> | <b>XB5AK124G5</b> | <b>XB5AK124M5</b> |
|                      | orange  NO + NC | –                   | –                   | –  | <b>XB5AK125B5</b> | <b>XB5AK125G5</b> | <b>XB5AK125M5</b> |
|                      | white  NO + NC  | <b>XB5AW73731B5</b> | <b>XB5AW73731G5</b> | <b>XB5AW73731M5</b>                                    | –                 | –                 | –                 |
|                      |  |                     |                     |  |                   |                   |                   |

(1) Alternative connections: plug-in connector, Faston connectors (6.35 and 2 x 2.8), spring clamp terminal.

Separate components and accessories: see previous page.

(1):

| Number of cut-outs | Number (●) |
|--------------------|------------|
| 1                  | 1          |
| 2                  | 2          |
| 3                  | 3          |
| 4                  | 4          |
| 5                  | 5          |



### Complete stations with 1 pushbutton, selector switch or key switch (light grey RAL 7035 base with dark grey RAL 7016 lid)

|   |    |                                   |                 |                      |   |                                     |         |
|---|----|-----------------------------------|-----------------|----------------------|---|-------------------------------------|---------|
| <b>Degree of protection</b>                                     |    | IP 65 / Nema 4X and 13 / Class II |                 |                      |   |                                     |         |
| <b>Dimensions (mm)</b>  |    | W x H x D                         |                 |                      |   |                                     |         |
| <b>Fixing (mm)</b>  |    | 2 x Ø 4.3 on 54 mm centres        |                 |                      |   |                                     |         |
| <b>Function</b>   |    | <b>1 Start or Stop function</b>   |                 |                      | <b>1 Start-Stop function</b>                        |                                     |         |
| <b>Marking</b>  |    | On spring return push             |                 |                      | On legend holder and legend below head              |                                     |         |
| <b>Number and type of pushbutton/selector switch/key switch</b> |    | 1 flush green p/b                 | 1 flush red p/b | 1 projecting red p/b | 1 2 position stay put selector switch or key switch |                                     |         |
|   |    |                                   |                 |                      | Black handle  | Key n° 455 (key withdrawal LH pos.) |         |
| <b>References</b>   | NO | I                                 | XALD102         | –                    | –   | –                                   |         |
|   |    | Start                             | XALD103         | –                    | –   | –                                   | –       |
|   |    | O - I                             | –               | –                    | –   | XALD134                             | XALD144 |
|   |    | O                                 | –               | XALD112              | XALD115   | –                                   | –       |

(1) Empty enclosures:

Basic reference: XALK0●, replace the ● by the number of cut-outs required (see cut-out table above)



|  |              |   |  |                               |  |
|--|--------------|---|--|-------------------------------|--|
| <b>Function</b>                                    |              | <b>Emergency stop (2)</b> (light grey RAL 7035 base with yellow RAL 1012 lid) |  |                               |  |
| <b>Number and type of mushroom head pushbutton</b> |              | 1 red Ø 40 head, turn to release  |  | 1 red Ø 40 head, key release  |  |
| <b>Latching mechanism</b>                          |              | Trigger action (EN/ISO 13850)   |  | Trigger action (EN/ISO 13850) |  |
| <b>References</b>                                  | NC           | XALK178   |  | XALK188                       |  |
|  | NC + NC      | XALK178F  |  | XALK188F                      |  |
|  | NO + NC      | XALK178E  |  | XALK188E                      |  |
|  | NC + NC + NO | XALK178G  |  | XALK188G                      |  |

(2) Emergency stop trigger action and mechanical latching pushbuttons conform to standards EN/IEC 60204-1 and EN/ISO 13850, to Machinery Directive 2006/42/EC and to standard EN/IEC 60947-5-5. Please consult your Regional Sales Office for a full explanation of these standards and directives.



(1) Empty enclosures:

Basic reference: XALD0●, replace the ● by the number of cut-outs required (see cut-out table above)

### Complete stations with 2 and 3 pushbuttons or 2 pushbuttons + 1 pilot light (light grey RAL 7035 base with dark grey RAL 7016 lid)

|  |         |  |                                     |                        |                      |                   |                              |                   |
|--|---------|--|-------------------------------------|------------------------|----------------------|-------------------|------------------------------|-------------------|
| <b>Dimensions (mm)</b>                           |         | W x H x D  |                                     |                        |                      |                   |                              |                   |
| <b>Fixing (mm)</b>                               |         | 2-way control stations: 68 x 106 x 62; 3-way control stations: 68 x 136 x 87 |                                     |                        |                      |                   |                              |                   |
| <b>Function</b>                                  |         | <b>Start-Stop functions</b>  |                                     |                        | <b>2 functions</b>   |                   | <b>3 functions</b>           |                   |
| <b>Marking</b>                                   |         | On spring return push  |                                     |                        |                      |                   |                              |                   |
| <b>Number and type of pushbutton/pilot light</b> |         | 1 flush green p/b  | 1 flush green pushbutton            | 1 flush white p/b      | 1 flush white p/b    | 1 flush white p/b | 1 flush white p/b            | 1 flush white p/b |
|  |         | 1 flush red p/b  | 1 flush red pushbutton              | 1 flush black p/b      | 1 flush red p/b      | 1 flush red p/b   | 1 Ø 30 red mushroom head p/b | 1 flush black p/b |
|  |         |  | 1 red pilot light with integral LED |                        |                      |                   |                              | 1 flush black p/b |
| <b>References</b>                                | NO + NC | I - O  | XALD213                             | 24 V AC/DC<br>XALD363B | 230 V AC<br>XALD363M | –                 | –                            | –                 |
|  |         | Start - Stop   | XALD215                             | –                      | –                    | –                 | –                            | –                 |
|  |         | NO + NO  | ↕                                   | –                      | –                    | –                 | XALD222                      | –                 |
|  |         | NO + NC + NO   | ↕                                   | –                      | –                    | –                 | –                            | XALD324           |

| Accessories | Standard contact blocks |            | Light blocks with integral LED, colour red |          |
|-------------|-------------------------|------------|--|----------|
| Description | NO contact              | NC contact | 24 V AC/DC                                 | 230 V AC |
| References  | ZENL111                 | ZENL121    | ZALVB4                                     | ZALVM4   |

1







#### Pushbuttons

|                      |   |  |                                 |                                  |
|----------------------|---|--|---------------------------------|----------------------------------|
| Type of head         |  | <b>Flush or projecting push</b>  |                                 |                                  |
| Degree of protection |   | circular   |                                 |                                  |
| Degree of protection |   | IP 65, class II  |                                 |                                  |
| Mounting (mm)        | panel cut-out   | Ø 22.4 (0 +0.1)  |                                 |                                  |
| Mounting (mm)        | mounting centres  | 30 (horizontal) x 40 (vertical)  |                                 |                                  |
| Dimensions (mm)      | Ø x Depth (below head)  | Ø 29 x 41.5 (Ø 40 x 41.5 for Emergency stop)                               |                                 |                                  |
| Connection           |   | Screw clamp terminals, 1 x 0.34 mm <sup>2</sup> to 1 x 1.5 mm <sup>2</sup> |                                 |                                  |
| <b>Type of push</b>  |   | <b>Flush, spring return</b>  | <b>Flush, push and latching</b> |                                  |
| References (10)*     | white   | NO   | XB7NA11                         | –                                |
|                      |   | NO + NC  | XB7NA15                         | –                                |
|                      | black   | NO   | <b>XB7NA21</b>                  | XB7NH21                          |
|                      |   | NO + NC  | <b>XB7NA25</b>                  | XB7NH25                          |
|                      | green   | NO   | <b>XB7NA31</b>                  | <b>XB7NH31</b>                   |
|                      |   | NO + NC  | <b>XB7NA35</b>                  | XB7NH35                          |
|                      | red   | NC   | <b>XB7NA42</b>                  | –                                |
|                      |   | NO + NC  | <b>XB7NA45</b>                  | –                                |
|                      | yellow  | NO   | XB7NA81                         | –                                |
|                      | <b>Type of push</b>   |  | <b>Flush, spring return</b>     | <b>Projecting, spring return</b> |
| References           | green   | NO   | <b>XB7NA3131</b>                | –                                |
|                      | red   | NC   | –                               | <b>XB7NL4232</b>                 |
|                      | white   | NO   | <b>XB7NA11341</b>               | –                                |
|                      | black   | NO   | <b>XB7NA21341</b>               | –                                |
|                      |   | NO + NC  | <b>XB7NA25341</b>               | –                                |



#### Selector switches and key switches

|                              |         |   |   |   |   |
|------------------------------|---------|---|---|---|---|
| Type of operator             |         | <b>Black handle</b>   |   | <b>Key, n° 455</b>  |   |
| Number and type of positions |         | <b>2 positions</b> stay put  | <b>3 positions</b> stay put  | <b>2 positions</b> stay put  | <b>3 positions</b> stay put  |
| References (10*)             | NO      | <b>XB7ND21</b>  | –   | <b>XB7NG21</b>  | –   |
|                              | NO + NC | XB7ND25   | –   | –   | –   |
|                              | 2 NO    | –   | <b>XB7ND33</b>  | –   | XB7NG33   |



#### Ø 40mm Emergency Stop trigger action and mechanical latching pushbuttons

|              |     |                 |            |                      |
|--------------|-----|-----------------|------------|----------------------|
| Type of push |     | Turn to release | Push, Pull | Key release (n° 455) |
| References*  | red | NC              | XB7 NS8442 | –                    |
|              | red | NO + NC         | XB7 NS8445 | XB7 NS9445           |
|              | red | 2NC             | XB7 NS8444 | XB7 NS9444           |

\* sold in lots of 10

## Contact functions and light functions

(1):

| Supply voltage for integral LED light source only | Letter (●) |
|---|------------|
| 24 V AC/DC  | B          |
| 120 V AC  | G          |
| 230 V AC  | M          |



### Illuminated pushbuttons

| Type of head                      |        | Projecting push  |   |
|-----------------------------------|--------|--|---|
|                                   |        | circular   |   |
| Degree of protection              |        | IP 65, class II  |   |
| Mounting (mm)                     |        | Ø 22.4 (0 +0.1)  |   |
| panel cut-out<br>mounting centres |        | 30 (horizontal) x 40 (vertical)  |   |
| Dimensions (mm)                   |        | Ø 29 x 41.5, (Ø 40 x 41.5 for Emergency stop)                              |   |
| Connection                        |        | Screw clamp terminals, 1 x 0.34 mm <sup>2</sup> to 1 x 1.5 mm <sup>2</sup> |   |
| Light source                      |        | Integral LED   | BA 9s base fitting Incandescent bulb<br>direct supply (bulb not included) |
| Type of push                      |        | Spring return  |   |
| References (10)*                  | green  | NO   | <b>XB7NW33●1</b> (1) <b>XB7NW3361</b>                                     |
|                                   | red    | NO   | <b>XB7NW34●1</b> (1) <b>XB7NW3461</b>                                     |
|                                   |        | NC   | <b>XB7NW34●2</b> (1) –  |
|                                   | orange | NO   | <b>XB7NW35●1</b> (1) –  |
|                                   | blue   | NO   | <b>XB7NW36●1</b> (1) –  |
|                                   | clear  | NO   | <b>XB7NW37●1</b> (1) –  |
|                                   | yellow | NO   | <b>XB7NW38●1</b> (1) <b>XB7NW3561</b>                                     |
| Type of push                      |        | Push and latching  |   |
| References (10)*                  | green  | NO   | <b>XB7NH03●1</b> (1) <b>XB7NH0361</b>                                     |
|                                   | red    | NO   | <b>XB7NH04●1</b> (1) <b>XB7NH0461</b>                                     |
|                                   |        | NC   | <b>XB7NH04●2</b> (1) –  |
|                                   | yellow | NO   | <b>XB7NH08●1</b> (1) <b>XB7NH0861</b>                                     |



### Pilot lights (2)

| Light source     | Integral LED                       | Ba 9s base fitting incandescent bulb<br>direct supply<br>(bulb not included) | Incandescent bulb<br>direct through resistor<br>(bulb included) |
|------------------|------------------------------------|--|---|
| Supply voltage   | 24VAC/DC or 120VAC or 230...240VAC | 6 or 24 V DC, or 130 V AC  | 230 V AC  |
| References (10)* | clear                              | <b>XB7EV07●P</b> (1)   | <b>XB7EV67P</b> <b>XB7EV77P</b>                                 |
|                  | green                              | <b>XB7EV03●P</b> (1)   | <b>XB7EV63P</b> <b>XB7EV73P</b>                                 |
|                  | red                                | <b>XB7EV04●P</b> (1)   | <b>XB7EV64P</b> <b>XB7EV74P</b>                                 |
|                  | yellow                             | <b>XB7EV05●P</b> (1)   | <b>XB7EV65P</b> <b>XB7EV75P</b>                                 |
|                  | blue                               | <b>XB7EV06●P</b> (1)   | <b>XB7EV66P</b> <b>XB7EV76P</b>                                 |
|                  | orange                             | <b>XB7EV08●P</b> (1)   | <b>XB7EV68P</b> <b>XB7EV78P</b>                                 |

### Incandescent bulbs, long life

BA 9s base fitting, Ø 11 mm max., length 28 mm max.

| References | 6 V (1.2 W) | 24 V (2 W) | 130 V (2.4 W) |
|------------|-------------|------------|---------------|
|            | DL1CB006    | DL1CE024   | DL1CE130      |

(1) Basic reference, to be completed by the letter B, G or M indicating the required voltage. See voltage table above.

(2) Alternative connection: 1 x 6.35 and 2 x 2.8 mm Faston connectors.

\* sold in lots of 10

1



#### Pushbuttons, spring return

|                              |                                   |  |                    |                         |
|------------------------------|-----------------------------------|--|--------------------|-------------------------|
| <b>Type of push</b>          |                                   | Flush  | Projecting         | Projecting (high guard) |
| <b>Colour of push</b>        |                                   | Multi-colour (set of 7 clip-in coloured caps)                            |                    |                         |
| <b>Degree of protection</b>  |                                   | IP 66 / Nema 1, 2, 3, 3R, 4, 6, 12 and 13 / Class II                     |                    |                         |
| <b>Mounting (mm)</b>         | panel cut-out<br>mounting centres | Ø 31   |                    |                         |
| <b>Depth below head (mm)</b> |                                   | 57.2 x 44.5 (with legend 9001KN2●●), 57.2 x 50.8 (with legend 9001KN3●●) |                    |                         |
| <b>Connection</b>            |                                   | Screw clamp terminals  |                    |                         |
| <b>References</b>            | CO                                | <b>9001KR1UH13</b>   | <b>9001KR3UH13</b> | <b>9001KR2UH13</b>      |
|                              | NO                                | <b>9001KR1UH5</b>  | <b>9001KR3UH5</b>  | <b>9001KR2UH5</b>       |



| Mushroom head pushbuttons, latching (1) | Emergency switching off   | Emergency stop  |                      |
|---|---|---|----------------------|
| <b>Type of push</b>                     | Push-pull<br>Ø 41 mushroom head   Ø 35 mushroom head                        | Turn-to-Release, trigger action<br>Ø 40 red mushroom head                             |                      |
| <b>Degree of protection</b>             | IP 66 / Nema 1, 2, 3, 3R, 4, 6, 12 and 13 / Class II                        | IP 66 / Nema 1, 2, 3, 3R, 4, 6, 12 and 13 / Class III                                 |                      |
| <b>Mounting (mm)</b>                    | panel cut-out<br>mounting centres   | Ø 31  |                      |
| <b>Depth below head (mm)</b>            | 57.2 x 44.5 (with legend 9001KN2●●),<br>57.2 x 50.8 (with legend 9001KN3●●) | 57,2 x 44,5 (without legend plate),<br>100 x 100 ((with legend plate 9001KN8330) (2)) |                      |
| <b>Connection</b>                       | Screw clamp terminals   |   |                      |
| <b>References</b>                       |   | <b>9001KR16</b>   |                      |
|   | –   | –   |                      |
|   | CO  | <b>9001KR9R94H13</b>  | <b>9001KR9R20H13</b> |
|   | NC  | <b>9001KR9RH6</b>   | <b>9001KR9R20H6</b>  |
|   | 2NO + 2NC   | –   | <b>9001KR16H2</b>    |
|   | NO  | –   | <b>9001KR16H13</b>   |

(1) Mushroom head switching off mechanical latching pushbuttons conform to standard IEC 60364-5-53 and EN/IEC 60947-5-5. Mushroom trigger action and mechanical latching head Emergency stop pushbuttons conforming to standard EN/IEC 60204-1 and EN/ISO 13850, to Machinery directive 2006/42/EC and standard EN/IEC 60947-5-5.  
(2) For yellow circular Emergency Stop legend plates: see page 2/19



#### Selector switches and key switches

|                                     |                                   |  |                     |                     |  |
|-------------------------------------|-----------------------------------|--|---------------------|---------------------|--|
| <b>Type of operator</b>             |                                   | Long black handle  |                     |                     | Key, n° 455                                |
|                                     | positions (2)                     | 3 - spring return  | 2 - stay put        | 2 - spring return   | 3 - stay put                               |
| <b>Number and type of positions</b> |                                   |  |                     |                     |  |
| <b>Degree of protection</b>         |                                   | IP 66 / Nema 1, 2, 3, 3R, 4, 6, 12 and 13 / Class II                     |                     |                     |  |
| <b>Mounting (mm)</b>                | panel cut-out<br>mounting centres | Ø 31   |                     |                     |  |
| <b>Depth below head (mm)</b>        |                                   | 57.2 x 44.5 (with legend 9001KN2●●), 57.2 x 50.8 (with legend 9001KN3●●) |                     |                     |  |
| <b>Connection</b>                   |                                   | Screw clamp terminals  |                     |                     |  |
| <b>References</b>                   | NO                                | –  | <b>9001KS11FBH5</b> | <b>9001KS34FBH5</b> | –  |
|                                     | CO                                | <b>9001KS53FBH1</b>  | –                   | –                   | <b>9001KS43FBH1</b>   <b>9001KS11K1RH1</b> |

(2) The symbol indicates key withdrawal position.



## Light functions



1

### Pilot lights

|                       |                  |  |                     |                     |                                    |
|-----------------------|------------------|--|---------------------|---------------------|------------------------------------|
| <b>Type of head</b>   |                  | Smooth lens cap  |                     |                     |                                    |
| Degree of protection  |                  | IP 66 / Nema 1, 2, 3, 3R, 4, 6, 12 and 13 / Class II                     |                     |                     |                                    |
| Mounting (mm)         | panel cut-out    | Ø 31   |                     |                     |                                    |
|                       | mounting centres | 57.2 x 44.5 (with legend 9001KN2●●), 57.2 x 50.8 (with legend 9001KN3●●) |                     |                     |                                    |
| Depth below head (mm) |                  | 42   |                     |                     |                                    |
| Connection            |                  | Screw clamp terminals  |                     |                     |                                    |
| Type of light block   |                  | With high luminosity LED (included)                                      |                     |                     | Incandescent BA 9s bulb (included) |
| References            |                  | 24 V AC/DC   | 48 V AC/DC          | 120 V AC/DC         | 230 V AC                           |
|                       | green ●          | <b>9001KP35LGG9</b>  | <b>9001KP36LGG9</b> | <b>9001KP38LGG9</b> | <b>9001KP7G9</b>                   |
|                       | red ●            | <b>9001KP35LRR9</b>  | <b>9001KP36LRR9</b> | <b>9001KP38LRR9</b> | <b>9001KP7R9</b>                   |
|                       | yellow ●         | <b>9001KP35LYA9</b>  | <b>9001KP36LYA9</b> | <b>9001KP38LYA9</b> | <b>9001KP7A9</b>                   |



### Illuminated pushbuttons, spring return

|                       |                  |  |                        |                        |                                    |
|-----------------------|------------------|--|------------------------|------------------------|------------------------------------|
| <b>Type of head</b>   |                  | Spring return flush push   |                        |                        |                                    |
| Degree of protection  |                  | IP 66 / Nema 1, 2, 3, 3R, 4, 6, 12 and 13 / Class II                     |                        |                        |                                    |
| Mounting (mm)         | panel cut-out    | Ø 31   |                        |                        |                                    |
|                       | mounting centres | 57.2 x 44.5 (with legend 9001KN2●●), 57.2 x 50.8 (with legend 9001KN3●●) |                        |                        |                                    |
| Depth below head (mm) |                  | 42   |                        |                        |                                    |
| Connection            |                  | Screw clamp terminals  |                        |                        |                                    |
| Type of light block   |                  | With high luminosity LED (included)                                      |                        |                        | Incandescent BA 9s bulb (included) |
| References            |                  | 24 V AC/DC   | 48 V AC/DC             | 120 V AC/DC            | 230 V AC                           |
|                       | green ●          | CO <b>9001K3L35LGGH13</b>  | <b>9001K3L36LGGH13</b> | <b>9001K3L38LGGH13</b> | <b>9001K2L7RH13</b>                |
|                       | red ●            | CO <b>9001K3L35LRRH13</b>  | <b>9001K3L36LRRH13</b> | <b>9001K3L38LRRH13</b> | <b>9001K2L7GH13</b>                |
|                       | yellow ●         | CO <b>9001K3L35LYAH13</b>  | <b>9001K3L36LYAH13</b> | <b>9001K3L38LYAH13</b> | <b>9001K2L7AH13</b>                |



### Illuminated Ø 41 mushroom head pushbuttons, latching, high luminosity LED

|                       |                  |  |                       |                       |                                    |
|-----------------------|------------------|--|-----------------------|-----------------------|------------------------------------|
| Degree of protection  |                  | IP 66 / Nema 1, 2, 3, 3R, 4, 6, 12 and 13 / Class II                               |                       |                       |                                    |
| Mounting (mm)         | panel cut-out    | Ø 31   |                       |                       |                                    |
|                       | mounting centres | 57.2 x 44.5 (with legend 9001KN2●●), 57.2 x 50.8 (with legend 9001KN3●●)           |                       |                       |                                    |
| Depth below head (mm) |                  | 42   |                       |                       |                                    |
| Connection            |                  | Screw clamp terminals  |                       |                       |                                    |
| Type of light block   |                  | With high luminosity LED (included)  |                       |                       | Incandescent BA 9s bulb (included) |
|                       |                  | 24 V AC/DC   | 48 V AC/DC            | 120 V AC/DC           | 230 V AC/DC                        |
| <b>Type of head</b>   |                  | 2 position, push-pull  |                       |                       |                                    |
| References            | red ●            | CO <b>9001KR9P35RH13</b>   | <b>9001KR9P36RH13</b> | <b>9001KR9P38RH13</b> | <b>9001KR9P7RH13</b>               |
| <b>Type of head</b>   |                  | 3 position, push-pull (pull: spring return, centre: stay put, push: spring return) |                       |                       |                                    |
| References            | red ●            | NC + NC late break <b>9001KR8P35RH25</b>   | <b>9001KR8P36RH25</b> | <b>9001KR8P38RH25</b> | <b>9001KR8P7RH25</b>               |

## Accessories



### Contact blocks with protected terminals

|                 |                       |         |
|-----------------|-----------------------|---------|
| Type of contact | Single contact blocks |         |
| Connection      | Screw clamp terminals |         |
| References      | CO                    | 9001KA1 |
|                 | NO                    | 9001KA2 |
|                 | NC                    | 9001KA3 |
|                 | CO, late break        | 9001KA4 |
|                 | NC, late break        | 9001KA5 |
|                 | NO, early make        | 9001KA6 |



### Enclosures

| Type            | Number of Ø 30 mm cut-outs | NEMA ratings       | Reference |
|-----------------|----------------------------|--------------------|-----------|
| Aluminium       | 1                          | 1, 3, 4, 6, 12, 13 | 9001KY1   |
|                 | 2                          | 1, 3, 4, 6, 12, 13 | 9001KY2   |
|                 | 3                          | 1, 3, 4, 6, 12, 13 | 9001KY3   |
|                 | 4                          | 1, 3, 4, 6, 12, 13 | 9001KY4   |
| Stainless steel | 1                          | 1, 3, 4, 4X, 13    | 9001KYSS1 |
|                 | 2                          | 1, 3, 4, 4X, 13    | 9001KYSS2 |
|                 | 3                          | 1, 3, 4, 4X, 13    | 9001KYSS3 |



### Legends

| Legends |                                | 44 x 43 mm                    | 57 x 57 mm                  | Ø 60                         | Ø 90        |
|---------|--------------------------------|-------------------------------|-----------------------------|------------------------------|-------------|
| Type    | Colour of legend               | Aluminium<br>black background | Plastic<br>white background | Plastic<br>Yellow background |             |
| Marking | Blank                          | 9001KN200                     | 9001KN100WP                 | 9001KN9100                   | 9001KN8100  |
|         | START                          | 9001KN201                     | 9001KN101WP                 | –                            | –           |
|         | STOP (red background)          | 9001KN202                     | 9001KN102RP                 | –                            | –           |
|         | FORWARD                        | 9001KN206                     | 9001KN106WP                 | –                            | –           |
|         | REVERSE                        | 9001KN207                     | 9001KN107WP                 | –                            | –           |
|         | RESET                          | 9001KN223                     | 9001KN123WP                 | –                            | –           |
|         | PULL TO START/<br>PUSH TO STOP | 9001KN379                     | 9001KN179WP                 | –                            | –           |
|         | EMERGENCY STOP                 | –                             | –                           | 9001KN9330                   | 9001KN8330  |
|         | ARRET D'URGENCE                | –                             | –                           | 9001KN9330F                  | 9001KN8330F |
|         | PARADA DE EMERGENCIA           | –                             | –                           | 9001KN9330S                  | 9001KN8330S |



positions (°)

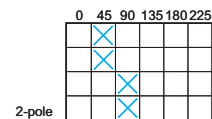
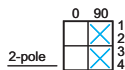

### Cam switches, K1 / K2 series

| Function   | Switches                                | ON-OFF switches                      | Stepping switches                      |
|--|---|--------------------------------------|--|
| Degree of protection front face                        | 45° switching angle<br>IP 65 (1)        | 90° switching angle<br>IP 65 (1)     | with "0" position<br>IP 65 (1)         |
| Conventional thermal current (Ith)                     | 12 A   20 A                             | 12 A   20 A                          | 12 A   20 A                            |
| Rated insulation voltage (Ui) conforming to IEC60947-1 | 690 V                                   | 690 V                                | 690 V                                  |
| Number of positions                                    | 2                                       | 2                                    | 2 + "0" position                       |
| Number of poles  | 2                                       | 2                                    | 2                                      |
| Dimensions of front plate (mm)                         | 45 x 45                                 | 45 x 45                              | 45 x 45                                |
| Front mounting method                                  | Multifixing plate, 45 x 45 mm           | <b>K1B002ALH</b>   <b>K2B 002ALH</b> | <b>K1B1002HLH</b>   <b>K2B 1002HLH</b> |
|  | Plastic mounting plate for Ø 22 mm hole | <b>K1B002ACH</b>   <b>K2B 002ACH</b> | <b>K1B1002HCH</b>   <b>K2B 1002HCH</b> |
|  |   | <b>K1D012QLH</b>   <b>K2D012QLH</b>  | <b>K1D012QCH</b>   <b>K2D012QCH</b>    |



positions (°)

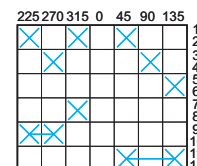
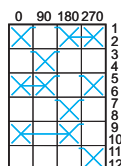
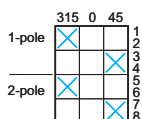

### Cam switches, K1 / K2 series

| Function   | Changeover switches                     | Ammeter switches                                | Voltmeter switches  |
|--|---|---|---|
| Degree of protection front face                        | IP 65 (1)                               | IP 65 (1)                                       | IP 65 (1)   |
| Conventional thermal current (Ith)                     | 12 A   20 A                             | 12 A   20 A                                     | 12 A   20 A   |
| Rated insulation voltage (Ui) conforming to IEC60947-1 | 690 V                                   | 690 V   | 690 V   |
| Number of positions                                    | 2 + "0" position                        | 3 + "0" position<br>(3 circuits + "0" position) | 6 + "0" position (measurements between 3 phases & N + "0" pos.) |
| Number of poles  | 2                                       | 4   | 7   |
| Dimensions of front plate (mm)                         | 45 x 45                                 | 45 x 45   | 45 x 45   |
| Front mounting method                                  | Multifixing plate, 45 x 45 mm           | <b>K1D002ULH</b>   <b>K2D002ULH</b>             | <b>K1F003MLH</b>   to be compiled *                             |
|  | Plastic mounting plate for Ø 22 mm hole | <b>K1D002UCH</b>   <b>K2D002UCH</b>             | <b>K1F003MCH</b>   to be compiled *                             |
|  |   | <b>K1F027MLH</b>   to be compiled *             | <b>K1F027MCH</b>   to be compiled *                             |

(1) With seal KZ73 for switch with Multifixing plate, with seal KZ65 for Ø 22 mm hole mounting switches. Seal to be ordered separately.

(\*) Please consult your Schneider Electric agency.



positions (°)

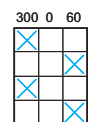
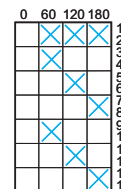
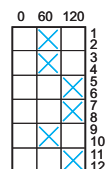

### Cam switches with key operated lock, K1 series

| Function   | Stepping switches             | Run switches                        | Changeover switches + "0" pos.      |
|--|-------------------------------|-------------------------------------|-------------------------------------|
| Degree of protection front face                        | IP 65                         | IP 65                               | IP 65                               |
| Conventional thermal current (Ith)                     | 12 A                          | 12 A                                | 12 A                                |
| Rated insulation voltage (Ui) conforming to IEC60947-1 | 690 V                         | 690 V                               | 690 V                               |
| Number of positions                                    | 2 + "0" position              | 3 + "0" position                    | 2 + "0" position                    |
| Number of poles  | 3                             | 2                                   | 2                                   |
| Dimensions of front plate (mm)                         | 55 x 100                      | 55 x 100                            | 55 x 100                            |
| Colour of handle                                       | red   black                   | red   black                         | red   black                         |
| Front mounting method                                  | Ø 22 mm hole + Ø 43.5 mm hole | <b>K1G043RZ2</b>   <b>K1G043RZ4</b> | <b>K1D002UZ2</b>   <b>K1D002UZ4</b> |

## 10 to 150 A ratings



positions (°)

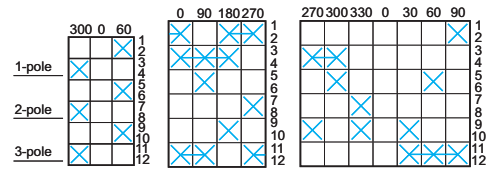
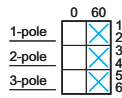

### Cam switches, K10series

| Function   | Switches            | Changeover switches | Ammeter switches | Voltmeter switches |            |            |            |
|--|---------------------|---------------------|------------------|--------------------|------------|------------|------------|
|  | 60° switching angle | with "0" position   |                  |                    |            |            |            |
| Degree of protection front face                        | IP 65               | IP 65               | IP 65            | IP 65              |            |            |            |
| Conventional thermal current (Ith)                     | 10 A                | 10 A                | 10 A             | 10 A               |            |            |            |
| Rated insulation voltage (Ui) conforming to IEC60947-1 | 440 V               | 440 V               | 440 V            | 440 V              |            |            |            |
| Number of positions                                    | 2                   | 2 + "0" position    | 3 + "0" pos. (1) | 6 + "0" pos. (2)   |            |            |            |
| Number of poles  | 1                   | 2                   | 3                | 3                  |            |            |            |
| Dimensions of front plate (mm)                         | 30 x 30             | 30 x 30             | 30 x 30          | 30 x 30            |            |            |            |
| Front mounting method By Ø 16 mm or 22 mm hole         | K10A001ACH          | K10B002ACH          | K10C003ACH       | K10D002UCH         | K10F003UCH | K10F003MCH | K10F027MCH |

(1) (3 circuits + "0" position).

(2) (Measurements between 3 phases and N + "0" position).



positions (°)

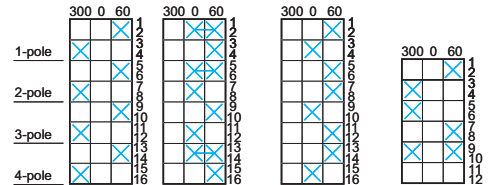
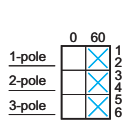

### Cam switches, K30series

| Function   | Switches      | Switches      | Changeover        | Starting      | Starting      | Reversing     |               |
|--|---------------|---------------|-------------------|---------------|---------------|---------------|---------------|
|  |               | ON-OFF        | with "0" position | star-delta    | 2-speed       |               |               |
| Degree of protection front face                        | IP 40         | IP 40         | IP 40             | IP 40         | IP 40         | IP 40         |               |
| Conventional thermal current (Ith)                     | 32 A          | 32 A          | 32 A              | 32 A          | 32 A          | 32 A          |               |
| Rated insulation voltage (Ui) conforming to IEC60947-1 | 690 V         | 690 V         | 690 V             | 690 V         | 690 V         | 690 V         |               |
| Number of positions                                    | 2             | 2             | 3                 | 3             | 3             | 3             |               |
| Number of poles  | 3             | 3             | 4                 | 3             | 3             | 3             |               |
| Dimensions of front plate (mm)                         | 64 x 64       | 64 x 64       | 64 x 64           | 64 x 64       | 64 x 64       | 64 x 64       |               |
| Front mounting method Multifixing                      | K30C003AP (3) | K30C003HP (3) | K30D004HP (3)     | K30H004UP (3) | K30H001YP (3) | K30H004PP (3) | K30E003WP (3) |

(3) To order switches with other thermal current ratings (50, 63, 115, 150 A): replace the number 30 in the reference by 50, 63, 115 or 150 respectively.

Example: a switch with a 32 A current rating, for example K30C003AP, becomes K50 C003AP for a current rating of 50 A.

## Accessories for cam switches K1/K2

### Rubber seals

| For IP 65 degree of protection | For use with heads | with 45 x 45 mm front plate<br>Ø 22 mm hole or 4 hole front mtg. | with 60 x 60 mm front plate<br>Ø 22 mm hole or 4 hole front mtg. | with 45 x 45 mm front plate<br>multifixing |
|--------------------------------|--------------------|--|--|--|
| References (5)*                |                    | KZ65   | KZ66   | KZ73                                       |

\* sold in lots of



### Ø 40 mm / Up to IP54

| Complete, pre-wired tower lights |                                     | Steady light   |                              |             | Steady / Flashing light (1)  |               |
|----------------------------------|-------------------------------------|----------------|------------------------------|-------------|------------------------------|---------------|
| Light source (included)          |                                     | LEDs           |                              |             | LEDs                         |               |
| Base mount                       |                                     | Base mounting  | Support tube mounting, 17 mm |             | Support tube mounting, 17 mm |               |
| Buzzer                           |                                     | Without buzzer |                              |             | With buzzer + flashing light |               |
| Degree of protection             |                                     | up to IP54     |                              |             | up to IP54                   |               |
| Voltage                          |                                     | 24V AC/DC      | 24V AC/DC                    | 100-240V AC | 24V AC/DC                    | 100 - 240V AC |
| References (2)                   | Red                                 | XVC4B1K        | XVC4B1                       | XVC4M1 (4)  | XVC4B15S                     | XVC4M15S (4)  |
|                                  | Red / orange                        | XVC4B2K        | XVC4B2                       | XVC4M2      | XVC4B25S                     | XVC4M25S      |
|                                  | Red / Orange / green                | XVC4B3K        | XVC4B3                       | XVC4M3      | XVC4B35S                     | XVC4M35S      |
|                                  | red / orange / green / blue         | XVC4B4K        | XVC4B4                       | XVC4M4      | XVC4B45S                     | XVC4M45S      |
|                                  | red / orange / green / blue / Clear | XVC4B5K        | XVC4B5                       | XVC4M5      | XVC4B55S                     | XVC4M55S      |



### Ø 60 mm / Up to IP54

| Complete, pre-wired tower lights |                                     | Steady light   |                              |                  | Steady / Flashing light (1)  |                  |           |
|----------------------------------|-------------------------------------|----------------|------------------------------|------------------|------------------------------|------------------|-----------|
| Light source (included)          |                                     | LEDs           |                              |                  | LEDs                         |                  |           |
| Base mount                       |                                     | Base mounting  | Support tube mounting, 22 mm |                  | Support tube mounting, 22 mm | Base mounting    |           |
| Buzzer                           |                                     | Without buzzer |                              |                  | With buzzer + flashing light |                  |           |
| Degree of protection             |                                     | up to IP54     |                              |                  | up to IP54                   |                  |           |
| Voltage                          |                                     | 24V AC/DC      | 24V AC/DC                    | 100-240 V AC (4) | 24V AC/DC                    | 100-240 V AC (4) |           |
| References (2)                   | Red                                 | XVC6B1K        | XVC6B1                       | XVC6M1 (3)       | XVC6B15S (3)                 | XVC6M15S         | XVC6M15SK |
|                                  | Red / orange                        | XVC6B2K        | XVC6B2                       | XVC6M2 (3)       | XVC6B25S (3)                 | XVC6M25S         | XVC6M25SK |
|                                  | Red / Orange / green                | XVC6B3K        | XVC6B3                       | XVC6M3 (3)       | XVC6B35S (3)                 | XVC6M35S         | XVC6M35SK |
|                                  | red / orange / green / blue         | XVC6B4K        | XVC6B4                       | XVC6M4 (3)       | XVC6B45S (3)                 | XVC6M45S         | XVC6M45SK |
|                                  | red / orange / green / blue / Clear | XVC6B5K        | XVC6B5                       | XVC6M5 (3)       | XVC6B55S (3)                 | XVC6M55S         | XVC6M55SK |



### Ø 100 mm / Up to IP54

| Complete, pre-wired tower lights |                                     | Steady / Flashing light (1) |                 |           |                              |           |                 |
|----------------------------------|-------------------------------------|-----------------------------|-----------------|-----------|------------------------------|-----------|-----------------|
| Light source (included)          |                                     | LEDs                        |                 |           |                              |           |                 |
| Base mount                       |                                     | Base mounting               |                 |           |                              |           |                 |
| Buzzer                           |                                     | Without buzzer              |                 |           | With buzzer + flashing light |           |                 |
| Degree of protection             |                                     | up to IP54                  |                 |           | up to IP54                   |           |                 |
| Voltage                          |                                     | 24V DC (4)                  | 100-240V AC (4) | 24VDC (4) | 100-240V AC (4)              | 24VDC (4) | 100-240V AC (4) |
| References (2)                   | Red                                 | XVC1B1K                     | XVC1M1K         | XVC1B1SK  | XVC1M1SK                     | XVC1B1HK  | XVC1M1HK        |
|                                  | Red / orange                        | XVC1B2K                     | XVC1M2K         | XVC1B2SK  | XVC1M2SK                     | XVC1B2HK  | XVC1M2HK        |
|                                  | Red / Orange / green                | XVC1B3K                     | XVC1M3K         | XVC1B3SK  | XVC1M3SK                     | XVC1B3HK  | XVC1M3HK        |
|                                  | red / orange / green / blue         | XVC1B4K                     | XVC1M4K         | XVC1B4SK  | XVC1M4SK                     | -         | -               |
|                                  | red / orange / green / blue / Clear | XVC1B5K                     | XVC1M5K         | XVC1B5SK  | XVC1M5SK                     | -         | -               |

(1) Flashing function can be simply selected/programmed by wiring

(2) The colours are listed in the same order as the mounting order of the illuminated units (from top to bottom)

(3) To order products for base mounting, add the letter K to the end of the reference (ex. XVC6M1K)

(4) NPN only

1

Ø 45 mm / IP40



| Illuminated beacons XVDLS |                  | Steady light                                      | Flashing light                |
|---------------------------|------------------|---|-------------------------------|
| Light source              |                  | Incandescent BA 15d bulb, 5 W max. (not included) | "Flash" discharge tube, 0.5 J |
| Degree of protection      |                  | IP 40   |                               |
| References (1)            | 24...230 V AC/DC | XVDLS3●   | –                             |
|                           | 24 V AC/DC       | –   | XVDLS6B●                      |
|                           | 120 V AC         | –   | XVDLS6G●                      |
|                           | 230 V AC         | –   | XVDLS6M●                      |

(1) To obtain the complete reference, replace the ● by the number designating the colour as follow: 3 = green , 4 = red , 5 = orange, 6 = blue, 7 = clear, 8 = yellow.

## Accessories

### XVDLS

| Incandescent bulbs, with BA 15d base | Beacons XVDLS |            |            |
|--------------------------------------|---------------|------------|------------|
| Description                          | 24 V, 4 W     | 120 V, 5 W | 230 V, 5 W |
| References                           | DL1BEBS       | DL1BEGS    | DL1BEMS    |



### XVC4 / XVC6

| Mounting accessories    | Tower lights Ø 40 mm, XVC4 |        |        | Tower lights Ø 60 mm, XVC6 |                          |   |
|-------------------------|----------------------------|--------|--------|----------------------------|--------------------------|---|
| Description             | Support tube mounting      |        |        | Support tube mounting      | Base mounting            | Support tube mounting                           |
| Diameter (mm)           | Ø 90                       | Ø 84   | –      | Ø 100                      | Ø 84                     | –   |
| For use with            | –                          | –      | –      | XVC6●●and<br>XVC6●●5S      | XVC6●●K and<br>XVC6●●5SK | XVC6B●and<br>XVC6B●5S,<br>XVC6M●and<br>XVC6M●5S |
| Height to be added (mm) | 32                         | 24,5   | 82     | 30                         | 21,6                     | 82  |
| References              | Metal fixing plate         | XVCZ11 | –      | XVCZ02                     | XVCZ12                   | –   |
|                         | Plastic fixing plate       | –      | XVCZ01 | –                          | –                        | –   |
|                         | Wall mounting bracket      | –      | –      | XVCZ31                     | –                        | XVCZ32  |



### XVC1

| Mounting accessories    | Tower lights Ø 100 mm, XVC1 |                       |                      |                          |
|-------------------------|-----------------------------|-----------------------|----------------------|--------------------------|
| Description             | Vertical support            |                       |                      |                          |
| Diameter (mm)           | Ø 140                       | Ø 140                 | –                    | –                        |
| For use with            | XVC1●●K<br>and<br>XVC1●●SK  | XVC1●●HK (with siren) | XVC1●●K and XVC1●●SK | XVC1●●HK<br>(with siren) |
| Height to be added (mm) | 300                         | 306                   | –                    | –                        |
| References              | Metal fixing plate (2)      | XVCZ13                | XVCZ14               | –                        |
|                         | Metal fixing bracket        | –                     | –                    | XVCZ23                   |
|                         |                             |                       |                      | XVCZ24                   |

(2) Chromium plated-steel extension tube



### Ø 70 mm / Up to IP66

| Illuminated beacons XVBL    |                  | Steady light                                       |                                 | Flashing light                  |                                |
|-----------------------------|------------------|--|---------------------------------|---------------------------------|--------------------------------|
| <b>Light source</b>         |                  | Incandescent BA 15d bulb, 10 W max. (not included) | Protected BA 15d LED (included) | Protected BA 15d LED (included) | "Flash" discharge tube 5 J (2) |
| <b>Degree of protection</b> |                  | IP 66  |                                 |                                 |                                |
| <b>References (1)</b>       | 12...250 V AC/DC | <b>XVBL3●</b>                                      | –                               | –                               | –                              |
|                             | 24 V AC/DC       | –  | <b>XVBL0B●</b>                  | <b>XVBL1B●</b>                  | <b>XVBL6B●</b>                 |
|                             | 120 V AC         | –  | <b>XVBL0G●</b>                  | <b>XVBL1G●</b>                  | <b>XVBL6G●</b>                 |
|                             | 230 V AC         | –  | <b>XVBL0M●</b>                  | <b>XVBL1M●</b>                  | <b>XVBL6M●</b>                 |



### Ø 70 mm / Up to IP66

| Tower lights XVBC comprising 2 to 5 signalling units (3) |                               | Base units        | Steady light                                       |                        | Flashing light         | "Flash" light                  | Audible units (90 db at 1 m) |
|--|-------------------------------|-------------------|--|------------------------|------------------------|--------------------------------|------------------------------|
| <b>Light source</b>                                      |                               | –                 | Incandescent BA 15d bulb, 10 W max. (not included) | Integral protected LED | Integral protected LED | "Flash" discharge tube 5 J (2) | –                            |
| <b>Degree of protection</b>                              |                               | IP 66             |  |                        |                        |                                |                              |
| <b>Base unit references</b>                              | with cover                    | <b>XVBC21 (4)</b> | –  | –                      | –                      | –                              | –                            |
|  | without cover                 | <b>XVBC07 (5)</b> | –  | –                      | –                      | –                              | –                            |
| <b>References (2)</b>                                    | 12... 230 V AC/DC             | –                 | <b>XVBC3●</b>                                      | –                      | –                      | –                              | –                            |
|  | 24 V AC/DC                    | –                 | –  | <b>XVBC2B●</b>         | <b>XVBC5B●</b>         | <b>XVBC6B●</b>                 | –                            |
|  | 120 V AC                      | –                 | –  | <b>XVBC2G●</b>         | <b>XVBC5G●</b>         | <b>XVBC6G●</b>                 | –                            |
|  | 230 V AC                      | –                 | –  | <b>XVBC2M●</b>         | <b>XVBC5M●</b>         | <b>XVBC6M●</b>                 | –                            |
| <b>Audible unit references</b>                           | 12...48 V AC/DC               | –                 | –  | –                      | –                      | –                              | <b>XVBC9B</b>                |
|  | unidirectional 120...230 V AC | –                 | –  | –                      | –                      | –                              | <b>XVBC9M</b>                |

(1) To obtain the complete reference, replace the ● by the number designating the colour as follow: 3 = green , 4 = red , 5 = orange, 6 = blue, 7 = clear, 8 = yellow.

(2) To order a lens unit with a **10 J** discharge tube, replace the number 6 by 8 in the reference (example: **XVBL6B●** becomes **XVBL8B●**).

(3) A tower light comprises: 1 base unit + 1 to 5 signalling units maximum.

(4) For connection on AS-Interface, order base unit XVBC21A (side cable entry) or XVBC21B (bottom cable entry with M12 connector on flying lead).

(5) For indicator banks with "flash" discharge tube unit.

1



### Ø 70 mm / Up to IP54

| Illuminated beacons XVEL    |                   | Steady light  |                 | Flashing light              |
|-----------------------------|-------------------|---|-----------------|-----------------------------|
| <b>Light source</b>         |                   | Incandescent<br>BA 15d bulb, 5 W max.<br>(not included) | Integral<br>LED | "Flash" discharge tube, 1 J |
| <b>Degree of protection</b> |                   | IP 42/IP 54 (with sealing kit)                          |                 |                             |
| <b>References (1)</b>       | 24... 240 V AC/DC | XVEL3●  | –               |                             |
|                             | 24 V AC/DC        | –   | XVEL2B●         | XVEL6B●                     |
|                             | 120 V AC          | –   | XVEL2G●         | XVEL6G●                     |
|                             | 230 V AC          | –   | XVEL2M●         | XVEL6M●                     |

### Ø 70 mm / Up to IP54



| Indicator banks XVEC<br>comprising 2 to 5 signalling units (2) |                  | Base units                     | Steady light  |                 | Flashing light  | "Flash" light                    | Audible units (85 db at 1 m) |
|--|------------------|--------------------------------|---|-----------------|-----------------|----------------------------------|------------------------------|
| <b>Light source</b>  |                  | –                              | Incandescent<br>BA 15d bulb, 5 W<br>max. (not included) | Integral<br>LED | Integral<br>LED | "Flash"<br>discharge tube<br>1 J | –                            |
| <b>Degree of protection</b>                                    |                  | IP 42/IP 54 (with sealing kit) |   |                 |                 |                                  |                              |
| <b>Base unit references</b>                                    | IP 42            | XVEC21                         | –   | –               | –               | –                                | –                            |
|  | IP 54            | XVEC21P                        | –   | –               | –               | –                                | –                            |
| <b>Lens unit references (1)</b>                                | 24...230 V AC/DC | –                              | XVEC3●  | –               | –               | –                                | –                            |
|  | 24 V AC/DC       | –                              | –   | XVEC2B●         | XVEC5B●         | XVEC6B●                          | XVEC9B                       |
|  | 120 V AC         | –                              | –   | XVEC2G●         | XVEC5G●         | XVEC6G●                          | XVEC9G                       |
|  | 230 V AC         | –                              | –   | XVEC2M●         | XVEC5M●         | XVEC6M●                          | XVEC9M                       |

(1) To obtain the complete reference, replace the● by the number designating the colour as follow: 3 = green , 4 = red , 5 = orange, 6 = blue, 7 = clear, 8 = yellow.

(2) A tower light comprises: 1 base unit + 1 to 5 signalling units maximum.



### Modular tower lights Ø 45, Ø 50 mm, complete or for customer assembly

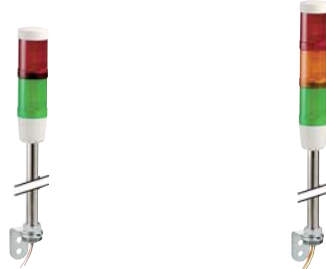

#### Ø 45 mm / IP42

| Complete, pre-wired tower light XVM (1) | 2 sig. units + integral buzzer (2)       |                                 | 3 signalling units + integral buzzer (2) |                                 |  |                                 |              |
|---|--|---------------------------------|--|---------------------------------|--|---------------------------------|--------------|
|   | Steady light                             |                                 | Steady light                             |                                 | Steady light + "flash" (3)               |                                 |              |
| Light source (included)                 | Incandescent<br>BA 15d bulb, 5 W<br>max. | BA 15d<br>"Super bright"<br>LED | Incandescent<br>BA 15d bulb, 5 W<br>max. | BA 15d<br>"Super bright"<br>LED | Incandescent<br>BA 15d bulb, 5 W<br>max. | BA 15d<br>"Super bright"<br>LED |              |
| Degree of protection                    | IP 54                                    |                                 |  |                                 |  |                                 |              |
| Signalling colours                      | Red - Green                              |                                 | Red - Orange - Green                     |                                 |  |                                 |              |
| References                              | 24 V AC/DC                               | XVMB1RGS                        | XVMB2RGSSB                               | XVMB1RAGS                       | XVMB2RAGSSB                              | XVMB1R6AGS                      | XVMB2R6AGSSB |
|   | 120 V AC/DC (bulb) - 120 V AC (LED)      | XVMG1RGS                        | XVMG2RGSSB                               | XVMG1RAGS                       | XVMG2RAGSSB                              | XVMG1R6AGS                      | XVMG2R6AGSSB |
|   | 230 V AC/DC (bulb) - 230 V AC (LED)      | XVMM1RGS                        | XVMM2RGSSB                               | XVMM1RAGS                       | XVMM2RAGSSB                              | XVMM1R6AGS                      | XVMM2R6AGSSB |

(1) Tower lights XVM are also available as separate components for customised assembly by the user: please refer to [www.schneider-electric.com](http://www.schneider-electric.com).

(2) To order products without an integral buzzer, delete the letter **S** at the end of the reference (example: XVMB2RGS becomes XVMB2RG, XVMB2RGSSB becomes XVMB2RGSB).

(3) Flash signalling colour: red - 0.8 J.



#### Ø 50 mm / IP65

| Tower lights XVP<br>comprising 2 to 5 signalling units (4),<br>black clamping ring (5) | Base unit                             | Steady or<br>flashing light<br>signalling               | "Flash" light signalling           |                                    | Audible units<br>(55...85 dB<br>at 1 m) |
|--|---------------------------------------|---|------------------------------------|------------------------------------|---|
| Light source   | –                                     | Incandescent<br>BA 15d bulb, 7 W<br>max. (not included) | "Flash"<br>discharge tube<br>0.3 J | "Flash"<br>discharge tube<br>0.6 J | –                                       |
| Degree of protection   | IP 65                                 |   |                                    |                                    |   |
| Base unit  | with cover<br>XVPC21                  | –   | –                                  | –                                  | –                                       |
| References (6)   | 250 V max.                            | –   | XVPC3●                             | –                                  | –                                       |
|  | 24 V AC/DC (flash) - 24 V DC (buzzer) | –   | –                                  | XVPC6B●                            | XVPC09B                                 |
|  | 120 V AC                              | –   | –                                  | XVPC6G●                            | XVPC09G                                 |
|  | 230 V AC                              | –   | –                                  | XVPC6M●                            | XVPC09M                                 |

(4) A tower light comprises: 1 base unit + 1 to 5 signalling units maximum.

(5) To order products with a cream clamping ring, add the letter **W** to the end of the reference (example: base unit + green lens unit: XVPC21W + XVPC33W etc.).

(6) To obtain the complete reference, replace the ● by the number designating the colour as follow: 3 = green , 4 = red , 5 = orange, 6 = blue, 7 = clear, 8 = yellow.

1



| Bulbs                |       | Beacons and tower lights<br>XVB / XVP (1) |   |                        |                                    |
|----------------------|-------|---|---|------------------------|------------------------------------|
| Type of light source |       | Incandescent<br>BA 15d base<br>7 W        | Incandescent<br>BA 15d base<br>10 W (not XVP) | LED (2)<br>BA 15d base | Flashing<br>LED (2)<br>BA 15d base |
| References           | 12 V  | DL1BEJ                                    | DL1BLJ  | –                      | –                                  |
|                      | 24 V  | DL1BEB                                    | DL1BLB  | DL1BDB●                | DL1BKB●                            |
|                      | 48 V  | DL1BEE                                    | DL1BLE  | –                      | –                                  |
|                      | 120 V | DL1BEG                                    | DL1BLG  | DL1BDG●                | DL1BKG●                            |
|                      | 230 V | DL1BEM                                    | DL1BLM  | DL1BDM●                | DL1BKM●                            |

(1) Tower lights XVP can be fitted with 5 W incandescent bulbs: see beacons XVDLS / XVE.

(2) To obtain the complete reference, replace the ● by the number designating the colour as follow: 1 = white, 3 = green, 4 = red, 5 = orange, 6 = blue, 8 = yellow.



| Bulbs                |       | Tower lights<br>XVM                |                        |                                    |   |
|----------------------|-------|------------------------------------|------------------------|------------------------------------|---|
| Type of light source |       | Incandescent<br>BA 15d base<br>5 W | LED (3)<br>BA 15d base | Flashing<br>LED (3)<br>BA 15d base | "Flash" discharge<br>tube, 0.8 Joule<br>BA 15d base |
| References           | 24 V  | DL1EDBS                            | DL2EDB●SB              | DL1EKB●SB                          | DL6BB   |
|                      | 120 V | DL1EDGS                            | DL2EDG●SB              | DL1EKG●SB                          | DL6BG   |
|                      | 230 V | DL1EDMS                            | DL2EDM●SB              | DL1EKM●SB                          | DL6BM   |

(3) To obtain the complete reference, replace the ● by the number designating the colour as follows: 1 = white, 3 = green, 4 = red, 6 = blue, 8 = orange.



| Mounting accessories |                        | Beacons and tower lights<br>XVB / XVE                  |  | Tower lights<br>XVP                                    |  | Tower lights<br>XVM                                    |  |
|----------------------|------------------------|--|--|--|--|--|--|
|                      |                        | Aluminium tube with integral black plastic fixing base | Plastic tube with integral black plastic fixing base | Aluminium tube with integral black plastic fixing base | Aluminium tube with steel fixing bracket | Aluminium tube with integral cream plastic fixing base | Aluminium tube with steel fixing bracket |
| Description          |                        | Aluminium tube with integral black plastic fixing base | Plastic tube with integral black plastic fixing base | Aluminium tube with integral black plastic fixing base | Aluminium tube with steel fixing bracket | Aluminium tube with integral cream plastic fixing base | Aluminium tube with steel fixing bracket |
| Diameter (mm)        |                        | Ø 25   | Ø 25   | Ø 20   | Ø 20                                     | Ø 20   | Ø 20                                     |
| Support tubes        | 60 mm                  | XVEZ13   | –  | –  | –  | –  | –  |
|                      | 100 mm                 | –  | –  | –  | XVPC02T                                  | XVMZ02   | XVMZ02T                                  |
|                      | 112 mm                 | –  | –  | XVPC02 (4)   | –  | –  | –  |
|                      | 120 mm                 | XVBZ02   | –  | –  | –  | –  | –  |
|                      | 140 mm                 | –  | XVDC02   | –  | –  | –  | –  |
|                      | 250 mm                 | –  | –  | –  | XVPC03T                                  | XVMZ03   | XVMZ03T                                  |
|                      | 260 mm                 | –  | –  | XVPC03 (4)   | –  | –  | –  |
|                      | 400 mm                 | –  | –  | –  | XVPC04T                                  | XVMZ04   | XVMZ04T                                  |
|                      | 410 mm                 | –  | –  | XVPC04 (4)   | –  | –  | –  |
|                      | 420 mm                 | XVBZ03   | –  | –  | –  | –  | –  |
|                      | 820 mm                 | XVBZ04   | –  | –  | –  | –  | –  |
| Fixing plates,       | for vertical support   | XVBC12   |  | XVPC12 (4)   |  | –  |  |
|                      | for horizontal support | XVBZ01   |  | –  |  | XVMZ06   |  |

(4) To order an aluminium support tube with integral cream fixing base, add the letter W to the end of the reference (example: XVPC02W).



### Ø 84 / 106 mm

| Complete, pre-wired rotating beacons |        | Ø 84 mm                       |           | Ø 106 mm                      |           |
|--------------------------------------|--------|-------------------------------|-----------|-------------------------------|-----------|
| Light source (included)              |        | " Super bright " LEDs         |           |                               |           |
| Base mount                           |        | 3 x Ø 05                      |           |                               |           |
| Buzzer                               |        | Without buzzer                |           |                               |           |
| Degree of protection                 |        | IP23 (IP 65 with accessories) |           | IP23 (IP 55 with accessories) |           |
| Voltage                              |        | 12V AC/DC                     | 24V AC/DC | 12V AC/DC                     | 24V AC/DC |
| References                           | Red    | XVR08J04                      | XVR08B04  | XVR10J04                      | XVR10B04  |
|                                      | Orange | XVR08J05                      | XVR08B05  | XVR10J05                      | XVR10B05  |
|                                      | Green  | XVR08J03                      | XVR08B03  | XVR10J03                      | XVR10B03  |
|                                      | Blue   | XVR08J06                      | XVR08B06  | XVR10J06                      | XVR10B06  |



### Ø 120 mm

| Complete, pre-wired rotating beacons |        | Ø 120 mm              |           |             |           |
|--------------------------------------|--------|-----------------------|-----------|-------------|-----------|
| Light source (included)              |        | " Super bright " LEDs |           |             |           |
| Base mount                           |        | 3 x M5                |           |             |           |
| Buzzer                               |        | Without buzzer        |           | With buzzer |           |
| Degree of protection                 |        | IP23                  |           |             |           |
| Voltage                              |        | 12V AC/DC             | 24V AC/DC | 12V AC/DC   | 24V AC/DC |
| References                           | Red    | XVR12J04              | XVR12B04  | XVR12J04S   | XVR12B04S |
|                                      | Orange | XVR12J05              | XVR12B05  | XVR12J05S   | XVR12B05S |
|                                      | Green  | XVR12J03              | XVR12B03  | XVR12J03S   | XVR12B03S |
|                                      | Blue   | XVR12J06              | XVR12B06  | XVR12J06S   | XVR12B06S |



### Ø 130 mm

| Complete, pre-wired rotating beacons |        | Ø 130 mm                      |          |               |           |           |
|--------------------------------------|--------|-------------------------------|----------|---------------|-----------|-----------|
| Light source (included)              |        | " Super bright " LEDs         |          |               |           |           |
| Base mount                           |        | 3 x Ø 09                      |          |               |           |           |
| Buzzer                               |        | Without buzzer                |          |               |           |           |
| Degree of protection                 |        | IP66 - Resistant to vibration |          | IP66 and IP67 |           |           |
| Voltage                              |        | 12V DC                        | 24V DC   | 24V AC/DC     | 120V AC   | 230V AC   |
| References                           | Red    | XVR13J04                      | XVR13B04 | XVR13B04L     | XVR13G04L | XVR13M04L |
|                                      | Orange | XVR13J05                      | XVR13B05 | XVR13B05L     | XVR13G05L | XVR13M05L |

1



| Accessories for rotating mirrors |          | Reflecting prism | Rubber base              | Metal angle bracket | Metal fixing plate |
|----------------------------------|----------|------------------|--------------------------|---------------------|--------------------|
| To be used for/with              |          | –                | Increasing the IP degree | Horizontal support  | Horizontal support |
| Height (mm)                      |          | –                | –                        | –                   | 300                |
| References                       | Ø 84 mm  | XVRZR1           | XVRZ081                  | XVCZ23              | –                  |
|                                  | Ø 106 mm | XVRZR2           | XVRZ082                  | XVCZ23              | XVCZ13             |
|                                  | Ø 120 mm | XVRZR3           | –                        | XVCZ23              | XVCZ13             |
|                                  | Ø 130 mm | XVRZR3           | –                        | XVR012L             | –                  |

## Electronic alarms and multisound sirens



| Sirens and electronic alarms |              | Sirens   | Multisound sirens pre-wired | Electronic alarms Panel Mount DIN72 |               | Electronic alarms Panel Mount DIN96 |               |
|------------------------------|--------------|----------|-----------------------------|-------------------------------------|---------------|-------------------------------------|---------------|
| Sound level                  |              | 106 dB   | 105 dB                      | 90 dB                               |               | 96 dB                               |               |
| Tones                        |              | 2        | 43                          | 16                                  |               | 16                                  |               |
| Channels                     |              | –        | 8                           | 4                                   |               | 4                                   |               |
| Degree of protection         |              | IP 53    | IP53                        | IP 54                               |               | IP 54                               |               |
| Colors                       |              | White    | White                       | Black                               | White         | Black                               | White         |
| References                   | 12/24V AC/DC | XVS10BMW | –                           | XVS72BMB● (1)                       | XVS72BMW● (1) | XVS96BMB● (1)                       | XVS96BMW● (1) |
|                              | 12/24V DC    | –        | XVS14BMW                    | –                                   | –             | –                                   | –             |
|                              | 120V AC      | XVS10GMW | XVS14GMW                    | –                                   | –             | –                                   | –             |
|                              | 230V AC      | XVS10MMW | XVS14MMW                    | –                                   | –             | –                                   | –             |

(1) To obtain a complete reference, replace the ● by the letter as follow: P = PNP, N = NPN (ex. XVS72BMBP)



| Type XACA "Pistol grip"           |   |                                    |                                    |
|-----------------------------------|---|------------------------------------|------------------------------------|
| Degree of protection              | IP 65 / Nema 4, 4X / Class II   |                                    |                                    |
| Rated operational characteristics | AC 15 (240 V 3 A), DC 13  |                                    |                                    |
| Conventional thermal current      | lthe  | 10 A                               |                                    |
| Connection                        | Screw clamp terminals, 1 x 2.5 mm <sup>2</sup> or 2 x 1.5 mm <sup>2</sup> |                                    |                                    |
| For control of                    | single-speed motors<br>   |                                    | 2-speed motors<br>                 |
| Dimensions (mm)                   | W x H x D   | 52 x 295 x 71 (x 85 with ZA2BS834) | 52 x 295 x 71 (x 85 with ZA2BS834) |
| Number of operators               | mechanically interlocked  | 2                                  |                                    |
|                                   | Emergency stop  | without                            | ZA2BS834                           |
| References                        |   | XACA201                            | XACA2014                           |
|                                   |   |                                    | XACA207                            |
|                                   |   |                                    | XACA2074                           |



| Type XACA                          |  |                                    |                                    |
|------------------------------------|--|------------------------------------|------------------------------------|
| For control of single-speed motors |  |                                    |                                    |
| Dimensions (mm)                    | W x H x D                              | 80 x 314 x 70 (x 90 with ZA2BS834) | 80 x 440 x 70 (x 90 with ZA2BS844) |
| Number of operators                | mechanically interlocked between pairs | 2                                  |                                    |
|                                    | Emergency stop                         | without                            | ZA2BS834                           |
| References                         |  | XACA271                            | XACA2714                           |
|                                    |  |                                    | XACA471                            |
|                                    |  |                                    | XACA4714                           |



|                                    |  |                                    |               |
|------------------------------------|--|------------------------------------|---------------|
| For control of single-speed motors |  |                                    |               |
| Dimensions (mm)                    | W x H x D                              | 80 x 500 x 70 (x 90 with ZA2BS844) | 80 x 560 x 70 |
| Number of operators                | mechanically interlocked between pairs | 6                                  |               |
|                                    | Emergency stop                         | without                            | ZA2BS844      |
| References                         |  | XACA671                            | XACA6714      |
|                                    |  |                                    | XACA871       |

| Empty enclosures type XACA |        |        |        |        |        |        |        |
|----------------------------|--------|--------|--------|--------|--------|--------|--------|
| Number of ways             | 2      | 3      | 4      | 5      | 6      | 8      | 12     |
| References                 | XACA02 | XACA03 | XACA04 | XACA05 | XACA06 | XACA08 | XACA12 |

# Separate components (for mounting in enclosures XACA)

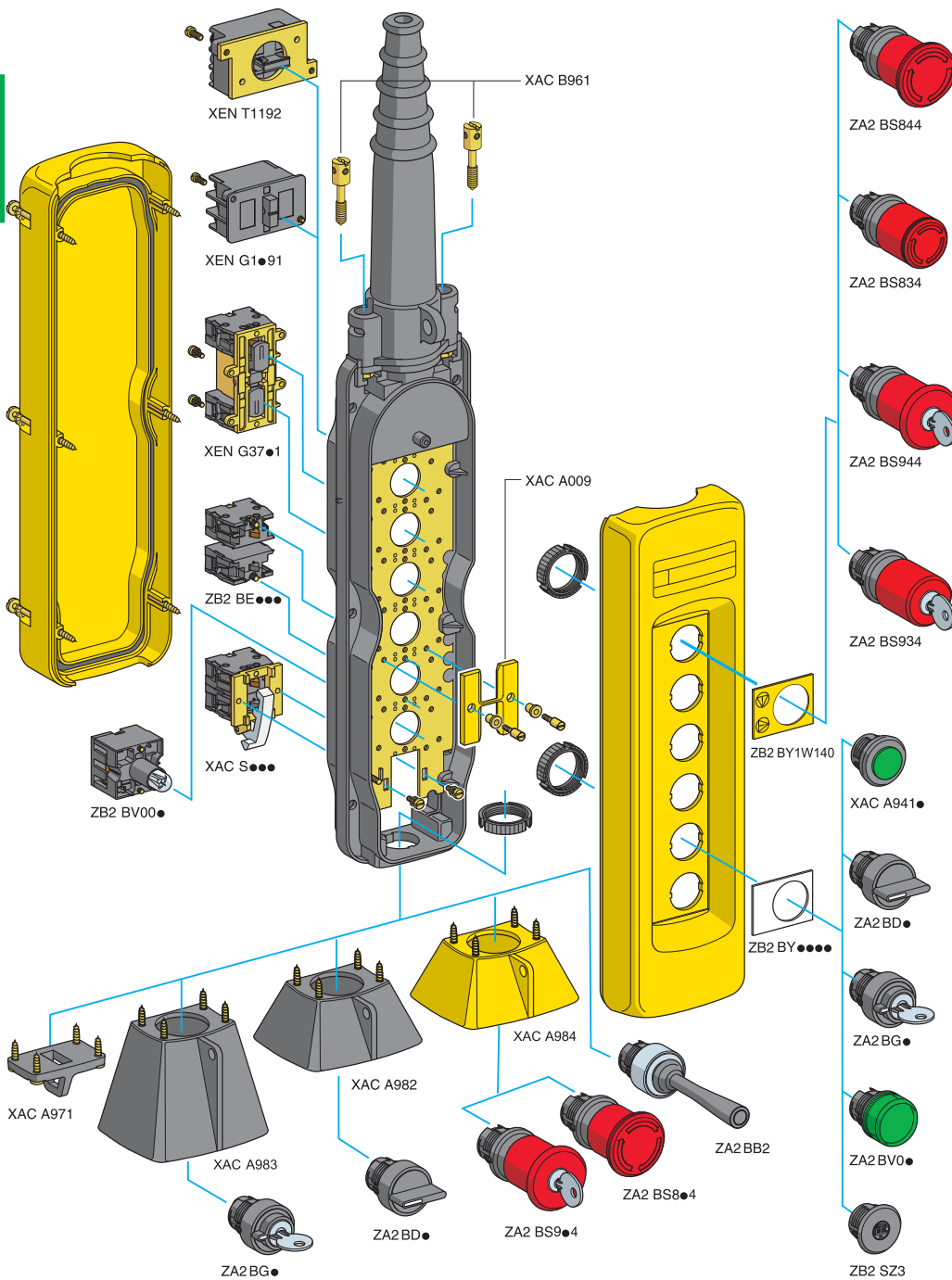

| Mushroom head, latching, trigger action (1) |      |          |
|---|------|----------|
| turn to release                             | Ø 40 | ZA2BS844 |
|   | Ø 30 | ZA2BS834 |

| Mushroom head, latching, trigger action (1) |      |          |
|---|------|----------|
| key release                                 | Ø 40 | ZA2BS944 |
|   | Ø 30 | ZA2BS934 |

| Booted operators |   |          |
|------------------|---|----------|
| white            | ● | XACA9411 |
| black            | ● | XACA9412 |

| Selector switch |                 |        |
|-----------------|-----------------|--------|
|                 | 2 pos. stay put | ZA2BD2 |
|                 | 3 pos. stay put | ZA2BD3 |

| Key switch |                 |        |
|------------|-----------------|--------|
| key n° 455 | 2 pos. stay put | ZA2BG4 |
|            | 3 pos. stay put | ZA2BG5 |

| Pilot light heads |   |         |
|-------------------|---|---------|
| white             | ● | ZA2BV01 |
| green             | ● | ZA2BV03 |
| red               | ● | ZA2BV04 |
| yellow            | ● | ZA2BV05 |

| Pilot light bodies              |  |          |
|---------------------------------|--|----------|
| direct supply                   |  | ZB2BV006 |
| direct supply, through resistor |  | ZB2BV007 |

| Blanking plug            |  |        |
|--------------------------|--|--------|
| with seal and fixing nut |  | ZB2SZ3 |

| Isolating switch, slow break, for front mounting        |  |          |
|---|--|----------|
| Emergency stop NC+NC+NC with positive opening operation |  | XENT1192 |

| Contacts blocks for XACA941• |  |          |
|------------------------------|--|----------|
| Single-speed NC+NO           |  | XENG1491 |
| 2-speed NC+NO+NO             |  | XENG1191 |

| Double blocks latching, slow break |  |          |
|------------------------------------|--|----------|
| Single-speed NO+NO                 |  | XENG3781 |
| Single-speed NO+NC                 |  | XENG3791 |

| Contact blocks  |  |          |
|-----------------|--|----------|
| Single-speed NO |  | ZB2BE101 |
| Single-speed NC |  | ZB2BE102 |

| Contact blocks (for mounting in enclosure base) |  |         |
|---|--|---------|
| NO  |  | XACS101 |
| NC+NO   |  | XACS105 |

| Protective guard (for base mounted units) |  |             |
|---|--|-------------|
| For selector switch                       |  | XACA982/983 |
| For emergency stop pushbutton             |  | XACA984     |

| Legends, 30 x 40 mm | With symbols conforming to NF E 52-124 |           |           |           |           |           | With text |                            |            |
|---------------------|--|-----------|-----------|-----------|-----------|-----------|-----------|----------------------------|------------|
|                     |  |           |           |           |           |           |           |                            |            |
| <b>References</b>   | ZB2BY4901                              | ZB2BY4903 | ZB2BY4907 | ZB2BY4909 | ZB2BY4913 | ZB2BY4915 | ZB2BY4930 | ZB2BY2303                  | ZB2BY2304  |
|                     |  |           |           |           |           |           |           | blank                      |            |
| <b>References</b>   | ZB2BY2904                              | ZB2BY2906 | ZB2BY2910 | ZB2BY2912 | ZB2BY2916 | ZB2BY2918 | ZB2BY2931 | white or yellow background | ZB2BY1W140 |

(1) Trigger action mechanically latching Emergency stop pushbuttons conform to standards EN/IEC 60204-32, EN/ISO 13850, Machinery directive 2006/42/EC and standard EN/IEC 60947-5-5.

# Notes



1

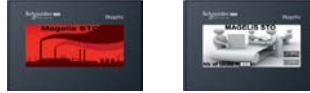

| Type                      |                              | Characteristics   |                  |                        |           |           |
|---------------------------|------------------------------|---|------------------|------------------------|-----------|-----------|
| Display                   | LCD screen size / Resolution | 3.4" / monochrome (200 X 80 pixels)   |                  |                        |           |           |
|                           | Type                         | Green, orange, red  | White, pink, red | Green, orange, red     |           |           |
| Functions                 | Representation of variables  | Alphanumeric, bitmap, bargraph, gauge, button, light, clock, flashing light, keypad                                     |                  |                        |           |           |
|                           | Curves / Alarm logs          | Yes, with log / Yes, incorporated   |                  |                        |           |           |
| Communication             | Serial link                  | 1 RJ45 (RS 232 - RS 485)  |                  | 1 Terminal Block RS232 |           |           |
|                           | Networks                     | –   | –                | –                      | Ethernet  | Ethernet  |
| Downloadable protocols    |                              | Mitsubishi (Melsec), Omron (Sysmac), Rockwell Automation (Allen Bradley), Siemens (Simatic), Uni-TE, Modbus, Modbus TCP |                  | Zelio                  |           |           |
| Development software      |                              | Vijeo Designer VJD●●●TG●V●●M (on Windows XP, Vista and 7) or Vijeo Designer Limited Edition                             |                  |                        |           |           |
| Dimensions W x D x H (mm) |                              | 116,5 x 38,5 x 77,5   |                  |                        |           |           |
| Compatibility with PLCs   |                              | «Twido, Modicon TSX Micro, Modicon Premium, Modicon Quantum, Modicon M340»  |                  | Zelio                  |           |           |
| «Compact Flash» card slot |                              | No  |                  |                        |           |           |
| USB port                  |                              | 1 Host type A + 1 Device type miniB   |                  |                        |           |           |
| Built-in Ethernet TCP/IP  |                              | No  |                  |                        | Yes       |           |
| Supply voltage            |                              | 24 VDC  |                  |                        |           |           |
| References                |                              | HMISTO511   | HMISTO512        | HMISTO501              | HMISTO531 | HMISTO532 |



| Type                      |                              | Characteristics   |                                |
|---------------------------|------------------------------|---|--------------------------------|
| Display                   | LCD screen size / Resolution | 3.5" / QVGA (320 X 240 pixels)  | 5.7" / QVGA (320 X 240 pixels) |
|                           | Type                         | TFT 65 536 colours  |                                |
| Functions                 | Representation of variables  | Alphanumeric, bitmap, bargraph, gauge, button, light, clock, flashing light, keypad                                     |                                |
|                           | Curves / Alarm logs          | Yes, with log / Yes, incorporated   |                                |
| Communication             | Serial link                  | 1 RJ45 (RS 232 - RS 485)  |                                |
|                           | Networks                     | Ethernet, IEEE 802.3, 10/100 BASE-T, RJ45   |                                |
| Downloadable protocols    |                              | Mitsubishi (Melsec), Omron (Sysmac), Rockwell Automation (Allen Bradley), Siemens (Simatic), Uni-TE, Modbus, Modbus TCP |                                |
| Development software      |                              | Vijeo Designer VJD●●●TG●V●●M (on Windows XP, Vista and 7) or Vijeo Designer Limited Edition                             |                                |
| Dimensions W x D x H (mm) |                              | Front: 98 x 16 x 81   | Front: 163 x 17.5 x 129.5      |
|                           |                              | Rear : 118 x 30 x 98  |                                |
| Compatibility with PLCs   |                              | Twido, Modicon TSX Micro, Modicon Premium, Modicon Quantum, Modicon M340  |                                |
| «Compact Flash» card slot |                              | No  |                                |
| USB port                  |                              | 1 Host type A + 1 Device type miniB   |                                |
| Built-in Ethernet TCP/IP  |                              | Yes   | Yes                            |
| Supply voltage            |                              | 24 VDC  |                                |
| References                |                              | HMISTU655   | HMISTU855                      |



## Small Panel Magelis XBT N with matrix, semi-graphic screen (1)



| Type                      |                             | Characteristics   |  |   |                |
|---------------------------|-----------------------------|---|--|---|----------------|
| Display                   | Capacity                    | 2 lines, 20 characters                                  | 1 to 4 lines, 5 to 20 characters                 |   |                |
|                           | Type                        | Back-lit LCD<br>green                                   | Back-lit LCD<br>3 colours<br>green, orange, red  |   |                |
| Data entry                |                             | Via keypad with 8 keys (4 customizable keys)            |  |   |                |
| Function                  | Representation of variables | Alphanumeric  | Alphanumeric, bargraph, curves, button and light |   |                |
|                           | Alarm log                   | No  | Yes  | Yes   | Yes            |
| Communication             | Serial link                 | 1 RJ45 (RS 232 - RS 485)                                |  | 1 Sub-D25 (RS 232 - RS 485) + 1 miniDin RS232 (2)   |                |
| Downloadable protocols    |                             | Uni-TE, Modbus Master                                   |  | Uni-TE, Modbus Master, Siemens, Rockwell, Omron, Mitsubishi, Zelio (2)                                |                |
| Development software      |                             | Vijeo Designer Lite (on Windows XP and Vista)           |  |   |                |
| Dimensions W x D x H (mm) |                             | 132 x 37 x 74   |  |   |                |
| Compatibility with PLCs   |                             | Twido, Modicon TSX Micro, Modicon Premium, Modicon M340 |  | Twido, Modicon TSX Micro, Modicon Premium, Modicon Quantum, Modicon Momentum, Modicon M340, Zelio (2) |                |
| Supply voltages           |                             | 5 VDC or PLC power supply                               |  | 24 VDC  |                |
| References                |                             | <b>XBTN200</b>  | <b>XBTN400</b>                                   | <b>XBTN410</b>  | <b>XBTN401</b> |

(1) Except XBTN200: alphanumeric screen.

(2) For XBTN401 only

## Magelis XBT N with matrix, semi-graphic screen, dedicated



| Type                      |                             | Characteristics                                  |
|---------------------------|-----------------------------|--|
| Display                   | Capacity                    | 1 to 4 lines, 5 to 20 characters                 |
|                           | Type                        | Back-lit LCD<br>green                            |
| Data entry                |                             | Via keypad with 8 keys                           |
| Function                  | Representation of variables | Alphanumeric, bargraph, curves, button and light |
|                           | Alarm log                   | Yes  |
| Communication             | Serial link                 | 1 Sub-D25  |
| Downloadable protocols    |                             | Modbus   |
| Development software      |                             | Vijeo Designer Lite (on Windows XP and Vista)    |
| Dimensions W x D x H (mm) |                             | 132 x 37 x 74                                    |
| Compatibility with PLCs   |                             | Motor starter<br>Tesy Model U                    |
| Supply voltages           |                             | 24 VDC   |
| References                |                             | <b>XBTNU400</b>                                  |

1



| Type                      |                              | Characteristics   |   |           |
|---------------------------|------------------------------|---|---|-----------|
| Display                   | LCD screen size / Resolution | 3.8" / QVGA   |   |           |
|                           | Type                         | STN monochrome, amber or red  | TFT 256 colour                              |           |
| Functions                 | Representation of variables  | Alphanumeric, bitmap, bargraph, gauge, button, light, clock, flashing light, keypad                                       |   |           |
|                           | Curves / Alarm logs          | Yes, with log / Yes, incorporated   |   |           |
| Communication             | Serial link                  | 1 RJ45 (RS 232 - RS 485)  |   |           |
|                           | Networks                     | –   | Ethernet, IEEE 802.3<br>10/100 BASE-T, RJ45 |           |
| Downloadable protocols    |                              | Mitsubishi (Melsec), Omron (Sysmac), Rockwell Automation (Allen Bradley), Siemens (Simatic)<br>Uni-TE, Modbus, Modbus TCP |   |           |
| Development software      |                              | Vijeo Designer VJD●●●TG●V●●M (on Windows XP, Vista and 7)   |   |           |
| Dimensions W x D x H (mm) |                              | 118 × 30 × 98   |   |           |
| Compatibility with PLCs   |                              | Twido, Modicon TSX Micro, Modicon Premium, Modicon Quantum, Modicon M340  |   |           |
| «Compact Flash» card slot |                              | No  |   |           |
| USB port Host type A      |                              | 1   | 1   | 1         |
| Built-in Ethernet TCP/IP  |                              | No  | Yes   |           |
| Supply voltage            |                              | 24 VDC  |   |           |
| References                |                              | XBTGT1105   | XBTGT1135                                   | XBTGT1335 |

## Magelis XBT GT with 5.7" touchscreen



| Type                      |                              | Characteristics  |   |                             |   |                           |   |           |
|---------------------------|------------------------------|--|---|-----------------------------|---|---------------------------|---|-----------|
| Display                   | LCD screen size / Resolution | 5.7" / QVGA  |   |                             |   |                           | 5.7" / VGA                                  |           |
|                           | Type                         | STN Monochrome<br>Blue<br>backlighting   | Black and White<br>backlighting             | STN, colour<br>4096 colours | TFT, colour<br>65536 colours<br>High brightness<br>backlighting |                           |   |           |
| Functions                 | Representation of variables  | Alphanumeric, bitmap, bargraph, gauge, button, light, clock, flashing light, keypad  |   |                             |   |                           |   |           |
|                           | Curves / Alarm logs          | Yes, with log / Yes, incorporated  |   |                             |   |                           |   |           |
| Communication             | Serial link                  | 1 Sub-D9 (RS 232/RS 422 - RS 485) + 1 RJ45 (RS 485)  |   |                             |   |                           |   |           |
|                           | Networks                     | –  | Ethernet, IEEE 802.3<br>10/100 BASE-T, RJ45 | –                           | Ethernet, IEEE 802.3<br>10/100 BASE-T, RJ45                     | Ethernet<br>10/100 BASE-T | Ethernet, IEEE 802.3<br>10/100 BASE-T, RJ45 |           |
| Downloadable protocols    |                              | Mitsubishi (Melsec), Omron (Sysmac), Rockwell Automation (Allen Bradley), Siemens (Simatic)<br>Uni-TE, Modbus, Modbus TCP/IP |   |                             |   |                           |   |           |
| Development software      |                              | Vijeo Designer VJD●●●TG●V●●M (on Windows XP, Vista and 7)  |   |                             |   |                           |   |           |
| Dimensions W x D x H (mm) |                              | 167.5 x 60 x 135   |   |                             |   |                           |   |           |
| Compatibility with PLCs   |                              | Twido, Modicon TSX Micro, Modicon Premium, Modicon Quantum, Modicon M340, Modicon Momentum                                   |   |                             |   |                           |   |           |
| «Compact Flash» card slot |                              | No   | Yes   |                             |   |                           |   |           |
| USB port Host type A      |                              | 1  |   |                             |   |                           | 2   |           |
| Video in                  |                              | No   |   |                             |   |                           |   |           |
| Built-in Ethernet TCP/IP  |                              | No   | No  | Yes                         | No  | Yes                       | Yes   | Yes       |
| Supply voltage            |                              | 24 VDC   |   |                             |   |                           |   |           |
| References                |                              | XBTGT2110  | XBTGT2120                                   | XBTGT2130                   | XBTGT2220   | XBTGT2330                 | XBTGT2930                                   | XBTGT2430 |



| Type                      |                              | Characteristics  |           |           |                |           |           |                |
|---------------------------|------------------------------|--|-----------|-----------|----------------|-----------|-----------|----------------|
| Display                   | LCD screen size / Resolution | 7.5" / VGA   |           |           | 10.4" / VGA    |           |           | 10.4" / SVGA   |
|                           | Type (colour)                | STN  | TFT       | TFT       | STN            | TFT       | TFT       | TFT            |
|                           | Number of colours            | 4096   | 65536     | 65536     | 4096           | 65536     | 65536     | 65536          |
| Functions                 | Representation of variables  | Alphanumeric, bitmap, bargraph, gauge, button, light, clock, flashing light, keypad  |           |           |                |           |           |                |
|                           | Curves / Alarm logs          | Yes, with log / Yes, incorporated  |           |           |                |           |           |                |
| Communication             | Serial link                  | 1 Sub-D9 (RS 232/RS 422 - RS 485) + 1 RJ45 (RS 485)  |           |           |                |           |           |                |
|                           | Networks                     | Ethernet, IEEE 802.3 10/100 BASE-T, RJ 45  |           |           |                |           |           |                |
| Downloadable protocols    |                              | Mitsubishi (Melsec), Omron (Sysmac), Rockwell Automation (Allen Bradley), Siemens (Simatic)<br>Uni-TE, Modbus, Modbus TCP/IP |           |           |                |           |           |                |
| Development software      |                              | Vijeo Designer VJD●●●TG●V●●M (on Windows XP, Vista and 7)  |           |           |                |           |           |                |
| Dimensions W x D x H (mm) |                              | 215 x 60 x 170   |           |           | 313 x 56 x 239 |           |           | 271 x 57 x 213 |
| Compatibility with PLCs   |                              | Twido, Modicon TSX Micro, Modicon Premium, Modicon Quantum, Modicon M340   |           |           |                |           |           |                |
| «Compact Flash» card slot |                              | Yes  |           |           |                |           |           |                |
| USB port Host type A      |                              | 1  | 1         | 1         | 2              | 2         | 2         | 2              |
| Video in                  |                              | No   | No        | Yes       | No             | No        | Yes       | No             |
| Built-in Ethernet TCP/IP  |                              | Yes  |           |           |                |           |           |                |
| Supply voltage            |                              | 24 VDC   |           |           |                |           |           |                |
| References                |                              | XBTGT4230  | XBTGT4330 | XBTGT4340 | XBTGT5230      | XBTGT5330 | XBTGT5340 | XBTGT5430      |

## Magelis XBT GT with 12.1" and 15" touchscreen



| Type                      |                              | Characteristics  |           |                |
|---------------------------|------------------------------|--|-----------|----------------|
| Display                   | LCD screen size / Resolution | 12,1" / SVGA   |           | 15" / XGA      |
|                           | Type (colour)                | TFT  |           | TFT            |
|                           | Number of colours            | 65536  |           | 65536          |
| Functions                 | Representation of variables  | Alphanumeric, bitmap, bargraph, gauge, button, light, clock, flashing light, keypad  |           |                |
|                           | Curves / Alarm logs          | Yes, with log / Yes, incorporated  |           |                |
| Communication             | Serial link                  | 1 Sub-D9 (RS 232/RS 422 - RS 485) + 1 RJ45 (RS 485)  |           |                |
|                           | Networks                     | Ethernet, IEEE 802.3 10/100 BASE-T, RJ 45BASE-T, RJ 45   |           |                |
| Downloadable protocols    |                              | Mitsubishi (Melsec), Omron (Sysmac), Rockwell Automation (Allen Bradley), Siemens (Simatic)<br>Uni-TE, Modbus, Modbus TCP/IP |           |                |
| Development software      |                              | Vijeo Designer VJD●●●TG●V●●M (on Windows XP, Vista and 7)  |           |                |
| Dimensions W x D x H (mm) |                              | 313 x 56 x 239   |           | 395 x 60 x 294 |
| Compatibility with PLCs   |                              | Twido, Modicon TSX Micro, Modicon Premium, Modicon Quantum, Modicon M340   |           |                |
| «Compact Flash» card slot |                              | Yes  |           |                |
| USB port Host type A      |                              | 2  |           |                |
| Video in                  |                              | No   | Yes       | Yes            |
| Built-in Ethernet TCP/IP  |                              | Yes  |           |                |
| Supply voltage            |                              | 24 VDC   |           |                |
| References                |                              | XBTGT6330  | XBTGT6340 | XBTGT7340      |

1



| Type                      |  | Characteristics   |                             |              |
|---------------------------|--|---|-----------------------------|--------------|
| Display                   | Screen size / Resolution   | 5.7" / QVGA   |                             | 10.4" / VGA  |
|                           | Type   | STN monochrome<br>black and white   | TFT Colour<br>65536 colours |              |
| Data entry                | Soft function keys with LED  | 14  |                             | 18           |
|                           | Static function keys with LED  | 10 + legends  |                             | 12 + legends |
|                           | Service keys / Alphanumeric keys   | 8 / 12  |                             |              |
|                           | Touchscreen and industrial pointer   | Yes   |                             |              |
| Functions                 | Representation of variables  | Alphanumeric, bitmap, bargraph, gauge, button, light, clock, flashing light, keypad |                             |              |
|                           | Curves   | Yes, with log   |                             |              |
|                           | Alarm logs   | Yes   |                             |              |
| Communication             | Serial link  | 1 Sub-D9 (RS 232/RS 422 - RS 485) + 1 RJ45 (RS 485)                                 |                             |              |
|                           | Networks   | –   Ethernet, IEEE 802.3 10/100 BASE-T, RJ 45                                       |                             |              |
| Downloadable protocols    | Mitsubishi (Melsec), Omron (Sysmac), Rockwell Automation (Allen Bradley), Siemens (Simatic)<br>Uni-TE, Modbus, Modbus TCP/IP |   |                             |              |
| Development software      | Vijeo Designer VJD●●●TG●V●●M (on Windows XP, Vista and 7)  |   |                             |              |
| «Compact Flash» card slot | Yes  |   |                             |              |
| Dimensions W x D x H (mm) | 220.3 x 88 x 265   | 296 x 91 x 332  | 197 x 92.6 x 147            |              |
| Compatibility with PLCs   | Twido, Modicon TSX Micro, Modicon Premium, Modicon Quantum, Modicon M340   |   |                             |              |
| USB port                  | 1  | 1   | 2                           |              |
| Video in                  | No   | No  | No                          |              |
| Built-in Ethernet TCP/IP  | No   | Yes   |                             |              |
| Supply voltage            | 24 VDC   |   |                             |              |
| References                | XBTGK2120  | XBTGK2330   | XBTGK5330                   |              |

## Magelis XBT GTW with 8.4", 12", 15" touchscreen



| Type                   |  | Characteristics                         |  |  |
|------------------------|--|---|--|--|
| Pre-installed Software | OS: Windows XP Embedded, Internet Explorer, Office & Acrobat Reader, .NET, Vijeo Designer Run Time unlimited |   |  |  |
|                        | –  | Vijeo Citect Web Client                 |  |  |
| Touchscreen            | 8.4" LCD TFT   | 12" LCD TFT                             | 15" LCD TFT  |  |
| Resolution             | SVGA 800 x 600   | SVGA 800 x 600                          | XGA 1024 x 768   |  |
| Front panel ports      | –  | 1 x USB                                 | 1 x USB  |  |
| Processor              | Celeron M @ 600 MHz  | Celeron M @ 1GHz                        | Celeron M@1GHz   |  |
| RAM                    | 512MB ▶ 1024MB   | 512MB ▶ 1024MB                          | 1024MB   |  |
| Storage                | CF 2GB expandable to 4GB   | CF 2GB expandable to 4GB                | CF 4GB   |  |
| Extension              | –  | 1 x PCMCIA slot<br>(for 1 type II card) | 1 PCMCIA slot (for 1 type III card<br>or 2 type I cards) |  |
| Ethernet ports         | 2 (10/100/1G + 10/100)   | 2 (10/100/1G + 10/100)                  | 2 (10/100/1G + 10/100)                                   |  |
| Ports I/O              | 4 x USB, 2 x RS232   | 4 x USB, 1 x RS232                      | 4 x USB, 2 x RS232                                       |  |
| Power supply           | 24 VDC   |   |  |  |
| Dimension              | 230 x 65 x 177   | 313 x 60 x 239                          | 395 x 65 x 294   |  |
| References             | XBTGTW450  | XBTGTW652                               | HMIGTW7353   |  |



| Type                      |  | Characteristics   |                  |
|---------------------------|--|---|------------------|
| <b>+ Screen</b>           |  |   |                  |
| Display                   | screen size / Resolution   | 5,7" / VGA  |                  |
|                           | Type (colour)  | TFT   |                  |
|                           | Number of colours  | 65 536  |                  |
| Data entry                | Function keys  | 11 + label  |                  |
|                           | Operaton key   | 1 with LED (validation touchscreen)   |                  |
| Safety components         | Key Switch   | Yes for ON/OFF  |                  |
|                           | 3 positions Enable switch  | Yes, OK signal in intermediate position only  |                  |
|                           | Emergency stop   | Yes, red with 2 safe contacts and one auxiliary contact                             |                  |
| Functions                 | Representation of variables  | Alphanumeric, bitmap, bargraph, gauge, button, light, clock, flashing light, keypad |                  |
|                           | Curves / Alarm historic  | Yes, with log / Yes, incorporated   |                  |
| Connection                | 32-pins connector (communication, alimentation, I/O)   |   |                  |
| Downloadable protocols    | Mitsubishi (Melsec), Omron (Sysmac), Rockwell Automation (Allen Bradley), Siemens (Simatic)<br>Uni-TE, Modbus, Modbus TCP/IP |   |                  |
| Development software      | Vijeo Designer VJD●●●TG●V●●M (on Windows XP, Vista and 7)  |   |                  |
| «Compact Flash» card slot | Yes  |   |                  |
| Dimensions W x D x H (mm) | 224 x 174 x 87.1   |   |                  |
| USB port                  | 1  |   |                  |
| Supply voltage            | 24 VDC   |   |                  |
| Reference                 | <b>XBT GH2460</b>  |   |                  |
| <b>+ Cable interface</b>  |  | <b>connection with junction box</b>   |                  |
| Type of connector         | 2 x 32-pins speed connectors   |   |                  |
| Length                    | 3 m  | 5 m   | 10 m             |
| Reference                 | <b>XBTZGHL3</b>  | <b>XBTZGHL5</b>   | <b>XBTZGHL10</b> |
| <b>+ Junction box</b>     |  | <b>connection with PLCs</b>   |                  |
| Communcation              | Serial link  | 1 SubD9 (RS232 / RS422 - RS 425)  |                  |
|                           | Network  | 1 Ethernet RJ45 IEEE 802.3 10/100 T-BASE,   |                  |
| Connection                | 32 pins connector  | Interface cable 3 or 10 m   |                  |
|                           | 24 pins screw terminals blocks   | For alimentation 24 VDC, state of I/O safety components                             |                  |
| Reference                 | <b>XBTZGJBOX</b>   |   |                  |

A large number of accessories (cables, memory cards, protective sheets, etc ...) is available for the Advanced panels range.

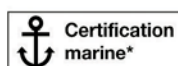

1



| Type                      |                              | Characteristics   |                                    |   |
|---------------------------|------------------------------|---|------------------------------------|---|
| Display                   | LCD screen size / Resolution | 3,8" / QVGA   | 5,7" / QVGA                        |   |
|                           | Type                         | STN monochrome, amber or red  | STN monochrome, gray               | STN 4096 colours                            |
| Functions                 | Representation of variables  | Alphanumeric, bitmap, bargraph, gauge, button, light, clock, flashing light, keypad                                       |                                    |   |
|                           | Curves / Alarm logs          | Yes, with log / Yes, incorporated   |                                    |   |
|                           | Control                      | 5 languages IEC   |                                    |   |
| Communication             | Serial link                  | –   | 1 Sub9 (RS 232/RS 422 - RS 485)    |   |
|                           | Networks                     | –   | –                                  | Ethernet, IEEE 802.3<br>10/100 BASE-T, RJ45 |
| Downloadable protocols    |                              | Mitsubishi (Melsec), Omron (Sysmac), Rockwell Automation (Allen Bradley), Siemens (Sematic)<br>Uni-TE, Modbus, Modbus TCP |                                    |   |
| Development software      |                              | SoMachine (on Windows XP and Vista)   |                                    |   |
| Dimensions W x D x H (mm) |                              | 130 x 76 x 104  | 207 x 76 x 157                     |   |
| Compatibility with PLCs   |                              | Twido, Modicon TSX Micro, Modicon Premium, Modicon Quantum, Modicon M340  |                                    |   |
| «Compact Flash» card slot |                              | No  |                                    |   |
| USB port Host type A      |                              | 1   | 1                                  | 1   |
| Built-in Ethernet TCP/IP  |                              | No  | No                                 | Yes   |
| Integrated I/O            |                              | 12I/6O 24 VDC   | 16I/16O 24 VDC                     |   |
| Extensions                |                              | 2 modules TM2<br>or CANopen module  | 3 modules TM2<br>or CANopen module |   |
| Supply voltage            |                              | 24 VDC  |                                    |   |
| References                | Source Output                | <b>XBTGC1100T</b>   | <b>XBTGC2120T</b>                  | <b>XBTGC2230T</b>                           |
|                           | Sink Output                  | <b>XBTGC1100U</b>   | <b>XBTGC2120U</b>                  | <b>XBTGC2230U</b>                           |

## Extensions

| Type of module  | CANopen Master                                    |  |  |
|-----------------|---|--|--|
| Characteristics | Class M10 limited 16 slaves, Standard DS301 V4.O2 |  |  |
| References      | <b>XBTZGCCAN</b>                                  |  |  |

| Type of module  | Digitals Inputs / Outputs      |                                 |                       |                       |                                 |  |   |
|-----------------|--------------------------------|---------------------------------|-----------------------|-----------------------|---------------------------------|--|---|
| Characteristics | 8I<br>24 VDC<br>Screw terminal | 16I<br>24 VDC<br>Screw terminal | 16I<br>24 VDC<br>HE10 | 32I<br>24 VDC<br>HE10 | 8I<br>120 VAC<br>Screw terminal | 4I 24 VDC<br>4O Relays<br>Screw terminal | 16I 24 VDC<br>8O Relays<br>Screw terminal |
| References      | <b>TM2DDI8DT</b>               | <b>TM2DDI16DT</b>               | <b>TM2DDI16DK</b>     | <b>TM2DDI32DK</b>     | <b>TM2DAI8DT</b>                | <b>TM2DMM8DRT</b>                        | <b>TM2DMM24DRF</b>                        |

| Type of module  | Digitals Inputs / Outputs                 |                                  |                                  |   |  |                   |
|-----------------|---|----------------------------------|----------------------------------|---|--|-------------------|
| Characteristics | 8O Transistor<br>24 VDC<br>Screw terminal | 16O Transistor<br>24 VDC<br>HE10 | 32O Transistor<br>24 VDC<br>HE10 | 8O Relays<br>230 VAC 30 VDC<br>Screw terminal | 16O Relays<br>230 VAC 30 VDC<br>Screw terminal | –                 |
| References      | Source Output                             | <b>TM2DD08TT</b>                 | <b>TM2DD016TK</b>                | <b>TM2DD032TK</b>                             | <b>TM2DRA8RT</b>                               | <b>TM2DRA16RT</b> |
|                 | Sink Output                               | <b>TM2DD08UT</b>                 | <b>TM2DD016UK</b>                | <b>TM2DD032UK</b>                             | –  | –                 |

| Type of module  | Analog Inputs / Outputs |                  |                                   |                    |                                       |                  |
|-----------------|-------------------------|------------------|-----------------------------------|--------------------|---------------------------------------|------------------|
| Characteristics | 2I Current/Voltage      | 2I Thermocouple  | 4I Current/Voltage<br>Temperature | 8I Current/Voltage | 8I Temperature                        | 8I PTC           |
| References      | <b>TM2AMI2HT</b>        | <b>TM2AMI2LT</b> | <b>TM2AMI4LT</b>                  | <b>TM2AMI8HT</b>   | <b>TM2ARI8LRJ</b><br><b>TM2ARI8LT</b> | <b>TM2ARI8HT</b> |

| Type of module  | Analog Inputs / Outputs |                  |  |                                      |  |   |
|-----------------|-------------------------|------------------|--|--------------------------------------|--|---|
| Characteristics | 1O Current/Voltage      | 2O Voltage       | 2I Current/Voltage<br>1O Current/Voltage | 2I Temperature<br>1O Current/Voltage | 4I Current/Voltage<br>2O Current/Voltage | – |
| References      | <b>TM2AMO1HT</b>        | <b>TM2AVO2HT</b> | <b>TM2AMM3HT</b>                         | <b>TM2ALM3LT</b>                     | <b>TM2AMM6HT</b>                         | – |



| Type                      |   | Characteristics   |  |
|---------------------------|---|---|--|
| Display                   | LCD screen size / Resolution  | 5.7" / QVGA to 10,4" / VGA  | «5.7" (QVGA/VGA), 7.5" (VGA), 10.4" (VGA/SVGA), 12.1" (SVGA), 15" (XGA)» |
|                           | Type  | STN monochrome or TFT color   | STN monochrome, STN 4096 colors, TFT 65000 colors                        |
| Functions                 | Representation of variables   | Alphanumeric, bitmap, bargraph, gauge, button, light, clock, flashing light, keypad |  |
|                           | Curves / Alarm logs   | Yes, with log / Yes, incorporated   |  |
|                           | Control   | 5 languages IEC   |  |
| Communication             | Serial link   | 1 RJ45 (RS 485) + 1 Sub9 (RS 232/RS 422 - RS 485)                                   |  |
|                           | Networks  | Ethernet, IEEE 802.3 10/100 BASE-T, RJ45 depending on model                         |  |
| Downloadable protocols    | Mitsubishi (Melsec), Omron (Sysmac), Rockwell Automation (Allen Bradley), Siemens (Simatic), Uni-TE, Modbus, Modbus TCP |   |  |
| Development software      | SoMachine (under Windows XP and Vista)  |   |  |
| Dimensions W x D x H (mm) | Depending on model  |   |  |
| Compatibility with PLCs   | Twido, Modicon TSX Micro, Modicon Premium, Modicon Quantum, Modicon M340  |   |  |
| «Compact Flash» card slot | Yes   |   |  |
| USB port                  | 1 or 2  |   |  |
| Built-in Ethernet TCP/IP  | Depending on model  |   |  |
| Built-in I/O              | No  |   |  |
| Extensions                | CANopen module mandatory  |   |  |
| Supply voltage            | 24 VDC  |   |  |
| References                | XBTGK2●/53 (1)  |   | XBTGT2●/4●/5●/63/73 (2)  |

(1) for detailed references, see p37

(2) for detailed references, see p35-36

## Control extension

| Type of module  | CANopen Master                                    |
|-----------------|---|
| Characteristics | Class M10 limited 16 slaves, Standard DS301 V4.02 |
| Reference       | XBTZGCANM   |



1

### Box PC Universal

|   |  |                             |  |                                |                     |
|---|--|-----------------------------|--|--------------------------------|---------------------|
| <b>CPU &amp; RAM types</b>                | Atom N270 1,6 Ghz Fanless with DDR2 RAM  |                             |  |                                |                     |
| <b>PCI Slots</b>                          | 1 PCI  |                             | 2 (1 PCI + 1 PCIe)   |                                |                     |
| <b>Operating System</b>                   | WES 2009   |                             | XP PRO SP3   |                                |                     |
| <b>Storage</b>                            | CF =< 4Gb (SLC)  | Flash Disk =<32Go (SSD SLC) | HDD =<250Go  | Flash Disk =<32Go (SSD SLC)    | HDD =<250Go         |
| <b>Integrated DVD-RW</b>                  | -  |                             |  |                                | 1                   |
| <b>Slide-in</b>                           | 1 for storage  |                             | 1 for storage + 1 for DVD-RW (or for storage with adapter) |                                |                     |
| <b>Power supply</b>                       | 24V DC   |                             |  |                                |                     |
| <b>Integrated ports</b>                   | 2 Ethernet Gigabit, 5 USB, 2 RS232, 1 DVI  |                             |  |                                |                     |
| <b>Optional</b>                           | Battery-backup*, additional RS232/485 port, additional DVI for Box PC 2 slots, redundant RAID HDD by PCI |                             |  |                                |                     |
| <b>Overall dimensions (WxHxD in mm)</b>   | 82x270x251   |                             | 121x270x251  |                                |                     |
| <b>Industrial Certifications</b>          | CE, UL508 industrial control, cUL, ANSI/ISA 12.12.01 for hazardous locations, Gost, C-Tick               |                             |  |                                |                     |
| <b>Marine certification</b>               | Germany Loyd with power filter   |                             | -  | Germany Loyd with power filter | -                   |
| <b>Vijeo Designer</b>                     | Vijeo Designer Run Time demo. Unlimited licence to be ordered separatly (VJDSNRTMPC)                     |                             |  |                                |                     |
| <b>1GB RAM</b>                            | <b>HMIBUCND1E01</b>  | <b>HMIBUFND1P01</b>         | <b>HMIBUHND1P01</b>  | <b>HMIBUFND2P01</b>            | <b>HMIBUHDD2P01</b> |
| <b>Vijeo Citect Full 500 I/O, 2Gb RAM</b> | -  | <b>HMIBUFND17F1</b>         |  | <b>HMIBUFND2PF1</b>            | -                   |

Configured iPC service

\*Other configurations on request. Please consult our Customer Care Center.



### Box PC Performance

|   |  |                     |                             |                     |  |
|---|--|---------------------|-----------------------------|---------------------|--|
| <b>CPU &amp; RAM types</b>                | Core 2 Duo 2,26 Ghz Fan, with DDR3 RAM   |                     |                             |                     |  |
| <b>PCI Slots</b>                          | 2 (1 PCI + 1 PCIe)   |                     | 5 (2 PCI + 3 PCIe)          |                     |  |
| <b>Operating System</b>                   | Windows 7 64 bits Ultimate   |                     |                             |                     |  |
| <b>Storage</b>                            | Flash Disk =<32Go (SSD SLC)  | HDD =<250Go         | Flash Disk =<32Go (SSD SLC) | HDD =<250Go         |  |
| <b>Integrated DVD-RW</b>                  | 1  |                     |                             |                     |  |
| <b>Slide-in</b>                           | 1 for storage + 1 for DVD-RW (or for storage with adapter)                                 |                     |                             |                     |  |
| <b>Power supply</b>                       | 24V DC   |                     |                             |                     |  |
| <b>Integrated ports</b>                   | 2 Ethernet Gigabit, 5 USB, 2 RS232, 1 DVI  |                     |                             |                     |  |
| <b>Optional</b>                           | Battery-backup*, additional RS232/485 port, additional DVI, redundant RAID HDD by PCI      |                     |                             |                     |  |
| <b>Overall dimensions (WxHxD in mm)</b>   | 121x270x251  |                     | 217x270x251                 |                     |  |
| <b>Industrial Certifications</b>          | CE, UL508 industrial control, cUL, ANSI/ISA 12.12.01 for hazardous locations, Gost, C-Tick |                     |                             |                     |  |
| <b>Marine certification</b>               | -  |                     |                             |                     |  |
| <b>Vijeo Designer</b>                     | Vijeo Designer Run Time demo. Unlimited licence to be ordered separatly (VJDSNRTMPC)       |                     |                             |                     |  |
| <b>2Gb RAM</b>                            | <b>HMIBPFDD2701</b>  | <b>HMIBPHDD2701</b> | <b>HMIBPFDD5701</b>         | <b>HMIBPHDD5701</b> |  |
| <b>Vijeo Citect Full 500 I/O, 4Gb RAM</b> | <b>HMIBPFDD27F1</b>  | -                   | <b>HMIBPFDD57F1</b>         | -                   |  |

Configured iPC service

\*Other configurations on request. Please consult our Customer Care Center.





|                           |    | 15" touch & keypad   | 15" touch            | 15" Touch DC         | 19" touch            |
|---------------------------|----|----------------------|----------------------|----------------------|----------------------|
| Touchscreen               |    | 15" LCD TFT          | 15" LCD TFT          | 15" LCD TFT          | 19" LCD TFT          |
| Resolution                |    | XGA 1024x768         | XGA 1024x768         | XGA 1024x768         | SXGA 1280x1024       |
| Front side port           |    | 1 x USB              | 1 x USB              | 2 x USB              | 1 x USB              |
| Video ports               |    | 1 x VGA & 1 x DVI    | 1 x VGA & 1 x DVI    | 2 x VGA & 1 x DVI    | 1 x VGA & 1 x DVI    |
| Touchscreen ports         |    | 1 x USB & 1 x RS 232 | 1 x USB & 1 x RS 232 | 2 x USB & 1 x RS 232 | 1 x USB & 1 x RS 232 |
| Certification             |    | UL508, CSA           | UL508, CSA           | UL508, CSA           | UL508, CSA           |
| Dimensions W x D x H (mm) |    | 483 x 65 x 365       | 395 x 60 x 294       | 395 x 60 x 294       | 460 x 65 x 390       |
| References                | AC | <b>MPCNB50NAN00N</b> | <b>MPCYT50NAN00N</b> | –                    | <b>MPCYT90NAN00N</b> |
|                           | DC | –                    | –                    | <b>HMIDID7DT0</b>    | –                    |

## PC Panel Magelis Panel PC 10", 15"



|                                  | Optimum Panel PC 10"   | Optimum Panel PC 15"            |
|----------------------------------|--|---------------------------------|
| Touch screen                     | 10" LCD TFT with LED, IP65   | 15" LCD TFT with LED, IP65      |
| Résolution                       | SVGA 800x600, 16 Million colors  | XGA 1024x768, 16 Million colors |
| CPU                              | Atom Z510 1,1 Ghz Fanless  |                                 |
| Operating System                 | WES 2009   |                                 |
| RAM                              | 1 GB DDR2  |                                 |
| OS storage                       | CF 2Gb (SLC)   |                                 |
| User storage                     | SD card  |                                 |
| Power supply                     | 24V DC   |                                 |
| Intergated ports                 | 2 x Ethernet Gibabit, 1 USB front + 2, 1 RS232   |                                 |
| Overall dimensions (WxHxD in mm) | 323x260x72   | 402x301x72                      |
| Industrial Certifications        | CE, UL508 industrial control, cUL, ANSI/ISA 12.12.01 for hazardous locations, Gost, C-Tick,  |                                 |
| Marine certification             | Germany Loyd with power filter   |                                 |
| Software                         | Office & PDF readers, Internet browser, .Net 3.5, Vijeo Designer RT demo (Unlimited licence to be ordered separatly VJDSNRTMPC), Vijeo Citect web client |                                 |
| Part number                      | <b>HMIPWC 5D0E01</b>   | <b>HMIPWC 7D0E01</b>            |
| Part Number GTW                  | <b>HMIGTW 5354</b>   | <b>HMIGTW 7354</b>              |



#### Panel PC Universal 15"

|   |   |                             |                     |                             |  |
|---|---|-----------------------------|---------------------|-----------------------------|--|
| <b>Touch screen</b>                             | 15" LCD TFT with LED backlight, IP65, same cut-out than legacy                              |                             |                     |                             |  |
| <b>Résolution</b>                               | XGA 1024x768, 16 Million colors   |                             |                     |                             |  |
| <b>CPU &amp; RAM types</b>                      | Atom N270 1,6 Ghz Fanless with DDR2 RAM   |                             |                     |                             |  |
| <b>PCI Slots</b>                                | -   |                             |                     |                             | 2 (1 PCI + 1 PCIe)   |
| <b>Operating System</b>                         | WES 2009  | XP PRO SP3                  |                     |                             |  |
| <b>Storage</b>                                  | CF =< 4Gb (SLC)   | Flash Disk =<32Go (SSD SLC) | HDD =<250Go         | Flash Disk =<32Go (SSD SLC) | HDD =<250Go  |
| <b>Integrated DVD-RW</b>                        | -   |                             |                     |                             | 1  |
| <b>Slide-in</b>                                 | 1 for storage   |                             |                     |                             | 1 for storage + 1 for DVD-RW (or for storage with adapter) |
| <b>Integrated ports</b>                         | 2 Ethernet Gigabit, 1 front USB + 4 USB, 2 RS232, 1 DVI                                     |                             |                     |                             |  |
| <b>Optional</b>                                 | Battery-backup*, additional RS232/485 port*   |                             |                     |                             | + redundant RAID HDD by PCI                                |
| <b>Overall dimensions (WxHxD in mm)</b>         | 402x301x104   |                             |                     |                             | 402x301x153  |
| <b>Industrial Certifications</b>                | CE, UL508 industrial control, cUL, ANSI/ISA 12.12.01 for hazardous locations, Gost, C-Tick, |                             |                     |                             |  |
| <b>Marine certification</b>                     | Germany Loyd with power filter  | -                           |                     |                             |  |
| <b>Vijeo Designer</b>                           | Vijeo Designer Run Time demo. Unlimited licence to be ordered separately (VJDSNRTMPC)       |                             |                     |                             |  |
| <b>1GB RAM - DC power supply</b>                | <b>HMIPUC7D0E01</b>   | <b>HMIPUF7D0P01</b>         | <b>HMIPUH7D0P01</b> | -                           | <b>HMIPUH7D2P01</b>  |
| <b>Vijeo Citect Lite 1200 I/O, 2Gb RAM - DC</b> | -   | <b>HMIPUF7D0PL1</b>         | -                   | -                           | -  |
| <b>1Gb RAM - AC power supply</b>                | -   | <b>HMIPUF7A0P01</b>         | <b>HMIPUH7A0P01</b> | <b>HMIPUF7A2P01</b>         | <b>HMIPUH7A2P01</b>  |
| <b>Vijeo Citect Full 500 I/O, 2Gb RAM - AC</b>  | -   | -                           | -                   | <b>HMIPUF7A2PF1</b>         | -  |

Configured iPC service

\*Other configurations on request. Please consult our Customer Care Center.



#### Panel PC Performance 15"

|   |   |                     |                             |                     |  |
|---|---|---------------------|-----------------------------|---------------------|--|
| <b>Touch screen</b>                             | 15" LCD TFT with LED backlight, IP65, same cut-out than legacy                              |                     |                             |                     |  |
| <b>Résolution</b>                               | XGA 1024x768, 16 Million colors   |                     |                             |                     |  |
| <b>CPU &amp; RAM types</b>                      | Core 2 Duo 2,26 Ghz Fan, with DDR3 RAM  |                     |                             |                     |  |
| <b>PCI Slots</b>                                | -   |                     |                             |                     | 2 (1 PCI + 1 PCIe)   |
| <b>Operating System</b>                         | Windows 7 64 bits Ultimate  |                     |                             |                     |  |
| <b>Storage</b>                                  | Flash Disk =<32Go (SSD SLC)   | HDD =<250Go         | Flash Disk =<32Go (SSD SLC) | HDD =<250Go         |  |
| <b>Integrated DVD-RW</b>                        | -   |                     |                             |                     | 1  |
| <b>Slide-in</b>                                 | 1 for storage   |                     |                             |                     | 1 for storage + 1 for DVD-RW (or for storage with adapter) |
| <b>Integrated ports</b>                         | 2 Ethernet Gigabit, 1 front USB + 4 USB, 2 RS232, 1 DVI                                     |                     |                             |                     |  |
| <b>Optional</b>                                 | Battery-backup*, add. RS232/485 port*   |                     |                             |                     | + redundant RAID HDD by PCI                                |
| <b>Overall dimensions (WxHxD in mm)</b>         | 402x301x118   |                     |                             |                     | 402x301x168  |
| <b>Industrial Certifications</b>                | CE, UL508 industrial control, cUL, ANSI/ISA 12.12.01 for hazardous locations, Gost, C-Tick, |                     |                             |                     |  |
| <b>Vijeo Designer</b>                           | Vijeo Designer Run Time demo. Unlimited licence to be ordered separately (VJDSNRTMPC)       |                     |                             |                     |  |
| <b>2Gb RAM - DC power supply</b>                | <b>HMIPPF7D0701</b>   | <b>HMIPPH7D0701</b> | -                           | <b>HMIPPH7D2701</b> |  |
| <b>2Gb RAM - Battery back-up interface - DC</b> | -   | -                   | -                           | <b>HMIPPH7B2701</b> |  |
| <b>Vijeo Citect Full 500 I/O, 4Gb RAM - DC</b>  | <b>HMIPPF7D07F1</b>   | -                   | -                           | -                   |  |
| <b>2Gb RAM - AC power supply</b>                | -   | <b>HMIPPH7D0701</b> | <b>HMIPPF7A2701</b>         | <b>HMIPPH7A2701</b> |  |
| <b>Vijeo Citect Full 500 I/O, 4Gb RAM - AC</b>  | -   | -                   | <b>HMIPPF7A27F1</b>         | -                   |  |

Configured iPC service

\*Other configurations on request. Please consult our Customer Care Center.



### Panel PC Universal 19"

|  |                             |                     |  |                     |
|--|-----------------------------|---------------------|--|---------------------|
| 19" LCD TFT with LED backlight, IP65   |                             |                     |  |                     |
| SXGA 1280x1024, 16 Million colors  |                             |                     |  |                     |
| Atom N270 1,6 Ghz Fanless with DDR2 RAM  |                             |                     |  |                     |
| –  |                             |                     |  | 2 (1 PCI + 1 PCIe)  |
| WES 2009   | XP PRO SP3                  |                     |  |                     |
| CF =< 4Gb (SLC)  | Flash Disk =<32Go (SSD SLC) | HDD =<250Go         | Flash Disk =<32Go (SSD SLC)                                | HDD =<250Go         |
| –  |                             |                     | 1  |                     |
| 1 for storage  |                             |                     | 1 for storage + 1 for DVD-RW (or for storage with adapter) |                     |
| 2 Ethernet Gibabit, 1 front USB + 4 USB, 2 RS232, 1 DVI  |                             |                     |  |                     |
| Battery-backup*, additional RS232/485 port*  |                             |                     | + redundant RAID HDD by PCI                                |                     |
| 480x380x114  |                             |                     | 480x380x153  |                     |
| CE, UL508 industrial control, cUL, ANSI/ISA 12.12.01 for hazardous locations, Gost, C-Tick, Germany Loyd with power filter |                             |                     |  |                     |
| Vijeo Designer Run Time demo. Unlimited licence to be ordered separately (VJDSNRTMPC)                                      |                             |                     |  |                     |
| <b>HMIPUC9D0E01</b>  | <b>HMIPUF9D0P01</b>         | <b>HMIPUH9D0P01</b> | –  | <b>HMIPUH9D2P01</b> |
| –  | <b>HMIPUF9D0PL1</b>         | –                   | –  | –                   |
| –  | –                           | <b>HMIPUH9A0P01</b> | <b>HMIPUF9A2P01</b>  | <b>HMIPUH9A2P01</b> |
| –  | –                           | –                   | <b>HMIPUF9A2PF1</b>  | –                   |

\*Other configurations on request. Please consult our Customer Care Center.



### Panel PC Performance 19"

|   |                     |                             |  |                    |
|---|---------------------|-----------------------------|--|--------------------|
| 19" LCD TFT with LED backlight, IP65  |                     |                             |  |                    |
| SXGA 1280x1024, 16 Million colors   |                     |                             |  |                    |
| Core 2 Duo 2,26 Ghz Fan, with DDR3 RAM  |                     |                             |  |                    |
| –   |                     |                             |  | 2 (1 PCI + 1 PCIe) |
| Windows 7 64 bits Ultimate  |                     |                             |  |                    |
| Flash Disk =<32Go (SSD SLC)   | HDD =<250Go         | Flash Disk =<32Go (SSD SLC) | HDD =<250Go  |                    |
| –   |                     |                             | 1  |                    |
| 1 for storage   |                     |                             | 1 for storage + 1 for DVD-RW (or for storage with adapter) |                    |
| 2 Ethernet Gibabit, 1 front USB + 4 USB, 2 RS232, 1 DVI   |                     |                             |  |                    |
| Battery-backup*, add. RS232/485 port*   |                     |                             | + redundant RAID HDD by PCI                                |                    |
| 480x380x129   |                     |                             | 480x380x168  |                    |
| CE, UL508 industrial control, cUL, ANSI/ISA 12.12.01 for hazardous locations, Gost, C-Tick, Vijeo Designer Run Time demo. Unlimited licence to be ordered separately (VJDSNRTMPC) |                     |                             |  |                    |
| <b>HMIPPF9D0701</b>   | <b>HMIPPH9D0701</b> | –                           | <b>HMIPPH9D2701</b>  |                    |
| –   | –                   | –                           | –  |                    |
| <b>HMIPPF9D07F1</b>   | –                   | –                           | –  |                    |
| –   | <b>HMIPPH9A0701</b> | <b>HMIPPF9A2701</b>         | <b>HMIPPH9A2701</b>  |                    |
| –   | –                   | <b>HMIPPF9A27F1</b>         | –  |                    |

\*Other configurations on request. Please consult our Customer Care Center.



Vijeo Designer configuration software enables creation of automated system control operator dialogue applications for Magelis STO/STU, XBT GT, GK, GTW, GH terminals, Box PC and Panel PC. It also enables management of the multimedia functions of XBT GTW and Smart & Compact iPC (video and audio) and offers users of Ethernet terminals and iPC remote access via a Web browser (WEB Gate function).

#### Configuration

Vijeo Designer configuration software enables fast, simple processing of operator dialogue projects thanks to its ergonomics, developed around 6 configurable windows.

It also offers comprehensive application management tools:

- . Project creation; projects comprising one or several targets (terminal or iPC).
- . Recipe editor (32 groups of 256 recipes of max. 1024 ingredients).
- . User action list (eg. script) for application adaptability.
- . Application variable cross-referencing.
- . Vectorial graphic library for more attractive graphic screens.
- . Application block diagram documentation.
- . Simulation mode for simple design office application testing.
- . High-performance graphic editor for simple block diagram creation (over 30 animated preconfigured generic objects).
- . Support of layers and masks for faster development.
- . Data sharing (up to 300 variables on 8 terminals).
- . Management of 40 alphabets (including simplified Chinese, Korean, Arabic and Hebrew) with the opportunity to have 15 languages per application and dynamic change.
- . Programmable controller database sharing (Unity Pro, PL7, Concept, TwidoSoft, ProWORX, ModSoft), process variables or operators actions
- . Advanced traceability function (periodic, at event or on request).
- . Project backup on terminal for simple maintenance.
- . User-friendly data recovery tool.
- . Support of standard USB peripherals (USB key up to 4 GB).
- . Support of external USB keyboards and mice.
- . Integration with Schneider Electric equipment (buffer diag., variables access, Unity DDT and unlocated variables.)
- . Event-triggered e-mail function
- . Over 35 third party protocols
- . Multilingual software : English, French, German, Italian, Spanish, Portuguese and Simplified Chinese.
- . Printing function

The Vijeo Designer Limited Edition, free access allows you to configure the Magelis STO/STU.

#### Industrial intelligence option: Intelligent Data Service

Intelligent Data Service (IDS) is an extension of Vijeo Designer for the PC (Magelis or standard PC) which supports the implementation of control solutions for one or a number of terminals (up to 8). This extension offers total traceability. Both process variables and operator actions are tracked so that the right decisions can be made at the right time (Industrial Business Intelligence).

Powerful Data can be collected from multiple terminals via Ethernet without impairing HMI reaction times.

Flexible Various storage methods are supported, CSV file can be read directly in MS Excel, recording in user-defined format in an SQL database or secure IDV (Intelligent Data Vault) files to ensure compatibility with the requirements of 21 CFR Part 11.

#### Intelligent Data Service Report Printing option

Intelligent Data Service (IDS) Report Printing is an extension of Intelligent Data Service for the PC (Magelis or Standard PC).

This extension allows you to create new reports "from scratch" and link them to IDS data.

In addition to editing functions, IDS Report Printing allows you to preview the report before printing, print it or save it to file on disk.

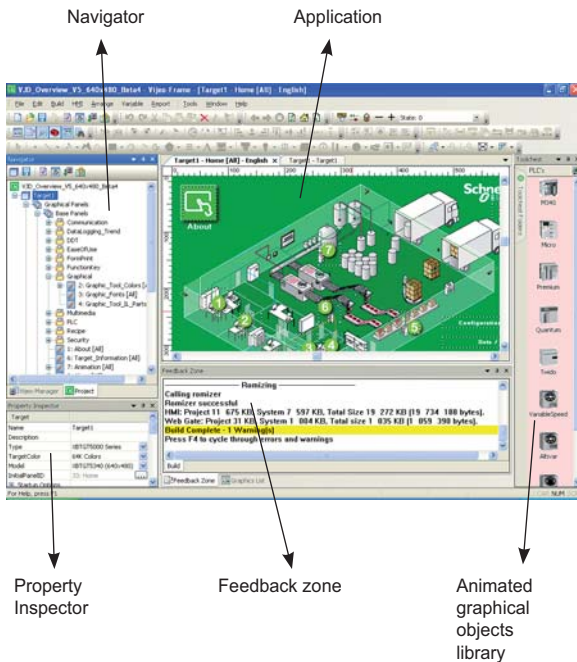

# Vijeo Designer Lite \_\_\_\_\_ Configuration software Magelis XBT N



Vijeo Designer Lite configuration software enables the creation of simple operator dialogue applications on Magelis XBT N, Small Panel ranges.

It also enables transparent recovery of all applications produced using its predecessor: XBT L1000. For simplified installation and improved consistency, Vijeo Designer Lite retains the main characteristics of Vijeo Designer software (ergonomics, interface ...) which has become the reference in the HMI field.

### Configuration

Vijeo Designer Lite software enables fast and easy creation of different types of pages (application page, alarm pages, help pages...) and the installation of navigation between pages.

It offers:

- Character fonts Byzantine, simplified Chinese, Cyrillic, Japanese
- Project reports
- Application simulation on PC
- Six languages : English, French, German, Italian, Spanish and Chinese.

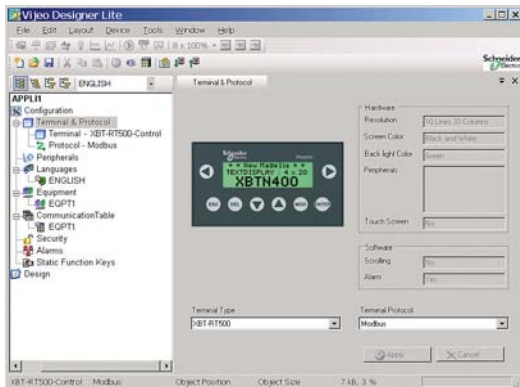

## Selection guide for Vijeo Designer Lite

| Number of licenses | Composition                     | References                     |
|--------------------|---------------------------------|--------------------------------|
| Single (1)         | Without cable<br>With USB cable | VJDSNDTMSV●●M<br>VJDSUDTMSV●●M |

Software is delivered on CD-ROM and can be executed under Windows 2000, XP and Vista.  
●● represents version number.

## Selection guide for Vijeo Designer

| Number of licences   | Composition                | References                     |
|----------------------|----------------------------|--------------------------------|
| Single (1)           | No cable<br>With USB cable | VJDSNDTGSV●●M<br>VJDSUDTGSV●●M |
| Group (3)            | No cable                   | VJDGNDTGSV●●M                  |
| Team (10)            | No cable                   | VJDTNDTGSV●●M                  |
| Facility (Unlimited) | No cable                   | VJDFNDTGSV●●M                  |

The software is supplied on DVD and runs under Windows® XP and Windows 7.  
●● represent the version number.

## Run Time on Magelis IPC

|            |            |
|------------|------------|
| Single (1) | VJDSNRTMPC |
|------------|------------|

## Run Time Intelligent Data Service

|             |               |
|-------------|---------------|
| Single (1)* | VJDSNTRCKV●●M |
|-------------|---------------|

\* Need a registered Run Time for Magelis IPC

## Run Time Intelligent Data Service Report Printing

|             |              |
|-------------|--------------|
| Single (1)* | VJDSNTRPR●●M |
|-------------|--------------|

\* Need a registered Run Time for Intelligent Data Service

## What is an explosive atmosphere according to the Directive?

It is the mixing with air, in atmospheric conditions, of flammable substances in the form of gas, vapour, mist or dust which, in the event of combustion, spreads throughout the non burning mix.

1

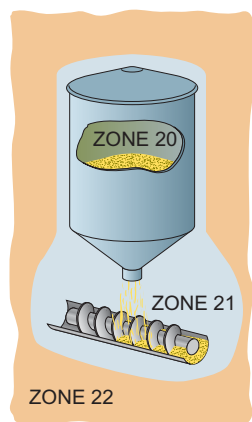

### Implementation of European Directives

#### > Directive 99/92/EC

This requires that a risk analysis be performed for all industrial processes.

If there is any risk of an explosion:

- the zones are defined and physically identified,
- the installation is classified by governing bodies.

#### > Directive 94/9/EC

This requires certification of the products in accordance with the classification of the zones of use

#### > Dust zones

- Zone 20: area where an explosive atmosphere exists in the form of combustible clouds of dust in the air, either permanently, for long periods or frequently.
- Zone 21: area where an explosive atmosphere exists in the form of combustible clouds of dust in the air during normal operation occasionally.
- Zone 22: area where an explosive atmosphere in the form of combustible clouds of dust in the air is unlikely to occur during normal operation but, if it does occur, it is only for a short period.



## Small Panel Magelis XBT N with matrix screen (1)



| Type  |                             | Characteristics   |         |  |                    |                             |
|---|-----------------------------|---|---------|--|--------------------|-----------------------------|
| <b>Conformity</b>                                       |                             | Directive ATEX 94/9/CE, EN 60079-15, EN 50281-1-1 + A1, IEC 61241-0, EN 61241-1 |         |  |                    |                             |
| <b>Zone D (dust)</b>                                    |                             | 22  |         |  |                    |                             |
| <b>EC type examination certificate number / marking</b> |                             | INERIS 05ATEX3016X /  II 3 G D EEx nA nC IIC T5 - Ex tD A22 IP65 T100°C         |         |  |                    |                             |
| Display   | Capacity                    | 2 lines, 20 characters  |         | 1 to 4 lines, 5 to 20 characters   |                    |                             |
|   | Type                        | Back-lit LCD green  |         | Back-lit LCD 3 colours green, orange, red  | Back-lit LCD green |                             |
| <b>Data entry</b>                                       |                             | Via keypad with 8 keys (4 customizable keys)                                    |         |  |                    |                             |
| <b>Function</b>   | Representation of variables | Alphanumeric  |         |  |                    |                             |
|   | Alarm log                   | No  | Yes     | Yes  | Yes                | Yes                         |
| <b>Communication</b>                                    | Serial link                 | 1 RJ45 (RS 232 - RS 485)  |         | 1 Sub-D25 (RS 232 - RS 485)  |                    |                             |
| <b>Downloadable protocols</b>                           |                             | Uni-TE, Modbus Master   |         | Uni-TE, Modbus Master, Siemens, Rockwell, Omron, Mitsubishi                                |                    | Modbus                      |
| <b>Development software</b>                             |                             | Vijeo Designer Lite (on Windows 2000 and XP)                                    |         |  |                    |                             |
| <b>Dimensions W x D x H</b>                             |                             | 132 x 37 x 74 mm  |         |  |                    |                             |
| <b>Compatibility with PLCs</b>                          |                             | Twido, Modicon TSX Micro, Modicon Premium, Modicon M340                         |         | Twido, Modicon TSX Micro, Modicon Premium, Modicon Quantum, Modicon Momentum, Modicon M340 |                    | Motor starter Tesys Model U |
| <b>Supply voltages</b>                                  |                             | 5 VDC or PLC power supply   |         | 24 VDC   |                    |                             |
| <b>References</b>                                       |                             | XBTN200   | XBTN400 | XBTN410  | XBTN401            | XBTNU400                    |

(1) Except XBTN200: alphanumeric screen.



| Type  |                             | Characteristics  |                  |   |   |                  |
|---|-----------------------------|--|------------------|---|---|------------------|
| <b>Conformity</b>                                       |                             | Directive ATEX 94/9/CE, EN 60079-15, EN 61241-0, EN 61241-1, EN 60079-0 (1)  |                  |   |   |                  |
| <b>Zone D (dust)</b>                                    |                             | 22   |                  |   |   |                  |
| <b>EC type examination certificate number / marking</b> |                             | INERIS 06ATEX3024X / INERIS 08ATEX3024X / INERIS 06ATEX3024X / INERIS 08ATEX3024X / INERIS 08ATEX3024X /  II 3 G D EEx nA nC IIC T4 - Ex tD A22 IP64 T135°C |                  |   |   |                  |
| <b>Display</b>  | LCD screen size             | 3.8"   |                  |   |   |                  |
|   | Type                        | STN monochrome, amber or red   |                  |   | TFT colour                                  |                  |
| <b>Functions</b>  | Representation of variables | Alphanumeric, bitmap, bargraph, gauge, button, light, clock, flashing light, keypad  |                  |   |   |                  |
|   | Curves / Alarm logs         | Yes, with log / Yes, incorporated  |                  |   |   |                  |
| <b>Communication</b>                                    | Serial link                 | 1 RJ45 (RS 232 - RS 485)   |                  |   |   |                  |
|   | Networks                    | -  |                  | Ethernet, IEEE 802.3<br>10 BASE-T, RJ45 | Ethernet, IEEE 802.3<br>10/100 BASE-T, RJ45 |                  |
| <b>Downloadable protocols</b>                           |                             | Mitsubishi (Melsec), Omron (Sysmac), Rockwell Automation (Allen Bradley), Siemens (Simatic)<br>Uni-TE, Modbus, Modbus TCP  |                  |   |   |                  |
| <b>Development software</b>                             |                             | Vijeo Designer VJD●●●TG●V●●M (on Windows Vista, XP and 2000)   |                  |   |   |                  |
| <b>Dimensions W x D x H</b>                             |                             | 130x41x104mm   |                  |   |   |                  |
| <b>Compatibility with PLCs</b>                          |                             | Twido, Modicon TSX Micro, Modicon Premium, Modicon Quantum, Modicon M340   |                  |   |   |                  |
| <b>«Compact Flash» card slot</b>                        |                             | No   |                  |   |   |                  |
| <b>USB port</b>   |                             | -  | 1                | -                                       | 1   | 1                |
| <b>Built-in Ethernet TCP/IP</b>                         |                             | No   |                  | Yes                                     |   |                  |
| <b>Supply voltage</b>                                   |                             | 24 VDC   |                  |   |   |                  |
| <b>References</b>                                       |                             | <b>XBTGT1100</b>   | <b>XBTGT1105</b> | <b>XBTGT1130</b>                        | <b>XBTGT1135</b>                            | <b>XBTGT1335</b> |

(1) Does not take effect for XBTGT1100 and XBTGT1130



## Magelis XBT GT with 5.7" touchscreen



| Type  |                             | Characteristics  |                  |   |   |                  |
|---|-----------------------------|--|------------------|---|---|------------------|
| <b>Conformity</b>                                       |                             | Directive ATEX 94/9/CE, EN 60079-15, EN 61241-0, EN 61241-1  |                  |   |   |                  |
| <b>Zone D (dust)</b>                                    |                             | 22   |                  |   |   |                  |
| <b>EC type examination certificate number / marking</b> |                             | INERIS 06ATEX3024X /  II 3 G D EEx nA nC IIB T3 - Ex tD A22 IP64 T200°C |                  |   |   |                  |
| <b>Display</b>  | LCD screen size             | 5.7"   |                  |   |   |                  |
|   | Type                        | Back-lit STN, monochrome<br>blue      black and white  |                  | STN, colour<br>4096 colours                 | TFT, colour<br>65536 colours                |                  |
| <b>Functions</b>  | Representation of variables | Alphanumeric, bitmap, bargraph, gauge, button, light, clock, flashing light, keypad  |                  |   |   |                  |
|   | Curves / Alarm logs         | Yes, with log / Yes, incorporated  |                  |   |   |                  |
| <b>Communication</b>                                    | Serial link                 | 1 Sub-D9 (RS 232/RS 422 - RS 485) + 1 RJ45 (RS 485)  |                  |   |   |                  |
|   | Networks                    | -  |                  | Ethernet, IEEE 802.3<br>10/100 BASE-T, RJ45 | Ethernet, IEEE 802.3<br>10/100 BASE-T, RJ45 |                  |
| <b>Downloadable protocols</b>                           |                             | Mitsubishi (Melsec), Omron (Sysmac), Rockwell Automation (Allen Bradley), Siemens (Simatic)<br>Uni-TE, Modbus, Modbus TCP/IP                               |                  |   |   |                  |
| <b>Development software</b>                             |                             | Vijeo Designer VJD●●●TG●V●●M (on Windows Vista, XP and 2000)   |                  |   |   |                  |
| <b>Dimensions W x D x H</b>                             |                             | 167.5x60x135mm   |                  |   |   |                  |
| <b>Compatibility with PLCs</b>                          |                             | Twido, Modicon TSX Micro, Modicon Premium, Modicon Quantum, Modicon M340, Modicon Momentum   |                  |   |   |                  |
| <b>«Compact Flash» card slot</b>                        |                             | No   | Yes              |   |   |                  |
| <b>USB port</b>   |                             | 1  |                  |   |   |                  |
| <b>Video in</b>   |                             | No   |                  |   |   |                  |
| <b>Built-in Ethernet TCP/IP</b>                         |                             | No   | No               | Yes   | No  | Yes              |
| <b>Supply voltage</b>                                   |                             | 24 VDC   |                  |   |   |                  |
| <b>References</b>                                       |                             | <b>XBTGT2110</b>   | <b>XBTGT2120</b> | <b>XBTGT2130</b>                            | <b>XBTGT2220</b>                            | <b>XBTGT2330</b> |

1



| Type  |                             | Characteristics  |           |           |            |           |   |           |            |           |            |
|---|-----------------------------|--|-----------|-----------|------------|-----------|---|-----------|------------|-----------|------------|
| <b>Conformity</b>                                       |                             | Directive ATEX 94/9/CE, EN 60079-15, EN 61241-0, EN 61241-1  |           |           |            |           |   |           |            |           |            |
| <b>Zone D (dust)</b>                                    |                             | 22   |           |           |            |           |   |           |            |           |            |
| <b>EC type examination certificate number / marking</b> |                             | INERIS 06ATEX3024X /  II 3 G D              |           |           |            |           | INERIS 06ATEX3024X /  II 3 D |           |            |           |            |
|   |                             | EEx nA nC IIB T4 - Ex tD A22 IP64 T135°C   |           |           |            |           |   |           |            |           |            |
| <b>Display</b>  | LCD screen size             | 7.5"   |           |           |            | 10.4"     |   |           | 12.1"      |           | 15"        |
|   | Type (colour)               | STN  | TFT       | TFT       | STN        | TFT       | TFT   | TFT       | TFT        | TFT       |            |
|   | Number of colours           | 4096   | 65536     | 65536     | 4096       | 65536     | 65536   | 65536     | 65536      | 65536     |            |
| <b>Functions</b>  | Representation of variables | Alphanumeric, bitmap, bargraph, gauge, button, light, clock, flashing light, keypad  |           |           |            |           |   |           |            |           |            |
|   | Curves / Alarm logs         | Yes, with log / Yes, incorporated  |           |           |            |           |   |           |            |           |            |
| <b>Communication</b>                                    | Serial link                 | 1 Sub-D9 (RS 232/RS 422 - RS 485) + 1 RJ45 (RS 485)  |           |           |            |           |   |           |            |           |            |
|   | Networks                    | Ethernet, IEEE 802.3 10/100 BASE-T, RJ 45  |           |           |            |           |   |           |            |           |            |
| <b>Downloadable protocols</b>                           |                             | Mitsubishi (Melsec), Omron (Sysmac), Rockwell Automation (Allen Bradley), Siemens (Simatic)<br>Uni-TE, Modbus, Modbus TCP/IP |           |           |            |           |   |           |            |           |            |
| <b>Development software</b>                             |                             | Vijeo Designer VJD●●●TG●V●●M (on Windows Vista, XP and 2000)   |           |           |            |           |   |           |            |           |            |
| <b>Dimensions W x D x H (mm)</b>                        |                             | 215x60x170   |           |           | 313x56x239 |           | 271x57x213  |           | 313x56x239 |           | 395x60x294 |
| <b>Compatibility with PLCs</b>                          |                             | Twido, Modicon TSX Micro, Modicon Premium, Modicon Quantum, Modicon M340   |           |           |            |           |   |           |            |           |            |
| <b>«Compact Flash» card slot</b>                        |                             | Yes  |           |           |            |           |   |           |            |           |            |
| <b>USB port</b>   |                             | 1  | 1         | 1         | 2          | 2         | 2   | 2         | 2          | 2         |            |
| <b>Video in</b>   |                             | No   | No        | Yes       | No         | No        | Yes   | No        | Yes        | Yes       |            |
| <b>Built-in Ethernet TCP/IP</b>                         |                             | Yes  |           |           |            |           |   |           |            |           |            |
| <b>Supply voltage</b>                                   |                             | 24 VDC   |           |           |            |           |   |           |            |           |            |
| <b>References</b>                                       |                             | XBTGT4230  | XBTGT4330 | XBTGT4340 | XBTGT5230  | XBTGT5330 | XBTGT5340   | XBTGT6330 | XBTGT6340  | XBTGT7340 |            |



# Notes



# Zelio

Designed for hard-wired logic control applications to complement PLCs when performing simple functions such as counting, measurement and control, the single-function products in the Zelio range of relays offer optimum results.

Designed for the management of simple automation systems, Zelio Logic smart relays provide a real alternative to solutions based on cabled logic or specific cards.



# 2

The challenges of industrial competitiveness mean that control systems are now present in all fields of application. To meet your requirements, Schneider Electric has a very comprehensive offer of automation products, for all sectors of activity. Benefit from high performance, efficient and environmentally friendly products that are designed to reduce your energy costs and increase the safety of personnel and equipment.



# Modicon

From the simplest machine to the smartest industrial process, Modicon automation platforms improve performance, quality and profitability for your installations. Conforming to international standards and simple to set up, the Modicon range integrates seamlessly into any control system.

# 2 | Automation



## Relays

|  |              |
|--|--------------|
| Electromechanical plug-in relays, <b>Zelio Relay</b> ..... | 2/2 to 2/4   |
| Solid-state relays, <b>Zelio Relay</b> .....               | 2/5          |
| Control and measurement relays, <b>Zelio Control</b> ..... | 2/6 to 2/10  |
| Counters, <b>Zelio Count</b> .....                         | 2/11         |
| Timing relays, <b>Zelio Time</b> .....                     | 2/12 to 2/13 |
| Analog interface, <b>Zelio Analog</b> .....                | 2/14 to 2/15 |

## Controllers (PLC) for commercial machines

|  |              |
|--|--------------|
| Smart relays, <b>Zelio Logic</b> : 10 to 40 I/O .....                            | 2/16 to 2/17 |
| Programmable controllers, <b>Twido</b> : 10 to 100 I/O 1µs per Instruction ..... | 2/18 to 2/19 |

## Controllers (PLC & PAC) for industrial machines

|   |              |
|---|--------------|
| Logic controllers, <b>Modicon M238</b> : 20 to 248 I/O, 0.3 µs per Instruction .....                  | 2/20 to 2/21 |
| Logic controllers, <b>Modicon M258</b> : 42 to 2400 I/O, 0.022 µs per Instruction .....               | 2/22 to 2/23 |
| Motion controllers, <b>Modicon LMC058</b> : 42 to 2400 I/O, 4 synchronized Axis in 2ms .....          | 2/24         |
| HMI controllers, <b>Magelis XBTGC</b> : 18 to 96 I/O .....  | 2/25         |
| Drive controller, <b>Altivar IMC</b> : 1000 instructions in 942 µs Web Server, CANopen, PLCopen ..... | 2/26         |

## Programmable Automation Controllers (PACs)

|   |              |
|---|--------------|
| Mid range PLC <b>Modicon M340</b> : for industrial process and infrastructure .....                           | 2/28 to 2/37 |
| Large PLC <b>Modicon Premium</b> : for discrete or process applications and high availability solutions ..... | 2/38 to 2/45 |
| Large PLC <b>Modicon Quantum</b> : for process applications & high availability solutions .....               | 2/46 to 2/53 |

## Software

|  |              |
|--|--------------|
| Programming software, <b>Zelio Soft 2</b> .....            | 2/17         |
| Programming software, <b>Twido Suite</b> .....             | 2/19         |
| Machine programming software, <b>SoMachine</b> .....       | 2/27         |
| Configuration software, <b>Unity Pro</b> .....             | 2/54 to 2/55 |
| Programming software, <b>PL7, Concept, ProWORX32</b> ..... | 2/56 to 2/57 |
| SCADA software, <b>Vijeo Citect</b> .....                  | 2/58         |
| Reporting software, <b>Vijeo Historian</b> .....           | 2/59         |



| Type of relay   | Interface relays<br>RSB          |            |            | Miniature relays<br>RXM     |           |           |           |           |
|---|----------------------------------|------------|------------|-----------------------------|-----------|-----------|-----------|-----------|
| <b>Contact characteristics</b>                            |                                  |            |            |                             |           |           |           |           |
| Thermal current I <sub>th</sub> in A (temperature ≤ 55°C) | 8                                | 12         | 16         | 12                          | 10        | 6         | 3         |           |
| Number of contacts  | 2 "C/O"                          | 1 "C/O"    | 1 "C/O"    | 2 "C/O"                     | 3 "C/O"   | 4 "C/O"   | 4 "C/O"   |           |
| Contact material  | AgNi                             | AgNi       | AgNi       | AgNi                        | AgNi      | AgNi      | AgAu      |           |
| Switching voltage, min. / max.                            | 5 / 250 VAC/DC                   |            |            | 12 / 250 VAC/DC             |           |           |           |           |
| Switching capacity, min. / max. (mA / VA)                 | 5 / 2000                         | 5 / 3000   | 5 / 4000   | 10 / 3000                   | 10 / 2500 | 10 / 1500 | 2 / 1500  |           |
| <b>Coil characteristics</b>                               |                                  |            |            |                             |           |           |           |           |
| Average consumption, inrush,                              | 0.75 VA / 0.45 W                 |            |            | 1.2 VA / 0.9 W              |           |           |           |           |
| Permissible voltage variation                             | 0.8/0.85...1.1 Un (50/60Hz or =) |            |            | 0.8...1.1 Un (50/60Hz or =) |           |           |           |           |
| References  | (1)                              | (1)        | (1)        | (2)                         | (2)       | (2)       |           |           |
| Coil supply voltage<br>on DC                              | 6 VDC                            | RSB2A080RD | RSB1A120RD | RSB1A160RD                  | –         | –         | –         |           |
|   | 12 VDC                           | RSB2A080JD | RSB1A120JD | RSB1A160JD                  | RXM2AB2JD | RXM3AB2JD | RXM4AB2JD | RXM4GB2JD |
|   | 24 VDC                           | RSB2A080BD | RSB1A120BD | RSB1A160BD                  | RXM2AB2BD | RXM3AB2BD | RXM4AB2BD | RXM4GB2BD |
|   | 48 VDC                           | RSB2A080ED | RSB1A120ED | RSB1A160ED                  | RXM2AB2ED | RXM3AB2ED | RXM4AB2ED | RXM4GB2ED |
|   | 60 VDC                           | RSB2A080ND | RSB1A120ND | RSB1A160ND                  | –         | –         | –         | –         |
| 110 VDC   | RSB2A080FD                       | RSB1A120FD | RSB1A160FD | RXM2AB2FD                   | RXM3AB2ED | RXM4AB2ED | RXM4GB2ED |           |
| Coil supply voltage<br>on AC                              | 24 VAC                           | RSB2A080B7 | RSB1A120B7 | RSB1A160B7                  | RXM2AB2B7 | RXM3AB2B7 | RXM4AB2B7 | RXM4GB2B7 |
|   | 48 VAC                           | RSB2A080E7 | RSB1A120E7 | RSB1A160E7                  | RXM2AB2E7 | RXM3AB2E7 | RXM4AB2E7 | RXM4GB2E7 |
|   | 120 VAC                          | RSB2A080F7 | RSB1A120F7 | RSB1A160F7                  | RXM2AB2F7 | RXM3AB2F7 | RXM4AB2F7 | RXM4GB2F7 |
|   | 220 VAC                          | RSB2A080M7 | RSB1A120M7 | RSB1A160M7                  | –         | –         | –         | –         |
|   | 230 VAC                          | RSB2A080P7 | RSB1A120P7 | RSB1A160P7                  | RXM2AB2P7 | RXM3AB2P7 | RXM4AB2P7 | RXM4GB2P7 |
|   | 240 VAC                          | RSB2A080U7 | RSB1A120U7 | RSB1A160U7                  | –         | –         | –         | RXM4GB2U7 |

## Sockets for relays

| Type of socket  | For interface relays RSB |              |              | For miniature relays RXM   |            |            |            |  |
|---|--------------------------|--------------|--------------|----------------------------|------------|------------|------------|--|
| <b>Mixed input/output type sockets with location for protection module</b>    |                          |              |              |                            |            |            |            |  |
|   | –                        | –            | –            | RXZE2M114(5)               | –          | RXZE2M114  | RXZE2M114  |  |
|   | –                        | –            | –            | RXZE2M114M(5)              | –          | RXZE2M114M | RXZE2M114M |  |
| <b>Separate input/output type sockets with location for protection module</b> |                          |              |              |                            |            |            |            |  |
|   | RSZE1S48M                | RSZE1S35M    | RSZE1S48M(3) | RXZE2S108M                 | RXZE2S111M | RXZE2S114M | RXZE2S114M |  |
| <b>Protection modules</b>   |                          |              |              |                            |            |            |            |  |
| Diode   | 6...230 VDC              | RZM040W      |              | RXM040W                    |            |            |            |  |
| RC circuit  | 24...60 VAC              | RZM041BN7    |              | RXM041BN7                  |            |            |            |  |
|   | 110...240 VAC            | RZM041FU7    |              | RXM041FU7                  |            |            |            |  |
| Varistor  | 6...24 VDC or AC         | RZM021RB (6) |              | RXM021RB                   |            |            |            |  |
|   | 24...60 VDC or AC        | RZM021BN (6) |              | RXM021BN                   |            |            |            |  |
|   | 110...230 VDC or AC      | RZM021FP (6) |              | RXM021FP                   |            |            |            |  |
|   | 24 VDC or AC             | –            |              | –                          |            |            |            |  |
|   | 240 VDC or AC            | –            |              | –                          |            |            |            |  |
| Multifunction timer module  | 24...230 VDC or AC       | –            |              | –                          |            |            |            |  |
| <b>Accessories</b>  |                          |              |              |                            |            |            |            |  |
| Plastic maintaining clamp   | RSZR215                  |              |              | RXZR335                    |            |            |            |  |
| Metal maintaining clamp   | –                        |              |              | RXZ400                     |            |            |            |  |
| Label for socket  | RSZL300                  |              |              | RXZL420 (except RXZE2M114) |            |            |            |  |
| Bus jumper  | 2 poles                  | –            |              |                            | RXZS2      |            |            |  |
| DIN rail adapter  | –                        |              |              | RXZE2DA                    |            |            |            |  |
| Panel mounting adapter  | –                        |              |              | RXZE2FA                    |            |            |            |  |

(1) References for relays without socket, for relays with socket, add the letter **S** to the end of the selected reference. (Example: RSB2A080B7 becomes RSB2A080B7S).

(2) References for relays with LED, for relays without LED, replace the number 1 in the reference by **2**. (Example: RXM2AB2JD becomes RXM2AB1JD)

(3) To use RSB 1A160 ●● relay with socket, terminals must be interconnected

## Universal and power relays



| Universal relays RUM |            |            |            |            | Power relays RPM |                |                |              | RPF                |                    |
|----------------------|------------|------------|------------|------------|------------------|----------------|----------------|--------------|--------------------|--------------------|
| Cylindrics           |            | Faston     |            |            |                  |                |                |              |                    |                    |
| 10                   | 10         | 3          | 10         | 10         | 15               | 15             | 15             | 15           | 30 (4)             | 30 (4)             |
| 2 "C/O"              | 3 "C/O"    | 3 "C/O"    | 2 "C/O"    | 3 "C/O"    | 1 "C/O"          | 2 "C/O"        | 3 "C/O"        | 4 "C/O"      | 2 "N/O"            | 2 "C/O"            |
| AgNi                 | AgNi       | AgAu       | AgNi       | AgNi       | AgNi             | AgNi           | AgNi           | AgNi         | AgSnO <sub>2</sub> | AgSnO <sub>2</sub> |
| 12 / 250 VAC/DC      |            |            |            |            | 12 / 250 VAC/DC  |                |                |              | 12 / 250 VAC/DC    |                    |
| 10 / 2500            | 10 / 2500  | 3 / 750    | 10 / 2500  | 10 / 2500  | 100 / 3750       | 100 / 3750     | 100 / 3750     | 100 / 3750   | 100 / 7200         | 100 / 7200         |
| 2...3 VA / 1.4 W     |            |            |            |            | 0.9 VA / 0.7 W   | 1.2 VA / 0.9 W | 1.5 VA / 1.7 W | 1.5 VA / 2 W | 4 VA / 1.7 W       |                    |
| (2)                  | (2)        | –          | (2)        | (2)        | (2)              | (2)            | (2)            | (2)          | –                  | –                  |
| –                    | –          | –          | –          | –          | –                | –              | –              | –            | –                  | –                  |
| RUMC2AB2JD           | RUMC3AB2JD | –          | RUMF2AB2JD | RUMF3AB2JD | RPM12JD          | RPM22JD        | RPM32JD        | RPM42JD      | RPF2AJD            | RPF2BJD            |
| RUMC2AB2BD           | RUMC3AB2BD | RUMC3GB2BD | RUMF2AB2BD | RUMF3AB2BD | RPM12BD          | RPM22BD        | RPM32BD        | RPM42BD      | RPF2ABD            | RPF2BBD            |
| RUMC2AB2ED           | RUMC3AB2ED | RUMC3GB2ED | RUMF2AB2ED | RUMF3AB2ED | RPM12ED          | RPM22ED        | RPM32ED        | RPM42ED      | –                  | –                  |
| –                    | –          | –          | –          | –          | –                | –              | –              | –            | –                  | –                  |
| RUMC2AB2FD           | RUMC3AB2FD | –          | RUMF2AB2FD | RUMF3AB2FD | RPM12FD          | RPM22FD        | RPM32FD        | RPM42FD      | RPF2AFD            | RPF2BFD            |
| RUMC2AB2B7           | RUMC3AB2B7 | RUMC3GB2B7 | RUMF2AB2B7 | RUMF3AB2B7 | RPM12B7          | RPM22B7        | RPM32B7        | RPM42B7      | RPF2AB7            | RPF2BB7            |
| RUMC2AB2E7           | RUMC3AB2E7 | RUMC3GB2E7 | RUMF2AB2E7 | RUMF3AB2E7 | RPM12E7          | RPM22E7        | RPM32E7        | RPM42E7      | –                  | –                  |
| RUMC2AB2F7           | RUMC3AB2F7 | RUMC3GB2F7 | RUMF2AB2F7 | RUMF3AB2F7 | RPM12F7          | RPM22F7        | RPM32F7        | RPM42F7      | RPF2AF7            | RPF2BF7            |
| –                    | –          | –          | –          | –          | –                | –              | –              | –            | –                  | –                  |
| RUMC2AB2P7           | RUMC3AB2P7 | RUMC3GB2P7 | RUMF2AB2P7 | RUMF3AB2P7 | RPM12P7          | RPM22P7        | RPM32P7        | RPM42P7      | RPF2AP7            | RPF2BP7            |
| –                    | –          | –          | –          | –          | –                | –              | –              | –            | –                  | –                  |

| For universal relays RUM |         |         |         |         | For power relays RPM      |         |                           |        | For power relays RPF |   |
|--------------------------|---------|---------|---------|---------|---------------------------|---------|---------------------------|--------|----------------------|---|
| RUZC2M                   | RUZC3M  | RUZC3M  | –       | –       | RPZF1                     | RPZF2   | RPZF3                     | RPZF4  | –                    | – |
| –                        | –       | –       | –       | –       | –                         | –       | –                         | –      | –                    | – |
| RUZSC2M                  | RUZSC3M | RUZSC3M | RUZSF3M | RUZSF3M | –                         | –       | –                         | –      | –                    | – |
| RUW240BD                 | –       | –       | –       | –       | 1 and 2 poles<br>RXM040W  | –       | 3 and 4 poles<br>RUW240BD | –      | –                    |   |
| –                        | –       | –       | –       | –       | RXM041BN7                 | –       | –                         | –      | –                    |   |
| RUW241P7                 | –       | –       | –       | –       | RXM041FU7                 | –       | RUW241P7                  | –      | –                    |   |
| –                        | –       | –       | –       | –       | RXM021RB                  | –       | –                         | –      | –                    |   |
| –                        | –       | –       | –       | –       | RXM021BN                  | –       | –                         | –      | –                    |   |
| –                        | –       | –       | –       | –       | RXM021FP                  | –       | –                         | –      | –                    |   |
| RUW242B7                 | –       | –       | –       | –       | RUW242B7                  | –       | –                         | –      | –                    |   |
| RUW242P7                 | –       | –       | –       | –       | –                         | –       | RUW242P7                  | –      | –                    |   |
| RUW101MW                 | –       | –       | –       | –       | –                         | –       | RUW101MW                  | –      | –                    |   |
|                          |         |         |         |         |                           |         |                           |        |                      |   |
| –                        | –       | –       | –       | –       | –                         | –       | –                         | –      | –                    | – |
| RUZC200                  | –       | –       | –       | –       | RPZF1 (for 1 pole relays) | –       | –                         | –      | –                    |   |
| RUZL420                  | –       | –       | –       | –       | –                         | –       | –                         | –      | –                    |   |
| RUZS2                    | –       | –       | –       | –       | –                         | –       | –                         | –      | –                    |   |
| –                        | –       | –       | –       | –       | RPZ1DA                    | RXZE2DA | RPZ3DA                    | RPZ4DA | –                    | – |
| –                        | –       | –       | –       | –       | RPZ1FA                    | RXZE2FA | RPZ3FA                    | RPZ4FA | –                    | – |

(4) 30A with 13 mm space between relays; 25 A when relay mounting side by side

(5) Max 10 A operating

(6) With LED



|                                      |                       |   |                 |
|--------------------------------------|-----------------------|---|-----------------|
| <b>Type of relay</b>                 |                       | <b>Pre-assembled equipped with LED and protection circuit</b> |                 |
|                                      |                       | <b>Sold in lots of 10</b>                                     |                 |
| <b>Contact characteristics</b>       |                       |   |                 |
| Thermal current I <sub>th</sub> in A | 6                     |   |                 |
| Number of contacts                   | 1 C/O                 |   |                 |
| Contact material                     | AgSnO <sub>2</sub>    |   |                 |
| Switching voltage, min/max           | 12 / 300 V AC/DC      |   |                 |
| Switching capacity min/max (mA /VA)  | 100 / 1500            |   |                 |
| <b>Coil characteristics</b>          |                       |   |                 |
| Average consumption, inrush          | 0.17 W                |   |                 |
| permissible voltage variation        | -10% / +15%           |   |                 |
| Socket connexion                     | Screw connector       |   | Spring terminal |
|                                      | Socket supply voltage | Coil supply voltage   |                 |
| References                           | 12 V AC/DC            | 12 V DC   | RSL1PVJU        |
|                                      | 24 V AC/DC            | 24 V DC   | RSL1PVBU        |
|                                      | 48 V AC/DC            | 48 V DC   | RSL1PVEU        |
|                                      | 110 V AC/DC           | 60 V DC   | RSL1PVFU        |
|                                      | 230 V AC/DC           | 60 V DC   | RSL1PVPU        |
|                                      |                       |   | RSL1PRJU        |
|                                      |                       |   | RSL1PRBU        |
|                                      |                       |   | RSL1PREU        |
|                                      |                       |   | RSL1PRFU        |
|                                      |                       |   | RSL1PRPU        |

### RSL relays



|                      |                     |                                    |  |
|----------------------|---------------------|------------------------------------|--|
| <b>Type of relay</b> |                     | <b>Relay for customer assembly</b> |  |
|                      |                     | <b>Sold in lots of 10</b>          |  |
| Number of contacts   | 1 C/O               |                                    |  |
|                      | Coil supply voltage |                                    |  |
| References           | 12 V DC             | RSL1AB4JD                          |  |
|                      | 24 V DC             | RSL1AB4BD                          |  |
|                      | 48 V DC             | RSL1AB4ED                          |  |
|                      | 60 V DC             | RSL1AB4ND                          |  |

### Sockets



|                       |                       |  |                 |
|-----------------------|-----------------------|--|-----------------|
| <b>Type of socket</b> |                       | <b>Sockets for customer assembly with LED and protection circuit</b> |                 |
|                       |                       | <b>Sold in lots of 10</b>  |                 |
| Socket connection     | Screw connector       |  | Spring terminal |
|                       | Socket supply voltage |  |                 |
| References            | 12 and 24 V AC/DC     | RSLZVA1  | RSLZRA1         |
|                       | 48 and 60 V AC/DC     | RSLZVA2  | RSLZRA2         |
|                       | 110 V AC/DC           | RSLZVA3  | RSLZRA3         |
|                       | 230 V AC/DC           | RSLZVA4  | RSLZRA4         |

# Solid-state relays

## SSRP relays



| Type of relay                        | Panel mounted<br>without heat sink and thermal interface |             |             |               |               |              |
|--------------------------------------|--|-------------|-------------|---------------|---------------|--------------|
| <b>Contact characteristics</b>       |  |             |             |               |               |              |
| Thermal current I <sub>th</sub> in A | 10   | 25          | 50          | 75            | 90            | 125          |
| Number of contacts                   | 1 NO   |             |             |               |               |              |
| Type if switching                    | Zero voltage switching                                   |             |             |               |               |              |
| Output                               | SPST contact   |             |             |               |               |              |
| Connection                           | Screw connector  |             |             |               |               |              |
| Control voltage range                | 3...32 V DC  |             |             | 4...32 V DC   |               |              |
| Operating voltage                    | 24...280 V AC  |             |             | 48...530 V AC | 48...660 V AC |              |
| References                           | SSRPCDS10A1  | SSRPCDS25A1 | SSRPCDS50A1 | SSRPCDS75A2   | SSRPCDS90A3   | SSRPCDS125A3 |
| <b>Control voltage range</b>         |  |             |             |               |               |              |
| Control voltage range                | 90...280 V AC  |             |             |               |               |              |
| Operating voltage                    | 24...280 V AC  |             |             | 80...530 V AC | 48...660 V AC |              |
| References                           | SSRPP8S10A1  | SSRPP8S25A1 | SSRPP8S50A1 | SSRPP8S75A2   | SSRPP8S90A3   | SSRPP8S125A3 |

2

## SSRD relays



| Type of relay                        | Rail DIN mounted<br>With integrated heat sink |             |             |               |
|--------------------------------------|---|-------------|-------------|---------------|
| <b>Contact characteristics</b>       |   |             |             |               |
| Thermal current I <sub>th</sub> in A | 10  | 20          | 30          | 45            |
| Number of contacts                   | 1 NO  |             |             |               |
| Type if switching                    | Zero voltage switching                        |             |             |               |
| Output                               | SPST contact                                  |             |             |               |
| Connection                           | Screw connector                               |             |             |               |
| Control voltage range                | 4...32 V DC                                   |             |             | 3...32 V DC   |
| Operating voltage                    | 24...280 V AC                                 |             |             |               |
| References                           | SSRD0S10A1                                    | SSRD0S20A1  | SSRD0S30A1  | SSRD0S45A1    |
| <b>Control voltage range</b>         |   |             |             |               |
| Control voltage range                | 90...280 V AC                                 |             |             | 90...140 V AC |
| Operating voltage                    | 24...280 V AC                                 |             |             |               |
| References                           | SSRDP8S10A1                                   | SSRDP8S20A1 | SSRDP8S30A1 | SSRDP8S45A1   |

## Accessories



| Type of accessory | Heat sink | Thermal interface |
|-------------------|-----------|-------------------|
| For relay         | SSRP      |                   |
| References        | SSRAH1    | SSRAT1            |

# Zelio Control Relays

## 3-phase monitoring relays



| Function   | presence of phase<br>+phase sequence |               | +phase sequence, +regeneration<br>+phase unbalance, +under/over voltage |               |
|------------|--------------------------------------|---------------|---|---------------|
|            | Monitoring voltage range             | 208...480 VAC | 208...440 VAC   | 208...480 VAC |
| Outputs    | 1 C/O                                | 2 C/O         | 1 C/O   | 2 C/O         |
| References | RM17TG00                             | RM17TG20      | RM17TE00  | RM35TF30      |



| Function   | presence of phase<br>+under/over voltage |               | +presence of neutral<br>+under/over voltage |
|------------|--|---------------|---|
|            | Monitoring voltage range                 | 208...480 VAC | 220...480 VAC                               |
| Outputs    | 1 C/O                                    | 2 C/O         | 2 C/O                                       |
| References | RM17UB310                                | RM35UB330     | RM35UB3N30                                  |

## Level / Speed monitoring relays



| Function         | Conductive liquid<br>level monitoring                            | Non-conductive material<br>level monitoring | Over/under<br>Speed monitoring  |
|------------------|--|---|---|
| Power supply     | 24...240 VAC/DC  |   |   |
| Monitoring range | 0,25...5 K $\Omega$<br>5...100 K $\Omega$<br>0,05...1 M $\Omega$ | Input of sensor :<br>Contact / PNP / NPN    | Interval between pulses:<br>0.05...0.5 s, 0.1...1 s, 0.5...5 s<br>1...10 s, 0.1...1 mn, 0.5...5 mn<br>1...10 mn |
| Output           | 2 C/O  | 1 C/O                                       | 1 C/O   |
| Reference        | RM35LM33MW   | RM35LV14MW                                  | RM35S0MW  |



## Current / Voltage /Frequency monitoring relays



| Function         | Voltage Monitoring Under or Over Voltage |            |            |
|------------------|--|------------|------------|
| Power Supply     | 24...240 VAC/DC 50/60Hz                  |            |            |
| Monitoring range | 0.05...0.5 V                             | 1...10 V   | 15...150 V |
|                  | 0.3...3 V                                | 5...50 V   | 30...300 V |
|                  | 0.5...5 V                                | 10...100 V | 60...600 V |
| Outputs          | 2 C/O                                    | 2 C/O      | 2 C/O      |
| References       | RM35UA11MW                               | RM35UA12MW | RM35UA13MW |

2



| Function         | Voltage Monitoring Under or Over Voltage |                |                 | Under and Over Voltage |                 |
|------------------|--|----------------|-----------------|------------------------|-----------------|
| Power Supply     | self powered                             |                |                 | self powered           |                 |
| Monitoring range | 9...15 VDC                               | 20...80 VAC/DC | 65...260 VAC/DC | 20...80 VAC/DC         | 65...260 VAC/DC |
| Outputs          | 1 C/O                                    | 1 C/O          | 1 C/O           | 1 C/O                  | 1 C/O           |
| References       | RM17UAS14                                | RM17UAS16      | RM17UAS15       | RM17UBE16              | RM17UBE15       |



| Function         | Current Monitoring      |   | Frequency Monitoring                    |
|------------------|-------------------------|---|---|
|                  | over current            | over or under current                   | Over or under frequency                 |
| Power supply     | 24...240 VAC/DC         | 24...240 VAC/DC 50/60 Hz                | 120...277 VAC 50/60 Hz                  |
| Monitoring range | 2...20 A<br>built-in CT | 2...20 mA<br>10...100 mA<br>50...500 mA | 0.15...1.5 A<br>0.5...5 A<br>1.5...15 A |
| Output           | 1 C/O                   | 2 C/O                                   | 2 C/O                                   |
| Reference        | RM17JC00MW              | RM35JA31MW                              | RM35JA32MW                              |
|                  |                         |   | RM35HZ21FM                              |

# Zelio Control Relays

## Lift / Pump / Motor monitoring relays



2

| Function         | Lift motor room temperature monitoring                        |                   | +phase presence<br>+phase sequence   |
|------------------|---|-------------------|--|
| Power supply     | 24...240 VAC/DC 50/60Hz                                       |                   |  |
| Monitoring range | input PT100 3 wires<br>Under -1...+11 °C<br>Over +34...+46 °C |                   | 208...480 VAC 50/60Hz<br>input PT100 3 wires<br>Under -1...+11 °C<br>Over +34...+46 °C |
| Output           | 1 C/O   | 2 NO              | 2 C/O  |
| Reference        | <b>RM35ATL0MW</b>   | <b>RM35ATR5MW</b> | <b>RM35ATW5MW</b>  |



| Function         | Pump protection<br>Current monitor<br>+3 phase monitor                 | Motor Protection<br>Winding Temperature monitor<br>+3 phase monitor           |                    |
|------------------|--|---|--------------------|
| Power supply     | self powered<br>(single phase :230 VAC 50/60 Hz)                       | 24...240 VAC/DC   |                    |
| Monitoring range | Current: 0.1...10 A<br>Voltage (three phase):<br>208...480 VAC 50/60Hz | Winding Temperature: PTC sensor<br>Three phase voltage: 208...480 VAC 50/60Hz |                    |
| Output           | 1 C/O  | 2 NO  | 2 NO               |
| Reference        | <b>RM35BA10</b>  | <b>RM35TM50MW</b>   | <b>RM35TM250MW</b> |

## Control relays for 3-phase supplies



| Function              | Rotational direction and presence of phases |               |                         |             |              |            |
|-----------------------|---|---------------|-------------------------|-------------|--------------|------------|
|                       |   | +Undervoltage | + Over and undervoltage | + Asymmetry |              |            |
| Adjustable time delay | without                                     | without       | 0.1...10 s              | 0.1...10 s  | fixed, 0.5 s | 0.1...10 s |
| Supply voltage        | 220...440V                                  | 380...440V    | 400V                    | 380...440V  | 380...440V   | 380...440V |
| Output                | 2 C/O                                       | 2 C/O         | 2 C/O                   | 2 C/O       | 1 C/O        | 2 C/O      |
| References            | RM4TG20                                     | RM4TU02       | RM4TR34 (1)             | RM4TR32 (2) | RM4TA02      | RM4TA32    |

(1) Relay with fixed voltage thresholds.

(2) Relay with adjustable voltage thresholds.

2

## Current and voltage measurement relays

(3) Basic reference. To be completed with the letters indicating the required voltage, as shown below:

| Voltage     | VAC, 50/60 Hz | VDC |
|-------------|---------------|-----|
| 24...240 V  | MW            | MW  |
| 110...130 V | F             | –   |
| 220...240 V | M             | –   |
| 380...415 V | Q             | –   |



| Function              | Detection of over and undercurrent |               |               |               |               |             |
|-----------------------|------------------------------------|---------------|---------------|---------------|---------------|-------------|
|                       |                                    |               |               |               |               |             |
| Measuring range       | 3...30 mA                          | 0.3...1.5 A   | 0.05 ...0.5 V | 1...10 V      | 30...300 V    | 180...270 V |
|                       | 10...100 mA                        | 1...5 A       | 0.3 ...3 V    | 5...50 V      | 50...500 V    |             |
| Adjustable time delay | 0.1...1 A                          | 3...15 A      | 0.5...5 V     | 10...100 V    |               |             |
|                       | 0.05...30 s                        | 0.05...30 s   | 0.05...30 s   | 0.05...30 s   | 0.05...30 s   | 0.1...10 s  |
| Output                | 2 C/O                              | 2 C/O         | 2 C/O         | 2 C/O         | 2 C/O         | 2 C/O       |
| References            | RM4JA31** (3)                      | RM4JA32** (3) | RM4UA31** (3) | RM4UA32** (3) | RM4UA33** (3) | RM4UB35     |

(4) Basic reference. To be completed with the letters indicating the required voltage, as shown below:

| Voltage     | RM4-LG01      | RM4-LA32      |     |
|-------------|---------------|---------------|-----|
|             | VAC, 50/60 Hz | VAC, 50/60 Hz | VDC |
| 24 V        | B             | B             | –   |
| 24...240 V  | –             | MW            | MW  |
| 110...130 V | F             | F             | –   |
| 220...240 V | M             | M             | –   |
| 380...415 V | Q             | Q             | –   |



## Liquid level control relays

| Control relays    | Empty or fill |   |
|-------------------|---------------|---|
| Sensitivity scale | 5 ... 100 kΩ  | 0.25 ... 5 kΩ<br>2.5 ... 50 kΩ<br>25 ... 500 kΩ |
| Time delay        | without       | adjustable, 0.1 to 10 s                         |
| Output            | 1 C/O         | 2 C/O   |
| References        | RM4LG01• (4)  | RM4LA32** (4)                                   |

| Liquid level control probe type | Measuring electrode and reference electrode | 1 simple stainless steel electrode in PVC protective casing |
|---------------------------------|---|---|
| Mounting                        | suspended                                   | suspended   |
| Maximum operating temperature   | 100°C                                       | 100°C   |
| References                      | LA9RM201                                    | RM79696043  |



| Type of relay        |                    |               | Size 24 x 48 mm - 1/32 DIN   |               |              |                                     |              |               |  |
|----------------------|--------------------|---------------|--|---------------|--------------|-------------------------------------|--------------|---------------|--|
| Input type           |                    |               | Thermocouple PT100 probe   |               |              | Voltage/Current 1...5 V / 4...20 mA |              |               |  |
| Integrated functions |                    |               | Hysteresis, PID, auto-tuning, fuzzy logic, rampe 8 steps, automatic operating mode |               |              |                                     |              |               |  |
| Alarm output         |                    |               | -  |               | 1            |                                     | -            |               |  |
| Communication        |                    |               | ModBus   |               | -            |                                     | ModBus       |               |  |
| Supply voltage       |                    |               | 100...240 VAC  |               |              | 24 V AC/DC                          |              | 100...240 VAC |  |
| References           | Number/Output type | 1/relay       | REG24PTP1RHU   | REG24PTP1ARHU | REG24PTP1RLU | REG24PUJ1RHU                        | REG24PUJ1RLU | REG24PUJ1LLU  |  |
|                      |                    | 1/solid-state | REG24PTP1LHU   | REG24PTP1ALHU | REG24PTP1LLU | REG24PUJ1LHU                        | REG24PUJ1LLU |               |  |
|                      |                    | 1/4-20 mA     | REG24PTP1JHU   | -             | REG24PTP1JLU | -                                   | -            |               |  |



| Type of relay        |                    |                           | Format 48 x 48 mm - 1/16 DIN   |               |               |               |               |  |
|----------------------|--------------------|---------------------------|--|---------------|---------------|---------------|---------------|--|
| Input type           |                    |                           | Universal  |               |               |               |               |  |
| Integrated functions |                    |                           | Hysteresis, PID, auto-tuning, fuzzy logic, rampe 16 steps, automatic and manual operating mode |               |               |               |               |  |
| Alarm output         |                    |                           | 2  |               |               |               |               |  |
| Communication        |                    |                           | ModBus   |               | -             |               | ModBus        |  |
| Supply voltage       |                    |                           | 100...240 VAC  |               |               | 24 V AC/DC    |               |  |
| References           | Number/Output type | 1/relay                   | REG48PUN1RHU   | REG48PUN1ARHU | REG48PUN1RLU  | REG48PUN1RHU  | REG48PUN1RLU  |  |
|                      |                    | 2/relay                   | REG48PUN2RHU   | -             | REG48PUN2RLU  | REG48PUN2RHU  | REG48PUN2RLU  |  |
|                      |                    | 1/solid-state             | REG48PUN1LHU   | REG48PUN1LHU  | REG48PUN1LLU  | REG48PUN1LHU  | REG48PUN1LLU  |  |
|                      |                    | 1 + 1 solid-state         | REG48PUN2RLHU  | -             | REG48PUN2RLLU | REG48PUN2RLHU | REG48PUN2RLLU |  |
|                      |                    | 1/4-20 mA                 | REG48PUN1JHU   | -             | REG48PUN1JLU  | REG48PUN1JHU  | REG48PUN1JLU  |  |
|                      |                    | 1/solid-state + 1/4-20 mA | REG48PUN2LJHU  | -             | REG48PUN2LJLU | REG48PUN2LJHU | REG48PUN2LJLU |  |



| Type of relay        |                    |                           | Size 96 x 48 mm - 1/8 DIN  |               |               |               |               |  |
|----------------------|--------------------|---------------------------|--|---------------|---------------|---------------|---------------|--|
| Input type           |                    |                           | Universal  |               |               |               |               |  |
| Integrated functions |                    |                           | Hysteresis, PID, auto-tuning, fuzzy logic, rampe 16 steps, automatic and manual operating mode |               |               |               |               |  |
| Alarm output         |                    |                           | 3  |               |               |               |               |  |
| Communication        |                    |                           | ModBus   |               | -             |               | ModBus        |  |
| Supply voltage       |                    |                           | 100...240 VAC  |               |               | 24 V AC/DC    |               |  |
| References           | Number/Output type | 1/relay                   | REG96PUN1RHU   | REG96PUN1ARHU | REG96PUN1RLU  | REG96PUN1RHU  | REG96PUN1RLU  |  |
|                      |                    | 2/relay                   | REG96PUN2RHU   | -             | REG96PUN2RLU  | REG96PUN2RHU  | REG96PUN2RLU  |  |
|                      |                    | 1/solid-state             | REG96PUN1LHU   | REG96PUN1LHU  | REG96PUN1LLU  | REG96PUN1LHU  | REG96PUN1LLU  |  |
|                      |                    | 1 + 1 solid-state         | REG96PUN2RLHU  | -             | REG96PUN2RLLU | REG96PUN2RLHU | REG96PUN2RLLU |  |
|                      |                    | 1/4-20 mA                 | REG96PUN1JHU   | -             | REG96PUN1JLU  | REG96PUN1JHU  | REG96PUN1JLU  |  |
|                      |                    | 1/solid-state + 1/4-20 mA | REG96PUN2LJHU  | -             | REG96PUN2LJLU | REG96PUN2LJHU | REG96PUN2LJLU |  |

# Zelio Count

## Counters Totalisers



| Display                      | Mechanical           |                      |                      |                      | LCD                  |
|------------------------------|----------------------|----------------------|----------------------|----------------------|----------------------|
| Supply voltage               | 24 VDC               |                      |                      |                      | Battery              |
| Number of digits displayed   | 5                    | 6                    | 6                    | 8                    | 8                    |
| Counting frequency           | 20 Hz                | 10 Hz                | 25 Hz                | 25 Hz                | 7.5 kHz              |
| Type of zero reset           | Manual               | Without              | Manual               | Without              | Manual (1)           |
| Front face dimensions, W x H | 41.5 x 31 mm         | 30 x 20 mm           | 60 x 50 mm           | 60 x 50 mm           | 48 x 24 mm           |
| References                   | <b>XBKT50000U10M</b> | <b>XBKT60000U00M</b> | <b>XBKT60000U10M</b> | <b>XBKT80000U00M</b> | <b>XBKT81030U33E</b> |

(1) With electrical interlocking.

2

## Hours counters



| Display                      | Mechanical           |                      | LCD                  |
|------------------------------|----------------------|----------------------|----------------------|
| Supply voltage               | 24 VAC               | 230 VAC              | Battery              |
| Number of digits / display   | 7 (99,999.99 h)      | 7 (99,999.99 h)      | 8 (999,999.99 h)     |
| Supply frequency             | 50 Hz                | 50 Hz                | Mode: 1/100 hour     |
| Type of zero reset           | Without              | Without              | Manual (1)           |
| Front face dimensions, W x H | 48 x 48 mm           | 48 x 48 mm           | 48 x 24 mm           |
| References                   | <b>XBKH70000004M</b> | <b>XBKH70000002M</b> | <b>XBKH81000033E</b> |

## Multifunction counters



| Display                      | LCD                             |         | LED                  |                      |                      |                      |
|------------------------------|---------------------------------|---------|----------------------|----------------------|----------------------|----------------------|
| Number of digits displayed   | 6                               |         |                      |                      |                      |                      |
| Counting frequency           | 5 kHz                           |         |                      |                      |                      |                      |
| Type of reset                | Manual, electric and automation |         |                      |                      |                      |                      |
| Front face dimensions, W x H | 48 x 48 mm                      |         |                      |                      |                      |                      |
| Preselection number          | 1                               | 2       | 1                    | 2                    |                      |                      |
| References                   | Supply voltage                  | 24 VDC  | <b>XBKP61130G30E</b> | <b>XBKP61230G30E</b> | <b>XBKP62130G30E</b> | <b>XBKP62230G30E</b> |
|                              |                                 | 115 VAC | <b>XBKP61130G31E</b> | <b>XBKP61230G31E</b> | –                    | –                    |
|                              |                                 | 230 VAC | <b>XBKP61130G32E</b> | <b>XBKP61230G32E</b> | <b>XBKP62130G32E</b> | <b>XBKP62230G32E</b> |



| Type of modular timer<br>width 17.5 mm, relay output | On-delay               | Multifunction          |               |                  |
|--|------------------------|------------------------|---------------|------------------|
| External control                                     | no                     | –                      | –             | –                |
| Supply voltage                                       | 24 VDC - 24 ...240 VAC | 24 VDC - 24 ...240 VAC | –             | 12 ... 240VAC/DC |
| Timing range   | 0.1 s...100 h          | 0.1 s...100 h          | 0.1 s...10 h  | 0.1 s...100 h    |
| Output   | 1 C/O                  | 1 C/O                  | 1 C/O         | 1 C/O            |
| References   | RE11RAMU               | RE11RMMU (1)           | RE11RMEMU (2) | RE11RMMW (1)     |

(1) Multifunction: On-delay, Off-delay, Totaliser, Symmetrical flashing, Chronometer, Pulse on energisation, Pulse output, Timing after closing/opening of control contact.

(2) Multifunction: On-delay, Off-delay, Totaliser, Symmetrical flashing, Chronometer, Pulse on energisation.



| Type of modular timer<br>width 17.5 mm, relay output | Asymmetrical flashing | Pulse on energisation | Off delay             | Timing on impulse     |
|--|-----------------------|-----------------------|-----------------------|-----------------------|
| External control                                     | –                     | –                     | –                     | –                     |
| Supply voltage                                       | 24 VDC - 24...240 VAC | 24 VDC - 24...240 VAC | 24 VDC - 24...240 VAC | 24 VDC - 24...240 VAC |
| Timing range   | 0.1 s...100 h         | 0.1 s...100 h         | 0.1 s...100 h         | 0.1 s...100 h         |
| Output   | 1 C/O                 | 1 C/O                 | 1 C/O                 | 1 C/O                 |
| References   | RE11RLMU              | RE11RHMU              | RE11RCMU              | RE11RBMU              |



| Type of modular timer<br>width 17.5 mm, solid-state output | On-delay        | Off-delay     | Multifunction (3) |
|--|-----------------|---------------|-------------------|
| Supply voltage   | 24...240 VAC/DC | 24...240 VAC  | 24...240 VAC      |
| Timing range   | 0.1 s...100 h   | 0.1 s...100 h | 0.1 s...100 h     |
| Output   | solid-state     | solid-state   | solid-state       |
| References   | RE11LAMW        | RE11LCBM      | RE11LMBM          |

(3) Multifunction: On-delay, Off-delay, Totaliser, Symmetrical flashing, Chronometer, Pulse on energisation, Pulse output, Timing after closing/opening of control contact.



| Panel-mounted relays | Timer on-delay                               | Asymmetrical flasher | Multifunction (4) | Multifunction (5) |
|----------------------|--|----------------------|-------------------|-------------------|
| Power supply         | 24...240 VAC/DC                              |                      |                   |                   |
| Time range           | 0,02 s...300 h                               |                      |                   |                   |
| Output               | 2 relay 5 A                                  |                      |                   |                   |
| Reference            | RE48ATM12MW                                  | RE48ACV12MW          | RE48AMH13MW (6)   | RE48AML12MW       |
|                      | Back panel mounting socket<br>RUZC2M         | RUZC3M               | RUZC2M            | RUZC3M            |
|                      | Front panel mounting socket<br>RE48ASOC8SOLD | RE48ASOC11SOLD       | RE48ASOC8SOLD     | RE48ASOC11SOLD    |

(4) Timer on-delay / pulse on energization

(5) Timer on-delay / calibrator / timer off-delay / symmetrical flasher

(6) 1 selectable in instantaneous

## Industrial timers



| Type of single function relay<br>width 22.5 mm, relay output | On-delay                   |  | Off-delay       |  |  |
|--|----------------------------|--|-----------------|--|--|
|  | no                         | yes  | no              | yes  | yes  |
| External control   | no                         | yes  | no              | yes  | yes  |
| Supply voltage   | 24 VAC/DC<br>110...240 VAC | 24 VAC/DC<br>42...48 VAC/DC<br>110...240 VAC | 24...240 VAC/DC | 24 VAC/DC<br>42...48 VAC/DC<br>110...240 VAC | 24 VAC/DC<br>42...48 VAC/DC<br>110...240 VAC |
| Timing range   | 0.05 s...300 h             | 0.05 s...300 h                               | 0.05 s...10 mn  | 0.05 s...300 h                               | 0.05 s...300 h                               |
| Output   | 1 C/O                      | 2 C/O (1)                                    | 1 C/O           | 2 C/O (1)                                    | 1 C/O  |
| References   | RE7TL11BU                  | RE7TP13BU                                    | RE7RB11MW       | RE7RL13BU                                    | RE7RM11BU                                    |

(1) 1 selectable in instantaneous mode.



| Type of relay<br>width 22.5 mm, relay output | Single function                              |                            | Multifunction                                |                            |
|--|--|----------------------------|--|----------------------------|
|  | Asymmetrical flashing                        | Pulse on energisation      | 6 functions (2)                              | 8 functions (3)            |
| External control                             | yes  | no                         | –  | –                          |
| Supply voltage                               | 24 VAC/DC<br>42...48 VAC/DC<br>110...240 VAC | 24 VAC/DC<br>110...240 VAC | 24 VAC/DC<br>42...48 VAC/DC<br>110...240 VAC | 24 VAC/DC<br>110...240 VAC |
| Timing range                                 | 0.05 s...300 h                               | 0.05 s...300 h             | 0.05 s...300 h                               | 0.05 s...300 h             |
| Output                                       | 1 C/O  | 1 C/O                      | 1 C/O  | 2 C/O (4)                  |
| References                                   | RE7CV11BU                                    | RE7PE11BU                  | RE7ML11BU                                    | RE7MY13BU                  |

(2) RE7ML11BU functions: On-delay, Off-delay, Pulse on energisation with start on energisation, Pulse on energisation with start on opening of remote control contact, Flashing with start during the OFF period, Flashing with start during the ON period.

(3) REMY13BU functions: On-delay, Off-delay, Pulse on energisation with start on energisation, Pulse on energisation with start on opening of remote control contact, Flashing with start during the OFF period, Flashing with start during the ON period, Star-delta starting with double On-delay timing, Star-delta starting with contact for switching to star connection.

(4) 1 selectable in instantaneous mode

## Miniature plug-in relays, relay output



| Functions                           |                     |   |  |                      |
|-------------------------------------|---------------------|---|--|----------------------|
| Timing ranges                       | 7 switchable ranges | 0.1 s...1 s - 1 s...10 s - 0.1 min...1 min - 1 min...10 min - 0.1 h...1 h - 1 h...10 h - 10 h...100 h |  |                      |
| Relay output                        |                     | 4 timed C/O contacts  |  | 2 timed C/O contacts |
| Rated current                       |                     | 3 AC 5 A  |  | AC 5 A               |
| Voltages                            | 24 VDC              | RE XL4TMBD  |  | RE XL2TMBD           |
|                                     | 24 VAC 50/60 Hz     | RE XL4TMB7  |  | RE XL2TMB7           |
|                                     | 120 VAC 50/60 Hz    | RE XL4TMF7  |  | RE XL2TMF7           |
|                                     | 230 VAC 50/60 Hz    | RE XL4TMP7  |  | RE XL2TMP7           |
| Socket with mixed contact terminals | With screw clamp    | RXZE2M114   |  | RXZE2M114            |
|                                     | With connector      | RXZE2M114M  |  | RXZE2M114M           |



2

| Type                 | Thermocouple                                |                           |                            |                            |                             |
|----------------------|---|---------------------------|----------------------------|----------------------------|-----------------------------|
| Temperature range    | 0...150 °C<br>32...302 °F                   | 0...300 °C<br>32...572 °F | 0...600 °C<br>32...1112 °F | 0...600 °C<br>32...1112 °F | 0...1200 °C<br>32...2192 °F |
| Output range         | 0...10 V / 0...20 mA - 4...20 mA Switchable |                           |                            |                            |                             |
| Dimensions H x W x D | 80 x 22,5 x 80 mm                           |                           |                            |                            |                             |
| Voltage              | 24 VDC - Non isolated                       |                           |                            |                            |                             |
| References           | RMTJ40BD                                    | RMTJ60BD                  | RMTJ80BD                   | RMTK80BD                   | RMTK90BD                    |

## Universal PT 100



| Type                 | PT 100                                      |                                |                           |                           |                           |
|----------------------|---|--------------------------------|---------------------------|---------------------------|---------------------------|
| Temperature range    | -40...40 °C<br>-40...104 °F                 | -100...100 °C<br>-148...212 °F | 0...100 °C<br>32...212 °F | 0...250 °C<br>32...482 °F | 0...500 °C<br>32...932 °F |
| Output range         | 0...10 V / 0...20 mA - 4...20 mA Switchable |                                |                           |                           |                           |
| Dimensions H x W x D | 80 x 22,5 x 80 mm                           |                                |                           |                           |                           |
| Voltage              | 24 VDC - Non isolated                       |                                |                           |                           |                           |
| References           | RMPT10BD                                    | RMPT20BD                       | RMPT30BD                  | RMPT50BD                  | RMPT70BD                  |



## Optimum PT 100



| Type                 | PT 100                      |                                |                           |                           |                           |
|----------------------|-----------------------------|--------------------------------|---------------------------|---------------------------|---------------------------|
| Temperature range    | -40...40 °C<br>-40...104 °F | -100...100 °C<br>-148...212 °F | 0...100 °C<br>32...212 °F | 0...250 °C<br>32...482 °F | 0...500 °C<br>32...932 °F |
| Output range         | 0...10 V                    |                                |                           |                           |                           |
| Dimensions H x W x D | 80 x 22,5 x 80 mm           |                                |                           |                           |                           |
| Voltage              | 24 VDC - Non isolated       |                                |                           |                           |                           |
| References           | RMPT13BD                    | RMPT23BD                       | RMPT33BD                  | RMPT53BD                  | RMPT73BD                  |

2

## Universal Analog Converter



| Type                 | Analog Converter      |   |   |                                       |
|----------------------|-----------------------|---|---|---------------------------------------|
| Input range          | 0...10 V or 4...20 mA | 0...10 V / -10...+10 V<br>0...20 mA<br>4...20 mA            | 0...50 V / 0...300 V<br>0...500 V             | 0...1,5 A / 0...5 A<br>0...15 A       |
| Output range         | 0...10 V or 4...20 mA | 0...10 V / -10...+10 V<br>0...20 mA<br>4...20 mA Switchable | 0...10 V<br>0...20 mA<br>4...20 mA Switchable | 0...10 V or 0...20 mA<br>ou 4...20 mA |
| Dimensions H x W x D | 80 x 22,5 x 80 mm     |   |   | 80 x 45 x 80 mm                       |
| Voltage              | 24 VDC - Non isolated | 24 VDC - Isolated   | 24 VDC - Isolated                             | 24 VDC - Isolated                     |
| References           | RMCN22BD              | RMCL55BD  | RMCV60BD                                      | RMCA61BD                              |



| Compact smart relays       |                 | With display, a.c. power supply |                  |          |                 |           |                  |           |
|----------------------------|-----------------|---------------------------------|------------------|----------|-----------------|-----------|------------------|-----------|
| Supply voltage             |                 | 24 VAC                          |                  | 48 VAC   | 100...240 VAC   |           |                  |           |
| Number of inputs/outputs   |                 | 12                              | 20               | 20       | 10              | 12        | 20               | 20        |
| Number of inputs           | Discrete inputs | 8                               | 12               | 12       | 6               | 8         | 12               | 12        |
| Number of outputs          |                 | 4 relay                         | 8 relay          | 8 relay  | 4 relay         | 4 relay   | 8 relay          | 8 relay   |
| Dimensions, W x D x H (mm) |                 | 71.2x59.5x107.6                 | 124.6x59.5x107.6 |          | 71.2x59.5x107.6 |           | 124.6x59.5x107.6 |           |
| Clock                      |                 | yes                             | yes              | no       | no              | yes       | no               | yes       |
| References                 |                 | SR2B121B                        | SR2B201B         | SR2A201E | SR2A101FU (1)   | SR2B121FU | SR2A201FU (1)    | SR2B201FU |

(1) Programming on smart relay in LADDER language only



| Compact smart relays       |                                  | With display, d.c. power supply |                  |                 |               |                  |               |
|----------------------------|----------------------------------|---------------------------------|------------------|-----------------|---------------|------------------|---------------|
| Supply voltage             |                                  | 12 VDC                          |                  | 24 VDC          |               |                  |               |
| Number of inputs/outputs   |                                  | 12                              | 20               | 10              | 12            | 20               | 20            |
| Number of inputs           | Discrete inputs                  | 8                               | 12               | 6               | 8             | 12               | 12            |
|                            | including 0-10 V analogue inputs | 4                               | 6                | -               | 4             | 2                | 6             |
| Number of outputs          |                                  | 4 relay                         | 8 relay          | 4 relay         | 4             | 8 relay          | 8             |
| Dimensions, W x D x H (mm) |                                  | 71.2x59.5x107.6                 | 124.6x59.5x107.6 | 71.2x59.5x107.6 |               | 124.6x59.5x107.6 |               |
| Clock                      |                                  | yes                             | yes              | no              | yes           | no               | yes           |
| References                 |                                  | SR2B121JD                       | SR2B201JD        | SR2A101BD (1)   | SR2B12●BD (2) | SR2A201BD (1)    | SR2B20●BD (2) |

(1) Programming on smart relay in LADDER language only

(2) Replace the ● by number 1 to order a smart relay with **relay output** or by 2 for a smart relay with **transistor output** (Example: SR2B121BD)



| Compact smart relays              |                                  | Without display and without buttons |           |                  |                 |               |                  |
|-----------------------------------|----------------------------------|-------------------------------------|-----------|------------------|-----------------|---------------|------------------|
| Supply voltage                    |                                  | 100...240 VAC                       |           |                  | 24 VDC          |               |                  |
| Number of discrete inputs/outputs |                                  | 10                                  | 12        | 20               | 10              | 12            | 20               |
| Number of inputs                  | Discrete inputs                  | 6                                   | 8         | 12               | 6               | 8             | 12               |
|                                   | including 0-10 V analogue inputs | -                                   | -         | -                | -               | 4             | 6                |
| Number of outputs                 |                                  | 4 relay                             | 4 relay   | 8 relay          | 4 relay         | 4 relay       | 8 relay          |
| Dimensions, W x D x H (mm)        |                                  | 71.2x59.5x107.6                     |           | 124.6x59.5x107.6 | 71.2x59.5x107.6 |               | 124.6x59.5x107.6 |
| Clock                             |                                  | no                                  | yes       | yes              | no              | yes           | yes              |
| References                        |                                  | SR2D101FU (1)                       | SR2E121FU | SR2E201FU        | SR2D101BD (1)   | SR2E121BD (3) | SR2E201BD (3)    |

(1) Programming on smart relay in LADDER language only

(3) To order a smart relay for a **24 VAC supply** (no analogue inputs), delete the letter **D** from the end of the reference (**SR2E121B** and **SR2E201B**)

## Modular, SR3



| Modular smart relays*      | With display                     |                  |                                  |                  |                                  |                                  |                  |
|----------------------------|----------------------------------|------------------|----------------------------------|------------------|----------------------------------|----------------------------------|------------------|
|                            | 24 VAC                           |                  | 100...240 VAC                    |                  | 12 VDC                           | 24 VDC                           |                  |
| Supply voltage             | 24 VAC                           |                  | 100...240 VAC                    |                  | 12 VDC                           | 24 VDC                           |                  |
| Number of inputs/outputs   | 10                               | 26               | 10                               | 26               | 26                               | 10                               | 26               |
| Number of inputs           | Discrete inputs                  |                  | Discrete inputs                  |                  | Discrete inputs                  | Discrete inputs                  |                  |
|                            | 6                                | 16               | 6                                | 16               | 16                               | 6                                | 16               |
|                            | including 0-10 V analogue inputs |                  | including 0-10 V analogue inputs |                  | including 0-10 V analogue inputs | including 0-10 V analogue inputs |                  |
| Number of outputs          | 4 relay                          | 10 relay         | 4 relay                          | 10 relay         | 6                                | 4                                | 6                |
| Dimensions, W x D x H (mm) | 71.2x59.5x107.6                  | 124.6x59.5x107.6 | 71.2x59.5x107.6                  | 124.6x59.5x107.6 | 124.6x59.5x107.6                 | 71.2x59.5x107.6                  | 124.6x59.5x107.6 |
| Clock                      | yes                              | yes              | yes                              | yes              | yes                              | yes                              | yes              |
| References                 | SR3B101B                         | SR3B261B         | SR3B101FU                        | SR3B261FU        | SR3B261JD                        | SR3B10BD (1)                     | SR3B26BD (1)     |

\*The modular base can be fitted with one I/O extension module. The 24 VDC modular base can be fitted with one communication module and/or one I/O extension module

(1) Replace the ● by number 1 to order a smart relay with relay output (SR3B101BD) or by 2 for a smart relay with transistor output (SR3B102BD)



| Extension modules for Zelio Logic SR3B●●●●● (2) | Communication                         |          | Discrete Inputs/Outputs |               |            | Analogue Inputs/Outputs |            |
|---|---------------------------------------|----------|-------------------------|---------------|------------|-------------------------|------------|
|   | Modbus                                | Ethernet | 6                       | 10            | 14         | 4                       |            |
| Network   | –                                     | –        | –                       | –             | –          | –                       |            |
| Number of inputs/outputs                        | –                                     | –        | 6                       | 10            | 14         | 4                       |            |
| Number of inputs                                | Discrete                              |          | 4                       | 6             | 8          | –                       |            |
|   | Analogue (0...10 V, 0...20 mA, PT100) |          | –                       | –             | –          | 2 (1 PT100 max.)        |            |
| Number of outputs                               | Relay                                 |          | 2 relay                 | 4 relay       | 6 relay    | –                       |            |
|   | Analogue (0...10 V)                   |          | –                       | –             | –          | 2                       |            |
| Dimensions, W x D x H (mm)                      | 35.5x59.5x107.6                       |          | 35.5x59.5x107.6         | 72x59.5x107.6 | –          | 35.5x59.5x107.6         |            |
| References                                      | 24 VAC                                |          | SR3XT61B                | SR3XT101B     | SR3XT141B  | –                       |            |
|   | 100...240 VAC                         |          | SR3XT61FU               | SR3XT101FU    | SR3XT141FU | –                       |            |
|   | 12 VDC                                |          | SR3XT61JD               | SR3XT101JD    | SR3XT141JD | –                       |            |
|   | 24 VDC                                |          | SR3MBU01BD              | SR3NET01BD    | SR3XT61BD  | SR3XT101BD              | SR3XT141BD |
|   |                                       |          |                         |               |            | SR3XT43BD               |            |

(2) The power supply of the extension modules is provided via the Zelio Logic modular relays

## Zelio Soft 2 software and programming tools



| Zelio Soft 2 software, connecting cables, wireless connecting, memory | Multilingual programming software                               | Connecting cables     |                    |                   |                  | Wireless connection | Back-up memory |
|---|---|-----------------------|--------------------|-------------------|------------------|---------------------|----------------|
| Description   | CD ROM PC (Windows XP, Vista 32 bits and Windows 7 32 bits) (3) | Serial PC/Smart relay | USB PC/Smart relay | XBT N/R Interface | HMISTO Interface | Bluetooth interface | EEPROM         |
| References  | SR2SFT01  | SR2CBL01              | SR2USB01           | SR2CBL08          | SR2CBL09         | SR2BTC01            | SR2MEM02       |

(3) CD-ROM including Zelio Soft 2 programming software, an application library, a self-training manual, installation instructions and a user's manual

## Communication interface for SR2/SR3

| Interface, modems, Zelio Logic Alarm software | Communication interface | Modems (4)     |                | Alarm management software            |
|---|-------------------------|----------------|----------------|--------------------------------------|
| Supply voltage                                | 12...24 VDC             | 12...24 VDC    | 12...24 VDC    | –                                    |
| Description                                   | –                       | Analogue modem | GSM modem      | PC CD-ROM (Windows 98, NT, 2000, XP) |
| Dimensions, W x D x H (mm)                    | 72x59.5x107.6           | 120.7x35x80.5  | 111x 25.5x54.5 | –                                    |
| References                                    | SR2COM01                | SR2MOD01       | SR2MOD02       | SR2SFT02                             |

(4) Must be used in conjunction with communication interface SR2COM01



| Type de base                      |                              | Compact                                    |   |                     |  |
|-----------------------------------|------------------------------|--|---|---------------------|--|
|                                   |                              | Non expandable bases                       |   | Expandable bases    |  |
| Number of digital I/O             |                              | 10   | 16  | 24                  | 40                                     |
| Number of digital inputs (24 VDC) |                              | 6 sink/source                              | 9 sink/source                             | 14 sink/source      | 24 sink/source                         |
| Number of digital outputs         |                              | 4 relay (2 A)                              | 7 relay (2 A)                             | 10 relay (2 A)      | 14 relay (2 A),<br>2 solid-state (1 A) |
| Type of connection                |                              | Screw terminals (non removable)            |   |                     |  |
| Possible I/O expansion modules    |                              | –  | –   | 4                   | 7                                      |
| Counting                          |                              | 3 x 5 kHz, 1 x 20 kHz                      |   |                     |  |
| PWM positioning                   |                              | –  |   |                     |  |
| Serial ports                      |                              | 1 x RS 485                                 | 1 x RS 485; option: 1 x RS 232C or RS 485 |                     |  |
| Protocol                          |                              | Modbus master/slave, ASCII, I/O relocation |   |                     |  |
| Ethernet port                     |                              | –  | –   | –                   | RJ45 Ethernet                          |
| Dimensions, W x D x H             |                              | 80 x 70 x 90 mm                            | 80 x 70 x 90 mm                           | 95 x 70 x 90 mm     | 157 x 70 x 90 mm                       |
| References                        | Supply voltage 100...240 VAC | <b>TWDLCAA10DRF</b>                        | <b>TWDLCAA16DRF</b>                       | <b>TWDLCAA24DRF</b> | <b>TWDLCAE40DRF (1)</b>                |
|                                   | Supply voltage 19.2...30 VDC | <b>TWDLCAA10DRF</b>                        | <b>TWDLCAA16DRF</b>                       | <b>TWDLCAA24DRF</b> | <b>TWDLCAE40DRF (1)</b>                |
|                                   | Real-time clock (option)     | <b>TWDXCPRTC</b>                           |   |                     |  |
|                                   | Display unit (option)        | <b>TWDXCPODC</b>                           |   |                     |  |
|                                   | Memory cartridge (option)    | <b>TWDXCPMFK32 (3)</b>                     |   |                     | <b>TWDXCPMFK64 (4)</b>                 |

(1) 40 I/O version without Ethernet also available: TWDLCAA40DRF and TWDLCAE40DRF

## Modular bases



| Type of base                      |                           | Modular                                    |  |                               |
|-----------------------------------|---------------------------|--|--|-------------------------------|
| Number of digital I/O             |                           | 20   |  | 40                            |
| Number of digital inputs (24 VDC) |                           | 12 sink/source                             | 12 sink/source                           | 24 sink/source                |
| Number of digital outputs         |                           | 8 transistor, source (0.3 A)               | 6 relay (2 A) & 2 trans., source (0.3 A) | 16 transistor, source (0.3 A) |
| Type of connection                |                           | HE10 connector                             | Removable screw terminals                | HE10 connector                |
| Possible I/O expansion modules    |                           | 4  | 7  | 7                             |
| Supply voltage                    |                           | 24 VDC                                     |  |                               |
| Counting                          |                           | 2 x 5 kHz, 2 x 20 kHz                      |  |                               |
| PLS/PWM positioning               |                           | 2 x 7 kHz                                  |  |                               |
| Serial ports                      |                           | 1 x RS 485; option: 1 x RS 232C or RS 485  |  |                               |
| Protocol                          |                           | Modbus master/slave, ASCII, I/O relocation |  |                               |
| Dimensions, W x D x H             |                           | 35.4 x 70 x 90 mm                          | 47.5 x 70 x 90 mm                        | 47.5 x 70 x 90 mm             |
| References                        |                           | <b>TWDLMDA20DTK (2)</b>                    | <b>TWDLMDA20DRT</b>                      | <b>TWDLMDA40DTK (2)</b>       |
|                                   | Real-time clock (option)  | <b>TWDXCPRTC</b>                           |  |                               |
|                                   | Display unit (option)     | <b>TWDXCPODM</b>                           |  |                               |
|                                   | Memory cartridge (option) | <b>TWDXCPMFK32 (3)</b>                     | <b>TWDXCPMFK64 (4)</b>                   |                               |

(2) Sink version transistor outputs also available: TWDLMDA20DUK and TWDLMDA40DUK

(3) Application backup, program transfer

(4) Memory expansion, application backup, program transfer

## I/O expansion modules

For I/O expansion modules, please consult Modicon TM2 page 2/21

## Communication modules



| Type of module           | Serial interface                           |                 |            | Serial interface adaptor   |                 |            |
|--------------------------|--|-----------------|------------|--|-----------------|------------|
|                          | Physical layer (non isolated)              | RS 232C         | RS 485     |  | RS 232C         | RS 485     |
| Connection               | Mini-DIN connector                         | Screw terminals |            | Mini-DIN connector   | Screw terminals |            |
| Protocol                 | Modbus master/slave, ASCII, I/O relocation |                 |            |  |                 |            |
| Twido base compatibility | Modular base TWDLMDA                       |                 |            | Compact base TWDLCAA16/24DRF<br>Modular base via integrated display module TWDXCPODM |                 |            |
| References               | TWDNOZ232D                                 | TWDNOZ485D      | TWDNOZ485T | TWDNAC232D   | TWDNAC485D      | TWDNAC485T |

2



| Type of module           | Modem for Twido | CANopen expansion     | Ethernet interface | Modbus isolation module | Modbus junction module |
|--------------------------|-----------------|-----------------------|--------------------|-------------------------|------------------------|
| Number of modules        | –               | 1                     | 1                  | –                       | –                      |
| Connection               | –               | SUB-D9                | RJ45               | RJ45                    | RJ45                   |
| Twido base compatibility | –               | 20, 24 or 40 I/O base | All models         | All models              | All models             |
| References               | SR2MOD03        | TWDNCO1M              | 499TWD01100        | TWDXCAISO               | TWDXCAT3RJ             |

(1) 2 modules max., 62 digital slaves max., 7 analogue slaves max., AS-Interface/M3, V 2.11 (profile S.7.4 not supported)

## Programming software



| Software, connecting cables, interfaces | TwidoSuite software EN/FR   | Connecting cables        |                      | Bluetooth® USB adaptor            | Bluetooth® gateway   |
|---|-----------------------------|--------------------------|----------------------|-----------------------------------|----------------------|
| Application                             | PC with Windows XP or Vista | Twido/PC USB port        | Twido/PC serial port | For PC not fitted with Bluetooth® | For Twido controller |
| References                              | TWDBTFU10M                  | TSXCUSB485<br>TSXCRJMD25 | TSXPCX1031           | VW3A8115                          | VW3A8114             |



SoMachine



| Type of base                           | Compact  |                         |   |                         |
|--|--|-------------------------|---|-------------------------|
| Number of digital I/O                  | 24 (removable battery to be ordered separately)  |                         |   |                         |
| Supply voltage                         | 24VDC  | 100-240VAC              | 24VDC   | 100-240VAC              |
| Number of digital inputs (24VDC)       | 14, 8 of which can be assigned as fast inputs  |                         |   |                         |
| Number of digital outputs              | 10 transistor, 4 of which can be configured as fast outputs  | 4 transistor + 6 relays | 10 transistor, 4 of which can be configured as fast outputs | 4 transistor + 6 relays |
| Type of connection                     | Removable screw terminal blocks (as standard)<br>Removable spring terminal blocks (as option)                          |                         |   |                         |
| Possible I/O expansion modules         | 7 modules: digital, analog, high-speed counter (3 max.), master AS-Interface (2 max.)                                  |                         |   |                         |
| High-speed counting (32 bits capacity) | 8 x 100kHz simple channels, 4 x 100kHz simple channels + 1 x 100kHz advanced channels, or 2 x 100kHz advanced channels |                         |   |                         |
| Motion or reflex functions             | 2 advanced channels, PWM:20kHz, PTO: 100kHz  |                         | 4 advanced channels HSC reflex functions:100kHz             |                         |
| PID Regulation                         | Yes  |                         |   |                         |
| Serial Ports                           | 1 RS 232/485 (SL1) serial link   |                         | 1 RS232/485 (SL1) serial link, 1 RS485 (SL2) serial link    |                         |
| CANopen                                | -  |                         | 1 master for 16 slaves max.                                 |                         |
| Dimensions, W x D x H                  | 157 x 86 x 118 mm  |                         |   |                         |
| References                             | TM238LDD24DT   | TM238LDA24DR            | TM238LFDC24DT   | TM238LFAC24DR           |

## High-speed counting modules



| Type of module                     | High-speed counting          |                               |
|------------------------------------|------------------------------|-------------------------------|
| Modularity                         | 2 channels                   |                               |
| Maximum number of modules per base | 3                            |                               |
| Number of sensor inputs            | 6 per channel                |                               |
| Number of actuator outputs         | 2 per channel                |                               |
| Capacity                           | 31 bits + sign               |                               |
| Frequency on inputs                | 60kHz                        |                               |
| Connection                         | 1 screw terminal per channel | 1 spring terminal per channel |
| References                         | TM200HSC206DT                | TM200HSC206DF                 |

## Communication module and accessory



| Designation                        | Ethernet interface  | Program loader   |
|------------------------------------|---------------------|--|
| Description                        | Ethernet Modbus/TCP | Kit: program loader, cable (USB/mini-B USB), 2 batteries (type AA/LR6) |
| Maximum number of modules per base | 1                   | -  |
| References                         | 499TWD01100         | TM2USBABDEV1   |

(1) Requires the use of a USB memory stick (not supplied)



| Type of module        |            | Analog inputs              |                               |                                       |                               |           |                             |                 |
|-----------------------|------------|----------------------------|-------------------------------|---------------------------------------|-------------------------------|-----------|-----------------------------|-----------------|
| Number of inputs      |            | 2 I                        | 2 I                           | 4 I                                   | 8 I                           | 8 I       | 8 I                         | 8 I             |
| Connection            |            | Removable screw terminals  |                               |                                       |                               |           |                             |                 |
| Inputs                |            | RJ11                       |                               |                                       |                               |           |                             |                 |
| Inputs                | Range      | Thermocouples type K, J, T | 0...10 V (1)<br>4...20 mA (2) | 0...10 V (1)<br>0...20 mA (2)<br>θ °C | 0...10 V (1)<br>0...20 mA (2) | PTC/NTC   | Thermo probe Pt100 / Pt1000 | -200...+ 600 °C |
|                       | Resolution | 12 bits (4096 points)      |                               |                                       | 10 bits (1024 points)         |           | 12 bits (4096 points)       |                 |
| Supply voltage        |            | 24 VDC                     |                               |                                       |                               |           |                             |                 |
| Dimensions, W x D x H |            | 23.5 x 70 x 90 mm          |                               |                                       |                               |           | 39.1x70x90 mm               |                 |
| References            |            | TM2AMI2LT                  | TM2AMI2HT                     | TM2AMI4LT                             | TM2AMI8HT                     | TM2ARI8HT | TM2ARI8LT                   | TM2ARI8LRJ      |

(1) Non differential

(2) Differential



| Type of module                  |            | Analog Outputs, Inputs/Outputs (mixed) |                |                               |   |                               |
|---------------------------------|------------|--|----------------|-------------------------------|---|-------------------------------|
| Number of inputs and/or outputs |            | 1 O                                    | 2 O            | 2 I / 1 O                     | 2 I / 1 O   | 4 I / 2 O                     |
| Connection                      |            | Removable screw terminals              |                |                               |   |                               |
| Inputs                          | Range      | –                                      | –              | 0...10 V (1)<br>4...20 mA (2) | Thermocouple type K, J & T<br>3-wire Pt 100 thermal probe | 0...10 V (1)<br>4...20 mA (2) |
|                                 | Resolution | –                                      | –              | 12 bits (4096 points)         | 12 bits (4096 points)                                     | 12 bits (4096 points)         |
| Outputs                         | Range      | 0...10 V (1)<br>4...20 mA (2)          | ± 10 V         | 0...10 V (1)<br>4...20 mA (2) | 0...10 V (1)<br>4...20 mA (2)                             | 0...10 V (1)<br>4...20 mA (2) |
|                                 | Resolution | 12 bits                                | 11 bits + sign | 12 bits                       | 12 bits   | 12 bits                       |
| Supply voltage                  |            | 24 VDC                                 |                |                               |   |                               |
| Dimensions, W X D x H           |            | 23.5 x 70 x 90 mm                      |                |                               |   |                               |
| References                      |            | TM2AMO1HT                              | TM2AVO2HT      | TM2AMM3HT                     | TM2ALM3LT   | TM2AMM6HT                     |

(1) Non differential

(2) Differential



| Type of module                  |                                      | Digital Inputs/Outputs    |           |            |                 |            |                           |                                  |
|---------------------------------|--------------------------------------|---------------------------|-----------|------------|-----------------|------------|---------------------------|----------------------------------|
| Number of inputs and/or outputs |                                      | 8                         | 16        | 16         | 32              | 4 I / 4 O  | 16 I / 8 O                |                                  |
| Connection                      |                                      | Removable screw terminals |           |            | HE10 connectors |            | Removable screw terminals | Spring terminals (non removable) |
| References                      | Inputs                               | 24 VDC sink               | TM2DDI8DT | –          | –               | –          | –                         |                                  |
|                                 |                                      | 24 VDC sink/source        | –         | TM2DDI16DT | TM2DDI16DK      | TM2DDI32DK | –                         |                                  |
|                                 |                                      | 120 V sink                | TM2DAI8DT | –          | –               | –          | –                         |                                  |
|                                 | Outputs                              | Relay (2 A)               | TM2DRA8RT | TM2DRA16RT | –               | –          | –                         |                                  |
|                                 |                                      | Transistor, source 0.5 A  | TM2DDO8TT | –          | –               | –          | –                         |                                  |
|                                 |                                      | Transistor, source 0.4 A  | –         | –          | TM2DDO16TK      | TM2DDO32TK | –                         |                                  |
|                                 |                                      | Transistor, sink 0.1 A    | TM2DDO8UT | –          | TM2DDO16UK      | TM2DDO32UK | –                         |                                  |
|                                 | Inputs, 24 VDC + Outputs, Relais 2 A |                           | –         | –          | –               | –          | TM2DMM8DRT                | TM2DMM24DRF                      |



SoMachine



| Controller type                  |  | 42 digital I/O   | 42 digital I/O & CANopen |
|----------------------------------|--|--|--------------------------|
| Internal memory                  | RAM  | 64 MB  |                          |
|                                  | Flash Eeprom   | 128 MB   |                          |
| Typical Boolean instruction time |  | 22 ns  |                          |
| User program size                |  | 128 program K instructions   |                          |
| Power supply                     |  | 24 V DC  |                          |
| Inputs                           | Digital  | 26 inputs 24VDC including 8 counter inputs (200 kHz)                                     |                          |
|                                  | Analog   | -  |                          |
| Outputs                          | Transistor   | 16 outputs (0,5A) including 4 reflex outputs (100 kHz)                                   |                          |
|                                  | Relay  | -  |                          |
| Optional communication ports     |  | -  |                          |
| Communication                    | USB-B mini-port  | Programming port for SoMachine software  |                          |
|                                  | USB-A port   | Connection of a USB memory stick for transferring programs, data files, firmware updates |                          |
|                                  | RJ45 port (MBS)  | RS232 serial link  |                          |
|                                  |  | RS485 serial link (supplies 250 mA, 5 V for HMI power supply)                            |                          |
|                                  |  | Protocols: Modbus ASCII/RTU Master/Slave, ASCII (character string)                       |                          |
| SUB-D connector (CAN0)           | -  | CANopen bus master (63 slaves)   |                          |
| RJ45 port (Ethernet)             | Ethernet TCP, Ethernet IP, FTP server, Web server, Ethernet Modbus TCP |  |                          |
| Max. number of expansions        |  | 250 modules (local or remote) for digital IO, analog IO or Expert functions              |                          |
| References                       |  | <b>TM258LD42DT</b>   | <b>TM258LF42DT</b>       |















| Controller type                  |  | 42 digital I/O relays & CANopen  | 66 digital I/O & CANopen & 4 analog inputs                       |
|----------------------------------|--|--|--|
| Internal memory                  | RAM  | 64 MB  |  |
|                                  | Flash Eeprom   | 128 MB   |  |
| Typical Boolean instruction time |  | 22 ns  |  |
| User program size                |  | 128 program K instructions   |  |
| Power supply                     |  | 24 V DC  |  |
| Inputs                           | Digital  | 26 inputs 24VDC including 8 counter inputs (200 kHz)                                     | 38 inputs 24VDC including 8 counter inputs (200 kHz)             |
|                                  | Analog   | -  | 4 analog inputs +10 V/-10V, 4-20mA/0-20 mA<br>12 bits resolution |
| Outputs                          | Transistor   | 4 reflex outputs (100 kHz)   | 28 outputs (0,5A) including 4 reflex outputs (100 kHz)           |
|                                  | Relay  | 12 relays  | -  |
| Optional communication ports     |  | 2 PCI slots for optional communication modules   |  |
| Communication                    | USB-B mini-port  | Programming port for SoMachine software  |  |
|                                  | USB-A port   | Connection of a USB memory stick for transferring programs, data files, firmware updates |  |
|                                  | RJ45 port (MBS)  | RS232 serial link  |  |
|                                  |  | RS485 serial link (supplies 250 mA, 5 V for HMI power supply)                            |  |
|                                  |  | Protocols: Modbus ASCII/RTU Master/Slave, ASCII (character string)                       |  |
| SUB-D connector (CAN0)           | CANopen bus master (63 slaves)   |  |  |
| RJ45 port (Ethernet)             | Ethernet TCP, Ethernet IP, FTP server, Web server, Ethernet Modbus TCP |  |  |
| Max. number of expansions        |  | 250 modules (local or remote) for digital IO, analog IO or Expert functions              |  |
| References                       |  | <b>TM258LF42DR</b>   | <b>TM258LF66DT4L</b>   |



# Modicon TM5 I/O expansion modules for Modicon M258 and Modicon LMC058 <sup>(1)</sup>



| Type of module                           | Input   |   |   | Output  |   |   | Input Output Digital |
|--|---|---|---|---|---|---|----------------------|
|  | Digital   | Analog  |   | Digital   | Analog  |   |                      |
| Number of inputs                         | 12 sink   | –   | –   | –   | –   | –   | 24                   |
| Number of outputs                        | –   | –   | –   | 12 source   | 4 relay   | –   | 18                   |
| Number of inputs                         | –   | 4   | 4   | –   | –   | –   | –                    |
| Number of outputs                        | –   | –   | –   | –   | –   | 4   | –                    |
| Nominal input current                    | 24 VDC  | –   | –   | –   | –   | –   | 24 VDC               |
| Nominal output current                   | –   | –   | –   | 24 VDC  | 30 VDC/ 230 VAC   | –   | 24 VDC               |
| Type                                     | –   | Thermal probe   | Voltage / Current   | –   | –   | Voltage / Current   | –                    |
| Associated bus sub-bases <sup>(2)</sup>  |   |   |   |   |   |   | –                    |
|  | TM5ACBM11   | TM5ACBM11   | TM5ACBM11   | TM5ACBM11   | TM5ACBM12   | TM5ACBM11   |                      |
| Associated terminal block <sup>(2)</sup> |  |  |  |  |  |  | –                    |
|  | TM5ACTB12   | TM5ACTB12   | TM5ACTB12   | TM5ACTB12   | TM5ACTB32   | TM5ACTB12   |                      |
| References                               | TM5SDI12D   | TM5SAI4PH   | TM5SAI4L  | TM5SDO12T   | TM5SDO4R  | TM5SAO4L  | TM5C24D18T           |

<sup>(1)</sup> Modicon M258 and Modicon LMC058 controllers offer the possibility of creating IP20 or IP67 islands of remote I/O via the TM5 expansion bus. For Modicon TM7 (IP67) and Modicon TM5 (IP20) modular I/O systems, refer to the essential guide DIA3ED2070413EN or consult [www.schneider-electric.com](http://www.schneider-electric.com)

<sup>(2)</sup> To be ordered separately

2

# Modicon LMC058 Motion Controllers Bases



SoMachine



| Controller type                            |                                   | 42 digital I/O   | 42 digital I/O + 4 analog inputs               |
|--|-----------------------------------|--|--|
| CANmotion Drive synchronisation            | Up to 4 axes                      | 2 ms   |  |
|  | Up to 8 axes                      | 4 ms   |  |
| Internal memory                            | RAM                               | 64 MB  |  |
|  | Flash Eeprom                      | 128 MB   |  |
| Typical Boolean instruction time           |                                   | 22 ns  |  |
| Expert application                         | Relative and Absolute positioning | Yes  |  |
|  | Velocity control                  | Yes  |  |
|  | Homing                            | Yes  |  |
|  | CNC visual editor                 | Yes  |  |
|  | CAM profiles                      | Yes  |  |
|  | Electronic gear                   | Yes  |  |
|  | Interpolation                     | Yes  |  |
|  | Shift Compensation                | Yes  |  |
| Embedded number of digital inputs          |                                   | 26 including 8 high speed counter  |  |
| Embedded number of digital outputs         |                                   | 16 outputs transistor (0.5 A) including 4 reflex outputs   |  |
| Embedded number of analog inputs           |                                   | –  | 4  |
| Optional communication ports               |                                   | –  | 2 PCI slots for optional communication modules |
| Communication                              | USB-B mini-port                   | Programming port for SoMachine software  |  |
|  | USB-A port                        | Connection of a USB memory stick for transferring programs, data files, firmware updates   |  |
|  | RJ45 port (MBS)                   | RS232 serial link<br>RS485 serial link (supplies 250 mA, 5 V for HMI power supply)<br>Protocols: Modbus ASCII/RTU Master/Slave, ASCII (character string) |  |
|  | SUB-D connector (CAN0)            | CANopen bus master (63 slaves)   |  |
|  | SUB-D connector (CAN1)            | CANmotion bus master (63 slaves)   |  |
|  | SUB-D connector (Encoder)         | Encoder input (incremental or SSI)   |  |
|  | RJ45 port (Ethernet)              | Ethernet IP device   |  |
|  |                                   | Ethernet TCP Modbus  |  |
| SoMachine protocol                         |                                   |  |  |
| FTP server embedded<br>Web server embedded |                                   |  |  |
| Max. number of expansions                  |                                   | 250  |  |
| References                                 |                                   | LMC058LF42   | LMC058LF424                                    |

## I/O expansion modules

For I/O expansion modules, please consult Modicon TM5 page 2/23



SoMachine



| Type                      |                              | Characteristics   |                                    |   |
|---------------------------|------------------------------|---|------------------------------------|---|
| Display                   | LCD screen size / Resolution | 3,8" / QVGA   | 5,7" / QVGA                        |   |
|                           | Type                         | STN monochrome, amber or red  | STN monochrome, gray               | STN 4096 colours                            |
| Functions                 | Representation of variables  | Alphanumeric, bitmap, bargraph, gauge, button, light, clock, flashing light, keypad                                       |                                    |   |
|                           | Curves / Alarm logs          | Yes, with log / Yes, incorporated   |                                    |   |
|                           | Control                      | 5 languages IEC   |                                    |   |
| Communication             | Serial link                  | –   | 1 Sub9 (RS 232/RS 422 - RS 485)    |   |
|                           | Networks                     | –   | –                                  | Ethernet, IEEE 802.3<br>10/100 BASE-T, RJ45 |
| Downloadable protocols    |                              | Mitsubishi (Melsec), Omron (Sysmac), Rockwell Automation (Allen Bradley), Siemens (Simatic)<br>Uni-TE, Modbus, Modbus TCP |                                    |   |
| Development software      |                              | SoMachine (on Windows XP and Vista)   |                                    |   |
| Dimensions W x D x H (mm) |                              | 130 x 76 x 104  | 207 x 76 x 157                     |   |
| Compatibility with PLCs   |                              | Twido, Modicon TSX Micro, Modicon Premium, Modicon Quantum, Modicon M340  |                                    |   |
| «Compact Flash» card slot |                              | No  |                                    |   |
| USB port Host type A      |                              | 1   | 1                                  | 1   |
| Built-in Ethernet TCP/IP  |                              | No  | No                                 | Yes   |
| Integrated I/O            |                              | 12I/6O 24 VDC   | 16I/16O 24 VDC                     |   |
| Extensions                |                              | 2 modules TM2<br>or CANopen module  | 3 modules TM2<br>or CANopen module |   |
| Supply voltage            |                              | 24 VDC  |                                    |   |
| References                | Source Output                | XBTGC1100T  | XBTGC2120T                         | XBTGC2230T                                  |
|                           | Sink Output                  | XBTGC1100U  | XBTGC2120U                         | XBTGC2230U                                  |

2

## Extensions

| Type of module  | CANopen Master                                    |
|-----------------|---|
| Characteristics | Class M10 limited 16 slaves, Standard DS301 V4.02 |
| References      | XBTZGCCAN   |

| Type of module  | Digitals Inputs / Outputs      |                                 |                       |                       |                                 |  |   |
|-----------------|--------------------------------|---------------------------------|-----------------------|-----------------------|---------------------------------|--|---|
| Characteristics | 8I<br>24 VDC<br>Screw terminal | 16I<br>24 VDC<br>Screw terminal | 16I<br>24 VDC<br>HE10 | 32I<br>24 VDC<br>HE10 | 8I<br>120 VAC<br>Screw terminal | 4I 24 VDC<br>40 Relays<br>Screw terminal | 16I 24 VDC<br>80 Relays<br>Screw terminal |
| References      | TM2DDI8DT                      | TM2DDI16DT                      | TM2DDI16DK            | TM2DDI32DK            | TM2DAI8DT                       | TM2DMM8DRT                               | TM2DMM24DRF                               |

| Type of module  | Digitals Inputs / Outputs                 |                                  |                                  |   |  |            |
|-----------------|---|----------------------------------|----------------------------------|---|--|------------|
| Characteristics | 8O Transistor<br>24 VDC<br>Screw terminal | 16O Transistor<br>24 VDC<br>HE10 | 32O Transistor<br>24 VDC<br>HE10 | 8O Relays<br>230 VAC 30 VDC<br>Screw terminal | 16O Relays<br>230 VAC 30 VDC<br>Screw terminal | –          |
| References      | Source Output                             | TM2DD08TT                        | TM2DD016TK                       | TM2DD032TK                                    | TM2DRA8RT                                      | TM2DRA16RT |
|                 | Sink Output                               | TM2DD08UT                        | TM2DD016UK                       | TM2DD032UK                                    | –  | –          |

| Type of module  | Analog Inputs / Outputs |                 |                                   |                    |                         |           |
|-----------------|-------------------------|-----------------|-----------------------------------|--------------------|-------------------------|-----------|
| Characteristics | 2I Current/Voltage      | 2I Thermocouple | 4I Current/Voltage<br>Temperature | 8I Current/Voltage | 8I Temperature          | 8I PTC    |
| References      | TM2AMI2HT               | TM2AMI2LT       | TM2AMI4LT                         | TM2AMI8HT          | TM2ARI8LRJ<br>TM2ARI8LT | TM2ARI8HT |

| Type of module  | Analog Inputs / Outputs |            |  |                                      |  |
|-----------------|-------------------------|------------|--|--------------------------------------|--|
| Characteristics | 1O Current/Voltage      | 2O Voltage | 2I Current/Voltage<br>1O Current/Voltage | 2I Temperature<br>1O Current/Voltage | 4I Current/Voltage<br>2O Current/Voltage |
| References      | TM2AMO1HT               | TM2AVO2HT  | TM2AMM3HT                                | TM2ALM3LT                            | TM2AMM6HT                                |

For HMI Controllers **Magelis XBTGT/GK** with control function, refer to the Essential guide DIA1ED2040506EN or consult [www.schneider-electric.com](http://www.schneider-electric.com)



SoMachine

2

| Type of card                                  |                              | Integrated controller card  |
|---|------------------------------|---|
| Variable speed drive compatibility            |                              | Altivar 71 / Altivar 61 (1)   |
| Power supply                                  |                              | 24 VDC  |
| Inputs  | Digital                      | 10 x 24 V DC inputs, 4 of which can be used for<br>2 high-speed counter inputs (100 kHz) or<br>2 incremental encoders (A/B) (100 kHz) |
|   | Analog                       | 2 x 0...20 mA inputs  |
| Outputs                                       | Digital                      | 6 transistor outputs (2 A) - source   |
|   | Analog                       | 2 x 0...20 mA outputs   |
| Built-in communication ports                  | RJ45 port                    | Ethernet Modbus TCP, Web/FTP Server   |
|   | SUB-D connector (male 9-way) | Master CANopen bus (16 slaves)  |
|   | USB Mini-B port              | SoMachine software programming  |
| Real-time clock                               |                              | Integrated  |
| Typical time (for 1000 Boolean instructions)  |                              | 942 µs  |
| Data storage memory FRAM (Ferroelectric RAM)  |                              | 64 KB   |
| Compiled program size (saved in flash memory) |                              | 2 MB  |
| User program size                             |                              | 1 MB  |
| References                                    |                              | VW3A3521  |

(1) Refer to motion & drives essential guide or consult [www.schneider-electric.com](http://www.schneider-electric.com)



| Type of card | I/O expansion cards (2)  |   |
|--------------|--|---|
| Designation  | I/O extension logic  | Extended  |
| Description  | 1 relay logic output ("C/O" contact)<br>4 x 24 VDC positive or negative logic inputs<br>2 x 24 VDC open collector positive or negative logic outputs<br>1 input for PTC probes | 1 x 0...20 mA differential current analog input<br>1 software-configurable voltage (0...10 VDC) or current (0...20 mA) analog input<br>2 software-configurable voltage (±10V, 0...10 VDC) or current (0...20 mA) analog inputs<br>1 relay logic output ("C/O" contact)<br>4 x 24 VDC positive or negative logic inputs<br>2 x 24 VDC open collector positive or negative logic outputs<br>1 input for PTC probes<br>1 frequency control input |
| References   | VW3A3201   | VW3A3202  |

(2) Altivar 71 / 61 variable speed drives can only take one I/O expansion card with the same reference



SoMachine

| Type                                     | OEM machine programming software   |                   |                   |
|--|--|-------------------|-------------------|
| <b>Compatibility</b>                     | Modicon M238 - Logic controller<br>Modicon M258 - Logic controller<br>Modicon LMC058 - Motion controller<br>Magelis XBT GC - HMI controllers<br>XBT GT/GK with control function - HMI controllers<br>Altivar IMC - Drive controller  |                   |                   |
| <b>IEC 61131-3 Programming languages</b> | IL (Instruction List)<br>LD (Ladder Diagram)<br>SFC (Sequential Function Chart)<br>ST (Structured Text)<br>FBD (Function Block Diagram)<br>CFC (Continuous Function Chart)   |                   |                   |
| <b>Languages</b>                         | English<br>French<br>German<br>Italian<br>Spanish<br>Simplified Chinese.   |                   |                   |
| <b>System Requirements</b>               | Processor: Pentium 3 - 1.2 GHz or higher<br>RAM Memory: 2 GByte; recommended: 3 GByte<br>Hard Disk: 3.5 GB, recommended: 4 GB<br>OS: Windows XP Professional, Windows Vista 32 Bit<br>Drive: DVD reader<br>Display: 1024 × 786 pixel resolution or higher<br>Peripherals: a Mouse or compatible pointing device<br>Peripherals: USB interface<br>Web Access: Web registration requires Internet access |                   |                   |
| <b>Licence type</b>                      | Trial (30 days)  | 1 (Single)        | 10 (Team)         |
| <b>References DVD</b>                    | <b>MSDCHNSFN30</b>   | <b>MSDCHNLMUA</b> | <b>MSDCHNLMTA</b> |

2

## Simplify machine programming and commissioning

The SoMachine software solution, developed specifically for OEM machine builders, allows you to design, commission and service your machine in a single environment. It helps you get to market faster and gives your machines a competitive advantage.

A single software suite to create and manage your complete automation solution from control and HMI to remote devices.

### Flexible and Scalable Control platforms include:

- Controllers:
    - > HMI controllers: XBT GC, XBT GT/GK CANopen,
    - > Logic controllers: Modicon M238, Modicon M258,
    - > Motion Controller Modicon LMC 058,
    - > Integrated Controller Card Altivar IMC,
    - > Modicon TM2, TM5 and TM7 I/O offers
  - HMI:
    - > HMI Magelis graphic panels: XBT GT, XBT GK, HMI STO, HMI STU, XBT GH
- SoMachine is a professional, efficient, and open software solution integrating Vijeo-Designer. It integrates also the configuring and commissioning tool for motion control devices. It features all IEC 61131-3 languages, integrated field bus configurators, expert diagnostics and debugging, as well as outstanding capabilities for maintenance and visualisation.

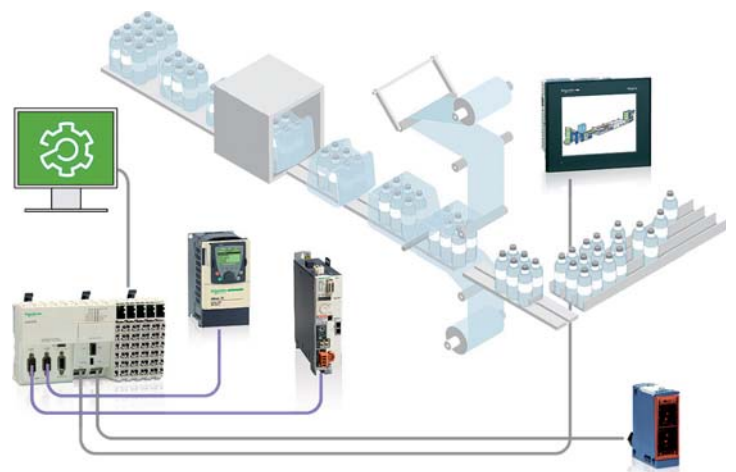

1

|  |  |   |  |
|--|--|---|--|
| <b>Software suite</b><br>for controllers, HMI, and remote devices. | <b>Download</b><br>to transfer the entire machine program in a single step | <b>Connection</b><br>to access to all devices | <b>File</b><br>Create and maintain a single project file |
|--|--|---|--|



| Type of processor                            |                                      |   | Standard  |   | High-performance   |   |  |
|--|--------------------------------------|---|---|---|--|---|--|
| Number of racks                              |                                      |   | 2 (4, 6, 8 or 12 slots)   |   | 4 (4, 6, 8 or 12 slots)  |   |  |
| <b>Maximum configuration</b>                 |                                      |   | Maximum 24 slots for processor and modules (excluding power supply module)  |   | Maximum 48 slots for processor and modules (excluding power supply module) |   |  |
| <b>Functions</b>                             | Max. no. (1)                         | Discrete I/O  | 512   |   | 1024   |   |  |
|  |                                      | Analog I/O  | 128   |   | 256  |   |  |
|  | Control channels                     | Programmable loops (via CONT-CTL process control EFB library) |   |   |  |   |  |
|  | Counter channels                     | 20  |   | 36  |  |   |  |
|  | Motion control                       | –   |   | Independent axes on CANopen bus (via MFB library) | –  | Independent axes on CANopen bus (via MFB library) |  |
|  | Integrated connections               | Ethernet TCP/IP   | –   |   |  |   | 1 RJ45 port, 10/100 Mb/s, with Transparent Ready class B10 standard web server |
|  |                                      | CANopen master bus Integrated port                            | –   |   | 1 (SUB-D9)   | –   | 1 (SUB-D9)   |
|  |                                      | Serial link   | 1 RJ45 port, Modbus master/slave RTU/ASCII or character mode (non isolated RS 232C/RS 485), 0.3...19.2 Kb/s   |   |  |   | –  |
|  |                                      | USB port  | 1 port, 12 Mb/s   |   |  |   |  |
|  | Communication module                 | Ethernet TCP/IP   | 1 RJ45 port, 10/100 Mb/s with:<br>- Transparent Ready class B30 standard web server with BMX NOE 0100 module<br>- Transparent Ready class C30 configuration web server with BMX NOE 0110 module |   |  |   |  |
| <b>Internal user</b>                         | Total capacity                       | 2048 Kb   |   | 4096 Kb   |  |   |  |
| <b>RAM</b>                                   | Program, constants and symbols       | 1792 Kb   |   | 3584 Kb   |  |   |  |
|  | Data                                 | 128 Kb  |   | 256 Kb  |  |   |  |
| <b>Execution time for one instruction</b>    | Boolean                              | 0.18 µs   |   | 0.12 µs   |  |   |  |
|  | On words or fixed point arithmetic   | Single-length words   | 0.38 µs   |   | 0.25 µs  |   |  |
|  |                                      | Double-length words   | 0.26 µs   |   | 0.17 µs  |   |  |
|  | On floating points                   | 1.74 µs   |   | 1.16 µs   |  |   |  |
| <b>No. of K instructions executed per ms</b> | 100% Boolean                         | 5.4 Kinst/ms  |   | 8.1 Kinst/ms                                      |  |   |  |
|  | 65% Boolean and 35% fixed arithmetic | 4.2 Kinst/ms  |   | 6.4 Kinst/ms                                      |  |   |  |
| <b>System overhead</b>                       | Master task                          | 1.05 ms   |   | 0.70 ms   |  |   |  |
|  | Fast task                            | 0.20 ms   |   | 0.13 ms   |  |   |  |
| <b>References</b>                            |                                      |   | <b>BMXP341000</b>   | <b>BMXP342000</b>                                 | <b>BMXP3420102</b>   | <b>BMXP342020</b>   <b>BMXP3420302</b>            |  |

(1) Only affects in-rack modules. The remote I/O on the CANopen bus are not included in these maximum numbers.

## Memory cards



| Type of card         | 8 MB memory card                                    | 8 MB memory card + 8 MB files  | 8 MB memory card + 128 MB files |
|----------------------|---|--|---------------------------------|
| <b>Use</b>           | Supplied as standard with each processor. Used for: | As replacement for the memory card supplied as standard with each processor, used for: |                                 |
|                      | Backup of program, constants, symbols and data      |  |                                 |
|                      | –   | File storage, 8 MB   | File storage, 128 MB            |
|                      | Activation of class B10 web server                  |  |                                 |
| <b>Compatibility</b> | BMXP341000/20...                                    | BMXP3420...  |                                 |
| <b>References</b>    | <b>BMXRMS008MP</b>                                  | <b>BMXRMS008MPF</b>  | <b>BMXRMS0128MFP</b>            |

2



| Type of module               |                                 | Ethernet Network Communication                                |   |                            |
|------------------------------|---------------------------------|---|---|----------------------------|
| <b>Speed</b>                 |                                 | 10/100 Mb/s   |   | 10/100 Mb/s                |
| <b>Protocols</b>             |                                 | Modbus TCP  | TCP/IP (Uni-TE, Modbus)                       | EtherNet/IP and Modbus/TCP |
| <b>Conformity class</b>      |                                 | Transparent Ready class B30                                   |   | -                          |
| <b>Communication service</b> | I/O Scanning service            | Yes   |   | Yes                        |
| <b>Transparent Ready</b>     | FDR service                     | Yes (client/server)   |   | Yes (client / server)      |
|                              | SNMP network management service | Yes   |   | Yes (agent)                |
|                              | Global Data service             | Yes   |   | No                         |
|                              | SOAP/XML Web service            | No  | Server  | -                          |
|                              | Bandwidth management            | Yes   |   | Yes                        |
|                              | Qos                             | -   |   | Yes                        |
|                              | RSTP                            | -   |   | No SOAP                    |
| <b>References</b>            |                                 | <b>BMXNOE0100</b>   | <b>BMXNOE0110</b>                             | <b>BMXNOC0401</b>          |
| <b>Memory card</b>           | Use                             | Provides services conforming to Transparent Ready:<br>Class B |   | No                         |
|                              |                                 |   | Class C<br>32 MB available for user web pages |                            |
| <b>References</b>            |                                 | <b>BMXRWSB000M</b>  | <b>BMXRWSFC032M</b>                           |                            |

Qos: Quality of Service - RSTP: Rapid Spanning Tree Protocol



| Type of module           |  | PROFIBUS DP V1  |                                       |
|--------------------------|--|---|---------------------------------------|
| <b>Designation</b>       |  | PROFIBUS Remote Master (Ethernet Modbus TCP/PROFIBUS DP V1) compatible with all programmable automation under UNITY and supporting the I/O scanning service   |                                       |
|                          |  | Standard version 0...65°  | Hardened version -25...70°, varnished |
| <b>Speed</b>             |  | 9.6 Kb...12 Mb  |                                       |
| <b>Interface</b>         |  | RS485 isolated (Sub-D 9 pin female connector)   |                                       |
| <b>PROFIBUS Services</b> |  | Master Class 1 and 2, support for 125 slaves, Sync & Freeze, Extended diagnostics.<br>Delivered with communication DTM allowing any FDT tool to access the PROFIBUS slaves from the Ethernet network by way of the PROFIBUS Remote Master |                                       |
| <b>References</b>        |  | <b>TCSEGPA23F14F</b>  | <b>TCSEGPA23F14FK</b>                 |

| Type of module              | Serial link (1)   | AS-Interface (1)  |
|-----------------------------|-------------------|-------------------|
| <b>Number of interfaces</b> | 2                 | 1                 |
| <b>Speed</b>                | 115 Kbits/s       | -                 |
| <b>Profile</b>              | -                 | M4 (AS-i V3)      |
| <b>References</b>           | <b>BMXNOM0200</b> | <b>BMXEIA0100</b> |

(1) For BMXNOC0401 (EtherNet/IP), Profibus DP Gateway TSX EGPA23F14F, Modbus Plus Gateway TCS EGDB23F24FA



## Communication modules



| Type of module                                  |  | RTU communication   |
|---|--|---|
| <b>Designation</b>                              |  | Communication   |
| <b>Protocols</b>                                |  | IEC 60870-5-101, DNP3 (subset level 3), Modbus/TCP,<br>IEC 60870-5-104, DNP3 IP, DNP3 (subset level 3),<br>Multi-protocols master slave |
| <b>Ports</b>                                    | Ethernet port  | 10BASE-T/100BASE-TX or PPPoE (PPP Protocol over Ethernet) for ADSL external modem   |
|   | Serial port  | Non-isolated RS 232/485 (Serial link) or RS232 external modem (Radio, PSTN, GSM, GPRS/3G)   |
| <b>Conformity class</b>                         |  | Transparent Ready class C30   |
| <b>Transparent Ready communication services</b> | I/O Scanning service                                     | -   |
|   | Global Data service                                      | -   |
|   | NTP me synchronization                                   | Yes   |
|   | FDR service  | Yes (client)  |
|   | SMTP e-mail notification service                         | Yes   |
|   | SOAP/XML Web service                                     | Server  |
|   | SNMP network management service                          | Yes (agent)   |
| <b>RTU communication services</b>               | Master or Slave configuration                            | Yes, IEC101/104 and DNP3, with Pull through routing of events   |
|   | RTU clock synchronization                                | via RTU protocol or NTP   |
|   | Time stamped data and events exchanges                   | Yes, IEC101/104 and DNP3, polled interrogations, Report by exception (RbE), unsolicited responses                                       |
|   | Time stamped events buffering and date stamped events    | up to 100000 events, backup of events on power fail (10000)   |
|   | Automatic bacfill of time stamped events to Master/SCADA | Yes, on network disconnection/reconnection  |
|   | Data logging service                                     | in CSV files in SD card memory (128 MB)   |
|   | Email/SMS service  | Alarm and report notification   |
| <b>Memory Card</b>                              | SD card 128 MB   | Web server and Data logging CSV files   |
| <b>Reference</b>                                |  | <b>BMXNOR0200H</b>  |

2



| Type of module                            | Power supply modules               |                                      |  |                   |                       |
|---|------------------------------------|--------------------------------------|--|-------------------|-----------------------|
| <b>Voltage</b>                            | 24 VDC isolated                    | 24...48 VDC isolated                 | 100...240 VAC                          |                   |                       |
| <b>Nominal input current</b>              | 1A at 24 VDC                       | 1.65 A at 24 VDC<br>0.83 A at 48 VDC | 0.61 A at 115 VAC<br>0.31 A at 220 VDC | 1.04 A at 0.52 A  | 100...150 VDC         |
| <b>Micro-break duration</b>               | ≤ 1                                |                                      |  |                   |                       |
| <b>Integrated protection</b>              | Via internal fuse (not accessible) |                                      |  |                   |                       |
| <b>Max. useful power</b>                  | 17W                                | 32 W                                 | 20 W                                   | 36 W              |                       |
| <b>Max. dissipated power</b>              | 8.5 W                              |                                      |  |                   |                       |
| <b>Removable connectors</b><br>(set of 2) | supplied as standard               | <b>BMXXTSCPS10</b> (cage clamp)      |  |                   |                       |
|   | to be ordered separately           | <b>BMXXTSCPS20</b> (spring-type)     |  |                   |                       |
| <b>References</b>                         | <b>BMXCPS2010</b>                  | <b>BMXCPS3020</b>                    | <b>BMXCPS2000</b>                      | <b>BMXCPS3500</b> | <b>BMXCPS3504</b> (1) |

## Racks



| Designation                            | Racks  |                   |                   |                   |
|--|--|-------------------|-------------------|-------------------|
| <b>Type of modules to be installed</b> | BMX CPS power supply, BMX P34 processor, I/O modules and application-specific modules (counter, communication) |                   |                   |                   |
| <b>No. of slots</b>                    | 4  | 6                 | 8                 | 12                |
| <b>References</b>                      | <b>BMXXBP0400</b>  | <b>BMXXBP0600</b> | <b>BMXXBP0800</b> | <b>BMXXBP1200</b> |

## Rack extensions

| Designation       | Rack extension module                | Kit for rack extension  |
|-------------------|--------------------------------------|---|
|                   | Standard module to interconnect rack | A complete assembly kit for to racks distant from 0.8 m or less |
| <b>References</b> | <b>BMXXBE1000</b>                    | <b>BMXXBE2005</b>   |



| Type of module              |  |  | DC input modules                                     |                   |                          |                     |  |                            |
|-----------------------------|--|--|--|-------------------|--------------------------|---------------------|--|----------------------------|
| <b>Number of inputs</b>     |  |  | 16   | 16                | 32                       | 64                  | 16   | 16                         |
| <b>Connection</b>           |  |  | Screw or spring-type 20-way removable terminal block |                   | 1 connector 40-way       | 2 connectors 40-way | Screw or spring-type 20-way removable terminal block |                            |
| <b>Nominal input values</b> |  |  | Voltage  |                   | 24 V                     | 48 V                | 24 V   | 125 VDC                    |
|                             |  |  | Current  |                   | 3.5 mA                   | 2.5 mA              | 1 mA   | 3 mA                       |
|                             |  |  | Logic  |                   | Positive ( <i>sink</i> ) |                     |  | Negative ( <i>source</i> ) |
| <b>Input limit values</b>   |  |  | At state 1   |                   | Voltage                  |                     | ≥11 V  | ≥34 V                      |
|                             |  |  |  |                   | Current                  |                     | > 2 mA (for U ≥11 V)                                 | > 2 mA (for U ≥34 V)       |
|                             |  |  | At state 0   |                   | Voltage                  |                     | < 5 V  | < 10 V                     |
|                             |  |  |  |                   | Current                  |                     | ≥1.5 mA  | ≥0.5 mA                    |
| <b>References</b>           |  |  | <b>BMXDDI1602</b>                                    | <b>BMXDDI1603</b> | <b>BMXDDI3202K</b>       | <b>BMXDDI6402K</b>  | <b>BMXDAl1602</b>                                    | <b>BMXDDI1604 (1)</b>      |

2



| Type of module              |  |  | AC input modules                                     |                   |                   |                       |               |               |
|-----------------------------|--|--|--|-------------------|-------------------|-----------------------|---------------|---------------|
| <b>Number of inputs</b>     |  |  | 16   |                   |                   | 8                     |               |               |
| <b>Connection</b>           |  |  | Screw or spring-type 20-way removable terminal block |                   |                   |                       |               |               |
| <b>Nominal input values</b> |  |  | Voltage  |                   | 24 VAC            | 48 AC                 | 100...120 VAC | 200...240 VAC |
|                             |  |  | Current  |                   | 3 mA              |                       |               | 10.4 mA       |
|                             |  |  | Frequency  |                   | 50/60 Hz          |                       |               |               |
| <b>Input limit values</b>   |  |  | At state 1   |                   | Voltage           |                       | ≥15 V         | ≥34 V         |
|                             |  |  |  |                   | Current           |                       | ≥2 mA         | ≥2.5 mA       |
|                             |  |  | At state 0   |                   | Voltage           |                       | ≤5 V          | ≤10 V         |
|                             |  |  |  |                   | Current           |                       | ≤1 mA         | ≤4 mA         |
| <b>References</b>           |  |  | <b>BMXDAl1602</b>                                    | <b>BMXDAl1603</b> | <b>BMXDAl1604</b> | <b>BMXDAl0805 (2)</b> |               |               |



| Type of module                  |  |  | DC solid state output modules                        |                   |  |                          |
|---------------------------------|--|--|--|-------------------|--|--------------------------|
| <b>Number of inputs</b>         |  |  | 16   | 16                | 32   | 64                       |
| <b>Connection</b>               |  |  | Screw or spring-type 20-way removable terminal block |                   | One 40-way connector   | Two 40-way connectors    |
| <b>Nominal output values</b>    |  |  | Voltage  |                   | 24 VDC   |                          |
|                                 |  |  | Current  |                   | 0.5 V  |                          |
|                                 |  |  | Logic  |                   | Positive ( <i>source</i> )   | Negative ( <i>sink</i> ) |
| <b>Output limit values</b>      |  |  | Voltage (ripple included)                            |                   | 19...30 (possible up to 34 V, limited to 1 hour in every 24 hours) |                          |
|                                 |  |  | Current per channel                                  |                   | 0.625 A  |                          |
|                                 |  |  | Current per module                                   |                   | 0.125 A  |                          |
| <b>Maximum dissipated power</b> |  |  | 4  | 2.26              | 3.6  | 6.85                     |
| <b>References</b>               |  |  | <b>BMXDDO1602</b>                                    | <b>BMXDDO1612</b> | <b>BMXDDO3202K</b>   | <b>BMXDDO6402K</b>       |



| Type of module         |         | Triac output modules                                    |
|------------------------|---------|---|
| Number of inputs       |         | 16  |
| Connection             |         | Screw or spring-type 20-way removable terminal block    |
| Operating voltage      | Nominal | 100...240 VAC   |
|                        | Limit   | 85...288 VAC  |
| Currents               | Maximum | 0.6 per channel, 2.4 per common, 4.8 for all 4 commons. |
|                        | Minimum | 25 mA at 100 V a, 25 mA at 240 V a.                     |
| Maximum inrush current |         | ≤ 20/cycle  |
| Reference              |         | <b>BMXDAO1605</b>                                       |



| Type of module         |              | Relay output modules                                 |                               |                       |
|------------------------|--------------|--|-------------------------------|-----------------------|
| Number of inputs       |              | 8  | 16                            | 8                     |
| Connection             |              | Screw or spring-type 20-way removable terminal block |                               |                       |
| Max. operating voltage | DC           | 10...34 VDC  | 24...125 VDC (resistive load) |                       |
|                        | AC           | 10...264 VAC   | 200...264 VAC (Cosφ = 1)      | 100...150 VDC         |
| Response time          | Activation   | < 10 ms  |                               |                       |
|                        | Deactivation | < 8 ms   | < 12 ms                       |                       |
| Dissipated power       |              | 2.7 W max  | 3 W                           |                       |
| References             |              | <b>BMXDRA0805</b>                                    | <b>BMXDRA1605</b>             | <b>BMXDRA0804 (1)</b> |



| Type of module                        |                           | 24 VDC mixed I/O modules   |  |                      |                     |
|---------------------------------------|---------------------------|--|--|----------------------|---------------------|
|                                       |                           | Inputs   | Solid state outputs  | Inputs               | Solid state outputs |
| Number of I/O                         |                           | 8  | 8  | 16                   | 16                  |
| Connection                            |                           | Screw or spring-type 20-way removable terminal block                 |  | One 40-way connector |                     |
| Input limit values                    | At state 1                | Voltage  | ≥11V   | ≥11V                 |                     |
|                                       |                           | Current  | ≥3 mA (for U ≥11)  | ≥2 mA (for U ≥11)    |                     |
|                                       | At state 0                | Voltage  | 5 V  | 5 V                  |                     |
|                                       |                           | Current  | ≤1.5 mA  | ≤1.5 mA              |                     |
| Sensor power supply (ripple included) |                           | 19...30 V (possible up to 30 V, limited to 1 hour in every 24 hours) |  |                      |                     |
| Output limit values                   | Voltage (ripple included) |  | 19...30 (possible up to 30 V, limited to 1 hour in every 24 hours) |                      |                     |
|                                       | Current                   | per channel  | 0.625 A  | 0.125 A              |                     |
|                                       |                           | per module   | 5 A  | 3.2 A                |                     |
| Maximum dissipated power              |                           | 3.7 W  |  | 4 W                  |                     |
| References                            |                           | <b>BMXDDM16022</b>   |  | <b>BMXDDM3202K</b>   |                     |

## Discrete I/O modules



| Type of module                        |            | Mixed input/relay output modules                                     |                                      |
|---------------------------------------|------------|--|--------------------------------------|
|                                       |            | 24 VDC inputs  | 24 VDC or 24...240 VAC relay outputs |
| <b>Number of I/O</b>                  |            | 8  | 8                                    |
| <b>Connection</b>                     |            | Screw or spring-type 20-way removable terminal block                 |                                      |
| <b>Nominal values</b>                 | Inputs     | Voltage  | 24 VDC (positive logic)              |
|                                       |            | Current  | 3.5 mA                               |
|                                       | Outputs    | DC voltage   | 24 VDC                               |
|                                       |            | DC   | 2 (resistive load)                   |
|                                       |            | AC voltage   | 220 VAC, Cosφ = 1                    |
| AC                                    | 2 A        |  |                                      |
| <b>Input limit values</b>             | At state 1 | Voltage  | ≥11V                                 |
|                                       |            | Current  | ≥2 mA (for U ≥ 11 V)                 |
|                                       | At state 0 | Voltage  | 5 V                                  |
|                                       |            | Current  | ≤1.5 mA                              |
| Sensor power supply (ripple included) |            | 19...30 V (possible up to 30 V, limited to 1 hour in every 24 hours) |                                      |
| <b>Maximum dissipated power</b>       |            | 3.1 W  |                                      |
| <b>Reference</b>                      |            | BMXDDM16025  |                                      |

2



## Counter and motion control modules



| Type of module     | Analog input module  |                            |                                |  |                   |
|--------------------|--|----------------------------|--------------------------------|--|-------------------|
| Input type         | Isolated high-level inputs   | Isolated high-level inputs | Non isolated high-level inputs | Isolated inputs, low-level voltage, resistors, temperature probes, thermocouples |                   |
| Number of channels | 4  | 8                          | 8                              | 4  | 8                 |
| Nature of inputs   | ± 10 V, ± 5 V, 0...5 V, 0...10 V, 1...5 V<br>0...20 mA, 4...20 mA, ± 20 mA |                            |                                | ±40 mV, ±80 mV, ±160 mV, ±320 mV,<br>±640 mV, ±1.28 V                            |                   |
| Resolution         | 0.35 mV/0.92 µA  |                            |                                | 15 mV + sign   |                   |
| References         | <b>BMXAMI0410</b>  | <b>BMXAMI0810 (1)</b>      | <b>BMXAMI0800 (1)</b>          | <b>BMXART0414</b>  | <b>BMXART0814</b> |

| Type of module     | Analog output module        |                         |                                 |
|--------------------|-----------------------------|-------------------------|---------------------------------|
| Output type        | Isolated high-level outputs |                         | Non isolated high-level outputs |
| Number of channels | 2                           | 4                       | 8                               |
| Range              | Voltage                     | ± 10 V                  | –                               |
|                    | Current                     | 0...20 mA and 4...20 mA | –                               |
| Resolution         | 15 bits + sign              |                         |                                 |
| References         | <b>BMXAMO0210</b>           | <b>BMXAMO0410 (1)</b>   | <b>BMXAMO0802 (1)</b>           |

| Type of module           | Mixed analog I/O module                                 |                                 |
|--------------------------|---|---------------------------------|
| Channel type             | Non-isolated high-level inputs                          | Non-isolated high-level outputs |
| Number of channels       | 4   | 2                               |
| Ranges                   | ±10 V, 0...5 V, 0...10 V, 1...5 V, 0...20 mA, 4...20 mA | ±10 V, 0...20 mA, 4...20 mA     |
| Maximum conversion value | Voltage   | ± 11.25 V                       |
|                          | Current   | 0...30                          |
| Resolution               | 14 bits, 12 bits, 13 bits, 12 bits                      | 12 bits, 11 bits                |
| Reference                | <b>BMXAMM0600</b>                                       |                                 |

| Type of module          | Counter module  |                                       |               | Motion Control Module                   |
|-------------------------|---|---------------------------------------|---------------|---|
|                         | 32 bits   | 16 bits                               | 32 bits       |   |
| Modularity              | 2 channels  | 8 channels                            | 4 channels    | 4 channels                              |
| No. of sensor inputs    | 6 per channel   | 2 per channel                         | 3 per channel | 4 auxiliary inputs                      |
| No. of actuator outputs | 2 per channel   |                                       |               | 2 auxiliary outputs                     |
| Module cycle time       | 1 ms  | 5 ms                                  |               | –                                       |
| Applications            | Upcounting, downcounting, measurement, frequency meter, frequency generator, axis following | Upcounting, downcounting, measurement |               | Frequency generator, Move, set position |
| References              | <b>BMXEHC0200</b>   | <b>BMXEHC0800</b>                     |               | <b>BMXMSP0200</b>                       |



| Type of module     | SSI encoder interface                                 |
|--------------------|---|
| Number of channels | 3   |
| Encoder support    | 8 to 31 bits, 24V                                     |
| Auxiliary input    | 2   |
| Reflex output      | 3   |
| Baud rate          | 100K to 1MHz  |
| Module cycle time  | 1 ms  |
| Functions          | Capture, compare and event, modulo, reduction, offset |
| Reference          | <b>BMXEAE0300</b>                                     |

### Connection accessories



| Removable terminal blocks | 20-way                       |   |                   | 28-way            |                                      |
|---------------------------|------------------------------|---|-------------------|-------------------|--------------------------------------|
|                           | For use with modules         | BMX AMI 0410 - BMX AM0 0210 - BMX AMM 0600 - BMX EHC 0800 |                   |                   | BMX MSP 200, BMX AMI 0800 / AMI 0810 |
| For use with TOR modules  | All 8 and 16 channel modules |   |                   |                   |                                      |
| Composition               | Cage clamp                   | Screw clamp   | Spring-type       | –                 | –                                    |
| Type of connection        | –                            | –   | –                 | Spring-type       | Screw clamp                          |
| References                | <b>BMXFTB2000</b>            | <b>BMXFTB2010</b>   | <b>BMXFTB2020</b> | <b>BMXFTB2820</b> | <b>BMXFTB2800</b>                    |

Some racks, power supply, communication modules and specific modules, plus all the analog modules are now available in «ruggedized version». The references of these products end by a H.

# Modicon Premium Programmable Automation Controller Processors under Unity Pro software



| Type of processor   |                                | TSX 5710                   | TSX 5720                         | TSX 5730                          |
|---|--------------------------------|----------------------------|----------------------------------|-----------------------------------|
|   |                                | 4 racks max.               | 16 racks max.                    | 16 racks max.                     |
| Number of I/O in racks  | Discrete                       | 512                        | 1024                             | 1024                              |
|   | Analog                         | 24                         | 80                               | 128                               |
| Integrated process control  |                                | No / Yes                   | 30 loops / Yes                   | 45 loops / Yes                    |
| Application-specific channels (counter, position control, weighing) |                                | 8                          | 24                               | 32                                |
| Bus   | AS-Interface cabling system    | 2                          | 4                                | 8                                 |
|   | CANopen machine bus            | 1                          | 1                                | 1                                 |
|   | INTERBUS, Profibus DP fieldbus | –                          | 1                                | 3                                 |
| Networks (Ethernet, Modbus Plus, Fipway)                            |                                | 1                          | 2                                | 3                                 |
| Memory capacity   | Without PCMCIA extension       | 96 Kb data/prog.           | 160/192 Kb data/prog. (1)        | 192/208 Kb data/prog. (1)         |
|   | With PCMCIA extension          | 96 Kb data/224 Kb prog.    | 160/192 Kb data (1)/768 Kb prog. | 192/208 Kb data (1)/1,75 MB prog. |
| Execution time for one instruction without ext. PCMCIA              | Boolean                        | 0.19 µs                    | 0.19 µs                          | 0.12 µs                           |
|   | On word or arithmetic          | 0.25 µs                    | 0.25 µs                          | 0.17 µs                           |
| Reference   | Without integrated port        | <b>TSXP57104M</b> (6)      | <b>TSXP57204M</b> (6)            | <b>TSXP57304M</b> (6)             |
|   | Integrated Ethernet            | <b>TSXP571634M</b> (2) (6) | <b>TSXP572634M</b> (6)           | <b>TSXP573634M</b> (6)            |
|   | Integrated CANopen             | –                          | –                                | –                                 |
|   | Integrated Fipio               | <b>TSXP57154M</b> (6)      | <b>TSXP57254M</b> (6)            | <b>TSXP57354M</b> (6)             |

## Processors under PL7 software



| Type of processor   |                                | TSX 5710                         | TSX 5720                              | TSX 5730                                 |
|---|--------------------------------|----------------------------------|---------------------------------------|--|
|   |                                | 4 racks max.                     | 16 racks max.                         | 16 racks max.                            |
| Number of I/O in racks  | Discrete                       | 512                              | 1024                                  | 1024                                     |
|   | Analog                         | 24                               | 80                                    | 128                                      |
| Integrated process control  |                                | No                               | 30 loops                              | 45 loops                                 |
| Application-specific channels (counter, position control, weighing) |                                | 8                                | 24                                    | 32                                       |
| Bus   | AS-Interface cabling system    | 2                                | 4                                     | 8  |
|   | CANopen machine bus            | 1 (with TSXP57103M)              | 1                                     | 1  |
|   | INTERBUS, Profibus DP fieldbus | –                                | 1                                     | 2  |
| Networks (Ethernet, Modbus Plus, Fipway)                            |                                | 1                                | 1                                     | 3  |
| Memory capacity   | Without PCMCIA extension       | 32 K words data/prog.            | 48 K words data/prog. (4)             | 64/80 K words data/prog. (4)             |
|   | With PCMCIA extension          | 32 K words data/64 K words prog. | 32 K words data (4)/160 K words prog. | 80/96 K words data (4)/384 K words prog. |
| Execution time for one instruction without ext. PCMCIA              | Boolean                        | 0.19 µs                          | 0.19 µs                               | 0.12 µs                                  |
|   | On word or arithmetic          | 0.25 µs                          | 0.25 µs                               | 0.17 µs                                  |
| Reference   | Without integrated port        | <b>TSXP57103M</b> (6)            | <b>TSXP57203M</b> (6)                 | <b>TSXP57303AM</b> (6)                   |
|   | Integrated Ethernet            | –                                | <b>TSXP572623M</b> (6)                | <b>TSXP573623AM</b> (6)                  |
|   | Integrated Fipio               | <b>TSXP57153M</b> (6)            | <b>TSXP57253M</b> (6)                 | <b>TSXP57353AM</b> (6)                   |
|   | Integrated Ethernet and Fipio  | –                                | <b>TSXP572823M</b> (6)                | –  |

(1) The second value corresponds to the integrated memory capacity when the processor is equipped with a Fipio manager integrated link

(2) Processor with double format

(3) PC format card on PCI bus

(4) The second value corresponds to the processor with integrated Fipio bus manager link.

(5) with PL7 V4.4 min.

(6) For coated version add C at the end of the reference: example **TSXP571634M** becomes **TSXP571634MC**



HotStandBy offer



|  | <b>TSX 5740</b><br>16 racks max. | <b>TSX 5750</b><br>16 racks max. | <b>TSX 5760</b><br>16 racks | <b>TSXH5724M</b><br>16 racks | <b>TSXH5744M</b><br>16 racks |
|--|----------------------------------|----------------------------------|-----------------------------|------------------------------|------------------------------|
|  | 2048                             | 2048                             | 2048                        | 512                          | 512                          |
|  | 256                              | 512                              | 512                         | 80                           | 128                          |
|  | 60 loops / Yes                   | 90 loops / Yes                   | 90 loops / Yes              | 30 loops / Yes               | 60 loops / Yes               |
|  | 64                               | 64                               | 64                          | 16 (serial communication)    | 16 (serial communication)    |
|  | 8                                | 8                                | 8                           | 0                            | 0                            |
|  | 1                                | 1                                | 1                           | 0                            | 0                            |
|  | 4                                | 5                                | 5                           | 0                            | 0                            |
|  | 4                                | 4                                | 4                           | 2                            | 4                            |
|  | 320 Kb data/prog.                | 1024 Kb data/prog.               | 2048 Kb data/prog.          | 192 Kb                       | 440 Kb                       |
|  | 440 Kb data/2 MB prog.           | 1024 Kb data/7 MB prog.          | 2048 Kb data/7 MB prog.     | 192 Kb data/768 Kb prog.     | 440 Ko data/2 MB prog.       |
|  | 0.06 µs                          | 0.037 µs                         | 0,037 µs                    | 0,039 µs                     | 0,039 µs                     |
|  | 0.07 µs                          | 0.045 µs                         | 0,045 µs                    | 0,054 µs                     | 0,054 µs                     |
|  | -                                | -                                | -                           | <b>TSXH5724M (6)</b>         | <b>TSXH5744M (6)</b>         |
|  | <b>TSXP574634M (6)</b>           | <b>TSXP575634M (6)</b>           | <b>TSXP576634M (6)</b>      |                              |                              |
|  | -                                | -                                | -                           |                              |                              |
|  | <b>TSXP57454M (6)</b>            | <b>TSXP57554M (6)</b>            | -                           |                              |                              |

2

# Modicon Premium Programmable Automation Controller

## Memory extensions for Unity Pro processors



| Type of PCMCIA card |        | Application                     |   | Additional data    |
|---------------------|--------|---------------------------------|---|--------------------|
| <b>Technology</b>   |        | SRAM                            | Flash EPROM only                          | SRAM               |
| <b>Memory size</b>  | 96 Kb  | –                               | <b>TSXMFPB096K</b> (3)                    | –                  |
|                     | 128 Kb | <b>TSXMRPP128K</b>              | <b>TSXMFP128K</b>                         | –                  |
|                     | 224 Kb | <b>TSXMRPP224K / TSXMCP224K</b> | <b>TSXMFP224K</b>                         | –                  |
|                     | 384 Kb | <b>TSXMRPP384K</b>              | <b>TSXMFP384K</b>                         | –                  |
|                     | 448 Kb | <b>TSXMRPC448K</b> (1)          | –   | –                  |
|                     | 512 Kb | –                               | <b>TSXMCP512K</b> (2) / <b>TSXMFP512K</b> | –                  |
|                     | 768 Kb | <b>TSXMRPC768K</b> (1)          | –   | –                  |
|                     | 1 MB   | <b>TSXMRPC001M</b> (1) (6)      | <b>TSXMFP001M</b>                         | –                  |
|                     | 1.7 MB | <b>TSXMRPC01M7</b>              | –   | –                  |
|                     | 2 MB   | <b>TSXMRPC002M</b> (1)          | <b>TSXMCP002M</b> (2) / <b>TSXMFP002M</b> | –                  |
|                     | 3 MB   | <b>TSXMRPC003M</b> (1) (6)      | –   | –                  |
|                     | 4 MB   | –                               | <b>TSXMFP004M</b>                         | <b>TSXMRPF004M</b> |
|                     | 7 MB   | <b>TSXMRPC007M</b> (1) (6)      | –   | –                  |
|                     | 8 MB   | –                               | –   | <b>TSXMRPF008M</b> |

(1) By configuration, the user can reserve part of the memory space for data storage (recipes, production data) on request.

(2) These cards have an additional SRAM area for storing data (recipes, production data).

(3) Backup cartridge of the program when this one reside entirely in PLC internal memory.

## Memory extensions for PL7 processors



| Type of PCMCIA card    |                         | Application                |                   | Additional data    |
|------------------------|-------------------------|----------------------------|-------------------|--------------------|
| <b>Technology</b>      |                         | SRAM                       | Flash EPROM only  | SRAM               |
| <b>Memory size</b> (4) | 32 K words              | <b>TSXMRPP128K</b>         | <b>TSXMFP128K</b> | –                  |
|                        | 64 K words              | <b>TSXMRPP224K</b>         | <b>TSXMFP224K</b> | –                  |
|                        | 64 K words/128 K words  | <b>TSXMRPP384K</b>         | <b>TSXMCP224K</b> | –                  |
|                        | 96 K words              | –                          | <b>TSXMFP096K</b> | –                  |
|                        | 128 K words             | <b>TSXMRPC448K</b>         | <b>TSXMFP384K</b> | –                  |
|                        | 128 K words/128 K words | <b>TSXMRPC768K</b> (5)     | –                 | –                  |
|                        | 256 K words             | <b>TSXMRPC001M</b> (6)     | –                 | –                  |
|                        | 256 K words/640 K words | <b>TSXMRPC01M7</b> (5)     | –                 | –                  |
|                        | 384 K words/640 K words | <b>TSXMRPC002M</b>         | –                 | –                  |
|                        | 512 K words             | <b>TSXMRPC003M</b> (5) (6) | –                 | –                  |
|                        | 992 K words/640 K words | <b>TSXMRPC007M</b> (6)     | –                 | –                  |
|                        | 2048 K words            | –                          | –                 | <b>TSXMRPF004M</b> |

(4) The 1<sup>st</sup> value corresponds to the size of the application area, the second to the size of the additional data area for storing data (recipes, production data, etc).

(5) These cards have an additional SRAM area for storing application object symbols.

(6) For coated version add C at the end of the reference: example **TSXMRPC001M** becomes **TSXMRPC001MC**

## Power supply modules (1)



| Type of power supply module for | Premium         |                 |                 |                         |                 | Atrium (2) |
|---------------------------------|-----------------|-----------------|-----------------|-------------------------|-----------------|------------|
| Input voltage                   | 24 VDC          |                 | 100...240 VAC   | 100...120/200...240 VAC |                 | 24 VDC     |
| Output voltage                  | 5 VDC/24 VDC    |                 |                 |                         |                 |            |
| Total useful power              | 26 W            | 50 W            | 26 W            | 50 W                    | 77 W            | 26 W       |
| Format                          | Standard        | Double          | Standard        | Double                  | Double          | –          |
| Reference                       | TSXPSY1610M (4) | TSXPSY3610M (4) | TSXPSY2600M (4) | TSXPSY5500M (4)         | TSXPSY8500M (4) | TSXPSI2010 |

(1) Process power supplies see chapter 6 "Power supply"

(2) Only for Atrium slot-PLCs under Unity

2

## Racks



| Type of rack      | Non extendable   |                            | Extendable           |
|-------------------|------------------|----------------------------|----------------------|
| For configuration | Mono-rack        |                            | Multi-rack (16 max.) |
|                   | Dimensions WxDxP |                            |                      |
| Reference         | 4 positions      | 188 x 160 x 151,5 mm (3)   | –                    |
|                   | 6 positions      | 261,6 x 160 x 151,5 mm (3) | TSXRKY6 (4)          |
|                   | 8 positions      | 335,3 x 160 x 151,5 mm (3) | TSXRKY8 (4)          |
|                   | 12 positions     | 482,6 x 160 x 151,5 mm (3) | TSXRKY12 (4)         |
|                   |                  |                            | TSXRKY4EX (4)        |
|                   |                  |                            | TSXRKY6EX (4)        |
|                   |                  |                            | TSXRKY8EX (4)        |
|                   |                  |                            | TSXRKY12EX (4)       |

(3) Height of I/O modules : 151,5 mm with HE 10 or SUB-D connectors, 165 mm with screw terminals

(4) For coated version add C at the end of the reference: example **TSXPSY1610M** becomes **TSXPSY1610MC**

## Connection accessories

| Type      | Bus X daisy chaining cable for extendable racks | Line terminators and accessories                      |
|-----------|---|---|
|           | –   | Set of 2  |
| Reference | –   | TSXTLYEX  |
|           | –   | TSXTVSY100 (2 Bus X Transient voltage suppressor) (5) |
|           | L = 1 m   | TSXCBY010K  |
|           | L = 3 m   | TSXCBY030K  |
|           | L = 5 m   | TSXCBY050K  |
|           | L = 12 m  | TSXCBY120K  |
|           | L = 18 m  | TSXCBY180K  |
|           | L = 28 m  | TSXCBY280KT   |
|           | L = 38 m  | TSXCBY380KT   |
|           | L = 50 m  | TSXCBY500KT   |
|           | L = 72 m  | TSXCBY720KT   |
|           | L = 100 m                                       | TSXCBY1000KT  |

(5) Available 1Q 2010.

# Modicon Premium Programmable Automation Controller

## Discrete I/O modules



| Type of module                     |               | Discrete inputs                 |                    |                                     |                 |                 |
|------------------------------------|---------------|---------------------------------|--------------------|-------------------------------------|-----------------|-----------------|
| <b>Connection</b>                  |               | By screw terminals TSXBLY01 (1) |                    | By HE 10 connector (2) high density |                 |                 |
| <b>Number of isolated channels</b> |               | 8                               | 16                 | 16 (3)                              | 32              | 64              |
| <b>Input voltage</b>               | 24 VDC        | TSXDEY08D2 (5)                  | TSXDEY16D2 (5)     | TSXDEY16FK (5)                      | TSXDEY32D2K (5) | TSXDEY64D2K (5) |
|                                    | 48 VDC        | –                               | TSXDEY16D3 (5)     | –                                   | TSXDEY32D3K (5) | –               |
|                                    | 24 VAC        | –                               | TSXDEY16A2 (4) (5) | –                                   | –               | –               |
|                                    | 48 VAC        | –                               | TSXDEY16A3 (5)     | –                                   | –               | –               |
|                                    | 100...120 VAC | –                               | TSXDEY16A4 (5)     | –                                   | –               | –               |
|                                    | 200...240 VAC | –                               | TSXDEY16A5 (5)     | –                                   | –               | –               |

- (1) Terminal block to be ordered separately
- (2) For use with Modicon ABE7 wiring system
- (3) Module with high-speed isolated inputs (filtering from 0.1 to 7.5 ms) able to activate the event-triggered task
- (4) Module also compatible with 24 VDC negative logic



| Type of module                      |                                   | Discrete outputs                |                |                   |                 |                                 |                |            |                |
|-------------------------------------|-----------------------------------|---------------------------------|----------------|-------------------|-----------------|---------------------------------|----------------|------------|----------------|
|                                     |                                   | Solid state                     |                |                   |                 | Relay                           |                |            | Triac          |
| <b>Connection</b>                   |                                   | By screw terminals TSXBLY01 (1) |                | By HE10 conn. (2) |                 | By screw terminals TSXBLY01 (1) |                |            |                |
| <b>Number of protected channels</b> |                                   | 8                               | 16             | 32                | 64              | 8                               | 16             | 8          | 16             |
| <b>Output voltage/current</b>       | 24 VDC/0.5 A                      | TSXDSY08T2 (5)                  | TSXDSY16T2 (5) | –                 | –               | –                               | –              | –          | –              |
|                                     | 24 VDC/2 A                        | TSXDSY08T2 (5)                  | –              | –                 | –               | –                               | –              | –          | –              |
|                                     | 24 VDC/0.1 A                      | –                               | –              | TSXDSY32T2K (5)   | TSXDSY64T2K (5) | –                               | –              | –          | –              |
|                                     | 48 VDC/1 A                        | TSXDSY08T31 (5)                 | –              | –                 | –               | –                               | –              | –          | –              |
|                                     | 48 VDC/0.25 A                     | –                               | TSXDSY16T3 (5) | –                 | –               | –                               | –              | –          | –              |
|                                     | 24...48 VDC-24...240 VAC/5 A Th.c | –                               | –              | –                 | –               | TSXDSY08R5A (5)                 | –              | –          | –              |
|                                     | 24...120 VAC/5 A Th.c             | –                               | –              | –                 | –               | TSXDSY08R4D (5)                 | –              | –          | –              |
|                                     | 24...120 VAC/1 A                  | –                               | –              | –                 | –               | –                               | –              | –          | TSXDSY16S4 (5) |
|                                     | 48...240 VAC/1 A                  | –                               | –              | –                 | –               | –                               | –              | –          | TSXDSY16S5     |
|                                     | 48...240 VA /2 A                  | –                               | –              | –                 | –               | –                               | –              | TSXDSY08S5 | –              |
|                                     | 24 VDC-24...240 VAC/3A            | –                               | –              | –                 | –               | TSXDSY08R5 (5)                  | TSXDSY16R5 (5) | –          | –              |

- (1) Terminal block to be ordered separately
- (2) For use with Modicon ABE7 wiring system



| Type of module                     |              | Discrete I/O                        |                    |
|------------------------------------|--------------|-------------------------------------|--------------------|
| <b>Connection</b>                  |              | By HE 10 connector (2) high density |                    |
| <b>Number of inputs</b>            |              | 16 high-speed                       |                    |
| <b>Number of protected outputs</b> |              | 12 solid state                      | 12 reflex or timed |
| <b>Output voltage/current</b>      | 24 VDC/0.5 A | TSXDMY28FK (5)                      | TSXDMY28RFK (5)    |

- (2) For use with Modicon ABE7 wiring system
- (5) For coated version add C at the end of the reference: example TSXDEY08D2 becomes TSXDEY08D2C

**Connection accessories:** See [www.schneider-electric.com](http://www.schneider-electric.com)

## Analog I/O modules



| Type of module            |                            | Analog input                 |                      |                       |                      |                          |                         |
|---------------------------|----------------------------|------------------------------|----------------------|-----------------------|----------------------|--------------------------|-------------------------|
|                           |                            | High level with common point |                      |                       | High level isolated  | Low level isolated       |                         |
| <b>Connection</b>         |                            | By 25-way SUB-D connector    |                      |                       |                      |                          |                         |
| <b>Number of channels</b> |                            | 4 high-speed                 | 8                    | 16                    | 8                    | 16                       | By terminal block (1)   |
| <b>Resolution</b>         |                            | 16 bits                      | 12 bits              |                       | 16 bits              | 16 bits                  | 16 bits                 |
| <b>Isolation</b>          | Between channels           | Common point                 | Common point         | Common point          | ± 200 VDC            | ± 100 VDC                | ± 2830 Vrms             |
|                           | Between channels and earth | ~ 1000 Vrms                  | ~ 1000 Vrms          | ~ 1000 Vrms           | ~ 1000 Vrms          | ~ 1000 Vrms              | ~ 1780 Vrms             |
| <b>Reference</b>          | High level input (2)       | <b>TSXAEY420</b> (7)         | <b>TSXAEY800</b> (7) | <b>TSYAEY1600</b> (7) | <b>TSXAEY810</b> (7) | –                        | –                       |
|                           | Multi-range                | –                            | –                    | –                     | –                    | <b>TSXAEY1614</b> (3)(7) | <b>TSXAEY414</b> (4)(7) |

(1) Screw terminals **TSXBLY01** to be ordered separately

(2) ± 10 V, 0...10 V, 0...5 V, 1...5 V, 0...20 mA, 4...20 mA

(3) ± 63 mV thermocouple (B, E, J, K, L, N, R, S, T, U)

(4) ± 10 V, ± 5 V, 0...10 V, 0...5 V, 1...5 V, 0...20 mA, 4...20 mA, -13...+63 mV, 0...400 W, 0...3850 W, thermal probe, thermocouple



| Type of module            |                            | Analog output                   |                           |
|---------------------------|----------------------------|---------------------------------|---------------------------|
|                           |                            | Isolated                        | With common point         |
| <b>Connection</b>         |                            | By screw terminals TSXBLY01 (5) | By 25-way SUB-D connector |
| <b>Number of channels</b> |                            | 4                               | 8                         |
| <b>Resolution</b>         |                            | 11 bits + sign                  | 13 bits + sign            |
| <b>Isolation</b>          | Between channels           | ~ 1500 Vrms                     | Common point              |
|                           | Between channels and earth | ~ 1500 Vrms                     | ~ 1000 Vrms               |
| <b>Reference</b>          | Input signal (6)           | <b>TSXASY410</b> (7)            | <b>TSXASY800</b> (7)      |

(5) Terminal block to be ordered separately

(6) ± 10 V, 0...10 V, 0...20 mA, 4...20 mA.

(7) For coated version add C at the end of the reference: example **TSXAEY420** becomes **TSXAEY420C**



| Type of module     | Counter                                 |                     | Counter/measurement            | Electronic cam                                    |
|--------------------|---|---------------------|--------------------------------|---|
| Type of inputs for | Sensors (2)<br>Incremental encoders (3) |                     | Sensors (2)<br>Encoders (3)(4) | Incremental encoders (3)<br>Absolute encoders (5) |
| Counting           | 40 kHz                                  |                     | 500 kHz/200 kHz (5)            |   |
| Cycle time module  | 5 ms                                    | 10 ms               | 1 ms                           | –   |
| Number of channels | 2                                       | 4                   | 2                              | 128 cams  |
| Number of axes     | –                                       | –                   | –                              | 1   |
| Reference          | <b>TSXCTY2A</b> (1)                     | <b>TSXCTY4A</b> (1) | <b>TSXCTY2C</b> (1)            | <b>TSXCCY1128</b> (1)                             |

(1) For coated version add **C** at the end of the reference: example TSXCTY2A becomes TSXCTY2AC

(2) For 2/3-wire PNP/NPN 24 VDC sensors

(3) For 5 VDC RS422, 10...30 VDC Totem Pole incremental encoders

(4) For SSI serial or parallel output absolute encoders

(5) For RS485 serial or parallel output absolute encoders

## Motion control modules



| Module type             | For translators<br>(amplifier for stepper motor) |                     | For analog control servomotors<br>(for asynchronous and brushless motors) |                     |                        |                     |                     |
|-------------------------|--|---------------------|---|---------------------|------------------------|---------------------|---------------------|
| Control outputs         | RS 422   |                     | +/- 10 V  |                     |                        |                     |                     |
| Compatible with drives  | Lexium 05, Twin Line                             |                     | Lexium 05 / 15 LP, MP and HP, Twin Line, Lexium 32                        |                     |                        |                     |                     |
| Functions               | Linear axes                                      | –                   | Limited   | Limited or infinite | Limited or infinite(6) |                     |                     |
|                         | Slave axes                                       | –                   | With static ratio   | With dynamic ratio  | –                      |                     |                     |
| Frequency for each axis | 187 kHz  |                     | 500 kHz with incremental encoder, 200 kHz with absolute encoder (7)       |                     |                        |                     |                     |
| Number of axes          | 1  | 2                   | 2   | 4                   | 3                      |                     |                     |
| Reference               | <b>TSXCFY11</b> (1)                              | <b>TSXCFY21</b> (1) | <b>TSXCAY21</b> (1)   | <b>TSXCAY41</b> (1) | <b>TSXCAY22</b> (1)    | <b>TSXCAY42</b> (1) | <b>TSXCAY33</b> (1) |

(6) With linear interpolation on 2 or 3 axes

(7) SSI serial or with parallel outputs



| Module type             | Servomotors with SERCOS® digital ring<br>(for brushless motors)           |  |   |
|-------------------------|---|--|---|
| Control outputs         | SERCOS® network ring  |  |   |
| Compatible with ranges  | Lexium 15 LP, MP, HP and Lexium 32 modular drive                          |  |   |
| Functions               | Linear or infinite independent axes, slave axes with cam profile or ratio |  |   |
| Processing              | 4 sets of axes with linear interpolation from 2 to 8 axes                 | 4 sets of axes with linear and circular interpolation from 2 to 3 axes (8) | 4 sets of axes with linear interpolation from 2 to 8 axes |
| Frequency for each axis | 4 MB SERCOS® network ring   |  |   |
| Number of axes          | 8 (9)   | 8 (9)  | 16 (10)   |
| Reference               | <b>TSXCSY84</b>   | <b>TSXCSY85</b>  | <b>TSXCSY164</b>  |

(8) TSXCSY85 module supplied with TJE trajectory editor: linear trajectories with links between segments according to polynomial or circular interpolation and circular trajectories.

(9) 8 real axes, 4 imaginary axes and 4 remote axes

(10) 16 axes (real axes, imaginary and remote axes)

## Weighing modules



| Type of module             | ISP Plus   |  |
|----------------------------|--|--|
|                            | supplied uncalibrated  | supplied calibrated and  offer                       |
| Load cell inputs / outputs | 50 measurements (for 1 to 8 load cells) / 2 discrete and 1 RS 485 for display unit |  |
| Reference                  | Without display unit<br><b>TSXISPY101</b> (1)                                      | <b>Please consult your Schneider-electric agency</b> |
|                            | With display unit TSXXBTN410<br><b>TSXISPY121</b>                                  | <b>Please consult your Schneider-electric agency</b> |

Connection accessories: See [www.schneider-electric.com](http://www.schneider-electric.com)

## Communication modules



| Type of module           |                          | Ethernet network communication      |                             |                       |                       |                          |                      |
|--------------------------|--------------------------|-------------------------------------|-----------------------------|-----------------------|-----------------------|--------------------------|----------------------|
| <b>Speed</b>             |                          | 10 Mb/s                             | 10/100 Mb/s                 |                       |                       |                          |                      |
| <b>Standard services</b> |                          | Ethway, Modbus TCP (Uni-TE, Modbus) | Modbus TCP (Uni-TE, Modbus) |                       |                       | EtherNet/IP & Modbus TCP |                      |
| <b>Transparent Ready</b> | Class                    | C10                                 | B30                         | B30                   | C30                   | D10                      | B30                  |
|                          | Global Data              | –                                   | Yes                         | Yes                   | Yes                   | –                        | –                    |
|                          | I/O Scanning             | –                                   | Yes                         | Yes                   | Yes                   | –                        | Yes                  |
|                          | QoS (3)                  | –                                   | –                           | –                     | –                     | –                        | Yes                  |
|                          | TCP Open                 | Yes                                 | –                           | –                     | Yes                   | –                        | –                    |
| <b>Web server</b>        | Standard services        | Yes                                 | Yes                         | Yes                   | Yes                   | Yes                      | Yes                  |
|                          | FactoryCast services     | Yes                                 | –                           | –                     | Yes                   | –                        | –                    |
|                          | FactoryCast HMI services | –                                   | –                           | –                     | –                     | Yes                      | –                    |
| <b>Reference</b>         |                          | <b>TSXETY110WS</b> (4)              | <b>TSXP57</b> (1)           | <b>TSXETY4103</b> (4) | <b>TSXETY5103</b> (4) | <b>TSXWMM100</b> (4)     | <b>TSXETC101</b> (2) |

(1) References: see pages 3/30 and 3/31, Premium processors with integrated Ethernet TCP/IP port

(2) Seamless integration of Modbus and EtherNet/IP environments. Full integration in Unity (FDT/DTM technology). Available Unity V5

(3) QoS: Quality of Service

**Profibus DPV1** is available for Modicon Premium

Please refer to page 3/23



| Type of module              | AS-Interface cabling system | CANopen machine bus  | Fipio manager fieldbus | INTERBUS fieldbus    | Profibus DP V0 fieldbus |
|-----------------------------|-----------------------------|----------------------|------------------------|----------------------|-------------------------|
| <b>Name and description</b> | In-rack                     | PCMCIA               | Integrated port        | In-rack              | In-rack                 |
| <b>Speed</b>                | 167 Kb/s                    | 20 K...1 Mb/s        | 1 Mb/s                 | 0.5 Mb/s             | 9.6 K...12 Mb/s         |
| <b>Reference</b>            | <b>TSXSAY1000</b> (4)       | <b>TSXCPP110</b> (4) | <b>TSXP57</b> (2)      | <b>TSXIBY100</b> (4) | <b>TSXPBY100</b>        |

(2) References: see pages 3/30 and 3/31, Premium processors with integrated Fipio port



| Type of module              |                | Serial links    |                            |                       |                        |                       |                       |
|-----------------------------|----------------|-----------------|----------------------------|-----------------------|------------------------|-----------------------|-----------------------|
|                             |                | Uni-Telway      |                            |                       | Modbus                 |                       | ASCII                 |
| <b>Name and description</b> |                | Integrated port | In-rack                    | PCMCIA                | In-rack                | PCMCIA                | PCMCIA                |
| <b>Speed</b>                |                | 19.2 Kb/s       | 19.2 Kb/s                  | 1.2...19.2 Kb/s       | 19.2 Kb/s              | 1.2...19.2 Kb/s       | 1.2...19.2 Kb/s       |
| <b>Reference</b>            | With interface | RS 485          | <b>TSXSCY21601</b> (3) (4) | <b>TSXSACP114</b> (4) | <b>TSXSCY11601</b> (4) | <b>TSXSACP114</b> (4) | <b>TSXSACP114</b> (4) |
|                             |                | RS 232D         | –                          | <b>TSXSACP111</b> (4) | –                      | <b>TSXSACP111</b> (4) | <b>TSXSACP111</b> (4) |
|                             |                | 20mA CL         | –                          | <b>TSXSACP112</b> (4) | –                      | <b>TSXSACP112</b> (4) | <b>TSXSACP112</b> (4) |

(3) Also designed for Modbus serial (channel 0).



| Type of module              | Other networks        |                     |                        |
|-----------------------------|-----------------------|---------------------|------------------------|
|                             | Modbus Plus           | Fipway              | Fipio (agent function) |
| <b>Name and description</b> | PCMCIA card           | PCMCIA card         | PCMCIA card            |
| <b>Speed</b>                | 1 Mb/s                | 1 Mb/s              | 1 Mb/s                 |
| <b>Reference</b>            | <b>TSXMFBP100</b> (4) | <b>TSXFPP20</b> (4) | <b>TSXFPP10</b> (4)    |

(4) For coated version add C at the end of the reference: example TSXETY110WS becomes TSXETY110WSC

**Connection accessories:** See [www.schneider-electric.com](http://www.schneider-electric.com)

# Modicon Quantum Programmable Automation Controller Processors under Unity Pro software



2

| Type of processor                |                       | Simple applications   | Simple and medium complexity applications |
|----------------------------------|-----------------------|---|---|
| Max. number of discrete I/O (1)  | Local                 | Unlimited (27 slots max.)   |   |
|                                  | Remote/distributed    | 31744 inputs (RIO)/8000 inputs (DIO) and 31744 outputs (RIO)/8000 outputs (DIO)                                 |   |
| Max. number of analog I/O (1)    | Local                 | Unlimited (27 slots max.)   |   |
|                                  | Remote/distributed    | 1984 inputs (RIO)/500 inputs (DIO) and 1984 outputs (RIO)/500 outputs (DIO)                                     |   |
| Type of application-specific I/O |                       | Counter, motion control, high-speed interrupt inputs, time-stamp, serial link, AS-Interface sensor/actuator bus |   |
| Communication ports (2)          | Integrated Modbus     | 2 RS 232/RS 485   | 2 RS 232                                  |
|                                  | Modbus Plus           | 1 integrated, 2 in local rack   | 1 integrated, 6 in local rack             |
|                                  | Ethernet TCP/IP       | 2 in local rack   | 6 in local rack                           |
|                                  | Fieldbus              | Profibus DP: 2 in local rack  | Profibus DP: 6 in local rack              |
| Memory capacity                  | Internal RAM          | 548 KB  | 1056 KB                                   |
|                                  | With PCMCIA extension | –   | –   |
|                                  | Data storage          | –   | –   |
| Reference                        |                       | <b>140CPU31110 (4)</b>  | <b>140CPU43412U (4)</b>                   |

(1) The maximum values for the number of discrete or analog I/O are not cumulative

(2) The numbers of communication modules are not cumulative, 2 or 6 in local rack, depending on model

(3) Processor compatible with Unity Pro software after updating its firmware (via OS-Loader included in Unity Pro)

(4) For coated version add C at the end of the reference: example **T140CPU31110** becomes **140CPU31110C**

(5) Suitable for safety related application up to SIL2 and SIL3





| Complex applications  |                        |                        | Hot Standby redundant applications |   | Long distance HSBY CPU  |
|---|------------------------|------------------------|------------------------------------|---|---|
| Unlimited (26 slots max.)   |                        |                        | Unlimited (13 slots max.)          | Unlimited (26 slots max.)   | Unlimited (13 slots max.)   |
| 31744 inputs (RIO)/8000 inputs (DIO) and 31744 outputs (RIO)/8000 outputs (DIO)   |                        |                        | 31744 inputs and 31744 outputs     | 31744 inputs (RIO)/8000 inputs (DIO) and 31744 outputs (RIO)/8000 outputs (DIO) | 31744 inputs and 31744 outputs (RIO)/8000 outputs (DIO)                     |
| Unlimited (27 slots max.)   |                        |                        | Unlimited (13 slots max.)          | Unlimited (27 slots max.)   | Unlimited (13 slots max.)   |
| 1984 inputs (RIO)/500 inputs (DIO) and 1984 outputs (RIO)/500 outputs (DIO)   |                        |                        | 1984 inputs and 1984 outputs       | 1984 inputs (RIO)/500 inputs (DIO) and 1984 outputs (RIO)/500 outputs (DIO)     | 1984 inputs (RIO)/500 inputs (DIO) and 1984 outputs (RIO)/500 outputs (DIO) |
| Intrinsically safe I/O, counter, motion control, high-speed interrupt inputs, time-stamp, serial link, AS-Interface sensor/actuator bus |                        |                        | –                                  | –   | –   |
| 1 RS 232/485  |                        |                        | 1 RS 232/485                       | 1 RS 232/485  | 1 RS 232/485  |
| 1 integrated, 6 in local rack   |                        |                        | 1 integrated                       | 1 integrated, 6 in local rack   | 1 integrated, 6 in local rack   |
| 1 integrated, 6 in local rack   |                        |                        | 1 integrated, 6 in local rack      | 6 in local rack   | 1 integrated, 6 in local rack   |
| Profibus DP: 6 in local rack  |                        |                        | –                                  | Profibus DP: 6 in local rack  | –   |
| 768 KB  | 1024 KB                | 3072 KB                | 1024 KB                            | 1024 KB   | 1024 MB   |
| 7 MB  | 7 MB                   | 7 MB                   | 7 MB                               | 7 MB  | 7 MB  |
| 8 MB  | 8 MB                   | 8 MB                   | –                                  | 8 MB  | –   |
| <b>140CPU65150 (4)</b>  | <b>140CPU65160 (4)</b> | <b>140CPU65260 (4)</b> | <b>140CPU65160S (5)</b>            | <b>140CPU67160 (4)</b>  | <b>140CPU67160S (5)</b>   |
|   |                        |                        |                                    |   | <b>140CPU67261</b>  |

2

# Modicon Quantum Programmable Automation Controller

## Power supply modules <sup>(1)</sup>



2

| Type of power supply module for |      |                | Quantum         |                 |                 |                 |                 |
|---------------------------------|------|----------------|-----------------|-----------------|-----------------|-----------------|-----------------|
| Input voltage                   |      |                | 24 VDC          | 48...60 VDC     | 100...150 VDC   | 120...130 VAC   | 115/230 VAC     |
| Output current                  |      |                | 8 A/3 A (5)     | 8 A             | 8 A/3 A         | 8 A/3 A         | 11 A            |
| Reference                       | Type | Standalone (2) | 140CPS21100 (6) | –               | 140CPS51100 (6) | 140CPS11100 (6) | –               |
|                                 |      | Summable       | 140CPS21400 (6) | 140CPS41400 (6) | –               | –               | 140CPS11420 (6) |
|                                 |      | Redundant      | 140CPS22400 (6) | 140CPS42400 (6) | 140CPS52400 (6) | –               | 140CPS12420 (6) |

(1) Process power supplies see chapter 6 "Power supply"

(2) The output current for the standalone power supply modules is 3 A

## PCMCIA memory extensions



| Type of PCMCIA card for Unity processors 140CPU65/67 |                   | Application     |                 | Additional data |
|--|-------------------|-----------------|-----------------|-----------------|
| Technology   |                   | SRAM            | Flash EPROM     | SRAM            |
| Memory size  | 512 Kb/512 Kb (4) | –               | TSXMCPC512K (3) | –               |
|  | 1 MB (5)          | TSXMRPC001M (6) | TSXMFPP001M     | –               |
|  | 2 MB (5)          | TSXMRPC002M     | TSXMFPP002M     | –               |
|  | 2 MB/1 MB (4)     | –               | TSXMCPC002M     | –               |
|  | 3 MB (5)          | TSXMRPC003M (6) | –               | –               |
|  | 4 MB              | –               | TSXMFPP004M     | TSXMRPF004M     |
|  | 7 MB (5)          | TSXMRPC007M (6) | –               | –               |
|  | 8 MB              | –               | –               | TSXMRPF008M     |

(3) These cards have an additional SRAM area for storing data (recipes, production data).

(4) The 1<sup>st</sup> value corresponds to the size of the application area, the second to the size of the additional data area for storing data (recipes, production data, etc)

(5) By configuration the user can reserve part of the memory space for data storage (recipes, production data, etc)

(6) For coated version add C at the end of the reference: example **TSXMRPC001M** becomes **TSXMRPC001MC**

## Racks

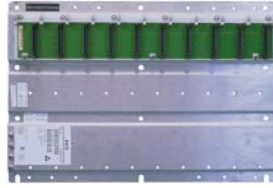

| Type       |                       | Racks          |                     |
|------------|-----------------------|----------------|---------------------|
|            | Dimensions WxDxH      |                |                     |
| References | 2 slots               | 104x104x290 mm | 140XBP00200 (2)     |
|            | 3 slots               | 143x104x290 mm | 140XBP00300 (2)     |
|            | 4 slots               | 184x104x290 mm | 140XBP00400 (2)     |
|            | 6 slots               | 265x104x290 mm | 140XBP00600 (2)     |
|            | 10 slots              | 428x104x290 mm | 140XBP01000 (2)     |
|            | 16 slots              | 671x104x290 mm | 140XBP01600 (2)     |
|            | Rack extension module |                | 140XBE10000 (1) (2) |

(1) Local extension module, to be placed in main rack and secondary rack.

(2) For coated version add C at the end of the reference: example **140XBP00200** becomes **140XBP00200C**

## Connection accessories <sup>(3)</sup>

| Type       | Cable for extension racks (main and secondary) |             |
|------------|--|-------------|
| References | L = 1 m  | 140XCA71703 |
|            | L = 2 m  | 140XCA71706 |
|            | L = 3 m  | 140XCA71709 |

(3) **Other accessories:** See [www.schneider-electric.com](http://www.schneider-electric.com)

# Modicon Quantum Programmable Automation Controller

## Discrete I/O modules



2

| Type of module (5)                 |                            | Discrete inputs   |                          |                    |                    |                    |                    |
|------------------------------------|----------------------------|---|--------------------------|--------------------|--------------------|--------------------|--------------------|
| <b>Connection</b>                  |                            | By screw terminals 140XTS00200 (to be ordered separately) |                          |                    |                    |                    |                    |
| <b>Number of isolated channels</b> |                            | 16  | 4 groups of 8            | 3 groups of 8      | 2 groups of 8      | 6 groups of 16     | 8 groups of 2      |
| <b>Input voltage</b>               | 5 VDC TTL (negative logic) | –   | <b>140DDI15310</b>       | –                  | –                  | –                  | –                  |
|                                    | 24 VDC                     | –   | <b>140DDI35300(1)(2)</b> | –                  | –                  | <b>140DDI36400</b> | –                  |
|                                    | 10...60 VDC                | –   | <b>140DDI85300</b>       | –                  | –                  | –                  | <b>140DDI84100</b> |
|                                    | 20...30 VDC                | –   | <b>140DSI35300(1)</b>    | –                  | –                  | –                  | –                  |
|                                    | 125 VDC                    | –   | –                        | <b>140DDI67300</b> | –                  | –                  | –                  |
|                                    | 24 VAC                     | <b>140DAI34000</b>  | <b>140DAI35300</b>       | –                  | –                  | –                  | –                  |
|                                    | 48 VAC                     | <b>140DAI44000</b>  | <b>140DAI45300</b>       | –                  | –                  | –                  | –                  |
|                                    | 115 VAC                    | <b>140DAI54000</b>  | <b>140DAI55300</b>       | –                  | <b>140DAI54300</b> | –                  | –                  |
| 230 VAC                            | <b>140DAI74000</b>         | <b>140DAI75300</b>  | –                        | –                  | –                  | –                  |                    |

(1) For negative logic, replace 00 at the end of the reference with 10, for example **140DDI35300** becomes **140DDI35310**.

(2) Non-interfering module in safety related application



| Type of module (5)                  |                       | Discrete outputs  |  |                    |                    |                    |                    |
|-------------------------------------|-----------------------|---|--|--------------------|--------------------|--------------------|--------------------|
|                                     |                       | Solid state   |  |                    |                    |                    |                    |
| <b>Connection</b>                   |                       | By screw terminals 140XTS00200 (to be ordered separately) |  |                    |                    |                    |                    |
| <b>Number of protected channels</b> |                       | 16  | 4 groups of 8                                  | 4 groups of 4      | 2 groups of 8      | 6 groups of 16     | 2 groups of 6      |
| <b>Output voltage/current</b>       | 5 VDC TTL/0.075 A (3) | –   | <b>140DDO15310</b>                             | –                  | –                  | –                  | –                  |
|                                     | 24 VDC/0.5 A          | –   | <b>140DDO35301(1)</b><br><b>140DDO35300(2)</b> | –                  | –                  | –                  | –                  |
|                                     | 10...30 VDC/0.5 A (4) | –   | <b>140DVO85300</b>                             | –                  | –                  | –                  | –                  |
|                                     | 19.2...30 VDC/0.5 A   | –   | –  | –                  | –                  | <b>140DDO36400</b> | –                  |
|                                     | 10...60 VDC/2 A       | –   | –  | –                  | <b>140DDO84300</b> | –                  | –                  |
|                                     | 24...125 VDC/0.75 A   | –   | –  | –                  | –                  | –                  | <b>140DDO88500</b> |
|                                     | 24...48 VAC/4 A       | –   | –  | <b>140DAO84220</b> | –                  | –                  | –                  |
|                                     | 24...115 VAC/4 A      | <b>140DAO84010</b>  | –  | –                  | –                  | –                  | –                  |
|                                     | 24...230 VAC/ 4-3 A   | <b>140DAO84000</b>  | <b>140DAO85300</b>                             | –                  | –                  | –                  | –                  |
|                                     | 100...230 VAC/4-3 A   | –   | –  | <b>140DAO84210</b> | –                  | –                  | –                  |

(1) For negative logic, replace 01 at the end of the reference with 10, for example **140DDO35301** becomes **140DDO35310**.

(2) Non-interfering module in safety related application

(3) Negative logic

(4) Controlled outputs



| Type of module (5)            |  | Discrete I/O  |                    |                             | Discrete outputs   |                    |
|-------------------------------|--|---|--------------------|-----------------------------|--------------------|--------------------|
|                               |  | Solid state   |                    |                             | Relay              |                    |
| <b>Connection</b>             |  | By screw terminals 140XTS00200 (to be ordered separately) |                    |                             |                    |                    |
| <b>Number of I/O</b>          |  | 2 groups of 8/2 groups of 4                               |                    | 1 group of 4/<br>4 isolated | –/16 NO            | –/8 NO/NC          |
| <b>Input voltage</b>          |  | 24 VDC  | 115 VAC            | 125 VDC                     | –                  | –                  |
| <b>Output voltage/current</b> |  | 24 VDC / 4 A  | 115 VAC / 8 A      | 24...125 VDC / 16 A         | 2 A                | 5 A                |
| <b>Reference</b>              |  | <b>140DDM39000</b>  | <b>140DAM59000</b> | <b>140DDM69000</b>          | <b>140DRA84000</b> | <b>140DRC83000</b> |

(5) For coated version add C at the end of the reference: example **140DDI15310** becomes **140DDI15310 C**

Connection accessories: See [www.schneider-electric.com](http://www.schneider-electric.com)

## Analog I/O modules



| Type of module (4) | Analog inputs   |                           |                    |                         |                     |
|--------------------|---|---------------------------|--------------------|-------------------------|---------------------|
| Connection         | By screw terminals 140XTS00200 (to be ordered separately) |                           |                    |                         |                     |
| Number of channels | 8   | 16                        | 8                  |                         |                     |
| Input signal       | 4...20 mA<br>1...5 V                                      | 0...25/20 mA<br>4...20 mA | (1)                | Thermal probe<br>Pt, Ni | Thermocouple<br>(2) |
| Resolution         | 12 bits   | 0...25000 points          | 16 bits            | 12 bits + sign          | 16 bits             |
| Reference          | <b>140ACI03000</b>  | <b>140ACI04000</b> (3)    | <b>140AVI03000</b> | <b>140ARI03010</b>      | <b>140ATI03000</b>  |

(1) 0...25 mA,  $\pm 20$  mA, 4...20 mA, 0...10 V,  $\pm 10$  V, 0...5 V,  $\pm 5$  V, 1...5 V.

(2) Type B, E, J, K, R, S, T, mV

(3) Non-interfering module in safety related application



| Type of module (4) | Analog output   |                           |  |
|--------------------|---|---------------------------|--|
| Connection         | By screw terminals 140XTS00200 (to be ordered separately) |                           |  |
| Number of channels | 4   | 8                         | 4  |
| Input signal       | 4...20 mA   | 0...25/20 mA<br>4...20 mA | 0...10 V, $\pm 10$ V<br>0...5 V, $\pm 5$ V |
| Resolution         | 12 bits   | 0...25000 points          | 12 bits                                    |
| Reference          | <b>140ACO02000</b> (3)                                    | <b>140ACO13000</b>        | <b>140AVO02000</b>                         |

(3) Non-interfering module in safety related application



| Type of module (4) | Analog I/O  |
|--------------------|---|
| Connection         | By screw terminals 140XTS00200 (to be ordered separately)                             |
| Number of inputs   | 4   |
| Number of outputs  | 2   |
| Input signal       | 0...20 mA, $\pm 20$ mA, 4...20 mA, 0...10 V, $\pm 10$ V, 0...5 V, $\pm 5$ V, 1...5 V. |
| Resolution         | Inputs 16 bits, outputs 12 bits   |
| Reference          | <b>140AMM09000</b>  |

(4) For coated version add C at the end of the reference: example 140ACI03000 becomes 140ACI03000C

Connection accessories: See [www.schneider-electric.com](http://www.schneider-electric.com)

# Modicon Quantum Programmable Automation Controller

## Counter and special purpose modules



| Type of module     | High-speed counter   |                    | High-speed inputs with interrupt | Time-stamp system      |
|--------------------|----------------------|--------------------|----------------------------------|------------------------|
| Type of inputs for | Incremental encoders |                    | Discrete 24 VDC (2)              | Discrete 24...125 VDC  |
| Counting frequency | 100 kHz              | 500 kHz            | –                                | –                      |
| Number of channels | 5                    | 2                  | 16                               | 32                     |
| Reference          | <b>140EHC10500</b>   | <b>140EHC20200</b> | <b>140HLI34000</b>               | <b>140ERT85410 (4)</b> |

(2) 3 operating modes: Interrupt, latch, high-speed inputs, on rising or falling edge.

## Safety I/O modules



| Type of modules   | Analog  | Discrete            |                     |
|-------------------|---|---------------------|---------------------|
| Connection        | Screw terminal  |                     |                     |
| Number of inputs  | 8 analog inputs   | 16 discrete inputs  | –                   |
| Number of outputs | –   | –                   | 16 discrete outputs |
| Input signal      | 4...20mA  | 24VDC               | –                   |
| Output voltage    | –   | –                   | 24VDC               |
| Resolution        | 16 bits   | –                   | –                   |
| Certification     | Suitable for safety related application up to SIL2 and SIL3, UL, CE, CSA, Haz-loc |                     |                     |
| Reference         | <b>140SAI94000S</b>   | <b>140SDI95300S</b> | <b>140SDO95300S</b> |

## Communication modules



| Type of module           |                      | Ethernet TCP/IP network |             |             |             |                          |
|--------------------------|----------------------|-------------------------|-------------|-------------|-------------|--------------------------|
| Speed                    |                      | 10/100 Mb/s             |             |             |             |                          |
| Protocol                 |                      | Modbus TCP              | Modbus TCP  | Modbus TCP  | Modbus TCP  | EtherNet/IP & Modbus TCP |
| Transparent Ready        | Class                | B30                     | B30         | C30         | D10         | B30                      |
|                          | Global Data          | Yes                     | Yes         | Yes         | –           | –                        |
|                          | I/O Scanning         | Yes                     | Yes         | Yes         | –           | Yes                      |
|                          | FDR server           | Yes                     | Yes         | Yes         | –           | Yes                      |
|                          | SNMP protocol        | Yes                     | Yes         | Yes         | Yes         | Yes                      |
| Web server               | QoS (1)              | –                       | –           | –           | –           | Yes                      |
|                          | Standard services    | Yes                     | Yes         | Yes         | Yes         | –                        |
|                          | FactoryCast services | –                       | –           | Yes         | Yes         | –                        |
| FactoryCast HMI services |                      | –                       | –           | –           | Yes         | –                        |
| Reference                |                      | 140CPU651* (2)          | 140NOE77101 | 140NOE77111 | 140NWM10000 | 140NOC77101              |

(1) QoS: Quality of Service

(2) 140 CPU 651 50, 140 CPU 651 60, 140 CPU 652 60, 140 CPU 671 60

PROFIBUS DPV1 is available for Modicon Quantum

Please refer to page 3/23



| Type of module       | Modbus Plus network | AS-Interface cabling system | Fieldbus INTERBUS | Profibus DP Master V1 (1) | Modnet fielbus |
|----------------------|---------------------|-----------------------------|-------------------|---------------------------|----------------|
| Name and description | Integrated link     | In-rack                     | In-rack           | In-rack                   | In-rack        |
| Speed                | 1 Mb/s              | 167 Kb/s                    | 0,5 Mb/s          | to 12 Mb/s                | 375 Kb/s       |
| Reference            | 140CPU*             | 140EIA92100                 | 140NOA62200       | PTQPDPMV1                 | 140NOG11100    |

(1) from your partner Prosoft, [www.prosoft-technology.com](http://www.prosoft-technology.com)

\* 140 CPU 311 10, 140 CPU 434 12U, 140 CPU 651 50, 140 CPU 651 60, 140 CPU 652 60, 140 CPU 671 60



| Type of module       | Serial link     |             |
|----------------------|-----------------|-------------|
|                      | Modbus          | ASCII       |
| Name and description | Integrated link | In-rack     |
| Speed                | 19.2 Kb/s       | 19.2 Kb/s   |
| Reference            | 140CPU* (1)     | 140ESI06210 |

(1) RS 232/RS 485 on 140CPU651●● and 140CPU67160 processors and RS 232 on 140CPU31110, 140CPU43412A, 140CPU53414A processors.

\* 140 CPU 311 10, 140 CPU 434 12U, 140 CPU 651 50, 140 CPU 651 60, 140 CPU 652 60, 140 CPU 671 60

To operate in a corrosive environment, Quantum modules can be ordered with a conformal coating applied to components of the product. Conformal coating will extend its life and enhance its environmental performance capabilities. To order conformal coating append a C to the standard catalog number. For example, 140CPS 11420 > 140CPS 114 20C

# Automation systems Unity Pro, configuration software For Modicon M340, Premium, and Quantum

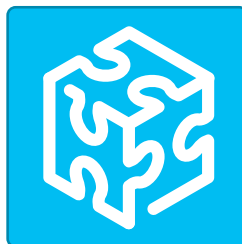

2

| Software type            |                             | Unity Pro Small version 6.0       |                        |                        |                             |
|--------------------------|-----------------------------|-----------------------------------|------------------------|------------------------|-----------------------------|
| License type version 6.0 |                             | Single (1 workstation)            | Group (3 workstations) | Team (10 workstations) | Facility (100 workstations) |
| References               | Software pack               | UNYSPUSFUCD60                     | UNYSPUSFGCD60          | UNYSPUSFTCD60          | –                           |
|                          | Upgrade Legacy Software (1) | UNYSPUSZUCD60                     | UNYSPUSZGCD60          | UNYSPUSZTCD60          | –                           |
| Software type            |                             | Unity Pro Medium version 6.0      |                        |                        |                             |
| License type version 6.0 |                             | Single (1 workstation)            | Group (3 workstations) | Team (10 workstations) | Facility (100 workstations) |
| References               | Software pack               | UNYSPUMFUCD60                     | UNYSPUMFGCD60          | UNYSPUMFTCD60          | –                           |
|                          | Upgrade Legacy Software (2) | UNYSPUMZUCD60                     | UNYSPUMZGCD60          | UNYSPUMZTCD60          | –                           |
| Software type            |                             | Unity Pro Large version 6.0       |                        |                        |                             |
| License type version 6.0 |                             | Single (1 workstation)            | Group (3 workstations) | Team (10 workstations) | Facility (100 workstations) |
| References               | Software pack               | UNYSPULFUCD60                     | UNYSPULFGCD60          | UNYSPULFTCD60          | UNYSPULFFCD60               |
|                          | Upgrade Legacy Software (3) | UNYSPULZUCD60                     | UNYSPULZGCD60          | UNYSPULZTCD60          | UNYSPULZFC60                |
| Software type            |                             | Unity Pro Extra Large version 6.0 |                        |                        |                             |
| License type version 6.0 |                             | Single (1 workstation)            | Group (3 workstations) | Team (10 workstations) | Facility (100 workstations) |
| References               | Software pack               | UNYSPUEFUCD60                     | UNYSPUEFGCD60          | UNYSPUEFTCD60          | UNYSPUEFFCD60               |
|                          | Upgrade Legacy Software (4) | UNYSPUEZUCD60                     | UNYSPUEZGCD60          | UNYSPUEZTCD60          | UNYSPUEZFC60                |

(1) From Concept S, PL7 Micro, ProWORX NxT Lite and ProWORX 32 Lite

(2) From Concept S/M, PL7 M/J, ProWORX NxT Lite and ProWORX 32 Lite

(3) From Concept S /M, PL7 M/J/P, ProWORX NxT Lite and ProWORX 32 Lite

(4) From all models Concept, PL7, ProWORX NxT and ProWORX 32

Unity Pro, is common programming software for debugging and operation of Modicon M340, Premium, and Quantum programmable controller ranges. Unity Pro takes the recognized usage values of PL7 and Concept software and offers a complete set of new functions for improved productivity and opening to other software.

Five IEC61131-3 languages are supported as standard in Unity Pro with all debugging functions, either on the simulator or directly online with the programmable controller.

Additional LL984 language is now available in Unity V 6.0 (Unity V6.0 available 2Q 2011) to allow easy migration of Modsoft an Concept applications to Quantum platforms.

Thanks to symbolic variables independent of memory, structured data and user function blocks, application objects are a direct reflection of the automated process application components. Unity Pro operator screens are user-configured in the application from graphic libraries. Operator accesses are simple and direct. The converters integrated in Unity Pro automatically convert PL7 and Concept IEC 61131-3 standards and applications.

Unity V 6.0 fully support new Quantum Ethernet RIO architectures.

It integrates additional possibilities for Online changes in RUN mode, as well as improved Search/Replace Toll.

Debugging and Maintenance, as well as Design are greatly simplified and improved.



# Unity software

## Specialized software

2

### Unity Pro application comparison software

| Software type             |                        | Unity Dif  |
|---------------------------|------------------------|--|
| Licence type version 2.21 |                        | Single (1 workstation), French and English languages (software and documentation)          |
| Reference                 | Software extension (1) | UNYSDUZFUCD22  |
| Licence type version 2.21 |                        | Site licence (100 workstations), French and English languages (software and documentation) |
| Reference                 | Software extension (1) | UNYSDUZFFCD22  |

(1) Requires version Unity V2.1 or later

### EF/EFB function development software in C language

| Software type            |               | Unity EFB Toolkit   |
|--------------------------|---------------|---|
| Licence type version 3.1 |               | Single (1 workstation), English language (software and documentation) |
| References               | Software pack | UNYSPUZFUCD31E  |
|                          | Renewal       | UNYCSPSPUZBU  |

### Process application design and generation software

| Software type            |               | Unity UAG (Unity Application Generator) |                          |
|--------------------------|---------------|---|--------------------------|
| Licence type version 3.2 |               | Single (1 workstation)                  | Site (> 10 workstations) |
| References               | Software pack | UAGSEWLFUCD32                           | UAGSEWLFFCD23            |

### Specific libraries according to the software used

| Library type | Control Libraries                                      |                                       |                               |                              |  |
|--------------|--|---------------------------------------|-------------------------------|------------------------------|--|
| Designation  | Predictive Control Library (for Unity Pro and Concept) | Fuzzy Control Library (for Unity Pro) | TeSys Library (for Unity Pro) | HVAC Library (for Unity Pro) | Flow Calculation Library (for Unity Pro) |
| Licence type | Single Licence (1 work station)                        |                                       |                               |                              |  |
| Reference    | UNYLPZAUWB10   | UNYLFZZAUWB12                         | UNYLTZSAUWB10                 | UNYLHVZAUWB10                | UNYLAGZAUWB20                            |

| Library type | UAG Libraries                        |                                       |
|--------------|--------------------------------------|---------------------------------------|
| Designation  | Device and Process Library (for UAG) | Process Application Library (for UAG) |
| Licence type | Single Licence (1 workstation)       |                                       |
| Reference    | UAGSBTDFUWB13                        | UAGSBTXFUWB20                         |

\*Includes Process Application Library (PAL) V2.0 and Device and Process Library (DPL) V1.0

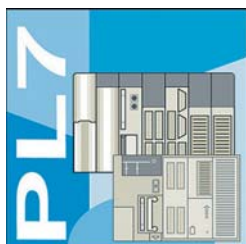

PL7 is the common programming, debugging and operating software for the TSX Micro and Premium ranges of PLCs as well as Atrium coprocessors (see pages 3/12, 3/18 and 3/26).

PL7 offers 4 IEC languages: Instruction List (IL), Ladder Diagram (LD), Structured Text (ST) and Sequential Function Chart (SFC). You can use the most suitable language for each function in your application, making use of the multi-tasking structure of the processors.

For using application-specific functions, PL7 directly integrates the application-specific screens required for configuration and adjustment as well as supervisory and diagnostics activities.

| Type of software            |                  | PL7 Micro for TSX Micro platform                                  |                        |                         |                         |
|-----------------------------|------------------|---|------------------------|-------------------------|-------------------------|
| Type of license version 4.5 |                  | Single (1 station)  | Single with SyCon V2.8 | Group (3 stations)      | Open Team (10 stations) |
| Reference                   | Software package | TLXCDPL7MP45  | TLXCDPL7MPC45          | TLXCD3PL7MP45           | TLXOTPL7MP45M           |
|                             | Update (1)       | TLXRCDPL7MP45M  | TLXRCDPL7MPC45M        | TLXRCD3PL7MP45M         | –                       |
| Type of license version 4.5 |                  | PL7 Junior for TSX Micro/Premium and Atrium coprocessor platforms |                        |                         |                         |
| Type of license version 4.5 |                  | Single (1 station)  | Group (3 stations)     |                         |                         |
| Reference                   | Software package | TLXCDPL7JP45  | TLXCD3PL7JP45          |                         |                         |
|                             | Update (1)       | TLXRCDPL7JP45M  | TLXRC3DPL7JP45M        |                         |                         |
|                             | Upgrade (2)      | TLXUCDPL7JP45M  | TLXUCD3PL7JP45M        |                         |                         |
| Type of license version 4.5 |                  | PL7 Pro for TSX Micro/Premium and Atrium coprocessor platforms    |                        |                         |                         |
| Type of license version 4.5 |                  | Single (1 station)  | Group (3 stations)     | Open Team (10 stations) | Open Site               |
| Reference                   | Software package | TLXCDPL7PP45  | TLXCD3PL7PP45          | TLXOTPL7PP45M           | TLXOSPL7PP45M           |
|                             | Update (1)       | TLXRCDPL7PP45M  | TLXRCD3PL7PP45M        | –                       | –                       |
|                             | Upgrade (2)      | TLXUCDPL7PP45M  | TLXUCD3PL7PP45M        | –                       | –                       |

(1) From the previous software version.

(2) From lower level, earlier version software.

## Specialist tools

EF function development software in C language

| Type of software            |  | PL7 SDKC for EF function development software in C language |
|-----------------------------|--|---|
| PL7 SDKC software extension |  | For PL7 Micro/Junior/Pro                                    |
| Reference                   |  | TLXLSDKCPL741M  |

Development of applications in C language

| Type of software           |  | PL7 FUZ for processing process applications using fuzzy logic |
|----------------------------|--|---|
| PL7 FUZ software extension |  | For PL7 Micro/Junior/Pro, TSX Micro/Premium                   |
| Reference                  |  | TLXLPL7FUZ34M   |

Comparison of PL7 applications

| Type of software           |  | PL7 DIF for comparison of applications |                      |
|----------------------------|--|--|----------------------|
| PL7 DIF software extension |  | For PL7 Pro, TSX Micro/Premium         |                      |
| Type of license            |  | Single (1 station)                     | Site (> 10 stations) |
| Reference                  |  | TLXCDPL7DIF42                          | TLXOSPL7DIF42        |

Availability of control systems based on Premium platforms

| Type of software                |  | Warm Standby redundant |
|---------------------------------|--|------------------------|
| Warm Standby software extension |  | For PL7 Junior/Pro     |
| Type of license                 |  | Single (1 station)     |
| Reference                       |  | TLXCDWSBYP40F / E      |

# Programming software

## For Modicon Quantum, Momentum



**Concept** is the IEC programming software for the Momentum and Quantum range of PLCs. It provides advanced Microsoft Windows based tools that deliver a multi-language development environment for control system programming.

Uses familiar, standardized editors, bundled in a single application to create and integrate PLC control, communication and diagnostic logic.

Five IEC editors give users the freedom to choose the programming language that fits their application requirements: Function Block Diagram (FBD), Ladder Diagram (LD), Sequential Function Chart (SFC), Structured Text (ST) and Instruction List (IL).

| Type of software                   |                | Concept for Quantum/Momentum platforms |                    |                        |                |
|------------------------------------|----------------|--|--------------------|------------------------|----------------|
| <b>Type of license version 2.6</b> |                | Single (1 station)                     | Group (3 stations) | 10 users (10 stations) | Site           |
| <b>Software references</b>         | Concept S      | 372SPU47101V26                         | –                  | –                      | –              |
|                                    | Concept M      | 372SPU47201V26                         | –                  | –                      | –              |
|                                    | Concept XL     | 372SPU47401V26                         | 372SPU47411V26     | 372SPU47421V26         | 372SPU47431V26 |
| <b>Update references</b>           | Concept S (3)  | 372ESS47101                            | –                  | –                      | –              |
|                                    | Concept M (3)  | 372ESS47201                            | –                  | –                      | –              |
|                                    | Concept XL (3) | 372ESS47401                            | 372ESS47403        | 372ESS47410            | 372ESS47400    |

(3) From an earlier software version.

2

## Specialist tools

EF/EFB function development software in C language

| Type of software       |                  | Concept EFB Toolkit |                     |
|------------------------|------------------|---------------------|---------------------|
| <b>Type of license</b> |                  | Version 2.6         | Upgrade version 2.6 |
| <b>Reference</b>       | Software package | 332SPU47001V26      | 372ESS47001         |

Concept service version limited to application loading

| Type of software       |                  | Concept Application Loader |  |
|------------------------|------------------|----------------------------|--|
| <b>Type of license</b> |                  | Version 2.6                |  |
| <b>Reference</b>       | Software package | 372SPU47701V26             |  |

Software for designing and generating batch/process applications

| Type of software                   |                         | Unity UAG (Unity Application Generator) |               |
|------------------------------------|-------------------------|---|---------------|
| <b>Type of license version 3.0</b> |                         | Single (1 station)                      | Site          |
| <b>Reference</b>                   | Medium Software package | UAGSEWMFUCD31                           | UAGSEWMFFCD31 |
|                                    | Large Software package  | UAGSEWLFUCD31                           | UAGSEWLFCD31  |



## ProWORX for Modicon Quantum, Momentum

**ProWORX 32** is the flexible, easy-to-use cross-platform LL984-programming software for Modicon range PLCs. It gives you the power to program your Modicon controllers online or offline, manage your I/O subsystems, and analyze your plant's activity in real-time, all in a familiar Windows environment.

ProWORX 32 provides client/server capabilities to organize user-groups and -rights, store projects at a central location and realize office-plant floor bridging.

The project emulator provides the ability to test projects prior to running them in the PLC run-time environment to ensure your system will run at peak efficiency.

| Type of software                            |                              | ProWORX for Quantum/Momentum platforms |                    |                          |                 |
|---|------------------------------|--|--------------------|--------------------------|-----------------|
| <b>Type of license version 2.1</b>          |                              | Single (1 station)                     | Group (3 stations) | Multi-user (10 stations) | Site            |
| <b>Software references</b>                  | ProWORX 32 Server            | 372SPU78001PSEV                        | –                  | –                        | –               |
|   | ProWORX 32 Suite             | 372SPU78001PSSV                        | –                  | –                        | –               |
|   | ProWORX 32 Client, Full Dev. | 372SPU78001PDEV                        | 372SPU78001PSTH    | 372SPU78001PSTE          | 372SPU78001SITE |
|   | ProWORX 32 Online            | 372SPU78101PONL                        | –                  | –                        | –               |
|   | ProWORX 32 Lite              | 372SPU71001PLDV                        | 372SPU71001PLTH    | 372SPU71001PLTE          | –               |
| <b>Upgrade to ProWORX 32 references (4)</b> |                              | 372SPU78401LPUP                        | 372SPU78401LPSTH   | 372SPU78401LPSTE         | –               |

(4) Only possible for customers, who are "up-to-date" with CSP (continuing support program)



## Vijeo Citect

|                         |   |
|-------------------------|---|
| <b>Type</b>             | <b>Supervisory control and data acquisition (SCADA) software</b>  |
| <b>Compatibility</b>    | All Schneider Electric automation platforms and third party devices   |
| <b>Operating system</b> | Windows XP® SP3 (32 bit), Windows® 2003 Server SP2 (32 bit), Windows Vista® SP2 (32 and 64 bit), Windows® Server 2008 SP2 (32 and 64 bit), Windows® 7 (32 and 64 bit), Windows® Server 2008 R2  |
| <b>Versions</b>         | The development licence (without network connectivity) allows free communication with PLCs for 10 minutes at a time.<br>Vijeo Citect full server licences are available in 75 points, 150 points, 500 points, 1500 points, 5000 points, 15000 points and unlimited points<br>Vijeo Citect Lite (without network connectivity) is available in 100 - 1200 points |
| <b>References</b>       | Please contact your local sales representative  |

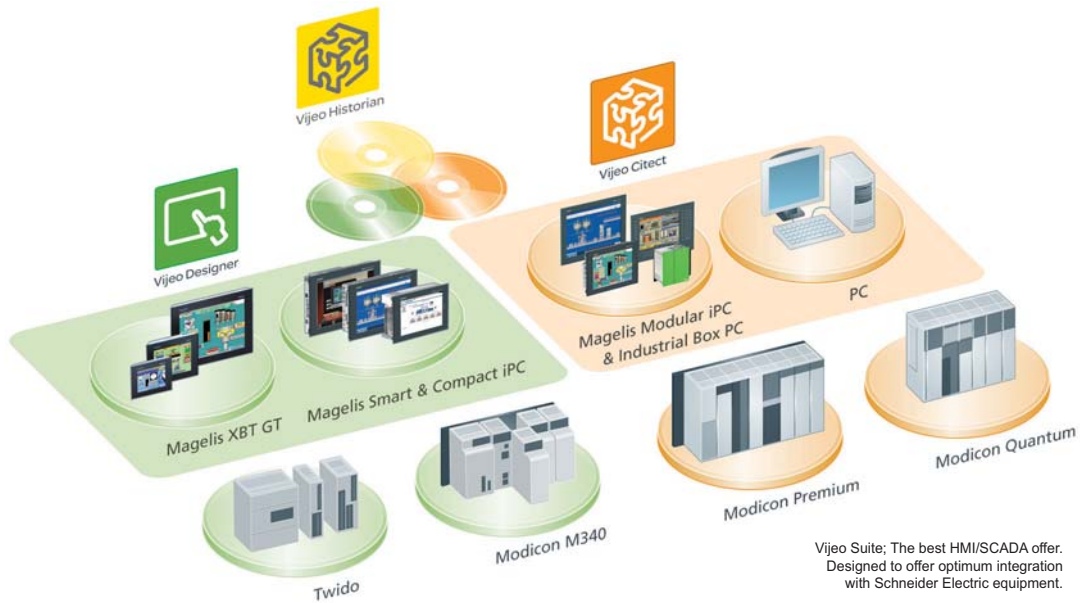

Vijeo Citect is a software for operating and monitoring. With its powerful visualisation capabilities and operational features, it delivers actionable insight faster, enabling operators to respond quickly to process disturbances, thereby increasing their effectiveness. Its easy-to-use configuration tools and powerful features enable you to quickly develop and deploy solutions for any size application.

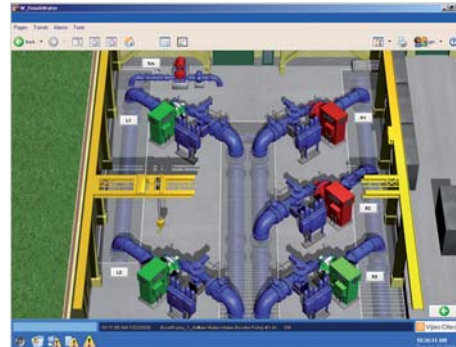

### Benefits at a glance:

- **Full-redundancy for reliable architecture:** Vijeo Citect's in-built redundancy greatly reduces lost data and downtime, tolerating failure anywhere in your system.
- **Powerful graphics:** Vijeo Citect lets you develop true colour, easy-to-use graphics that provide the operator with an intuitive, consistent user interface.
- **Intuitive Process Analysis tool:** Vijeo Citect Process Analyst is an intuitive process analysis tool that sits directly in the SCADA system, providing a complete story of your plant and delivering actionable insight to the operators faster, thereby improving their efficiency and productivity.
- **Object-based configuration for rapid development:** Developing your control system is made quick and easy by Vijeo Citect's object-based configuration tools such as page templates, Genies, Super Genies, and SpeedLink.
- **Engineering with ease:** Vijeo Citect offers flexible and targeted system engineering tools to help you be more efficient. It accelerates your control system configuration process, significantly reducing your engineering time and costs and minimising your project risk.

# Vijeo Historian Reporting software



## Vijeo Historian

|                      |  |
|----------------------|--|
| Type                 | Historian software   |
| Compatibility        | All Schneider Electric automation platforms and third party devices  |
| Operating system     | Windows XP® SP3 (32 bit), Windows® 2003 Server SP2 (32 bit), Windows Vista® SP2 (32 and 64 bit), Windows® Server 2008 SP2 (32 and 64 bit), Windows® 7 (32 and 64 bit), Windows® Server 2008 R2 |
| References CD-ROM PC | Please contact your local sales representative   |

2

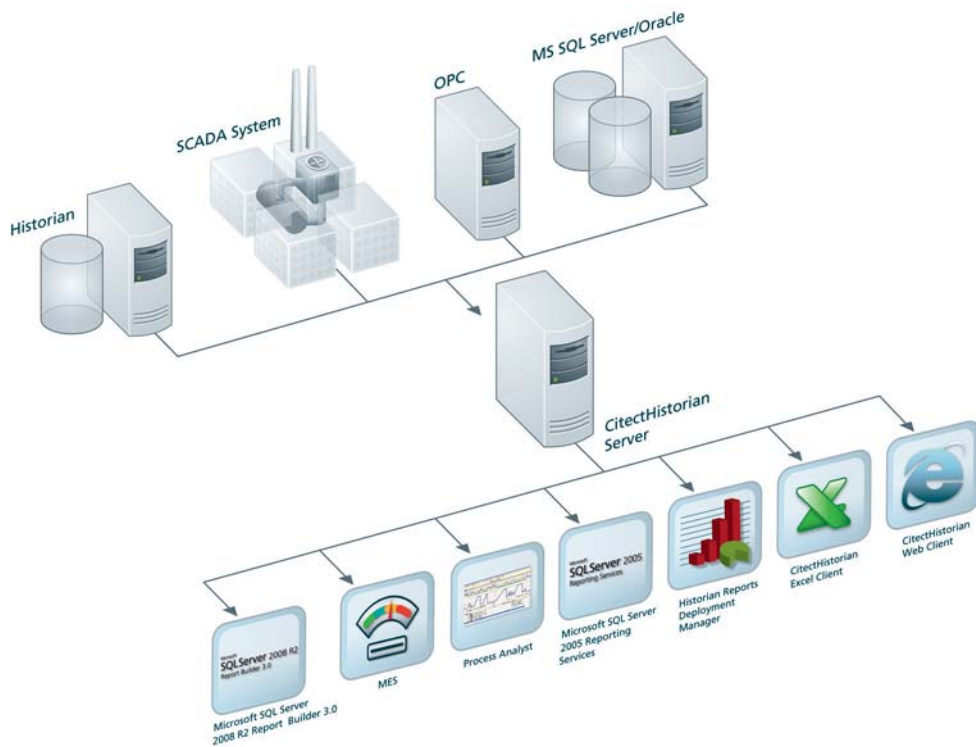

Vijeo Historian is a software for the information management. It comprises the historian and portal functionalities of the solution, enabling you to accurately store data for long-term reporting while connecting your production and business systems through its active data transfers and simple, easy-to-use reporting.

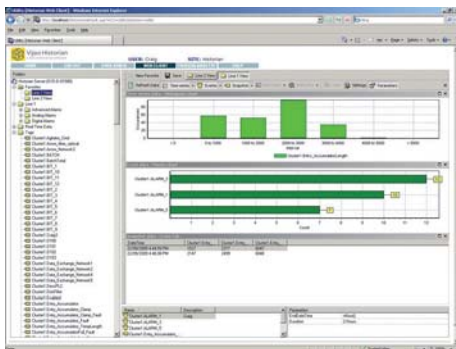

### Benefits at a glance:

- **Business systems integration:** Vijeo Historian reduces the complexity and cost of bridging the divide between senior management and plant operations through its simple, easy-to-use interface and its active data transfers that push data from the control systems up to the business systems.
- **An open data store:** Vijeo Historian utilises 100% Microsoft SQL Server 2008 R2 as its embedded historical data store. Its open, industry-standard technology and trusted security integrate effortlessly into your business in a way that lowers your total cost of ownership.
- **Enterprise-wide reporting:** A range of reports can be produced using a convenient built-in historian in the familiar, open Microsoft user interface. Vijeo Historian also comes with a standard set of pre-configured reports, simplifying basic alarm and tag reporting.
- **Alarm management:** Pre-configured alarm reports based on the EEMUA (Engineering Equipment & Materials Users Association) 191 alarm management guidelines.
- **Going 'green' with the energy reports:** Energy reports help you perform a comprehensive energy assessment of your plant to determine how much energy is being consumed and how much could potentially be saved.

# Altistart and Altivar

Use Altistart soft starters to start your motors smoothly and protect the mechanics of your equipment. With the Altivar range of variable speed drives, you save energy and manage the speed of your motors to optimise and enhance productivity in your installations.



# 3

The Altistart, Altivar and Lexium ranges increase the efficiency of your machines, reduce their energy consumption and optimise their kinematics. Easy to install, offering intuitive programming and extensive communication options, they are easily integrated into your control system architectures.



## Lexium

Controllers, drives, motors and linear positioning axes: Schneider Electric offers a complete range of motion control products and solutions suitable for even the most specialised applications. Designed with maximum simplicity in mind throughout a machine's entire service life, the Lexium range reduces costs and optimises productivity.

# 3 | Motion control



## Soft starters and variable speed drives

|   |              |
|---|--------------|
| <b>Selection guide</b> .....  | 3/3 to 3/7   |
| <b>Starters</b>   |              |
| Altistart 01 .....  | 3/8 to 3/9   |
| Altistart 22 .....  | 3/10 to 3/11 |
| Altistart 48 .....  | 3/12 to 3/13 |
| <b>Drives</b>   |              |
| Altivar 12 .....  | 3/14         |
| Altivar 212 .....   | 3/15         |
| Altivar 312 .....   | 3/16         |
| Altivar 31C .....   | 3/17         |
| Altivar 32 .....  | 3/18         |
| Altivar 61, 61Q, 61 Plus, 61 Plus-LH .....                              | 3/20 to 3/27 |
| Specific cards and extension for pumping and ventilation machines ..... | 3/28 to 3/29 |
| Altivar 71, 71Q, 71 Plus .....  | 3/30 to 3/36 |
| Altivar LIFT .....  | 3/37         |
| Specific cards and extension for complex and high power machines .....  | 3/38 to 3/39 |
| <b>Accessories and options (Altistart et Altivar)</b> .....             | 3/40 to 3/41 |

## Controllers, drives, motors and linear motion axes

|   |              |
|---|--------------|
| <b>Selection Guide</b> .....                                      | 3/42 to 3/43 |
| <b>Servo drives, servo motors Lexium 32 and accessories</b> ..... | 3/44 to 3/51 |
| Lexium 32 servo drives  |              |
| Lexium BMH and Lexium BSH servo motors                            |              |
| <b>Stepper Drives and Stepper Motors Lexium SD</b> .....          | 3/52         |
| Lexium SD2/Lexium SD3 stepper drives                              |              |
| Lexium BRS2/Lexium BRS3 stepper motors                            |              |
| <b>Integrated Drives Lexium IL</b> .....                          | 3/53 to 3/55 |
| Lexium ILA/ILE/ILS/ILT/ILP  |              |
| <b>Single axes and multi-axis Systems Linear Motion</b> .....     | 3/56 to 3/57 |
| Lexium PAS/CAS/TAS/MAX  |              |

# Highlights

## Altivar 32

### More than 150 application-specific functions

The Altivar 32 range of variable speed drives controls asynchronous and synchronous motors rated from 0.18 to 15 kW operating in open loop mode in complex machines:

- Compact, vertical and slim format (45 mm)
- Integrated function blocks for creating simple control system functions (timers, counters, comparators, etc.)
- Machine safety functions integrated as standard (STO, SLS, SS1)
- Open design: communicates with most industrial networks

*For more information, see page 4/18*



## Lexium 32 Inspired by Simplicity

The Lexium 32 servo drive range (0.15 to 7 kW) is a drive system designed for applications where high precision and dynamic positioning are critical:

- Suitable for packaging, materials processing (cutting, turning, milling, etc.) and handling, printing and textile applications
- 3 servo drive families and two types of servo motor available
- Simplified engineering: motor sizing, CAD and cabinet drawings, support for PLCopen libraries and SoMove setup software
- Integrated "Safe Torque Off" function
- Quick integration: wide selection of fieldbus modules

*For more information, see page 4/44*



## Ultra slim and ultra powerful

Practical and innovative, the Altivar 32 and Lexium 32 ranges can help reduce the size of your enclosures by as much as 40%.

- Extra slim book format
- Easy to configure and setup with SoMove software
- Packed with common software tools, accessories and functions
- Homogeneous mounting and wiring systems
- High-performance communication system
- Built-in Bluetooth as standard
- Can be configured with the power off in its original packaging: configurations can be transferred remotely via mobile phone using SoMove Mobile software





# Soft starters and variable speed drives

## Selection guide

### Starters - Low voltage

| Simple machines   | Complex machines/<br>Special machines  |
|---|--|
| <p>⇒Applications:</p> <p>Compressors, fans, pumps, conveyors, car wash gantries, etc.</p> | <p>⇒Applications:</p> <p>Pumps, fans, turbines, compressors, conveyors, conveyor belts, lifting screws, escalators, etc.</p> |

| Altistart 01   | Altistart 22  | Altistart 48   |
|--|---|--|
|  <p>Soft start and Soft start/soft stop units</p> |  <p>Soft start/soft stop units</p> |  <p>Soft start/soft stop units</p> |

|                                     |                                   |   |   |  |
|-------------------------------------|-----------------------------------|---|---|--|
| <b>Description</b>                  |                                   | <ul style="list-style-type: none"> <li>• <b>Compact</b></li> <li>• <b>Simple:</b> easy mounting, wiring and adjustment</li> <li>• <b>Efficient:</b> Current peaks limitation on starting, reduction of mechanical shocks, increased service life for your machines</li> <li>• <b>Energy saving</b></li> </ul> | <ul style="list-style-type: none"> <li>• <b>Innovative</b> with its integrated <b>Bypass</b> contactor for motors up to 315 kW</li> <li>• <b>Cost-effective</b></li> <li>• <b>Compact dimensions</b></li> <li>• <b>Quick setup</b></li> <li>• <b>Protection of motor and starter</b></li> <li>• <b>Energy saving</b></li> <li>• <b>3 controlled phases</b></li> </ul> | <ul style="list-style-type: none"> <li>• <b>Torque control system:</b> controlled torque, prevention of pressure surges and limiting of temperature rises</li> <li>• <b>Simple:</b> quick setup</li> <li>• <b>Protection of motor and starter:</b> thermal protection, phase loss detection, locked rotor detection</li> <li>• <b>Energy saving</b></li> </ul> |
| <b>Technical information</b>        | Power range for 50...60 Hz supply | 0.37...15 kW  | 4... 400 kW   | 4...900 kW   |
|                                     | Voltage                           | Single-phase 110...480 V<br>Three-phase 110...480 V   | Three-phase 208...600 V<br>Three-phase 230...440 V  | Three-phase 208...690 V  |
|                                     | Drive/Output frequency            | –   | –   | –  |
|                                     | Motor type                        | Asynchronous<br>Synchronous   | Yes<br>No   | Yes<br>No  |
| <b>Communication</b>                | Integrated                        | –   | Modbus  | Modbus   |
|                                     | As an option                      | Can be used with TeSys U motor starter-controller to create a complete motor starter solution   | –   | DeviceNet, Fipio, PROFIBUS DP, Ethernet  |
| <b>Standards and certifications</b> |                                   | IEC/EN 60947-4-2, C-Tick, CSA, UL, CE   | IEC/EN 60947-4-2, C-Tick, CSA, UL, CE, GOST, CCC, ABS, Class A EMC  | IEC/EN 60947-4-2, C-Tick, CSA, UL, CE, DNV, GOST, CCC, NOM, SEPRO and TCF, Classes A and B EMC   |
| <b>Intended use</b>                 |                                   | Buildings, Simple machines.   | Machines, Infrastructures and Buildings   |  |

# Selection guide

## Standard drives - Low voltage

### Simple machines

#### ⇒ Applications:

- Simple machines for industry (small handling applications, packaging, pumps, fans, etc.)
- Simple consumer machines (access barriers, rotating advertising hoardings, medical beds, treadmills, dough mixers, etc.)
- Other types of application:
  - Mobile machines and small appliances equipped with a power socket
  - Applications which traditionally use other solutions (2-speed DC motors, mechanical drives, etc.).

#### ⇒ Applications:

Simple industrial machines (material handling and packaging, textile machines, special machines, pumps and fans).

#### ⇒ Applications:

Simple industrial machines (material handling and packaging, textile machines, special machines, pumps and fans).

#### Altivar 12



Variable speed drives for small machines with 240 V three-phase asynchronous motor

#### Altivar 312



Variable speed drives for three-phase asynchronous motors

#### Altivar 31C IP55



Variable speed drives for three-phase asynchronous motors for machines in harsh environments.

#### Description

- **Compact**
- **Easy to set up** (Plug & Play)
- **Reliable, cost-effective solution** for compact machines

- **Open:** large number of communication cards available as options
- **User-friendly:** simplified interface
- **Autotuning:** maximum performance

- **Rugged** even in the most hostile environments:
  - Installed as close as possible to the motor
  - Integrated functions for applications requiring IP55 degree of protection
  - Modbus and CANopen communication protocols
- **Flexibility** to adapt to each machine:
  - Customisable depending on the model
  - Easy configuration

#### Technical information

Power range for 50...60 Hz supply

0.18...4 kW

0.18...15 kW

0.18...15 kW

Voltage

Single-phase 100...240 V  
Three-phase 200...240 V

Single-phase 200...240 V  
Three-phase 200...600 V

Single-phase 200...240 V  
Three-phase 380...500 V

Drive/Output frequency

0.5...400 Hz

0.5...500 Hz

0.5...500 Hz

Motor type

Asynchronous  
Synchronous

Yes

Yes

Yes

No

No

No

#### Communication

Integrated  
As an option

Modbus

Modbus and CANopen

Modbus and CANopen

–

CANopen Daisy chain,  
DeviceNet, PROFIBUS DP,  
Modbus TCP, Fipio

DeviceNet, Ethernet TCP/IP,  
Fipio, PROFIBUS DP





#### Standards and certifications

IEC/EN 61800-5-1, IEC/EN 61800-3 (environments 1 and 2, categories C1 to C3)  
CE, UL, CSA, C-Tick, GOST, NOM

IEC/EN 61800-5-1, IEC/EN 61800-3 (environments 1 and 2, categories C1 to C3)  
CE, UL, CSA, C-Tick, GOST

#### Intended use

Machines

| Complex machines  | Complex machines/<br>Special machines  |  | Pumps and<br>Fans  |   |
|---|--|--|--|---|
| <p>⇒ <b>Applications:</b><br/>Industrial machines: hoisting, packaging, material handling, special machines (wood-working machines, metal processing machinery, etc.).</p>  | <p>⇒ <b>Applications:</b><br/>High performance applications:</p> <ul style="list-style-type: none"> <li>• Material handling</li> <li>• Hoisting</li> <li>• Wood-working machines</li> <li>• Process machinery</li> <li>• Textile machines</li> <li>• Packaging</li> </ul>  | <p>⇒ <b>Applications:</b><br/>High performance applications:</p> <ul style="list-style-type: none"> <li>• Material handling</li> <li>• Hoisting</li> <li>• Wood-working machines</li> <li>• Process machinery</li> <li>• Textile machines</li> <li>• Packaging</li> </ul>  | <p>⇒ <b>Applications:</b><br/>Range specifically for high performance pumps and fans for the industrial and building markets.</p>  | <p>⇒ <b>Applications:</b><br/>Pumping and ventilation machines in harsh environment</p>   |
| <p><b>Altivar 32</b></p>  <p>Variable speed drives for asynchronous motors and open-loop synchronous motors</p>  | <p><b>Altivar 71</b></p>  <p>For three-phase synchronous and asynchronous motors. Constant torque applications.</p>  | <p><b>Altivar 71Q</b></p>  <p>Water-cooled variable speed drives for three-phase synchronous and asynchronous motors. Constant torque applications.</p>  | <p><b>Altivar 61</b></p>  <p>Variable speed drives for three-phase asynchronous motors. Variable torque applications.</p>               | <p><b>Altivar 61Q</b></p>  <p>Water-cooled variable speed drives for three-phase asynchronous and synchronous motors. Variable torque applications</p>  |
| <ul style="list-style-type: none"> <li>• <b>Compact: "Book" format</b></li> <li>• <b>Integrated Safety function</b> compliant to IEC 61508 SIL3 and PL-e</li> <li>• <b>Open:</b> communication cards available as options</li> <li>• <b>Integrated programmable logic functions</b></li> <li>• <b>Simple setup</b></li> <li>• <b>Energy saving : Control of energy efficient permanent magnet synchronous motors</b></li> </ul> | <ul style="list-style-type: none"> <li>• <b>Wide range</b></li> <li>• <b>Quick start-up</b> and easy diagnostics: multi-language graphic display terminal</li> <li>• <b>Open</b> to most industrial communication buses</li> <li>• <b>Integrated safety</b></li> <li>• <b>Motor control:</b> high-performance in open-loop and closed loop mode</li> </ul> | <ul style="list-style-type: none"> <li>• <b>Improved robustness</b> with water cooling</li> <li>• <b>Efficient cooling system reduced need of air conditioning</b></li> <li>• Long time operation <b>without maintenance</b></li> <li>• Excellent protection against corrosion due to <b>stainless steel cooling pipes</b></li> <li>• <b>Very high starting torque</b> for frequent start-up applications</li> </ul> | <ul style="list-style-type: none"> <li>• <b>Wide range</b></li> <li>• <b>Easy setup and diagnostics</b> with the multi-language graphic display terminal</li> <li>• <b>Open</b> to the main communication buses</li> </ul> | <ul style="list-style-type: none"> <li>• <b>Improved robustness</b> with water cooling</li> <li>• <b>Efficient cooling system reduced need of air conditioning</b></li> <li>• Prolonged <b>maintenance-free</b> operational life</li> <li>• Excellent protection against corrosion due to <b>stainless steel cooling pipes</b></li> </ul> |
| 0.18...15 kW  | 0.37...630 kW  | 90...630 kW  | 0.37...800 kW  | 110...800 kW  |
| Single-phase 200...240 V<br>Three-phase 380...480 V   | Single-phase 200...240 V<br>Three-phase 200...690 V  | Three-phase 380...480 V<br>Three-phase 500...690 V   | Single-phase 200...240 V<br>Three-phase 200...690 V  | Three-phase 380...480 V<br>Three-phase 500...690 V  |
| 0.1...599 Hz  | 0...599 Hz up to 37 kW /<br>200...240V and 380...480V<br>0...500 Hz for the rest of the range  | 0...500 Hz   | 0.1...599 Hz up to 37 kW /<br>200...240V and 380...480V<br>0.1...500 Hz for the rest of the range  | 0.1...500 Hz  |
| Yes   | Yes  | Yes  | Yes  | Yes   |
| Yes   | Yes  | Yes  | Yes  | Yes   |
| Modbus and CANopen  | Modbus and CANopen   | Modbus et CANopen  | Modbus and CANopen   | Modbus et CANopen   |
| EtherNet/IP, Modbus TCP, PROFIBUS DP V1, EtherCAT, Devicenet  | Modbus TCP, Modbus/Uni-Telway, EtherNet/IP, DeviceNet, PROFIBUS DP, PROFIBUS DP V1, INTERBUS S, CC-Link,   | Modbus TCP, Fipio, Modbus/Uni-Telway, Modbus Plus, EtherNet/IP, DeviceNet, PROFIBUS DP, PROFIBUS DP V1, INTERBUS S, CC-Link,   | Modbus TCP, Fipio, Modbus/Uni-Telway, Modbus Plus, EtherNet/IP, DeviceNet, PROFIBUS DP, PROFIBUS DP V1, INTERBUS S, CC-Link, Lonworks, METASYS N2, APOGEE FLN P1, BACnet   | <b>HVAC protocols :</b> LonWorks, BACnet, METASYS N2, APOGEE FLN P1<br><b>Industrial protocols:</b> Modbus TCP, Modbus/Uni-Telway, Fipio, Modbus Plus, PROFIBUS DP, PROFIBUS DP V1, DeviceNet, Ethernet IP, CC-Link, INTERBUS   |
| IEC/EN 61800-5-1, IEC/EN 61800-3 (environments 1 and 2, Categories C2 and C3), UL508C, EN 954-1 Category 3, ISO/EN 13849-1/-2 Category 3 (PL d), IEC 61800-5-2, IEC 61508 (parts 1&2) level SIL1 SIL2 SIL3, draft standard EN 50495E, CE, UL, CSA, C-Tick, GOST, NOM.   | IEC/EN 61800-3, EN 55011, EN 55022, CSA, UL, C-TICK, CE, NOM, DNV, GOST  | IEC/EN 61800-3, EN 55011, EN 55022, CSA, UL, C-TICK, CE, NOM, DNV, GOST  | IEC/EN 61800-3, EN 55011, EN 55022, CSA, UL, C-TICK, CE, NOM, DNV, GOST  | IEC/EN 61800-3, EN 55011, EN 55022, CSA, UL, C-TICK, CE, NOM, DNV, GOST   |
| Machines  | Machines, industrial processes and infrastructures   | Machines, industrial processes or infrastructures  | Buildings and infrastructures  | Building or infrastructures   |

# Selection guide

## Specialized drives - Low voltage

### HVAC

⇒ *Applications:*

Range specifically for HVAC applications (heating, ventilation, air conditioning) in buildings.

### Lifts

⇒ *Applications:*

Lifts

### Altivar 212



Variable speed drives for three-phase asynchronous motors.  
Variable torque building HVAC applications.

### Altivar LIFT



Variable speed drives for lifts.

#### Description

- **Compact size:** side-by-side mounting
- **Simplicity :** Dedicated HVAC functions and remote graphic keypad option
- **Openness :** Integrated communications for building management systems
- **EMC filters** built-in
- **Reduction of the total harmonic distortion** THDI<30%
- **Protection class:** IP21 and IP55

- **Quick start-up** and easy diagnostics with the multi-language graphic display terminal and dedicated Lift configuration menu.
- **Dedicated Lift functions** for greater comfort and safety
- **Energy saving:** Control of energy efficient permanent magnet synchronous motors

#### Technical information

Power range for 50...60 Hz supply

0.75...75 kW

4...22 kW

Voltage

Three-phase 200...480 V

Single-phase 200...240 V  
Three-phase 200...480 V

Drive/Output frequency

0.5...200 Hz

0...599 Hz

Number of quadrants

—

—

Cooling system

—

—

Protection class

—

—

Motor type

Asynchronous

Yes

Yes

Synchronous

No

Yes

#### Communication

Integrated

Modbus, METASYS N2, APOGEE FLN P1, BACnet

Modbus and CANopen

As an option

Lonworks

Modbus TCP, Modbus/Uni-Telway, EtherNet/IP, DeviceNet, PROFIBUS DP, PROFIBUS DP V1, INTERBUS S, CC-Link

#### Standards and certifications

IEC/EN 61800-3, EN 55011, EN 55022, CSA, UL, C-TICK, CE, NOM

IEC/EN 61800-3, EN55011, EN 55022, CSA, UL, C-TICK, CE, NOM et EN81-1 (chap 12.7.3)





#### Intended use

Buildings

Machines

3

## Integrated variable speed control solutions

| Pumps and Fans<br>Low voltage   | Pumps and Fans<br>Medium voltage   | Complex machines/Special<br>machines Low voltage  | Complex machines/Special<br>machines Medium voltage  |
|---|--|---|--|
| <p>⇒ <i>Applications:</i></p> <ul style="list-style-type: none"> <li>• Fans</li> <li>• Pumps</li> <li>• Compressors</li> <li>• Screw feeders</li> </ul>   | <p>⇒ <i>Applications:</i></p> <ul style="list-style-type: none"> <li>• Energy: fans, pumps, turbine starters</li> <li>• Oil and gas: pumps, compressors, air blowers, extruders</li> <li>• Mines and Minerals: conveyors, crushers, fans, pumps</li> <li>• Water treatment: pumps, air blowers.</li> </ul> | <p>⇒ <i>Applications:</i></p> <ul style="list-style-type: none"> <li>• Fans</li> <li>• Pumps</li> <li>• Compressors</li> <li>• Screw feeders</li> </ul>   | <p>⇒ <i>Applications:</i></p> <ul style="list-style-type: none"> <li>• Energy: fans, pumps, turbine starters</li> <li>• Oil and gas: pumps, compressors, air blowers, extruders</li> <li>• Mines and Minerals: conveyors, crushers, fans, pumps</li> <li>• Water treatment: pumps, air blowers.</li> </ul> |
| <p><b>Altivar 61 Plus</b></p>  <p>High power low voltage variable speed drives for buildings and infrastructures.<br/><b>Variable torque</b></p>  | <p><b>Altivar 1100</b></p>  <p>Medium voltage variable speed drives for asynchronous motors (quotation on request)</p>  | <p><b>Altivar 71 Plus</b></p>  <p>High power low voltage variable speed drives for industry.<br/><b>Constant torque</b></p>  | <p><b>Altivar 1000</b></p>  <p>Medium voltage variable speed drives for asynchronous motors (quotation on request)</p>  |
| <p><b>A simple, open range:</b></p> <ul style="list-style-type: none"> <li>• Greater flexibility: numerous possible options and communication on most industrial networks</li> <li>• Easy configuration</li> <li>• Ready to use</li> </ul> <p><b>Maximum safety:</b> the <b>Altivar Plus</b> range has a cooling system and components that have been tested in extreme conditions.</p> <p><b>Time savings on:</b></p> <ul style="list-style-type: none"> <li>• Creating quotes</li> <li>• Placing orders</li> <li>• Installation and start-up</li> </ul> | <p><b>Environmentally-friendly and Cost-effective:</b></p> <ul style="list-style-type: none"> <li>• Perfect integration in the line supply</li> <li>• No disturbance of the motor and the driven load</li> <li>• High efficiency</li> </ul> <p><b>Easy to install and set up</b></p> <p><b>Compact</b></p> | <p><b>A simple, open range:</b></p> <ul style="list-style-type: none"> <li>• Greater flexibility: numerous possible options and communication on most industrial networks</li> <li>• Easy configuration</li> <li>• Ready to use</li> </ul> <p><b>Maximum safety:</b> the <b>Altivar Plus</b> range has a cooling system and components that have been tested in extreme conditions.</p> <p><b>Time savings on:</b></p> <ul style="list-style-type: none"> <li>• Creating quotes</li> <li>• Placing orders</li> <li>• Installation and start-up</li> </ul> | <p><b>High efficiency</b></p> <p>For use in <b>harsh environments</b></p> <p><b>Open</b> to all communication networks</p>   |
| 90...2400 kW  | 0.3...10.5 MW  | 90...2000 kW  | 0.5...10 MW  |
| Three-phase 380...690 V   | 3,3 kV<br>6,6 kV<br>10 kV  | Three-phase 380...690 V   | 2.4 kV<br>3.3 kV   |
| 0.1...500 Hz  | Standard : 0,2...60 Hz<br>Option : 0,2...120 Hz  | 0...500 Hz  | Standard: 5...70 Hz<br>Option: 5...140 Hz  |
| 2 and 4   | 2  | 2 and 4   | 2 and 4  |
| Air or water cooled   | Air cooled   | Air or water cooled   | Air or water cooled  |
| IP23/IP54<br>IP55 (water cooled)  | IP31<br>IP41 (option)  | IP23/IP54<br>IP55 (water cooled)  | IP41 (air cooled)<br>IP54 (water cooled)   |
| Yes   | Yes  | Yes   | Yes  |
| Yes   | No   | Yes   | No   |
| Modbus and CANopen  | PROFIBUS, Modbus   | Modbus and CANopen  | Ethernet, PROFIBUS, Modbus   |
| Modbus TCP, Fipio, Modbus/Uni-Telway, Modbus Plus, EtherNet/IP, DeviceNet, PROFIBUS DP, PROFIBUS DP V1, INTERBUS S, CC-Link, Lonworks, METASYS N2, APOGEE FLN P1, BACnet  | Ethernet, Devicenet, EtherNet/IP, etc.   | Modbus TCP, Fipio, Modbus/Uni-Telway, Modbus Plus, EtherNet/IP, DeviceNet, PROFIBUS DP, PROFIBUS DP V1, INTERBUS S, CC-Link   | Devicenet, CANopen   |
| IEC/EN 61800-5-1, IEC/EN 61800-3 (environments 1 and 2), IEC/EN 61000-4-2, -4-3, -4-5, -4-6 (level 3), IEC/EN 61000-4-4 (level 4), IEC/EN 60529, IEC 60721-3-3 class 3C2 and 3S2, CE, DNV, GOST   | IEC/EN 61800-5-1, IEC/EN 61800-4, IEC/EN 61800-3 (environnements 1 and 2, catégories C1 to C3), IEEE 519, IEC/EN 60204-11 and IEC/EN 60529   | IEC/EN 61800-5-1, IEC/EN 61800-3 (environments 1 and 2), IEC/EN 61000-4-2, -4-3, -4-5, -4-6 (level 3), IEC/EN 61000-4-4 (level 4), IEC/EN 60529, IEC 60721-3-3 class 3C2 and 3S2, CE, DNV and GOST  | IEC/EN 61800-5-1, IEC/EN 61800-4, IEC/EN 61800-3 (environments 1 and 2, categories C1 to C3), CE   |
| Buildings and infrastructures   | Infrastructures  | Machines, industrial processes and infrastructures  | Machines, industrial processes and infrastructures   |



| Dimensions (in mm) |                        | width x height x depth |
|--------------------|------------------------|------------------------|
| ATS01              | N103FT/N106 FT         | 22.5 x 100 x 100.4     |
|                    | N109FT/N112 FT/N125 FT | 45 x 124 x 130.7       |
|                    | N206●●/N209●●/N212●●   | 45 x 154 x 130.7       |
|                    | N222●●/N232●●          |                        |

| Type                         | Soft start units                      | Soft start/soft stop units                     |
|------------------------------|---------------------------------------|--|
| Motor power                  | 0.37 to 11 kW                         | 0.75 to 15 kW                                  |
| Degree of protection         | IP20                                  |  |
| Reduction of current peaks   | 1 controlled phase                    | 2 controlled phases                            |
| Adjustable starting time     | 1...5 s                               | 1...10 s                                       |
| Adjustable deceleration time | Freewheel stop                        | 1... 10 s                                      |
| Adjustable breakaway torque  | 30...80% of DOL motor starting torque |  |
| Logic inputs                 | –                                     | 3 logic inputs (start, stop and startup boost) |
| Logic outputs                | –                                     | 1 logic output                                 |
| Relay outputs                | –                                     | 1 relay output                                 |
| Control supply voltage       | 110... 220 VAC ± 10%, 24 VDC ± 10%    |  |

### Soft starters for 0.37 to 11 kW motors

| Motor   |         |       |       |       |       | Starter<br>Nominal current | Reference (2) |
|---|---------|-------|-------|-------|-------|----------------------------|---------------|
| Motor power (1)   |         |       |       |       |       |                            |               |
| Single phase  | 3-phase |       |       |       |       |                            |               |
| 230 V   | 210 V   | 230 V | 230 V | 400 V | 460 V |                            |               |
| kW  | HP      | kW    | HP    | kW    | HP    | A                          |               |
| <b>Single phase 110...230 V or 3-phase 110...480 V supply voltage, 50/60 Hz</b> |         |       |       |       |       |                            |               |
| 0,37  | –       | 0,37  | 0,5   | 1,1   | 0,5   | 3                          | ATS 01N103FT  |
|   |         | 0,55  | –     | –     | 1,5   |                            |               |
| 0,75  | 0,5     | 0,75  | 1     | 2,2   | 2     | 6                          | ATS 01N106FT  |
|   |         | 1,1   | 1,5   | 3     | 3     |                            |               |
| 1,1   | 1       | 1,5   | 2     | 4     | 5     | 9                          | ATS 01N109FT  |
| 1,5   | 1,5     | 2,2   | 3     | 5,5   | 7,5   | 12                         | ATS 01N112FT  |
| 2,2   | 2       | 3     | 5     | 7,5   | 10    | 25                         | ATS 01N125FT  |
|   | 3       | 4     | 7,5   | 9     | 15    |                            |               |
|   |         | 5,5   |       | 11    |       |                            |               |

### Soft start/soft stop units for 0.75 to 15 kW motors (3)

| Motor   |       | Starter<br>Nominal current | Reference (2) |
|---|-------|----------------------------|---------------|
| Motor power (1)                                     |       |                            |               |
| kW  | HP    | A                          |               |
| <b>3-phase supply voltage: 200...240 V 50/60 Hz</b> |       |                            |               |
| 0,75/1,1  | 1/1,5 | 6                          | ATS 01N206LU  |
| 1,5   | 2     | 9                          | ATS 01N209LU  |
| 2,2/3   | 3/–   | 12                         | ATS 01N212LU  |
| 4/5,5   | 5/7,5 | 22                         | ATS 01N222LU  |
| 7,5   | 10    | 32                         | ATS 01N232LU  |
| <b>3-phase supply voltage: 380...415 V 50/60 Hz</b> |       |                            |               |
| 1,5/2,2/3   | –     | 6                          | ATS 01N206QN  |
| 4   | –     | 9                          | ATS 01N209QN  |
| 5,5   | –     | 12                         | ATS 01N212QN  |
| 7,5/11  | –     | 22                         | ATS 01N222QN  |
| 15  | –     | 32                         | ATS 01N232QN  |
| <b>3-phase supply voltage: 440...480 V 50/60 Hz</b> |       |                            |               |
| –   | 2/3   | 6                          | ATS 01N206RT  |
| –   | 5     | 9                          | ATS 01N209RT  |
| –   | 7,5   | 12                         | ATS 01N212RT  |
| –   | 10/15 | 22                         | ATS 01N222RT  |
| –   | 20    | 32                         | ATS 01N232RT  |

(1) Standard power ratings of motors, HP power ratings indicated according to standard UL 508.

(2) For thermal protection of the motor, please use a thermal circuit-breaker GVp ME, GV3 P or GV7 RE (see combinations pages 60545/2 and 60545/3).

(3) Control power supply built into the starter.

## Starters with TeSys model U



| Dimensions (in mm)          | width x height x depth |
|-----------------------------|------------------------|
| ATSU01 N206LT/N209LT/N212LT | 45 x 124 x 130.7       |
| N222LT/N232LT               | 45 x 154 x 130.7       |

| Type                                   |     | Soft start/soft stop units                     |                                  |                                   |                                      |
|--|-----|--|----------------------------------|-----------------------------------|--------------------------------------|
| Motor power                            |     | 0.75 to 15 kW                                  |                                  |                                   |                                      |
| Degree of protection                   |     | IP20   |                                  |                                   |                                      |
| Reduction of current peaks             |     | Yes  |                                  |                                   |                                      |
| Adjustable starting and stopping times |     | 1...10 s                                       |                                  |                                   |                                      |
| Adjustable breakaway torque            |     | 30... 80% of DOL motor starting torque         |                                  |                                   |                                      |
| Logic inputs                           |     | 3 logic inputs (start, stop and startup boost) |                                  |                                   |                                      |
| Logic outputs                          |     | 1 logic output                                 |                                  |                                   |                                      |
| Relay outputs                          |     | 1 relay output                                 |                                  |                                   |                                      |
| Control supply voltage                 |     | 24 VDC, 100 mA, ± 10%                          |                                  |                                   |                                      |
| References                             |     | Soft start/soft stop units                     | TeSys starter-controller model U | Power connector                   |                                      |
|  |     |  | Power base                       | Control unit (1)                  | between ATSU and TeSys model U       |
| Supply voltage                         |     | Three-phase 200...480 V                        |                                  |                                   |                                      |
| Motor power                            |     |  |                                  |                                   |                                      |
| 230 V                                  |     | 400 V  | 460 V                            | Nominal current (I <sub>N</sub> ) |                                      |
| kW                                     | HP  | kW   | HP                               |                                   |                                      |
| 0.75                                   | 1   | 1.5  | 2                                | 6 A                               | ATSU01N206LT LUB12 LUC●05BL VW3G4104 |
| 1.1                                    | 1.5 | 2.2/3  | 3                                | 6 A                               | ATSU01N206LT LUB12 LUC●12BL VW3G4104 |
| 1.5                                    | 2   | –  | 5                                | 9 A                               | ATSU01N209LT LUB12 LUC●12BL VW3G4104 |
| –                                      | –   | 4  | –                                | 9 A                               | ATSU01N209LT LUB12 LUC●12BL VW3G4104 |
| 2.2                                    | 3   | 5.5  | 7.5                              | 12 A                              | ATSU01N212LT LUB12 LUC●12BL VW3G4104 |
| 3                                      | –   | –  | –                                | 12 A                              | ATSU01N212LT LUB32 LUC●18BL VW3G4104 |
| 4                                      | 5   | 7.5  | 10                               | 22 A                              | ATSU01N222LT LUB32 LUC●18BL VW3G4104 |
| 5.5                                    | 7.5 | 11   | 15                               | 22 A                              | ATSU01N222LT LUB32 LUC●32BL VW3G4104 |
| 7.5                                    | 10  | 15   | 20                               | 32 A                              | ATSU01N232LT LUB32 LUC●32BL VW3G4104 |

(1) To compose your reference, replace ● in the reference with: «A» for a standard control unit, «M» for a multifunction unit and «B» for an advanced unit.





| Dimensions (in mm) |            | width x height x depth |                 |
|--------------------|------------|------------------------|-----------------|
| ATS22              | D17 to D47 | Size A:                | 130 x 265 x 169 |
|                    | D62 to D88 | Size B:                | 145 x 295 x 207 |
|                    | C11 to C17 | Size C:                | 150 x 356 x 229 |
|                    | C21 to C41 | Size D:                | 206 x 425 x 299 |
|                    | C48 to C59 | Size E:                | 304 x 455 x 340 |

| Supply voltage               |                             | Three-phase 208...600 V   | Three-phase 230...440 V   |
|------------------------------|-----------------------------|---|---|
| <b>Protection</b>            | Degree of protection        | IP20: for ATS 22D17●●●D88 starters<br>IP00: for ATS 22C11●●●C59 starters (protection of terminals available as an option) |   |
|                              | Motor thermal protection    | Class 10, 20 or 30 (1)  |   |
| Drive                        | Number of controlled phases | 3   |   |
|                              | Types of control            | Configurable voltage ramp, torque ramp  |   |
|                              | Operating cycle             | Standard  |   |
| Functions                    |                             | Integrated Bypass contactor   |   |
| Number of I/O                | Analog inputs               | 1 PTC probe   |   |
|                              | Logic inputs                | 3   |   |
|                              | Logic outputs               | -   |   |
|                              | Analog outputs              | -   |   |
|                              | Relay outputs               | 2   |   |
| Dialogue                     |                             | Integrated display terminal, SoMove setup software  |   |
| <b>Communication</b>         | Integrated                  | Modbus  |   |
| Standards and certifications |                             | IEC/EN 60947-4-2, class A EMC, CE, UL, CSA, C-Tick, GOST, CCC, ABS  |   |
| Motor connection             |                             |   | Possible to connect the starter in the motor delta connection (2) |

(1) Soft starter sizing according to thermal protection class

| Starting current  | Protection class |              |               |
|-------------------|------------------|--------------|---------------|
|                   | Class 10         | Class 20     | Class 30      |
| < = 3.5 In        | Nominal*         | Nominal +1** | Nominal +2*** |
| max starting time | 16s              | 32s          | 48s           |

\* nominal size of the soft starter acc. to the nominal motor current (Motor FLA)

\*\* oversize of the soft starter by 1 rating compared to the nominal motor current (Motor FLA)

\*\*\* oversize of the soft starter by 2 ratings compared to the nominal motor current (Motor FLA)

(2) please find the references details in ATS22 catalogue for motor delta connection



| Connection in the motor power supply line |             |             |                                  | Soft start/soft stop unit 230...440 V - 50/60 Hz |        |
|---|-------------|-------------|----------------------------------|--|--------|
| Motor                                     |             |             |                                  |  |        |
| Power indicated on rating plate           |             |             |                                  |  |        |
| 230 V<br>kW                               | 400 V<br>kW | 440 V<br>kW | Nominal current<br>starter (IcL) | Reference  | Size   |
| 4   | 7.5         | 7.5         | 17                               | ATS22D17Q  | Size A |
| 7.5                                       | 15          | 15          | 32                               | ATS22D32Q  | Size A |
| 11  | 22          | 22          | 47                               | ATS22D47Q  | Size A |
| 15  | 30          | 30          | 62                               | ATS22D62Q  | Size B |
| 18.5                                      | 37          | 37          | 75                               | ATS22D75Q  | Size B |
| 22  | 45          | 45          | 88                               | ATS22D88Q  | Size B |
| 30  | 55          | 55          | 110                              | ATS22C11Q  | Size C |
| 37  | 75          | 75          | 140                              | ATS22C14Q  | Size C |
| 45  | 90          | 90          | 170                              | ATS22C17Q  | Size C |
| 55  | 110         | 110         | 210                              | ATS22C21Q  | Size D |
| 75  | 132         | 132         | 250                              | ATS22C25Q  | Size D |
| 90  | 160         | 160         | 320                              | ATS22C32Q  | Size D |
| 110                                       | 220         | 220         | 410                              | ATS22C41Q  | Size D |
| 132                                       | 250         | 250         | 480                              | ATS22C48Q  | Size E |
| 160                                       | 315         | 355         | 590                              | ATS22C59Q  | Size E |

| Connection in the motor power supply line |       |       |       |       |       |       |       |       |       |       | Soft start/soft stop unit 208...600 V - 50/60 Hz |             |            |            |        |
|---|-------|-------|-------|-------|-------|-------|-------|-------|-------|-------|--|-------------|------------|------------|--------|
| Motor                                     |       |       |       |       |       |       |       |       |       |       | 208...600 V                                      |             | 230...600V |            |        |
| Motor power                               |       |       |       |       |       |       |       |       |       |       | Control power supplyS6                           |             |            |            |        |
| 208 V                                     | 230 V | 460 V | 575 V | 230 V | 400 V | 440 V | 500 V | 525 V | 660 V | 690 V | Nominal<br>current<br>(IcL)                      | 110 V       |            | 220 V      |        |
| HP  |       |       |       | kW    |       |       |       |       |       |       |  | Reference   | Size       | Reference  | Size   |
| 3   | 5     | 10    | 15    | 4     | 7.5   | 7.5   | 9     | 9     | 11    | 15    | 17 A   | ATS22D17S6U | Size A     | ATS22D22S6 | Size A |
| 7.5                                       | 10    | 20    | 25    | 7.5   | 15    | 15    | 18.5  | 18.5  | 22    | 22    | 32 A   | ATS22D32S6U | Size A     | ATS22D38S6 | Size A |
| –   | 15    | 30    | 40    | 11    | 22    | 22    | 30    | 30    | 37    | 37    | 47 A   | ATS22D47S6U | Size A     | ATS22D62S6 | Size A |
| 15  | 20    | 40    | 50    | 15    | 30    | 30    | 37    | 37    | 45    | 45    | 62 A   | ATS22D62S6U | Size B     | ATS22D75S6 | Size B |
| 20  | 25    | 50    | 60    | 18.5  | 37    | 37    | 45    | 45    | 55    | 55    | 75 A   | ATS22D75S6U | Size B     | ATS22D88S6 | Size B |
| 25  | 30    | 60    | 75    | 22    | 45    | 45    | 55    | 55    | 75    | 75    | 88 A   | ATS22D88S6U | Size B     | ATS22C11S6 | Size B |
| 30  | 40    | 75    | 100   | 30    | 55    | 55    | 75    | 75    | 90    | 90    | 110 A  | ATS22C11S6U | Size C     | ATS22C14S6 | Size C |
| 40  | 50    | 100   | 125   | 37    | 75    | 75    | 90    | 90    | 110   | 110   | 140 A  | ATS22C14S6U | Size C     | ATS22C17S6 | Size C |
| 50  | 60    | 125   | 150   | 45    | 90    | 90    | 110   | 110   | 132   | 160   | 170 A  | ATS22C17S6U | Size C     | ATS22C21S6 | Size C |
| 60  | 75    | 150   | 200   | 55    | 110   | 110   | 132   | 132   | 160   | 200   | 210 A  | ATS22C21S6U | Size D     | ATS22C25S6 | Size D |
| 75  | 100   | 200   | 250   | 75    | 132   | 132   | 160   | 160   | 220   | 250   | 250 A  | ATS22C25S6U | Size D     | ATS22C32S6 | Size D |
| 100                                       | 125   | 250   | 300   | 90    | 160   | 160   | 220   | 220   | 250   | 315   | 320 A  | ATS22C32S6U | Size D     | ATS22C41S6 | Size D |
| 125                                       | 150   | 300   | 350   | 110   | 220   | 220   | 250   | 250   | 355   | 400   | 410 A  | ATS22C41S6U | Size D     | ATS22C48S6 | Size D |
| 150                                       | –     | 350   | 400   | 132   | 250   | 250   | 315   | 315   | 400   | 500   | 480 A  | ATS22C48S6U | Size E     | ATS22C59S6 | Size E |
| –   | 200   | 400   | 500   | 160   | 315   | 355   | 400   | 400   | 560   | 560   | 590 A  | ATS22C59S6U | Size E     | ATS22C66S6 | Size E |

| Dimensions (in mm) | width x height x depth         |
|--------------------|--------------------------------|
| ATS48 D17Q to D47Q | <b>Size A:</b> 160 x 275 x 190 |
| D62Q to C11Q       | <b>Size B:</b> 190 x 290 x 235 |
| C14Q to C17Q       | <b>Size C:</b> 200 x 340 x 265 |
| C21Q to C32Q       | <b>Size D:</b> 320 x 380 x 265 |
| C41Q to C66Q       | <b>Size E:</b> 400 x 670 x 300 |
| C79Q to M12Q       | <b>Size F:</b> 770 x 890 x 315 |



| Supply voltage                 |                          |                 | Three-phase 230...415 V (1)  |        |                 |        |
|--------------------------------|--------------------------|-----------------|--|--------|-----------------|--------|
| Type of application            |                          |                 | Standard   |        | Severe (2)      |        |
| Starter control supply voltage |                          |                 | 220...415 V  |        |                 |        |
| Protection                     | Degree of protection     |                 | IP20: ATS48D17● to ATS48C11● starters<br>IP00: ATS48C14● to ATS48M12● starters |        |                 |        |
|                                | Motor thermal protection |                 | Class 10   |        | Class 20 and 30 |        |
| EMC                            | Class A                  |                 | On all starters  |        |                 |        |
|                                | Class B                  |                 | On all starters up to 170 A  |        |                 |        |
| Starting mode                  |                          |                 | Torque control (patented TCS: Torque Control System)                           |        |                 |        |
| I/O                            | Analog inputs            |                 | 1 PTC probe  |        |                 |        |
|                                | Logic inputs             |                 | 4 logic inputs, 2 of which are configurable                                    |        |                 |        |
|                                | Logic outputs            |                 | 2 configurable logic outputs   |        |                 |        |
|                                | Analog outputs           |                 | 1 analog output  |        |                 |        |
|                                | Relay outputs            |                 | 3 relay outputs, 2 of which are configurable                                   |        |                 |        |
| Dialogue                       |                          |                 | Integrated or remote display terminal (in option), SoMove software workshop    |        |                 |        |
| Communication                  | Integrated               |                 | Modbus   |        |                 |        |
|                                | With gateway             |                 | DeviceNet, Ethernet, Fipio, PROFIBUS DP  |        |                 |        |
| Motor power                    |                          |                 |  |        |                 |        |
| 230 V                          | 400 V                    | Nominal current |  |        |                 |        |
| kW                             | kW                       | (IcL)           |  |        |                 |        |
| 3                              | 5.5                      | 12 A            | –  |        | ATS48D17Q       | Size A |
| 4                              | 7.5                      | 17 A            | ATS48D17Q  | Size A | ATS48D22Q       | Size A |
| 5.5                            | 11                       | 22 A            | ATS48D22Q  | Size A | ATS48D32Q       | Size A |
| 7.5                            | 15                       | 32 A            | ATS48D32Q  | Size A | ATS48D38Q       | Size A |
| 9                              | 18.5                     | 38 A            | ATS48D38Q  | Size A | ATS48D47Q       | Size A |
| 11                             | 22                       | 47 A            | ATS48D47Q  | Size A | ATS48D62Q       | Size B |
| 15                             | 30                       | 62 A            | ATS48D62Q  | Size B | ATS48D75Q       | Size B |
| 18.5                           | 37                       | 75 A            | ATS48D75Q  | Size B | ATS48D88Q       | Size B |
| 22                             | 45                       | 88 A            | ATS48D88Q  | Size B | ATS48C11Q       | Size B |
| 30                             | 55                       | 110 A           | ATS48C11Q  | Size B | ATS48C14Q       | Size C |
| 37                             | 75                       | 140 A           | ATS48C14Q  | Size C | ATS48C17Q       | Size C |
| 45                             | 90                       | 170 A           | ATS48C17Q  | Size C | ATS48C21Q       | Size D |
| 55                             | 110                      | 210 A           | ATS48C21Q  | Size D | ATS48C25Q       | Size D |
| 75                             | 132                      | 250 A           | ATS48C25Q  | Size D | ATS48C32Q       | Size D |
| 90                             | 160                      | 320 A           | ATS48C32Q  | Size D | ATS48C41Q       | Size E |
| 110                            | 220                      | 410 A           | ATS48C41Q  | Size E | ATS48C48Q       | Size E |
| 132                            | 250                      | 480 A           | ATS48C48Q  | Size E | ATS48C59Q       | Size E |
| 160                            | 315                      | 590 A           | ATS48C59Q  | Size E | ATS48C66Q       | Size E |
| –                              | 355                      | 660 A           | ATS48C66Q  | Size E | ATS48C79Q       | Size F |
| 220                            | 400                      | 790 A           | ATS48C79Q  | Size F | ATS48M10Q       | Size F |
| 250                            | 500                      | 1000 A          | ATS48M10Q  | Size F | ATS48M12Q       | Size F |
| 355                            | 630                      | 1200 A          | ATS48M12Q  | Size F | –               |        |

(1) Possible to connect the starter in the motor delta connection

(2) Starting time greater than 30 seconds (fans, high inertia machines and compressors)

## Soft start/soft stop units

| Dimensions (in mm) |              | width x height x depth |                 |
|--------------------|--------------|------------------------|-----------------|
| ATS48              | D17Y to D47Y | <b>Size A:</b>         | 160 x 275 x 190 |
|                    | D62Y to C11Y | <b>Size B:</b>         | 190 x 290 x 235 |
|                    | C14Y to C17Y | <b>Size C:</b>         | 200 x 340 x 265 |
|                    | C21Y to C32Y | <b>Size D:</b>         | 320 x 380 x 265 |
|                    | C41Y to C66Y | <b>Size E:</b>         | 400 x 670 x 300 |
|                    | C79Y to M12Y | <b>Size F:</b>         | 770 x 890 x 315 |



| Supply voltage                 |       |       |       |       |       |       |       |       |       |       |        | Three-phase 208...690 V (1)       |        |            |        |  |
|--------------------------------|-------|-------|-------|-------|-------|-------|-------|-------|-------|-------|--------|-----------------------------------|--------|------------|--------|--|
| Type of application            |       |       |       |       |       |       |       |       |       |       |        | Standard                          |        | Severe (2) |        |  |
| Starter control supply voltage |       |       |       |       |       |       |       |       |       |       |        | 110...230 V                       |        |            |        |  |
| Characteristics                |       |       |       |       |       |       |       |       |       |       |        | Identical to 230...415 V starters |        |            |        |  |
| Motor power                    |       |       |       |       |       |       |       |       |       |       |        | Nominal current (IcL)             |        |            |        |  |
| 208 V                          | 230 V | 460 V | 575 V | 230 V | 400 V | 440 V | 500 V | 525 V | 660 V | 690 V |        |                                   |        |            |        |  |
| HP                             |       |       |       | kW    |       |       |       |       |       |       |        |                                   |        |            |        |  |
| 2                              | 3     | 7.5   | 10    | 3     | 5.5   | 5.5   | 7.5   | 7.5   | 9     | 11    | 12 A   | –                                 |        | ATS48D17Y  | Size A |  |
| 3                              | 5     | 10    | 15    | 4     | 7.5   | 7.5   | 9     | 9     | 11    | 15    | 17 A   | ATS48D17Y                         | Size A | ATS48D22Y  | Size A |  |
| 5                              | 7.5   | 15    | 20    | 5.5   | 11    | 11    | 11    | 11    | 15    | 18.5  | 22 A   | ATS48D22Y                         | Size A | ATS48D32Y  | Size A |  |
| 7.5                            | 10    | 20    | 25    | 7.5   | 15    | 15    | 18.5  | 18.5  | 22    | 22    | 32 A   | ATS48D32Y                         | Size A | ATS48D38Y  | Size A |  |
| 10                             | –     | 25    | 30    | 9     | 18.5  | 18.5  | 22    | 22    | 30    | 30    | 38 A   | ATS48D38Y                         | Size A | ATS48D47Y  | Size A |  |
| –                              | 15    | 30    | 40    | 11    | 22    | 22    | 30    | 30    | 37    | 37    | 47 A   | ATS48D47Y                         | Size A | ATS48D62Y  | Size B |  |
| 15                             | 20    | 40    | 50    | 15    | 30    | 30    | 37    | 37    | 45    | 45    | 62 A   | ATS48D62Y                         | Size B | ATS48D75Y  | Size B |  |
| 20                             | 25    | 50    | 60    | 18.5  | 37    | 37    | 45    | 45    | 55    | 55    | 75 A   | ATS48D75Y                         | Size B | ATS48D88Y  | Size B |  |
| 25                             | 30    | 60    | 75    | 22    | 45    | 45    | 55    | 55    | 75    | 75    | 88 A   | ATS48D88Y                         | Size B | ATS48C11Y  | Size B |  |
| 30                             | 40    | 75    | 100   | 30    | 55    | 55    | 75    | 75    | 90    | 90    | 110 A  | ATS48C11Y                         | Size B | ATS48C14Y  | Size C |  |
| 40                             | 50    | 100   | 125   | 37    | 75    | 75    | 90    | 90    | 110   | 110   | 140 A  | ATS48C14Y                         | Size C | ATS48C17Y  | Size C |  |
| 50                             | 60    | 125   | 150   | 45    | 90    | 90    | 110   | 110   | 132   | 160   | 170 A  | ATS48C17Y                         | Size C | ATS48C21Y  | Size D |  |
| 60                             | 75    | 150   | 200   | 55    | 110   | 110   | 132   | 132   | 160   | 200   | 210 A  | ATS48C21Y                         | Size D | ATS48C25Y  | Size D |  |
| 75                             | 100   | 200   | 250   | 75    | 132   | 132   | 160   | 160   | 220   | 250   | 250 A  | ATS48C25Y                         | Size D | ATS48C32Y  | Size D |  |
| 100                            | 125   | 250   | 300   | 90    | 160   | 160   | 220   | 220   | 250   | 315   | 320 A  | ATS48C32Y                         | Size D | ATS48C41Y  | Size E |  |
| 125                            | 150   | 300   | 350   | 110   | 220   | 220   | 250   | 250   | 355   | 400   | 410 A  | ATS48C41Y                         | Size E | ATS48C48Y  | Size E |  |
| 150                            | –     | 350   | 400   | 132   | 250   | 250   | 315   | 315   | 400   | 500   | 480 A  | ATS48C48Y                         | Size E | ATS48C59Y  | Size E |  |
| –                              | 200   | 400   | 500   | 160   | 315   | 355   | 400   | 400   | 560   | 560   | 590 A  | ATS48C59Y                         | Size E | ATS48C66Y  | Size E |  |
| 200                            | 250   | 500   | 600   | –     | 355   | 400   | –     | –     | 630   | 630   | 660 A  | ATS48C66Y                         | Size E | ATS48C79Y  | Size F |  |
| 250                            | 300   | 600   | 800   | 220   | 400   | 500   | 500   | 500   | 710   | 710   | 790 A  | ATS48C79Y                         | Size F | ATS48M10Y  | Size F |  |
| 350                            | 350   | 800   | 1000  | 250   | 500   | 630   | 630   | 630   | 900   | 900   | 1000 A | ATS48M10Y                         | Size F | ATS48M12Y  | Size F |  |
| 400                            | 450   | 1000  | 1200  | 355   | 630   | 710   | 800   | 800   | –     | –     | 1200 A | ATS48M12Y                         | Size F | –          |        |  |

(1) Starter connection in the motor delta connection: up to 500 V only, add "S316" at the end of the reference

(2) Starting time greater than 30 seconds (fans, high inertia machines and compressors)

# Altivar 12

0.18...4 kW

## Simple machines Ultra-compact drives



| Dimensions (in mm) |                   | width x height x depth |                   |
|--------------------|-------------------|------------------------|-------------------|
| <b>1C1:</b>        | 72 x 143 x 102.2  | <b>2F3:</b>            | 105 x 143 x 131.2 |
| <b>1C2:</b>        | 72 x 143 x 102.2  | <b>3F3:</b>            | 140 x 184 x 141.2 |
| <b>1C3:</b>        | 72 x 143 x 121.2  |                        |                   |
| <b>2C1:</b>        | 105 x 142 x 156.2 |                        |                   |
| <b>2C2:</b>        | 105 x 142 x 156.2 |                        |                   |

| Type of drive                         |                         | Single-phase<br>120 V   |                              | Single-phase<br>240 V  |                     | Three-phase<br>240 V |                 |     |
|---------------------------------------|-------------------------|---|------------------------------|--|---------------------|----------------------|-----------------|-----|
| <b>Supply voltage</b>                 |                         |   |                              |  |                     |                      |                 |     |
| <b>Degree of protection</b>           |                         | IP20  |                              |  |                     |                      |                 |     |
| <b>Drive</b>                          | Output frequency        | 0.5... 400 Hz   |                              |  |                     |                      |                 |     |
|                                       | Type of control         | Asynchronous motor  |                              | U/F, sensorless flux vector control, quadratic Kn <sup>2</sup> |                     |                      |                 |     |
|                                       | Transient overtorque    | 150...170 of the nominal torque   |                              |  |                     |                      |                 |     |
| <b>Speed range</b>                    |                         | 1 to 20   |                              |  |                     |                      |                 |     |
| <b>Functions</b>                      | Number of functions     | 40  |                              |  |                     |                      |                 |     |
|                                       | Number of preset speeds | 8   |                              |  |                     |                      |                 |     |
|                                       | Number of I/O           | Analog inputs   | 1 configurable analog input  |  |                     |                      |                 |     |
|                                       |                         | Logic inputs  | 4 assignable logic inputs    |  |                     |                      |                 |     |
|                                       |                         | Analog outputs  | 1 configurable analog output |  |                     |                      |                 |     |
|                                       | Relay outputs           | 1 protected relay logic output  |                              |  |                     |                      |                 |     |
| <b>Dialogue</b>                       |                         | Integrated or remote display terminal, SoMove software workshop, or mobile phone via Bluetooth® |                              |  |                     |                      |                 |     |
| <b>Communication</b>                  | Integrated              | Modbus  |                              |  |                     |                      |                 |     |
| <b>Cards (available as an option)</b> |                         |   |                              |  |                     |                      |                 |     |
| <b>Reduction of current harmonics</b> |                         |   |                              |  |                     |                      |                 |     |
| <b>EMC filter</b>                     | Integrated              |   |                              | C1 EMC   |                     |                      |                 |     |
|                                       | As an option            |   |                              |  |                     |                      |                 |     |
| <b>Motor power</b>                    | kW/HP                   | 0.18/0.25   | ATV12H018F1 (1)              | 1C1  | ATV12H018M2 (1) (2) | 1C2                  | ATV12H018M3 (1) | 1C3 |
|                                       |                         | 0.37/0.5  | ATV12H037F1                  | 1C1  | ATV12H037M2 (2)     | 1C1                  | ATV12H037M3     | 1C3 |
|                                       |                         | 0.55/0.75   | –                            |  | ATV12H055M2 (2)     | 1C2                  | –               |     |
|                                       |                         | 0.75/1  | ATV12H075F1                  | 2C1  | ATV12H075M2 (2)     | 1C2                  | ATV12H075M3     | 1C3 |
|                                       |                         | 1.5/2   | –                            |  | ATV12HU15M2 (2)     | 2C2                  | ATV12H015M3     | 2F3 |
|                                       |                         | 2.2/3   | –                            |  | ATV12HU22M2 (2)     | 2C2                  | ATV12H022M3     | 2F3 |
|                                       |                         | 3/3   | –                            |  | –                   |                      | ATV12H030M3     | 3F3 |
|                                       |                         | 4/5   | –                            |  | –                   |                      | ATV12H040M3     | 3F3 |

(1) Because of the low heat dissipation, the ATV12H018.. is only supplied on a base plate

(2) Also exists as a multipack

| Dimensions (in mm)     |                      | width x height x depth |  |
|------------------------|----------------------|------------------------|--|
| IP21                   |                      | IP55                   |  |
| T1A: 107 x 143 x 150   | T1: 215 x 297 x 192  |                        |  |
| T2A: 142 x 184 x 150   | T2: 230 x 340 x 208  |                        |  |
| T3A: 180 x 232 x 170   | T3: 290 x 560 x 315  |                        |  |
| T4A: 245 x 329.5 x 190 | T4: 310 x 665 x 315  |                        |  |
| T5A: 240 x 420 x 214   | T5: 284 x 720 x 315  |                        |  |
| T6A: 320 x 630 x 290   | T5: 284 x 880 x 343  |                        |  |
| T7A: 240 x 550 x 266   | T5: 362 x 1000 x 364 |                        |  |
| T8A: 320 x 630 x 290   |                      |                        |  |



| Type of drive                    |                        | IP21   |                   | IP55  |                 |                  |
|----------------------------------|------------------------|--|-------------------|---|-----------------|------------------|
| Supply voltage                   |                        | 200...240 V  |                   | 380...480 V   |                 |                  |
| Degree of protection             |                        | IP21 and IP41 on the upper part  |                   | IP55 drive available in two manufacturing variants, ATV212W...N4 C1 EMC or ATV212W...N4C C2 EMC |                 |                  |
| Output frequency                 |                        | 0.5...200 Hz   |                   |   |                 |                  |
| Type of control                  |                        | Kn <sup>2</sup> quadratic ratio, sensorless flux vector control, voltage/frequency ratio (2 points), energy saving ratio |                   |   |                 |                  |
| Speed range                      |                        | 1 to 10  |                   |   |                 |                  |
| I/O                              | Analog inputs          | 1 switch-configurable current or voltage analog input and 1 voltage analog input, configurable as a PTC probe input      |                   |   |                 |                  |
|                                  | Logic inputs           | 3 programmable logic inputs  |                   |   |                 |                  |
|                                  | Analog outputs         | 1 switch-configurable current or voltage analog output   |                   |   |                 |                  |
|                                  | Relay outputs          | 2 relay logic outputs  |                   |   |                 |                  |
| Dialogue                         |                        | Integrated display terminal with local controls (1) or remote display terminal or PC software (3)                        |                   |   |                 |                  |
| Communication<br>(see page 4/11) | Integrated             | Modbus, APOGEE FLN P1, Metasys N2, BACnet  |                   |   |                 |                  |
|                                  | As an option           | LonWorks   |                   |   |                 |                  |
| EMC filter                       | Integrated             | –  | C2 EMC            | C2 EMC  | C1 EMC          |                  |
|                                  | Available as an option | C2 EMC   | C1 EMC            | –   | –               |                  |
| Motor power                      | kW/HP                  | 0.75/1   | ATV212H075M3X T1A | ATV212H075N4 T1A  | ATV212W075N4 T1 | ATV212W075N4C T1 |
|                                  |                        | 1.5/2  | ATV212HU15M3X T1A | ATV212HU15N4 T1A  | ATV212WU15N4 T1 | ATV212WU15N4C T1 |
|                                  |                        | 2.2/3  | ATV212HU22M3X T1A | ATV212HU22N4 T1A  | ATV212WU22N4 T1 | ATV212WU22N4C T1 |
|                                  |                        | 3/–  | ATV212HU30M3X T2A | ATV212HU30N4 T2A  | ATV212WU30N4 T2 | ATV212WU30N4C T2 |
|                                  |                        | 4/5  | ATV212HU40M3X T2A | ATV212HU40N4 T2A  | ATV212WU40N4 T2 | ATV212WU40N4C T2 |
|                                  |                        | 5.5/7.5  | ATV212HU55M3X T3A | ATV212HU55N4 T2A  | ATV212WU55N4 T2 | ATV212WU55N4C T2 |
|                                  |                        | 7.5/10   | ATV212HU75M3X T3A | ATV212HU75N4 T3A  | ATV212WU75N4 T2 | ATV212WU75N4C T2 |
|                                  |                        | 11/15  | ATV212HD11M3X T4A | ATV212HD11N4 T3A  | ATV212WD11N4 T3 | ATV212WD11N4C T3 |
|                                  |                        | 15/20  | ATV212HD15M3X T4A | ATV212HD15N4 T4A  | ATV212WD15N4 T3 | ATV212WD15N4C T3 |
|                                  |                        | 18.5/25  | ATV212HD18M3X T4A | ATV212HD18N4 T4A  | ATV212WD18N4 T4 | ATV212WD18N4C T4 |
|                                  |                        | 22/30 (4)  | –                 | ATV212HD22N4S T4A   | –               | –                |
|                                  |                        | 22/30  | ATV212HD22M3X T5A | ATV212HD22N4(2) T5A   | ATV212WD22N4 T5 | ATV212WD22N4C T5 |
|                                  |                        | 30/40  | ATV212HD30M3X T6A | ATV212HD30N4(2) T5A   | ATV212WD30N4 T5 | ATV212WD30N4C T5 |
|                                  |                        | 37/50  | –                 | ATV212HD37N4 T7A  | ATV212WD37N4 T6 | ATV212WD37N4C T6 |
|                                  |                        | 45/60  | –                 | ATV212HD45N4 T7A  | ATV212WD45N4 T6 | ATV212WD45N4C T6 |
|                                  |                        | 55/75  | –                 | ATV212HD55N4 T8A  | ATV212WD55N4 T7 | ATV212WD55N4C T7 |
| 75/100                           | –                      | ATV212HD75N4 T8A   | ATV212WD75N4 T7   | ATV212WD75N4C T7  |                 |                  |

(1) Drive with local controls, Run/Stop, Loc/Rem. keys

(2) For references ATV212HD22N4 and ATV212HD30N4, please refer to the Schneider Electric catalogue.

(3) PC Software is available as a free download from [www.schneider-electric.com](http://www.schneider-electric.com)

(4) Optimized size and weight



| Dimensions (in mm) |                 | width x height x depth |                 |
|--------------------|-----------------|------------------------|-----------------|
| T 1:               | 72 x 145 x 122  | T 6:                   | 107 x 143 x 152 |
| T 2:               | 72 x 145 x 132  | T 7:                   | 142 x 184 x 152 |
| T 3:               | 72 x 145 x 132  | T 8:                   | 180 x 232 x 172 |
| T 4:               | 72 x 145 x 142  | T 9:                   | 245 x 330 x 192 |
| T 5:               | 105 x 143 x 132 |                        |                 |

| Type of drive                         |                         | Single-phase 240 V   | Three-phase 240 V   | Three-phase 500V            | Three-phase 600V   |                 |   |
|---------------------------------------|-------------------------|--|---------------------|-----------------------------|--------------------|-----------------|---|
| Supply voltage                        |                         | with integrated EMC filters  | without EMC filter  | with integrated EMC filters | without EMC filter |                 |   |
| <b>Degree of protection</b>           |                         | IP31 & IP41 on upper part and IP21 on terminals  |                     |                             |                    |                 |   |
| <b>Drive</b>                          | Output frequency        | 0.5...500 Hz   |                     |                             |                    |                 |   |
|                                       | Type of control         | Asynchronous motor   |                     |                             |                    |                 |   |
|                                       | Transient overtorque    | Standard (voltage / frequency) - Performance (sensorless flux vector control)<br>Energy saving ratio, pump & Fan ratio (Kn <sup>2</sup> quadratic ratio)<br>170 ... 200% of the nominal motor torque |                     |                             |                    |                 |   |
| <b>Speed range</b>                    |                         | 1 to 50  |                     |                             |                    |                 |   |
| <b>Functions</b>                      | Number of functions     | 50   |                     |                             |                    |                 |   |
|                                       | Number of preset speeds | 16   |                     |                             |                    |                 |   |
|                                       | Number of I/O           | Analog inputs  | 3                   |                             |                    |                 |   |
|                                       |                         | Logic inputs   | 6                   |                             |                    |                 |   |
|                                       |                         | Analog outputs   | 1                   |                             |                    |                 |   |
|                                       |                         | Logic outputs  | -                   |                             |                    |                 |   |
| Relay outputs                         | 2                       |  |                     |                             |                    |                 |   |
| <b>Dialogue</b>                       |                         | Integrated 4-digit display, remote terminals (IP54 or IP65), Altivar 61/71 remote graphic display terminal   |                     |                             |                    |                 |   |
| <b>Communication</b>                  | Integrated              | Modbus and CANopen   |                     |                             |                    |                 |   |
|                                       | As an option            | CANopen Daisy chain, Modbus TCP, DeviceNet, PROFIBUS DP, Fipio   |                     |                             |                    |                 |   |
| <b>Reduction of current harmonics</b> |                         |  |                     |                             |                    |                 |   |
| <b>EMC filter</b>                     | Integrated              | C2 EMC   |                     | Integrated C2(1) or C3 EMC  |                    |                 |   |
|                                       | As an option            | C1 EMC   |                     | -                           |                    |                 |   |
| <b>Motor power</b>                    | kW/HP                   | 0.18/0.25  | ATV312H018M2 T3     | ATV312H018M3 T1             | -                  | -               |   |
|                                       |                         | 0.37/0.5   | ATV312H037M2 T3     | ATV312H037M3 T1             | ATV312H037N4 T5    | -               | - |
|                                       |                         | 0.55/0.75  | ATV312H055M2 T4     | ATV312H055M3 T2             | ATV312H055N4 T5    | -               | - |
|                                       |                         | 0.75/1   | ATV312H075M2 T4     | ATV312H075M3 T2             | ATV312H075N4 T6    | ATV312H075S6 T6 | - |
|                                       |                         | 1.1/1.5  | ATV312HU11M2 T6     | ATV312HU11M3 T5             | ATV312HU11N4 T6    | -               | - |
|                                       |                         | 1.5/2  | ATV312HU15M2 T6     | ATV312HU15M3 T5             | ATV312HU15N4 T6    | ATV312HU15S6 T6 | - |
|                                       |                         | 2.2/3  | ATV312HU22M2 (2) T7 | ATV312HU22M3 T6             | ATV312HU22N4 T7    | ATV312HU22S6 T7 | - |
|                                       |                         | 3/-  | -                   | ATV312HU30M3 T7             | ATV312HU30N4 T7    | -               | - |
|                                       |                         | 4/5  | -                   | ATV312HU40M3 T7             | ATV312HU40N4 T7    | ATV312HU40S6 T7 | - |
|                                       |                         | 5.5/7.5  | -                   | ATV312HU55M3 T8             | ATV312HU55N4 T8    | ATV312HU55S6 T8 | - |
|                                       |                         | 7.5/10   | -                   | ATV312HU75M3 T8             | ATV312HU75N4 T8    | ATV312HU75S6 T8 | - |
|                                       |                         | 11/15  | -                   | ATV312HD11M3 T9             | ATV312HD11N4 T9    | ATV312HD11S6 T9 | - |
|                                       |                         | 15/20  | -                   | ATV312HD15M3 T9             | ATV312HD15N4 T9    | ATV312HD15S6 T9 | - |

(1) C2 up to 4 kW

(2) Supplied with integrated C3 EMC filter

# Altivar 31C

0.18...15 kW

## Simple machines Enclosed IP55 drives



| Dimensions (in mm)  | width x height x depth |
|---|------------------------|
| <b>Size 1:</b> 210 x 240 x 163 / <b>Size 2:</b> 215 x 297 x 192 |                        |
| <b>Size 3:</b> 230 x 340 x 208 / <b>Size 4:</b> 320 x 512 x 282 |                        |
| <b>Size 5:</b> 440 x 625 x 282                                  |                        |

| Supply voltage       |       |           | Single-phase 200...240 V   |        | Three-phase 380...500 V |        |
|----------------------|-------|-----------|--|--------|-------------------------|--------|
| Degree of protection |       |           | IP55   |        |                         |        |
| Description          |       |           | Enclosure equipped with an Altivar 31 drive with external heatsink. Removable covers for adding 1 switch-disconnector or 1 circuit-breaker, 3 buttons and/or LEDs, 1 potentiometer |        |                         |        |
| Motor power          | kW/HP | 0.18/0.25 | ATV31C018M2  | Size 1 | -                       |        |
|                      |       | 0.37/0.5  | ATV31C037M2  | Size 1 | ATV31C037N4             | Size 2 |
|                      |       | 0.55/0.75 | ATV31C055M2  | Size 1 | ATV31C055N4             | Size 2 |
|                      |       | 0.75/1    | ATV31C075M2  | Size 1 | ATV31C075N4             | Size 2 |
|                      |       | 1.1/1.5   | ATV31CU11M2  | Size 2 | ATV31CU11N4             | Size 2 |
|                      |       | 1.5/2     | ATV31CU15M2  | Size 2 | ATV31CU15N4             | Size 2 |
|                      |       | 2.2/3     | ATV31CU22M2  | Size 3 | ATV31CU22N4             | Size 3 |
|                      |       | 3/-       | -  |        | ATV31CU30N4             | Size 3 |
|                      |       | 4/5       | -  |        | ATV31CU40N4             | Size 3 |
|                      |       | 5.5/7.5   | -  |        | ATV31CU55N4 (1)         | Size 4 |
|                      |       | 7.5/10    | -  |        | ATV31CU75N4 (1)         | Size 4 |
|                      |       | 11/15     | -  |        | ATV31CD11N4 (1)         | Size 5 |
|                      |       | 15/20     | -  |        | ATV31CD15N4 (1)         | Size 5 |

(1) Standard enclosed drive



| Dimensions (in mm) | width x height x depth                    |
|--------------------|---|
| T1:                | 45 x 317 x 245                            |
| T2:                | 60 x 317 x 245                            |
| T4:                | 150 x 308 x 232 (EMC plate installed)     |
| T4:                | 150 x 232 x 232 (EMC plate not installed) |
| T5:                | 180 x 404 x 232 (EMC plate installed)     |
| T5:                | 180 x 330 x 232 (EMC plate not installed) |

| Type of drive                  |  | Single-phase<br>240 V with integrated EMC filter  | Three-phase<br>500 V with integrated EMC filter                                 |                |
|--------------------------------|--|---|---|----------------|
| Degree of protection           |  | IP20  |   |                |
| Drive                          | Output frequency                       | 0.1...599 Hz  |   |                |
|                                | Type of control                        | Asynchronous motor  |   |                |
|                                |  | Synchronous motor   |   |                |
| Transient overtorque           | 170...200% of the nominal motor torque |   |   |                |
| Speed range                    |  | 1 to 50   |   |                |
| Functions                      | Number of functions                    |   | 150   |                |
|                                | Number of I/O                          | Analog inputs   | 3 - Response time : 3ms, resolution 10 bits                                     |                |
|                                |  | Logic inputs  | 6 - Response time : 8 ms, configurable in PTC and IN pwm                        |                |
|                                |  | Analog outputs  | 1 - Updating time : 2 ms  |                |
|                                |  | Logic outputs   | 1 - Sampling time : 2 ms, configurable as voltage (0-10 V) or current (0-20 mA) |                |
| Relay outputs                  |  | 2   |   |                |
| Dialogue                       |  | 4-digit display, remote display terminal (IP54 or IP55), remote graphic display terminal, SoMove setup software and SoMove Mobile application for mobile phone. |   |                |
| Communication                  | Integrated                             | Modbus and CANopen - Bluetooth® link  |   |                |
|                                | As an option                           | DeviceNet, PROFIBUS DP V1, EtherNet/IP, Modbus TCP, EtherCat  |   |                |
| Reduction of current harmonics |  |   |   |                |
| EMC filter                     | Integrated                             | C2 EMC  |   |                |
|                                | As an option                           | C1 EMC  |   |                |
| Motor power                    | kW                                     | HP  |   |                |
|                                | 0.18                                   | 1/4   | ATV32H018M2 T1  | –              |
|                                | 0.37                                   | 1/2   | ATV32H037M2 T1  | ATV32H037N4 T1 |
|                                | 0.55                                   | 3/4   | ATV32H055M2 T1  | ATV32H055N4 T1 |
|                                | 0.75                                   | 1   | ATV32H075M2 T1  | ATV32H075N4 T1 |
|                                | 1.1                                    | 1 1/2   | ATV32HU11M2 T2  | ATV32HU11N4 T1 |
|                                | 1.5                                    | 2   | ATV32HU15M2 T2  | ATV32HU15N4 T1 |
|                                | 2.2                                    | 3   | ATV32HU22M2 T2  | ATV32HU22N4 T2 |
|                                | 3                                      | –   | –   | ATV32HU30N4 T2 |
|                                | 4                                      | 5   | –   | ATV32HU40N4 T2 |
|                                | 5.5                                    | 7 1/2   | –   | ATV32HU55N4 T4 |
|                                | 7.5                                    | 10  | –   | ATV32HU75N4 T4 |
|                                | 11                                     | 15  | –   | ATV32HD11N4 T5 |
| 15                             | 20                                     | –   | ATV32HD15N4 T5  |                |



# Notes

3

| Dimensions (in mm) |                    | width x height x depth |                     |
|--------------------|--------------------|------------------------|---------------------|
| T2                 | : 130 x 230 x 175  | T3                     | : 155 x 260 x 187   |
| T4                 | : 175 x 295 x 187  | T5A                    | : 210 x 295 x 213   |
| T5B                | : 230 x 400 x 213  | T6                     | : 240 x 420 x 236   |
| T7A                | : 240 x 550 x 266  | T7B                    | : 320 x 550 x 266   |
| T8                 | : 320 x 630 x 290  | T9                     | : 320 x 920 x 377   |
| T10                | : 360 x 1022 x 377 | T11                    | : 340 x 1190 x 377  |
| T12                | : 440 x 1190 x 377 | T13                    | : 595 x 1190 x 377  |
| T14                | : 890 x 1390 x 377 | T15                    | : 1120 x 1390 x 377 |



| Type of drive                         |                         |                    | Single-phase   | Three-phase         | Three-phase   |     |             |     |
|---------------------------------------|-------------------------|--------------------|--|---------------------|---|-----|-------------|-----|
| Supply voltage                        |                         |                    | 200...240 V  | 200...240 V         | 380...480 V   |     |             |     |
| <b>Degree of protection</b>           |                         |                    | IP20 for unprotected drives and IP41 on the upper part   |                     |   |     |             |     |
| <b>Drive</b>                          | Output frequency        |                    | 0.1...599 Hz up to 37 kW; 0.1...500 Hz from 45 to 800 kW   |                     |   |     |             |     |
|                                       | Type of control         | Asynchronous motor | Kn <sup>2</sup> quadratic ratio, flux vector control with or without sensor, voltage/frequency ratio (2 or 5 points), energy saving ratio  |                     |   |     |             |     |
|                                       |                         | Synchronous motor  | Vector control without speed feedback  |                     |   |     |             |     |
|                                       | Transient overtorque    |                    | 120...130% of the nominal drive current for 60 seconds   |                     |   |     |             |     |
| <b>Speed range</b>                    |                         |                    | 1...100 in open loop mode  |                     |   |     |             |     |
| <b>Functions</b>                      | Number of functions     |                    | > 150  |                     |   |     |             |     |
|                                       | Number of preset speeds |                    | 16   |                     |   |     |             |     |
|                                       | Number of I/O           |                    | Analog inputs 2...4/Logic inputs 6...20  |                     |   |     |             |     |
|                                       |                         |                    | Analog outputs 1...3/Logic outputs 0...8   |                     |   |     |             |     |
|                                       |                         |                    | Relay outputs 2...4  |                     |   |     |             |     |
| <b>Dialogue</b>                       |                         |                    | Safety input 1   |                     |   |     |             |     |
| <b>Communication</b>                  |                         |                    | Remote graphic display terminal, SoMove setup software (3)   |                     |   |     |             |     |
| <b>Communication</b>                  |                         |                    | Modbus and CANopen   |                     |   |     |             |     |
| <b>Communication</b>                  |                         |                    | As an option   |                     |   |     |             |     |
| <b>Communication</b>                  |                         |                    | <b>HVAC protocols:</b> LonWorks, BACnet, METASYS N2, APOGEE FLN P1<br><b>Industrial protocols:</b> Modbus TCP Daisy Chain, Modbus/Uni-Telway, EtherNet/IP, EtherCAT, DeviceNet, PROFIBUS DP V0 and V1, INTERBUS, CC-Link |                     |   |     |             |     |
| <b>Cards (available as an option)</b> |                         |                    | Multi-pump cards, I/O extension cards, "Controller Inside" programmable card   |                     |   |     |             |     |
| <b>Reduction of current harmonics</b> |                         |                    | DC choke integrated or supplied with the drive or AFE Altivar (Active Front End)   |                     |   |     |             |     |
| <b>EMC filter</b>                     | Integrated              |                    | C2 EMC   | C2 EMC up to 7.5 kW | C2 EMC up to 4 kW                                       |     |             |     |
|                                       | As an option            |                    | C1 EMC   | C1 EMC              | C3 EMC from 5.5 to 630 kW<br>C1 EMC from 0.75 to 630 kW |     |             |     |
| <b>Motor power</b>                    | kW/HP                   | 0.37/0.5           | ATV61H075M3  | T2                  | –   | –   |             |     |
|                                       |                         | 0.75/1             | ATV61HU15M3  | T2                  | ATV61H075M3   | T2  | ATV61H075N4 | T2  |
|                                       |                         | 1.5/2              | ATV61HU22M3  | T3                  | ATV61HU15M3   | T2  | ATV61HU15N4 | T2  |
|                                       |                         | 2.2/3              | ATV61HU30M3  | T3                  | ATV61HU22M3   | T3  | ATV61HU22N4 | T2  |
|                                       |                         | 3/–                | ATV61HU40M3 (1)  | T3                  | ATV61HU30M3   | T3  | ATV61HU30N4 | T3  |
|                                       |                         | 4/5                | ATV61HU55M3 (1)  | T4                  | ATV61HU40M3   | T3  | ATV61HU40N4 | T3  |
|                                       |                         | 5.5/7.5            | ATV61HU75M3 (1)  | T5A                 | ATV61HU55M3   | T4  | ATV61HU55N4 | T4  |
|                                       |                         | 7.5/10             | –  | –                   | ATV61HU75M3   | T5A | ATV61HU75N4 | T4  |
|                                       |                         | 11/15              | –  | –                   | ATV61HD11M3X(2)   | T5B | ATV61HD11N4 | T5A |
|                                       |                         | 15/20              | –  | –                   | ATV61HD15M3X(2)   | T5B | ATV61HD15N4 | T5B |
|                                       |                         | 18.5/25            | –  | –                   | ATV61HD18M3X(2)   | T6  | ATV61HD18N4 | T5A |
|                                       |                         | 22/30              | –  | –                   | ATV61HD22M3X(2)   | T6  | ATV61HD22N4 | T6  |
|                                       |                         | 30/40              | –  | –                   | ATV61HD30M3X(2)   | T7B | ATV61HD30N4 | T7A |
|                                       |                         | 37/50              | –  | –                   | ATV61HD37M3X(2)   | T7B | ATV61HD37N4 | T7A |
|                                       |                         | 45/60              | –  | –                   | ATV61HD45M3X(2)   | T7B | ATV61HD45N4 | T8  |
|                                       |                         | 55/75              | –  | –                   | ATV61HD55M3X(2)   | T9  | ATV61HD55N4 | T8  |
|                                       |                         | 75/100             | –  | –                   | ATV61HD75M3X(2)   | T9  | ATV61HD75N4 | T8  |
|                                       |                         | 90/125             | –  | –                   | ATV61HD90M3X(2)   | T10 | ATV61HD90N4 | T9  |
|                                       |                         | 110/150            | –  | –                   | –   | –   | ATV61HC11N4 | T9  |
|                                       |                         | 132/200            | –  | –                   | –   | –   | ATV61HC13N4 | T10 |
|                                       |                         | 160/250            | –  | –                   | –   | –   | ATV61HC16N4 | T11 |
|                                       |                         | 220/350            | –  | –                   | –   | –   | ATV61HC22N4 | T12 |
|                                       |                         | 250/400            | –  | –                   | –   | –   | ATV61HC25N4 | T13 |
|                                       |                         | 315/500            | –  | –                   | –   | –   | ATV61HC31N4 | T13 |
|                                       |                         | 400/600            | –  | –                   | –   | –   | ATV61HC40N4 | T14 |
|                                       |                         | 500/700            | –  | –                   | –   | –   | ATV61HC50N4 | T14 |
|                                       |                         | 630/900            | –  | –                   | –   | –   | ATV61HC63N4 | T15 |

(1) Must be used with a line choke, refer to the Schneider Electric catalogue.

(2) Drive supplied without EMC filter

(3) SoMove setup software : available from 2011. Altivar 61 is also supported by Powersuite software workshop.

For all other variants, please refer to the Schneider Electric catalogue.



| Dimensions (in mm) | width x height x depth |
|--------------------|------------------------|
| <b>T6</b>          | : 240 x 420 x 236      |
| <b>T8</b>          | : 320 x 630 x 290      |
| <b>T11</b>         | : 340 x 1190 x 377     |
| <b>T13</b>         | : 595 x 1190 x 377     |
| <b>T15</b>         | : 1120 x 1390 x 377    |

| Type of drive                  |                         | Three-phase   |   |       |            |     |
|--------------------------------|-------------------------|---|---|-------|------------|-----|
| Supply voltage                 |                         | 500...690 V   |   |       |            |     |
| Degree of protection           |                         | IP20 and IP41 on the upper part   |   |       |            |     |
| Drive                          | Output frequency        | 0.1...599 Hz up to 37 kW; 0.1...500 Hz from 45 to 800 kW  |   |       |            |     |
|                                | Type of control         | Asynchronous motor  | Kn <sup>2</sup> quadratic ratio, flux vector control with or without sensor, voltage/frequency ratio (2 or 5 points), energy saving ratio |       |            |     |
|                                |                         | Synchronous motor   | Vector control without speed feedback   |       |            |     |
|                                | Transient overtorque    | 120...130% of the nominal drive current for 60 seconds  |   |       |            |     |
| Speed range                    |                         | 1...100 in open loop mode   |   |       |            |     |
| Functions                      | Number of functions     | > 150   |   |       |            |     |
|                                | Number of preset speeds | 16  |   |       |            |     |
|                                | Number of I/O           | Analog inputs 2...4/Logic inputs 6...20<br>Analog outputs 1...3/Logic outputs 0...8<br>Relay outputs 2...4<br>Safety input 1  |   |       |            |     |
| Dialogue                       |                         | Remote graphic display terminal, SoMove setup software (1)  |   |       |            |     |
| Communication                  | Integrated              | Modbus and CANopen  |   |       |            |     |
|                                | As an option            | <b>HVAC protocols:</b> LonWorks, BACnet, METASYS N2, APOGEE FLN P1<br><b>Industrial protocols:</b> Modbus TCP Daisy Chain, Modbus/Uni-Telway, EtherNet/IP, EtherCAT, DeviceNet, PROFIBUS DP V0 et V1, INTERBUS, CC-Link |   |       |            |     |
| Cards (available as an option) |                         | Multi-pump cards, I/O extension cards, "Controller Inside" programmable card  |   |       |            |     |
| Reduction of current harmonics |                         | DC choke integrated or supplied with the product or AFE Altivar (Active Front End)  |   |       |            |     |
| EMC filter                     |                         | Integrated  |   |       |            |     |
| Motor power                    | kW/HP                   | 500 V   | 575 V   | 690 V |            |     |
|                                |                         | kW  | HP  | kW    |            |     |
|                                |                         | 2.2   | 3   | 3     | ATV61HU30Y | T6  |
|                                |                         | 3   | —   | 4     | ATV61HU40Y | T6  |
|                                |                         | 4   | 5   | 5.5   | ATV61HU55Y | T6  |
|                                |                         | 5.5   | 7.5   | 7.5   | ATV61HU75Y | T6  |
|                                |                         | 7.5   | 10  | 11    | ATV61HD11Y | T6  |
|                                |                         | 11  | 15  | 15    | ATV61HD15Y | T6  |
|                                |                         | 15  | 20  | 18.5  | ATV61HD18Y | T6  |
|                                |                         | 18.5  | 25  | 22    | ATV61HD22Y | T6  |
|                                |                         | 22  | 30  | 30    | ATV61HD30Y | T6  |
|                                |                         | 30  | 40  | 37    | ATV61HD37Y | T8  |
|                                |                         | 37  | 50  | 45    | ATV61HD45Y | T8  |
|                                |                         | 45  | 60  | 55    | ATV61HD55Y | T8  |
|                                |                         | 55  | 75  | 75    | ATV61HD75Y | T8  |
|                                |                         | 75  | 100   | 90    | ATV61HD90Y | T8  |
|                                |                         | 90  | 125   | 110   | ATV61HC11Y | T11 |
|                                |                         | 110   | 150   | 132   | ATV61HC13Y | T11 |
|                                |                         | 132   | —   | 160   | ATV61HC16Y | T11 |
|                                |                         | 160   | 200   | 200   | ATV61HC20Y | T11 |
|                                |                         | 200   | 250   | 250   | ATV61HC25Y | T13 |
|                                |                         | 250   | 350   | 315   | ATV61HC31Y | T13 |
|                                |                         | 315   | 450   | 400   | ATV61HC40Y | T13 |
|                                |                         | 400   | 550   | 500   | ATV61HC50Y | T15 |
|                                |                         | 500   | 700   | 630   | ATV61HC63Y | T15 |
|                                |                         | 630   | 800   | 800   | ATV61HC80Y | T15 |

(1) SoMove setup software : available from 2011. Altivar 61 is also supported by Powersuite software workshop.

For all other variants, please refer to the Schneider Electric catalogue.



| Dimensions (in mm)           |                              | width x height x depth |  |
|------------------------------|------------------------------|------------------------|--|
| <b>ATV61W...</b>             |                              |                        |  |
| <b>TA2</b> : 235 x 490 x 272 | <b>TD</b> : 310 x 665 x 315  |                        |  |
| <b>TA3</b> : 235 x 490 x 286 | <b>TE</b> : 284 x 720 x 315  |                        |  |
| <b>TB</b> : 255 x 525 x 286  | <b>TF</b> : 284 x 880 x 343  |                        |  |
| <b>TC</b> : 290 x 560 x 315  | <b>TG</b> : 362 x 1000 x 364 |                        |  |

| Type of drive                         |                         | Three-phase 380...480 V  |   |     |                     |     |
|---------------------------------------|-------------------------|--|---|-----|---------------------|-----|
| <b>Degree of protection</b>           |                         | <b>Type 12 (1) / IP54</b>  |   |     |                     |     |
| <b>Drive</b>                          | Output frequency        | 0.1...599 Hz up to 37 kW; 0.1...500 Hz from 45 to 800 kW   |   |     |                     |     |
|                                       | Type of control         | Asynchronous motor   | Kn <sup>2</sup> quadratic ratio, flux vector control with or without sensor, voltage/frequency ratio (2 or 5 points), energy saving ratio |     |                     |     |
|                                       |                         | Synchronous motor  | Vector control without speed feedback   |     |                     |     |
|                                       | Transient overtorque    | 120...130% of the nominal drive current for 60 seconds   |   |     |                     |     |
| <b>Speed range</b>                    |                         | 1...100 in open loop mode  |   |     |                     |     |
| <b>Functions</b>                      | Number of functions     | > 150  |   |     |                     |     |
|                                       | Number of preset speeds | 16   |   |     |                     |     |
|                                       | Number of I/O           | Analog inputs 2...4/Logic inputs 6...20  |   |     |                     |     |
|                                       |                         | Analog outputs 1...3/Logic outputs 0...8   |   |     |                     |     |
| <b>Dialogue</b>                       |                         | Remote graphic display terminal, SoMove setup software (2)   |   |     |                     |     |
| <b>Communication</b>                  | Integrated              | Modbus and CANopen   |   |     |                     |     |
|                                       | As an option            | <b>HVAC protocols:</b> LonWorks, BACnet, METASYS N2, APOGEE FLN P1<br><b>Industrial protocols:</b> Modbus TCP Daisy Chain, Modbus/Uni-Telway, EtherNet/IP, EtherCAT, DeviceNet, PROFIBUS DP V0 and V1, INTERBUS, CC-Link |   |     |                     |     |
| <b>Cards (available as an option)</b> |                         | Multi-pump cards, I/O extension cards, "Controller Inside" programmable card   |   |     |                     |     |
| <b>Reduction of current harmonics</b> |                         | Integrated DC choke  |   |     |                     |     |
| <b>EMC filter</b>                     | Integrated              | C2 EMC   |   |     |                     |     |
|                                       | As an option            | -  |   |     |                     |     |
| <b>Motor power</b>                    | kW/HP                   | 0.75/1   | <b>ATV61W075N4</b>  | TA2 | <b>ATV61E5075N4</b> | TA2 |
|                                       |                         | 1.5/2  | <b>ATV61WU15N4</b>  | TA2 | <b>ATV61E5U15N4</b> | TA2 |
|                                       |                         | 2.2/3  | <b>ATV61WU22N4</b>  | TA2 | <b>ATV61E5U22N4</b> | TA2 |
|                                       |                         | 3/-  | <b>ATV61WU30N4</b>  | TA3 | <b>ATV61E5U30N4</b> | TA3 |
|                                       |                         | 4/5  | <b>ATV61WU40N4</b>  | TA3 | <b>ATV61E5U40N4</b> | TA3 |
|                                       |                         | 5.5/7.5  | <b>ATV61WU55N4</b>  | TB  | <b>ATV61E5U55N4</b> | TB  |
|                                       |                         | 7.5/10   | <b>ATV61WU75N4</b>  | TB  | <b>ATV61E5U75N4</b> | TB  |
|                                       |                         | 11/15  | <b>ATV61WD11N4</b>  | TC  | <b>ATV61E5D11N4</b> | TC  |
|                                       |                         | 15/20  | <b>ATV61WD15N4</b>  | TD  | <b>ATV61E5D15N4</b> | TD  |
|                                       |                         | 18.5/25  | <b>ATV61WD18N4</b>  | TD  | <b>ATV61E5D18N4</b> | TD  |
|                                       |                         | 22/30  | <b>ATV61WD22N4</b>  | TE  | <b>ATV61E5D22N4</b> | TE  |
|                                       |                         | 30/40  | <b>ATV61WD30N4</b>  | TF  | <b>ATV61E5D30N4</b> | TF  |
|                                       |                         | 37/50  | <b>ATV61WD37N4</b>  | TF  | <b>ATV61E5D37N4</b> | TF  |
|                                       |                         | 45/60  | <b>ATV61WD45N4</b>  | TG  | <b>ATV61E5D45N4</b> | TG  |
|                                       |                         | 55/75  | <b>ATV61WD55N4</b>  | TG  | <b>ATV61E5D55N4</b> | TG  |
|                                       |                         | 75/100   | <b>ATV61WD75N4</b>  | TG  | <b>ATV61E5D75N4</b> | TG  |
| 90/125                                | <b>ATV61WD90N4</b>      | TG   | <b>ATV61E5D90N4</b>   | TG  |                     |     |

Drive with integrated C1 filter: add the letter **C** at the end of the reference. For example, ATV61W075N4 becomes ATV61W075N4C

For other variants, please refer to the Schneider Electric catalogue.

(1) For ATV61W... range only.

(2) SoMove setup software : available from 2011. Altivar 61 is also supported by Powersuite software workshop.

# Altivar 61

0.37...800 kW

## Pumping and ventilation machines

### IP54 Altivar 61 kit with preassembled enclosure



| Drive       | Kit                                 |
|-------------|-------------------------------------|
| ATV61HC11N4 | VW3A9541                            |
| ATV61HC13N4 | VW3A9542                            |
| ATV61HC16N4 | VW3A9543                            |
| ATV61HC22N4 | VW3A9544                            |
| ATV61HC25N4 | VW3A9545                            |
| ATV61HC31N4 |                                     |
| ATV61HC25N4 | VW3A9546                            |
| ATV61HC31N4 |                                     |
| ATV61HC40N4 | VW3A9547                            |
| ATV61HC50N4 |                                     |
| ATV61HC63N4 | VW3A9548                            |
|             | VW3A7102 braking unit               |
|             | VW3A9549                            |
|             | Additional empty enclosure (600 mm) |
|             | VW3A9550                            |
|             | Additional empty enclosure (800 mm) |
|             | VW3A9551                            |

3



| Dimensions (in mm) | width x height x depth |
|--------------------|------------------------|
| T11                | : 330 x 950 x 377      |
| T13                | : 585 x 950 x 377      |
| T15                | : 1110 x 1150 x 377    |

| Type of drive                  |                         | Three-phase   | Three-phase   |     |   |
|--------------------------------|-------------------------|---|---|-----|---|
| Supply voltage                 |                         | 380...480 V   | 500...690 V   |     |   |
| Degree of protection           |                         | Sideways and front IP31 - Top IP20 - Bottom IP00  |   |     |   |
| Drive                          | Output frequency        | 0.1...500Hz   |   |     |   |
|                                | Type of control         | Asynchronous motor  | Kn <sup>2</sup> quadratic ratio, flux vector control with or without sensor, voltage/frequency ratio (2 or 5 points), energy saving ratio |     |   |
|                                |                         | Synchronous motor   | Vector control without speed feedback   |     |   |
|                                | Transient overtorque    | 120...130% of the nominal drive current for 60 seconds  |   |     |   |
| Speed range                    |                         | 1...100 in open loop mode   |   |     |   |
| Functions                      | Number of functions     | > 150   |   |     |   |
|                                | Number of preset speeds | 16  |   |     |   |
|                                | Number of I/O           | Analog inputs 2...4/Logic inputs 6...20<br>Analog outputs 1...3/Logic outputs 0...8<br>Relay outputs 2...4<br>Safety input 1  |   |     |   |
| Dialogue                       |                         | Remote graphic display terminal, SoMove setup software (2)  |   |     |   |
| Communication                  | Integrated              | Modbus and CANopen  |   |     |   |
|                                | As an option            | <b>HVAC protocols:</b> LonWorks, BACnet, METASYS N2, APOGEE FLN P1<br><b>Industrial protocols:</b> Modbus TCP, Modbus/Uni-Telway, Fipio, Modbus Plus, Profbus DP, Profbus DP V1, DeviceNet, EthernetIP, CC-Link, INTERBUS |   |     |   |
| Cards (available as an option) |                         | Multi-pump cards, I/O extension cards, "Controller Inside" programmable card  |   |     |   |
| Reduction of current harmonics |                         | Optional AC choke, Altivar AFE (Active Front End)   |   |     |   |
| EMC filter                     | Integrated              | C3 EMC  |   |     |   |
|                                | As an option            | C1 EMC  |   |     |   |
| Motor power                    | kW/HP                   | 110/150   | ATV61QC11N4   | T11 | - |
|                                |                         | 132/200   | ATV61QC13N4   | T11 | - |
|                                |                         | 160/250   | ATV61QC16N4   | T11 | - |
|                                |                         | 200/300   | ATV61QC20N4   | T13 | - |
|                                |                         | 250/400   | ATV61QC25N4   | T13 | - |
|                                |                         | 315/500   | ATV61QC31N4   | T13 | - |
|                                |                         | 400/600   | ATV61QC40N4   | T15 | - |
|                                |                         | 500/700   | ATV61QC50N4   | T15 | - |
| 630/900                        | ATV61QC63N4             | T15   | -   |     |   |

|  | 500 V | 575 V | 690 V |   |                |
|--|-------|-------|-------|---|----------------|
|  | kW    | HP    | kW    |   |                |
|  | 110   | 150   | 132   | - | ATV61QC13Y T11 |
|  | 132   | -     | 160   | - | ATV61QC16Y T11 |
|  | 160   | 200   | 200   | - | ATV61QC20Y T11 |
|  | 200   | 250   | 250   | - | ATV61QC25Y T13 |
|  | 250   | 350   | 315   | - | ATV61QC31Y T13 |
|  | 315   | 450   | 400   | - | ATV61QC40Y T13 |
|  | 400   | 550   | 500   | - | ATV61QC50Y T15 |
|  | 500   | 700   | 630   | - | ATV61QC63Y T15 |
|  | 630   | 800   | 800   | - | ATV61QC80Y T15 |

(1) SoMove setup software : available during 2011. Altivar 61 also works with the PowerSuite software workshop.

# Altivar 61 Plus

90...2400 kW

## Pumping and ventilation machines Solutions in IP23 and IP54 ready-assembled enclosures



| Dimensions (in mm)   | width x height x depth |
|----------------------|------------------------|
| <b>ATV61EXC2C...</b> |                        |
| <b>E1</b>            | : 600 x 2162 x 642     |
| <b>E2</b>            | : 800 x 2162 x 642     |
| <b>E3</b>            | : 1000 x 2162 x 642    |
| <b>E4</b>            | : 1200 x 2162 x 642    |

| Enclosure types                       |                         | Three-phase 380...480 V - 500 V - 690 V<br>(1)  |
|---------------------------------------|-------------------------|---|
| <b>Degree of protection</b>           |                         | <b>IP23, IP54</b>   |
| <b>Drive</b>                          | Output frequency        | 0.1...599 Hz up to 37 kW; 0.1...500 Hz from 45...2400 kW  |
|                                       | Type of control         | Asynchronous motor<br>K $\pi^2$ quadratic ratio, flux vector control with or without sensor, voltage/frequency ratio (2 or 5 points), energy saving ratio   |
|                                       |                         | Synchronous motor<br>Vector control without speed feedback  |
|                                       | Transient overtorque    | 120...130% of the nominal drive current for 60 seconds  |
| <b>Speed range</b>                    |                         | 1...100 in open loop mode   |
| <b>Functions</b>                      | Number of functions     | > 150   |
|                                       | Number of preset speeds | 16  |
|                                       | Number of I/O           | Analog inputs 2...4/Logic inputs 6...20   |
|                                       |                         | Analog outputs 1...3/Logic outputs 0...8  |
|                                       |                         | Relay outputs 2...4   |
| <b>Dialogue</b>                       |                         | Safety input 1  |
| <b>Communication</b>                  |                         | Remote graphic display terminal, SoMove setup software (2)  |
| <b>Communication</b>                  | Integrated              | Modbus and CANopen  |
|                                       | As an option            | <b>HVAC protocols:</b> LonWorks, BACnet, METASYS N2, APOGEE FLN P1<br><b>Industrial protocols:</b> Modbus TCP, Modbus/Uni-Telway, EtherNet/IP, EtherCAT, DeviceNet, PROFIBUS DP V0 and V1, INTERBUS, CC-Link.   |
| <b>Cards (available as an option)</b> |                         | Multi-pump cards, I/O extension cards, "Controller Inside" programmable card  |
| <b>Reduction of current harmonics</b> |                         | DC choke or Integrated AC choke, variant 12 pulse, AFE Altivar (Active Front End)   |
| <b>EMC filter</b>                     | Integrated              | C3 EMC  |
| <b>Equipment</b>                      |                         | A wide range of options listed in the catalogue provides add-ons for the standard offer as required.<br>As well as the options listed in the catalogue, it is possible to customise the equipment. Just contact our teams of experts directly.<br>- Water cooling solution<br>- Integration of specific options |

3



| IP23 | Three-phase 380...415 V |                |    | Three-phase 500 V |                |    | Three-phase 690 V |                |    |
|------|-------------------------|----------------|----|-------------------|----------------|----|-------------------|----------------|----|
|      | kW/HP                   | Dimensions     |    | kW                | Dimensions     |    | kW                | Dimensions     |    |
|      | 90/125                  | ATV61EXC2D90N4 | E1 | 90                | ATV61 EXC2D90N | E1 | -                 |                |    |
|      | 110/150                 | ATV61EXC2C11N4 | E1 | 110               | ATV61 EXC2C11N | E1 | 110               | ATV61 EXC2C11Y | E1 |
|      | 132/200                 | ATV61EXC2C13N4 | E1 | 132               | ATV61 EXC2C13N | E1 | 132               | ATV61 EXC2C13Y | E1 |
|      | 160/250                 | ATV61EXC2C16N4 | E1 | 160               | ATV61 EXC2C16N | E1 | 160               | ATV61 EXC2C16Y | E1 |
|      | 220/350                 | ATV61EXC2C22N4 | E1 | 200               | ATV61 EXC2C20N | E2 | 200               | ATV61 EXC2C20Y | E1 |
|      | 250/400                 | ATV61EXC2C25N4 | E2 | 250               | ATV61 EXC2C25N | E2 | 250               | ATV61 EXC2C25Y | E2 |
|      | 315/500                 | ATV61EXC2C31N4 | E2 | 315               | ATV61 EXC2C31N | E2 | 315               | ATV61 EXC2C31Y | E2 |
|      | 400/600                 | ATV61EXC2C40N4 | E3 | 400               | ATV61 EXC2C40N | E4 | 400               | ATV61 EXC2C40Y | E2 |
|      | 500/700                 | ATV61EXC2C50N4 | E3 | 500               | ATV61 EXC2C50N | E4 | 500               | ATV61 EXC2C50Y | E4 |
|      | 630/900                 | ATV61EXC2C63N4 | E4 | 630               | ATV61 EXC2C63N | E4 | 630               | ATV61 EXC2C63Y | E4 |
|      |                         |                |    |                   |                |    | 800               | ATV61 EXC2C80Y | E4 |

(1) The Altivar 61 range in ready-assembled enclosure consists of: an ATV61H... drive, a switch and fast-acting fuses, an IP65 remote mounting kit for graphic display terminal  
(2) SoMove setup software : available from 2011. Altivar 61 is also supported by Powersuite software workshop.

IP23 offer available up to 2400 kW. For ratings above 800 kW, please consult your Regional Sales Office.

| Dimensions (in mm)            |                                | width x height x depth |  |
|-------------------------------|--------------------------------|------------------------|--|
| <b>ATV61EX...</b>             |                                |                        |  |
| <b>E5</b> : 600 x 2262 x 642  | <b>E9</b> : 600 x 2362 x 642   |                        |  |
| <b>E6</b> : 800 x 2262 x 642  | <b>E10</b> : 800 x 2362 x 642  |                        |  |
| <b>E7</b> : 1000 x 2262 x 642 | <b>E11</b> : 1000 x 2362 x 642 |                        |  |
| <b>E8</b> : 1200 x 2262 x 642 | <b>E12</b> : 1200 x 2362 x 642 |                        |  |
|                               | <b>E13</b> : 1400 x 2362 x 642 |                        |  |
|                               | <b>E14</b> : 1600 x 2362 x 642 |                        |  |

| IP54 (1)                         | Three-phase 380...415 V |                |            |     | Three-phase 500 V |    |            |               | Three-phase 690 V |               |               |    |
|----------------------------------|-------------------------|----------------|------------|-----|-------------------|----|------------|---------------|-------------------|---------------|---------------|----|
|                                  | kW/HP                   |                | Dimensions |     | kW                |    | Dimensions |               | kW                |               | Dimensions    |    |
| Compact floor-standing enclosure | 90 / 125                | ATV61EXC5D90N4 | E5         | 90  | ATV61EXC5D90N     | E5 | 90         | ATV61EXC5D90N | E5                | –             | –             | –  |
|                                  | 110/150                 | ATV61EXC5C11N4 | E5         | 110 | ATV61EXC5C11N     | E5 | 110        | ATV61EXC5C11N | E5                | 110           | ATV61EXC5C11Y | E5 |
|                                  | 132/200                 | ATV61EXC5C13N4 | E5         | 132 | ATV61EXC5C13N     | E5 | 132        | ATV61EXC5C13N | E5                | 132           | ATV61EXC5C13Y | E5 |
|                                  | 160/250                 | ATV61EXC5C16N4 | E5         | 160 | ATV61EXC5C16N     | E5 | 160        | ATV61EXC5C16N | E5                | 160           | ATV61EXC5C16Y | E5 |
|                                  | 220/350                 | ATV61EXC5C22N4 | E5         | 200 | ATV61EXC5C20N     | E6 | 200        | ATV61EXC5C20N | E6                | 200           | ATV61EXC5C20Y | E5 |
|                                  | 250/400                 | ATV61EXC5C25N4 | E6         | 250 | ATV61EXC5C25N     | E6 | 250        | ATV61EXC5C25N | E6                | 250           | ATV61EXC5C25Y | E6 |
|                                  | 315/500                 | ATV61EXC5C31N4 | E6         | 315 | ATV61EXC5C31N     | E6 | 315        | ATV61EXC5C31N | E6                | 315           | ATV61EXC5C31Y | E6 |
|                                  | 400/600                 | ATV61EXC5C40N4 | E7         | 400 | ATV61EXC5C40N     | E8 | 400        | ATV61EXC5C40N | E8                | 400           | ATV61EXC5C40Y | E6 |
|                                  | 500/700                 | ATV61EXC5C50N4 | E7         | 500 | ATV61EXC5C50N     | E8 | 500        | ATV61EXC5C50N | E8                | 500           | ATV61EXC5C50Y | E8 |
|                                  | 630/900                 | ATV61EXC5C63N4 | E8         | 630 | ATV61EXC5C63N     | E8 | 630        | ATV61EXC5C63N | E8                | 630           | ATV61EXC5C63Y | E8 |
|                                  |                         |                |            |     |                   |    |            |               | 800               | ATV61EXC5C80Y | E8            |    |

(1) The IP54 offer is available for power ratings up to 800 kW. For higher power ratings up to 2400 kW, consult your customer care centre.

| IP54 (2)          | Three-phase 380...415 V |                |            |     | Three-phase 500 V |     |            |               | Three-phase 690 V |               |               |     |
|-------------------|-------------------------|----------------|------------|-----|-------------------|-----|------------|---------------|-------------------|---------------|---------------|-----|
|                   | kW/HP                   |                | Dimensions |     | kW                |     | Dimensions |               | kW                |               | Dimensions    |     |
| Separate air flow | 90 / 125                | ATV61EXS5D90N4 | E9         | 90  | ATV61EXS5D90N     | E11 | 90         | ATV61EXS5D90N | E11               | –             | –             | –   |
|                   | 110/150                 | ATV61EXS5C11N4 | E9         | 110 | ATV61EXS5C11N     | E11 | 110        | ATV61EXS5C11N | E11               | 110           | ATV61EXS5C11Y | E11 |
|                   | 132/200                 | ATV61EXS5C13N4 | E9         | 132 | ATV61EXS5C13N     | E11 | 132        | ATV61EXS5C13N | E11               | 132           | ATV61EXS5C13Y | E11 |
|                   | 160/250                 | ATV61EXS5C16N4 | E9         | 160 | ATV61EXS5C16N     | E11 | 160        | ATV61EXS5C16N | E11               | 160           | ATV61EXS5C16Y | E11 |
|                   | 220/350                 | ATV61EXS5C22N4 | E9         | 200 | ATV61EXS5C20N     | E12 | 200        | ATV61EXS5C20N | E12               | 200           | ATV61EXS5C20Y | E11 |
|                   | 250/400                 | ATV61EXS5C25N4 | E10        | 250 | ATV61EXS5C25N     | E12 | 250        | ATV61EXS5C25N | E12               | 250           | ATV61EXS5C25Y | E12 |
|                   | 315/500                 | ATV61EXS5C31N4 | E10        | 315 | ATV61EXS5C31N     | E12 | 315        | ATV61EXS5C31N | E12               | 315           | ATV61EXS5C31Y | E12 |
|                   | 400/600                 | ATV61EXS5C40N4 | E13        | 400 | ATV61EXS5C40N     | E14 | 400        | ATV61EXS5C40N | E14               | 400           | ATV61EXS5C40Y | E12 |
|                   | 500/700                 | ATV61EXS5C50N4 | E13        | 500 | ATV61EXS5C50N     | E14 | 500        | ATV61EXS5C50N | E14               | 500           | ATV61EXS5C50Y | E14 |
|                   | 630/900                 | ATV61EXS5C63N4 | E14        | 630 | ATV61EXS5C63N     | E14 | 630        | ATV61EXS5C63N | E14               | 630           | ATV61EXS5C63Y | E14 |
|                   |                         |                |            |     |                   |     |            |               | 800               | ATV61EXS5C80Y | E14           |     |

(2) The IP54 offer with separate air flow is available for power ratings up to 800 kW. For higher power ratings up to 2400 kW, consult your customer care centre.



# Altivar 61 Plus-LH

55...630 kW

## Pumping and ventilation machines

Low harmonic solution in IP23 and IP54 enclosures

| Dimensions (in mm)     |                     | width x height x depth |                     |
|------------------------|---------------------|------------------------|---------------------|
| <b>ATV61EX●●●●●N4H</b> |                     |                        |                     |
| <b>E1</b>              | : 400 x 2157 x 642  | <b>E8</b>              | : 400 x 2237 x 642  |
| <b>E2</b>              | : 600 x 2157 x 642  | <b>E9</b>              | : 600 x 2237 x 642  |
| <b>E3</b>              | : 800 x 2157 x 642  | <b>E10</b>             | : 800 x 2237 x 642  |
| <b>E4</b>              | : 1200 x 2157 x 642 | <b>E11</b>             | : 1200 x 2237 x 642 |
| <b>E5</b>              | : 1600 x 2157 x 642 | <b>E12</b>             | : 1600 x 2237 x 642 |
| <b>E6</b>              | : 2000 x 2157 x 642 | <b>E13</b>             | : 2000 x 2237 x 642 |
| <b>E7</b>              | : 2400 x 2157 x 642 | <b>E14</b>             | : 2400 x 2237 x 642 |



| Enclosure types                       |                         |                    | Three-phase 380...480 V<br>(1)   |                 |                 |     |
|---------------------------------------|-------------------------|--------------------|--|-----------------|-----------------|-----|
| <b>Degree of protection</b>           |                         |                    | <b>IP23, IP54</b>  |                 |                 |     |
| <b>Drive</b>                          | Output frequency        |                    | 0.1...500 Hz   |                 |                 |     |
|                                       | Type of control         | Asynchronous motor | K <sup>n</sup> quadratic ratio, flux vector control with or without sensor, voltage/frequency ratio (2 or 5 points), energy saving ratio |                 |                 |     |
|                                       |                         | Synchronous motor  | Vector control without speed feedback  |                 |                 |     |
|                                       | Overload                |                    | 120% for 60 seconds per 10minutes  |                 |                 |     |
| <b>Speed range</b>                    |                         |                    | 1...100 in open loop mode  |                 |                 |     |
| <b>Functions</b>                      | Number of functions     |                    | > 150  |                 |                 |     |
|                                       | Number of preset speeds |                    | 16   |                 |                 |     |
|                                       | Number of I/O           |                    | Analog inputs 2...4/Logic inputs 6...20  |                 |                 |     |
|                                       |                         |                    | Analog outputs 1...3/Logic outputs 0...8   |                 |                 |     |
|                                       |                         |                    | Relay outputs 2...4  |                 |                 |     |
| <b>Dialogue</b>                       |                         |                    | Safety input 1   |                 |                 |     |
| <b>Communication</b>                  | Integrated              |                    | Remote graphic display terminal, SoMove setup software (2)   |                 |                 |     |
|                                       | As an option            |                    | Modbus and CANopen   |                 |                 |     |
| <b>Cards (available as an option)</b> |                         |                    | <b>HVAC protocols:</b> LonWorks, BACnet, METASYS N2, APOGEE FLN P1   |                 |                 |     |
| <b>EMC filter</b>                     |                         |                    | <b>Industrial protocols:</b> Modbus TCP, Modbus/Uni-Telway, EtherNet/IP, EtherCAT, DeviceNet, PROFIBUS DP V0 and V1, INTERBUS, CC-Link.  |                 |                 |     |
| <b>Equipment</b>                      |                         |                    | Multi-pump cards, I/O extension cards, "Controller Inside" programmable card   |                 |                 |     |
| <b>Motorpower</b>                     |                         |                    | C3 EMC   |                 |                 |     |
| kW                                    | 55                      |                    | A wide range of options listed in the catalogue provides add-ons for the standard offer as required.                                     |                 |                 |     |
|                                       | 75                      |                    | As well as the options listed in the catalogue, it is possible to customise the equipment. Just contact our teams of experts directly.   |                 |                 |     |
|                                       | 90                      |                    | - Integration of specific options  |                 |                 |     |
|                                       | 110                     |                    | ATV61EXC2D55N4H  | E1              | ATV61EXC5D55N4H | E8  |
|                                       | 132                     |                    | ATV61EXC2D75N4H  | E2              | ATV61EXC5D75N4H | E9  |
|                                       | 160                     |                    | ATV61EXC2D90N4H  | E2              | ATV61EXC5D90N4H | E9  |
|                                       | 220                     |                    | ATV61EXC2C11N4H  | E2              | ATV61EXC5C11N4H | E9  |
|                                       | 250                     |                    | ATV61EXC2C13N4H  | E3              | ATV61EXC5C13N4H | E10 |
|                                       | 315                     |                    | ATV61EXC2C16N4H  | E3              | ATV61EXC5C16N4H | E10 |
|                                       | 400                     |                    | ATV61EXC2C22N4H  | E4              | ATV61EXC5C22N4H | E11 |
|                                       | 500                     |                    | ATV61EXC2C25N4H  | E5              | ATV61EXC5C25N4H | E12 |
|                                       | 630                     |                    | ATV61EXC2C31N4H  | E5              | ATV61EXC5C31N4H | E12 |
|                                       |                         |                    | ATV61EXC2C40N4H  | E6              | ATV61EXC5C40N4H | E13 |
|                                       |                         |                    | ATV61EXC2C50N4H  | E6              | ATV61EXC5C50N4H | E13 |
|                                       |                         | ATV61EXC2C63N4H    | E7   | ATV61EXC5C63N4H | E14             |     |

(1) The Altivar 61 range in a ready-assembled enclosure consists of: an ATV61H...drive, an active in feed converter, a clean power filter, a switch and fast-acting fuses, an IP65 remote mounting kit for graphic display terminal.

(2) SoMove setup software : available from 2011. Altivar 61 is also supported by Powersuite software workshop.



| Type of card       | I/O extension Logic  | Extended   |
|--------------------|--|--|
| <b>Description</b> | 1 relay logic output ("C/O" contact)<br>4 x 24 VDC positive or negative logic inputs<br>2 x 24 VDC open collector positive or negative logic outputs<br>1 input for PTC probes | 1 x 0...20 mA differential current analog input<br>1 software-configurable voltage (0...10 VDC) or current (0...20 mA) analog input<br>2 software-configurable voltage ( $\pm 10V$ , 0...10 VDC) or current (0...20 mA) analog inputs<br>1 relay logic output ("C/O" contact)<br>4 x 24 VDC positive or negative logic inputs<br>2 x 24 VDC open collector positive or negative logic outputs<br>1 input for PTC probes<br>1 frequency control input |
| <b>Reference</b>   | <b>VW3A3201</b>  | <b>VW3A3202</b>  |

### "Controller Inside" programmable card



| Type of card       | Programmable "Controller Inside"  |
|--------------------|---|
| <b>Description</b> | 10 logic inputs, 2 of which can be used for 2 counters or 4 of which can be used for 2 incremental encoders<br>2 analog inputs, 6 logic outputs, 2 analog outputs, a master port for the CANopen bus, a PC port for programming with the PS 1131 software workshop. |
| <b>Reference</b>   | <b>VW3A3501</b>   |

### Multi-pump cards



| Type of card       | Multi-pump  |
|--------------------|---|
| <b>Description</b> | The pump switching card ensures compatibility of applications developed on the Altivar 38.<br>This card is specific to pump switching. It ensures optimum flow for an impeccable quality of service. Its algorithm both saves energy and prolongs equipment service life. |
| <b>Reference</b>   | <b>VW3A3502</b>   |
| <b>Description</b> | The VWA3503 "Water Solution" card can be used to support all multi-pump applications.<br>This card offers all the functions needed to manage a pumping, booster, irrigation station, etc with the operational safety of a control and monitoring system.                  |
| <b>Reference</b>   | <b>VW3A3503</b>   |

# Accessories and options

## Braking resistors



The network braking unit can be used to restore the following to the line supply:

- The energy from the motor
- The energy from the motors controlled by several drives connected on the same DC bus

| Type of drive<br>Supply voltage                                       | Three-phase          |                      |
|---|----------------------|----------------------|
|   | 200...240 V 50/60 Hz | 380...480 V 50/60 Hz |
| ATV61H075M3   | VW3A7701             | –                    |
| ATV61HU15M3, HU22M3   | VW3A7702             | –                    |
| ATV61HU30M3, HU40M3   | VW3A7703             | –                    |
| ATV61HU55M3, HU75M3   | VW3A7704             | –                    |
| ATV61HD11M3X  | VW3A7705             | –                    |
| ATV61HD15M3X  | VW3A7706             | –                    |
| ATV61HD18M3X, HD22M3X   | VW3A7707             | –                    |
| ATV61HD30M3X  | VW3A7708             | –                    |
| ATV61HD37M3X, HD45M3X   | VW3A7709             | –                    |
| ATV61HD55M3X, HD75M3X   | VW3A7713             | –                    |
| ATV61HD90M3X  | VW3A7714             | –                    |
| ATV61H075N4...HU40N4, ATV61W075N4...WU55N4,<br>ATV61W075N4C...WU55N4C | –                    | VW3A7701             |
| ATV61HU55N4, HU75N4, ATV61WU75N4, WD11N4,<br>ATV61WU75N4C, WD11N4C    | –                    | VW3A7702             |
| ATV61HD11N4, HD15N4, ATV61WD15N4, WD18N4,<br>ATV61WD15N4C, WD18N4C    | –                    | VW3A7703             |
| ATV61HD18N4...HD30N4, ATV61WD22N4...WD37N4,<br>ATV61WD22N4C...WD37N4C | –                    | VW3A7704             |
| ATV61HD37N4, ATV61WD45N4, WD45N4C                                     | –                    | VW3A7705             |
| ATV61WD55N4...WD90N4, ATV61WD55N4C...WD90N4C                          | –                    | VW3A7706             |
| ATV61HD45N4...HD75N4  | –                    | VW3A7707             |
| ATV61HD90N4, HC11N4   | –                    | VW3A7710             |
| ATV61HC13N4, HC16N4, E5C16N4  | –                    | VW3A7711             |
| ATV61HC22N4   | –                    | VW3A7712             |
| ATV61HC25N4   | –                    | VW3A7715             |
| ATV61HC31N4   | –                    | VW3A7716             |
| ATV61HC40N4, HC50N4, E5C50N4  | –                    | VW3A7717             |
| ATV61HC63N4   | –                    | VW3A7718             |

### Other accessories (see references in the Schneider Electric Catalogue)

- > Resistance braking units (integrated in ATV61 drives up to 220 kW)
- > Additional EMC input filters
- > AC line chokes
- > Optional DC chokes
- > Passive filters
- > Sinus filters
- > Motor chokes
- > Altivar AFE (Active Front End)
- > Regenerative network braking unit

# Altivar 71

0.37...630 kW

## Complex, high-power machines High performance drives

| Dimensions (in mm) |                    | width x height x depth         |
|--------------------|--------------------|--------------------------------|
| <b>T2</b>          | : 130 x 230 x 175  | <b>T3</b> : 155 x 260 x 187    |
| <b>T4</b>          | : 175 x 295 x 187  | <b>T5A</b> : 210 x 295 x 213   |
| <b>T5B</b>         | : 230 x 400 x 213  | <b>T6</b> : 240 x 420 x 236    |
| <b>T7A</b>         | : 240 x 550 x 266  | <b>T7B</b> : 320 x 550 x 266   |
| <b>T8</b>          | : 320 x 630 x 290  | <b>T9</b> : 320 x 920 x 377    |
| <b>T10</b>         | : 360 x 1022 x 377 | <b>T11</b> : 340 x 1190 x 377  |
| <b>T12</b>         | : 440 x 1190 x 377 | <b>T13</b> : 595 x 1190 x 377  |
| <b>T14</b>         | : 890 x 1390 x 377 | <b>T15</b> : 1120 x 1390 x 377 |



| Type of drive                  |   | Single-phase   | Three-phase   | Three-phase     |                  |     |             |     |
|--------------------------------|---|--|---|-----------------|------------------|-----|-------------|-----|
| Supply voltage                 |   | 200...240 V (3)  | 200...240 V (3)   | 380...480 V (3) |                  |     |             |     |
| Degree of protection           |   | IP20 for unprotected drives and IP41 on the upper part   |   |                 |                  |     |             |     |
| Drive                          | Output frequency  | 0...599 Hz up to 37 kW - 0...500 Hz from 45...630 kW   |   |                 |                  |     |             |     |
|                                | Type of control   | Asynchronous motor   | Flux vector control with or without sensor, voltage/frequency ratio (2 or 5 points), ENA System |                 |                  |     |             |     |
|                                |   | Synchronous motor  | Vector control with and without speed feedback (4)  |                 |                  |     |             |     |
|                                | Transient overtorque  | 220% of nominal motor torque for 2 seconds, and 170% for 60 seconds  |   |                 |                  |     |             |     |
| Speed range                    | 1...1000 in closed loop mode with encoder feedback, 1...100 in open loop mode       |  |   |                 |                  |     |             |     |
| Functions                      | Number of functions   | > 150  |   |                 |                  |     |             |     |
|                                | Number of preset speeds   | 16   |   |                 |                  |     |             |     |
|                                | Number of I/O   | Analog inputs  | 2...4   |                 |                  |     |             |     |
|                                |   | Logic inputs   | 6...20  |                 |                  |     |             |     |
|                                | Analog outputs  | 1...3  |   |                 |                  |     |             |     |
|                                | Logic outputs   | 0...8  |   |                 |                  |     |             |     |
|                                | Relay outputs   | 2...4  |   |                 |                  |     |             |     |
| Safety input                   | 1   |  |   |                 |                  |     |             |     |
| Dialogue                       | Remote graphic display terminal, SoMove setup software (5)                          |  |   |                 |                  |     |             |     |
| Communication                  | Integrated  | Modbus and CANopen   |   |                 |                  |     |             |     |
|                                | As an option  | Modbus TCP, Modbus/Uni-Telway, EtherNet/IP, EtherCAT, DeviceNet, PROFIBUS DP V0 and V1, INTERBUS, CC-Link. |   |                 |                  |     |             |     |
| Cards (available as an option) | Encoder interface cards, I/O extension cards, "Controller Inside" programmable card |  |   |                 |                  |     |             |     |
| Reduction of current harmonics | DC choke integrated or supplied with the product or Altivar AFE (Active Front End). |  |   |                 |                  |     |             |     |
| EMC filter                     | Integrated  | C2 EMC up to 4 kW, C3 EMC from 5,5 to 500 kW   |   |                 |                  |     |             |     |
|                                | As an option  | C1 EMC from 0.75 to 500 kW   |   |                 |                  |     |             |     |
| Motor power                    | kW/HP   | 0.37/0.5   | ATV71H075M3   | T2              | ATV71H037M3      | T2  | –           |     |
|                                |   | 0.75/1   | ATV71HU15M3   | T2              | ATV71H075M3      | T2  | ATV71H075N4 | T2  |
|                                |   | 1.5/2  | ATV71HU22M3   | T3              | ATV71HU15M3      | T2  | ATV71HU15N4 | T2  |
|                                |   | 2.2/3  | ATV71HU30M3   | T3              | ATV71HU22M3      | T3  | ATV71HU22N4 | T2  |
|                                |   | 3/–  | ATV71HU40M3 (1)   | T3              | ATV71HU30M3      | T3  | ATV71HU30N4 | T3  |
|                                |   | 4/5  | ATV71HU55M3 (1)   | T4              | ATV71HU40M3      | T3  | ATV71HU40N4 | T3  |
|                                |   | 5.5/7.5  | ATV71HU75M3 (1)   | T5A             | ATV71HU55M3      | T4  | ATV71HU55N4 | T4  |
|                                |   | 7.5/10   | –   | –               | ATV71HU75M3      | T5A | ATV71HU75N4 | T4  |
|                                |   | 11/15  | –   | –               | ATV71HD11M3X (2) | T5B | ATV71HD11N4 | T5A |
|                                |   | 15/20  | –   | –               | ATV71HD15M3X (2) | T5B | ATV71HD15N4 | T5B |
|                                |   | 18.5/25  | –   | –               | ATV71HD18M3X (2) | T6  | ATV71HD18N4 | T5B |
|                                |   | 22/30  | –   | –               | ATV71HD22M3X (2) | T6  | ATV71HD22N4 | T6  |
|                                |   | 30/40  | –   | –               | ATV71HD30M3X (2) | T7B | ATV71HD30N4 | T7A |
|                                |   | 37/50  | –   | –               | ATV71HD37M3X (2) | T7B | ATV71HD37N4 | T7A |
|                                |   | 45/60  | –   | –               | ATV71HD45M3X (2) | T7B | ATV71HD45N4 | T8  |
|                                |   | 55/75  | –   | –               | ATV71HD55M3X (2) | T9  | ATV71HD55N4 | T8  |
|                                |   | 75/100   | –   | –               | ATV71HD75M3X (2) | T10 | ATV71HD75N4 | T8  |
|                                |   | 90/125   | –   | –               | –                | –   | ATV71HD90N4 | T9  |
|                                |   | 110/150  | –   | –               | –                | –   | ATV71HC11N4 | T10 |
|                                |   | 132/200  | –   | –               | –                | –   | ATV71HC13N4 | T11 |
|                                |   | 160/250  | –   | –               | –                | –   | ATV71HC16N4 | T12 |
|                                |   | 200/300  | –   | –               | –                | –   | ATV71HC20N4 | T13 |
|                                |   | 220/350  | –   | –               | –                | –   | ATV71HC25N4 | T13 |
|                                |   | 280/450  | –   | –               | –                | –   | ATV71HC28N4 | T13 |
|                                |   | 315/500  | –   | –               | –                | –   | ATV71HC31N4 | T14 |
|                                |   | 355/–  | –   | –               | –                | –   | ATV71HC40N4 | T14 |
|                                |   | 500/700  | –   | –               | –                | –   | ATV71HC50N4 | T15 |

(1) Must be used with a line choke, Refer to the Schneider Electric catalogue.

(2) Drive supplied without EMC filter.

(3) A three-phase 380...480 V range on base plate is available from 0.75 to 11 kW. Please refer to the Schneider Electric catalogue.

(4) Vector control with speed feedback for synchronous motors is supported by the S383 variant of the Altivar 71.

(5) SoMove setup software : available from 2011. Altivar 71 is also supported by Powersuite software workshop.

# Altivar 71

0.37...630 kW

## Complex, high-power machines High performance drives



| Dimensions (in mm) |                    | width x height x depth         |
|--------------------|--------------------|--------------------------------|
| <b>T2</b>          | : 130 x 230 x 175  | <b>T3</b> : 155 x 260 x 187    |
| <b>T4</b>          | : 175 x 295 x 187  | <b>T5A</b> : 210 x 295 x 213   |
| <b>T5B</b>         | : 230 x 400 x 213  | <b>T6</b> : 240 x 420 x 236    |
| <b>T7A</b>         | : 240 x 550 x 266  | <b>T7B</b> : 320 x 550 x 266   |
| <b>T8</b>          | : 320 x 630 x 290  | <b>T9</b> : 320 x 920 x 377    |
| <b>T10</b>         | : 360 x 1022 x 377 | <b>T11</b> : 340 x 1190 x 377  |
| <b>T12</b>         | : 440 x 1190 x 377 | <b>T13</b> : 595 x 1190 x 377  |
| <b>T14</b>         | : 890 x 1390 x 377 | <b>T15</b> : 1120 x 1390 x 377 |

| Type of drive                  |                         | Three-phase   |  |        |            |     |
|--------------------------------|-------------------------|---|--|--------|------------|-----|
| Supply voltage                 |                         | 500... 690 V  |  |        |            |     |
| Degree of protection           |                         | IP20 for unprotected drives and IP41 on the upper part                              |  |        |            |     |
| Drive                          | Output frequency        | 0...599 Hz up to 37 kW - 0...500 Hz from 45...630 kW                                |  |        |            |     |
|                                | Type of control         | Asynchronous motor  | Flux vector control with or without sensor, voltage/frequency ratio (2 or 5 points), ENA System            |        |            |     |
|                                |                         | Synchronous motor   | Vector control with and without speed feedback (1)   |        |            |     |
|                                | Transient overtorque    | 220% of nominal motor torque for 2 seconds, and 170% for 60 seconds                 |  |        |            |     |
| Speed range                    |                         | 1...1000 in closed loop mode with encoder feedback, 1...100 in open loop mode       |  |        |            |     |
| Functions                      | Number of functions     |   | > 150  |        |            |     |
|                                | Number of preset speeds |   | 16   |        |            |     |
|                                | Number of I/O           | Analog inputs   |  | 2...4  |            |     |
|                                |                         | Logic inputs  |  | 6...20 |            |     |
|                                |                         | Analog outputs  |  | 1...3  |            |     |
|                                |                         | Logic outputs   |  | 0...8  |            |     |
|                                |                         | Relay outputs   |  | 2...4  |            |     |
| Safety input                   |                         | 1   |  |        |            |     |
| Dialogue                       |                         | Remote graphic display terminal, SoMove setup software (2)                          |  |        |            |     |
| Communication                  | Integrated              |   | Modbus and CANopen   |        |            |     |
|                                | As an option            |   | Modbus TCP, Modbus/Uni-Telway, EtherNet/IP, EtherCAT, DeviceNet, PROFIBUS DP V0 and V1, INTERBUS, CC-Link. |        |            |     |
| Cards (available as an option) |                         | Encoder interface cards, I/O extension cards, "Controller Inside" programmable card |  |        |            |     |
| Reduction of current harmonics |                         | DC choke integrated or DC choke optional or AFE Altivar (Active Front End)          |  |        |            |     |
| EMC filter                     |                         | Integrated  |  |        |            |     |
| Motor power                    | kW/HP                   | 500 V   | 575 V  | 690 V  |            |     |
|                                |                         | kW  | HP   | kW     |            |     |
|                                |                         | 1.5   | 2  | 2.2    | ATV71HU22Y | T6  |
|                                |                         | 2.2   | 3  | 3      | ATV71HU30Y | T6  |
|                                |                         | 3   | -  | 4      | ATV71HU40Y | T6  |
|                                |                         | 4   | 5  | 5.5    | ATV71HU55Y | T6  |
|                                |                         | 5.5   | 7.5  | 7.5    | ATV71HU75Y | T6  |
|                                |                         | 7.5   | 10   | 11     | ATV71HD11Y | T6  |
|                                |                         | 11  | 15   | 15     | ATV71HD15Y | T6  |
|                                |                         | 15  | 20   | 18.5   | ATV71HD18Y | T6  |
|                                |                         | 18.5  | 25   | 22     | ATV71HD22Y | T6  |
|                                |                         | 22  | 30   | 30     | ATV71HD30Y | T6  |
|                                |                         | 30  | 40   | 37     | ATV71HD37Y | T8  |
|                                |                         | 37  | 50   | 45     | ATV71HD45Y | T8  |
|                                |                         | 45  | 60   | 55     | ATV71HD55Y | T8  |
|                                |                         | 55  | 75   | 75     | ATV71HD75Y | T8  |
|                                |                         | 75  | 100  | 90     | ATV71HD90Y | T8  |
|                                |                         | 90  | 125  | 110    | ATV71HC11Y | T11 |
|                                |                         | 110   | 150  | 132    | ATV71HC13Y | T11 |
|                                |                         | 132   | -  | 160    | ATV71HC16Y | T11 |
|                                |                         | 160   | 200  | 200    | ATV71HC20Y | T13 |
|                                |                         | 200   | 250  | 250    | ATV71HC25Y | T13 |
|                                |                         | 250   | 350  | 315    | ATV71HC31Y | T13 |
|                                |                         | 315   | 450  | 400    | ATV71HC40Y | T15 |
|                                |                         | 400   | 550  | 500    | ATV71HC50Y | T15 |
|                                |                         | 500   | 700  | 630    | ATV71HC63Y | T15 |

(1) Vector control with speed feedback for synchronous motors is supported by the S383 variant of the Altivar 71.

(2) SoMove setup software : available from 2011. Altivar 71 is also supported by Powersuite software workshop..

For all other variants, please refer to the Schneider Electric catalogue.

# Altivar 71

0.75...75 kW

## Complex, high-power machines IP54 drives



| Dimensions (in mm)                   |                   | width x height x depth |
|--------------------------------------|-------------------|------------------------|
| ATV71W..., ATV71E5...<br>up to 75 kW |                   |                        |
| TA2                                  | : 235 x 490 x 272 | TD : 310 x 665 x 315   |
| TA3                                  | : 235 x 490 x 286 | TE : 284 x 720 x 315   |
| TB                                   | : 255 x 525 x 286 | TF : 284 x 880 x 343   |
| TC                                   | : 290 x 560 x 315 | TG : 362 x 1000 x 364  |

| Type of drive                         |                         | Three-phase 380...480 V   |   |     |              |     |
|---------------------------------------|-------------------------|---|---|-----|--------------|-----|
|                                       |                         |   |   |     | With switch  |     |
| <b>Degree of protection</b>           |                         | UL Type 12 (1) / IP54   |   |     |              |     |
| <b>Drive</b>                          | Output frequency        | 0...599 Hz up to 37 kW - 0...500 Hz from 45...75 kW   |   |     |              |     |
|                                       | Type of control         | Asynchronous motor  | Flux vector control with or without sensor, voltage/frequency ratio (2 or 5 points), ENA System |     |              |     |
|                                       |                         | Synchronous motor   | Vector control without speed feedback   |     |              |     |
| Transient overtorque                  |                         | 220% of nominal motor torque for 2 seconds, and 170% for 60 seconds                                       |   |     |              |     |
| <b>Speed range</b>                    |                         | 1...1000 in closed loop mode with encoder feedback, 1...100 in open loop mode                             |   |     |              |     |
| <b>Functions</b>                      | Number of functions     |   | > 150   |     |              |     |
|                                       | Number of preset speeds |   | 16  |     |              |     |
|                                       | Number of I/O           | Analog inputs   | 2...4   |     |              |     |
|                                       |                         | Logic inputs  | 6...20  |     |              |     |
|                                       |                         | Analog outputs  | 1...3   |     |              |     |
|                                       |                         | Logic outputs   | 0...8   |     |              |     |
|                                       |                         | Relay outputs   | 2...4   |     |              |     |
| Safety input                          |                         | 1   |   |     |              |     |
| <b>Dialogue</b>                       |                         | Remote graphic display terminal, SoMove setup software (2)  |   |     |              |     |
| <b>Communication</b>                  | Integrated              | Modbus and CANopen  |   |     |              |     |
|                                       | As an option            | Modbus TCP, Modbus/Uni-Telway, EtherNet/IP, EtherCAT, DeviceNet, PROFIBUS DP V0 et V1, INTERBUS, CC-Link. |   |     |              |     |
| <b>Cards (available as an option)</b> |                         | Encoder interface cards, I/O extension cards, "Controller Inside" programmable card                       |   |     |              |     |
| <b>Reduction of current harmonics</b> |                         | Optional chokes and passive filters   |   |     |              |     |
| <b>EMC filter</b>                     | Integrated              | C2 EMC  |   |     |              |     |
|                                       | As an option            | External C1 EMC   |   |     |              |     |
| <b>Motor power</b>                    | kW/HP                   | 0.75/1  | ATV71W075N4   | TA2 | ATV71E5075N4 | TA2 |
|                                       |                         | 1.5/2   | ATV71WU15N4   | TA2 | ATV71E5U15N4 | TA2 |
|                                       |                         | 2.2/3   | ATV71WU22N4   | TA2 | ATV71E5U22N4 | TA2 |
|                                       |                         | 3/-   | ATV71WU30N4   | TA3 | ATV71E5U30N4 | TA3 |
|                                       |                         | 4/5   | ATV71WU40N4   | TA3 | ATV71E5U40N4 | TA3 |
|                                       |                         | 5.5/7.5   | ATV71WU55N4   | TB  | ATV71E5U55N4 | TB  |
|                                       |                         | 7.5/10  | ATV71WU75N4   | TB  | ATV71E5U75N4 | TB  |
|                                       |                         | 11/15   | ATV71WD11N4   | TC  | ATV71E5D11N4 | TC  |
|                                       |                         | 15/20   | ATV71WD15N4   | TD  | ATV71E5D15N4 | TD  |
|                                       |                         | 18.5/25   | ATV71WD18N4   | TD  | ATV71E5D18N4 | TD  |
|                                       |                         | 22/30   | ATV71WD22N4   | TD  | ATV71E5D22N4 | TD  |
|                                       |                         | 30/40   | ATV71WD30N4   | TF  | ATV71E5D30N4 | TF  |
|                                       |                         | 37/50   | ATV71WD37N4   | TF  | ATV71E5D37N4 | TF  |
|                                       |                         | 45/60   | ATV71WD45N4   | TG  | ATV71E5D45N4 | TG  |
|                                       |                         | 55/75   | ATV71WD55N4   | TG  | ATV71E5D55N4 | TG  |
| 75/100                                | ATV71WD75N4             | TG  | ATV71E5D75N4  | TG  |              |     |

(1) For ATV71W... range only.

(2) SoMove setup software : available from 2011. Altivar 71 is also supported by Powersuite software workshop.

# Altivar 71

90...500 kW

Complex, high-power machines  
**IP54 Altivar 71 kit with preassembled enclosure**



| Drive       |                                     | Kit      |
|-------------|-------------------------------------|----------|
| ATV71HD90N4 |                                     | VW3A9541 |
| ATV71HC11N4 |                                     | VW3A9542 |
| ATV71HC13N4 |                                     | VW3A9543 |
| ATV71HC16N4 |                                     | VW3A9544 |
| ATV71HC20N4 |                                     | VW3A9545 |
| ATV71HC25N4 |                                     |          |
| ATV71HC28N4 |                                     |          |
| ATV71HC20N4 | With VW3A7101 braking unit          | VW3A9546 |
| ATV71HC25N4 | With VW3A7101 braking unit          |          |
| ATV71HC28N4 | With VW3A7101 braking unit          |          |
| ATV71HC31N4 | Without braking unit                | VW3A9547 |
| ATV71HC40N4 |                                     |          |
| ATV71HC50N4 |                                     | VW3A9548 |
|             | VW3A7102 braking unit               | VW3A9549 |
|             | Additional empty enclosure (600 mm) | VW3A9550 |
|             | Additional empty enclosure (800 mm) | VW3A9551 |

3



| Dimensions (in mm) | width x height x depth |
|--------------------|------------------------|
| T11                | : 330 x 950 x 377      |
| T13                | : 585 x 950 x 377      |
| T15                | : 1110 x 1150 x 377    |

| Type of drive                  |                         | Three-phase  | Three-phase   |     |   |
|--------------------------------|-------------------------|--|---|-----|---|
| Supply voltage                 |                         | 380...480 V  | 500...690 V   |     |   |
| Degree of protection           |                         | Sideways and front IP31 - Top IP20 - Bottom IP00   |   |     |   |
| Drive                          | Output frequency        | 0.1...500Hz  |   |     |   |
|                                | Type of control         | Asynchronous motor   | Flux vector control with or without sensor, voltage/frequency ratio (2 or 5 points), ENA System |     |   |
|                                |                         | Synchronous motor  | Vector control without speed feedback   |     |   |
|                                | Transient overtorque    | 220% of nominal motor torque for 2 seconds, and 170% for 60 seconds  |   |     |   |
| Speed range                    |                         | 1...1000 in closed loop mode with encoder feedback, 1...100 in open loop mode  |   |     |   |
| Functions                      | Number of functions     |  | > 150   |     |   |
|                                | Number of preset speeds |  | 16  |     |   |
|                                | Number of I/O           | Analog inputs  | 2...4   |     |   |
|                                |                         | Logic inputs   | 6...20  |     |   |
|                                | Analog outputs          | Logic outputs  | 0...8   |     |   |
|                                |                         | Relay outputs  | 2...4   |     |   |
|                                | Safety input            |  | 1   |     |   |
|                                | Dialogue                |  | Remote graphic display terminal, SoMove setup software (1)                                      |     |   |
| Communication                  | Integrated              | Modbus and CANopen   |   |     |   |
|                                | As an option            | Modbus TCP, Modbus/Uni-Telway, Fipio, Modbus Plus, Profbus DP, Profbus DP V1, DeviceNet, EthernetIP, CC-Link, INTERBUS |   |     |   |
| Cards (available as an option) |                         | Multi-pump cards, I/O extension cards, "Controller Inside" programmable card   |   |     |   |
| Reduction of current harmonics |                         | Optional AC choke, Altivar AFE (Active Front End)  |   |     |   |
| EMC filter                     | Integrated              | C3 EMC   |   |     |   |
|                                | As an option            | C1 EMC   |   |     |   |
| Motor power                    | kW/HP                   | 90/125   | ATV71QD90N4   | T11 | – |
|                                |                         | 110/150  | ATV71QC11N4   | T11 | – |
|                                |                         | 132/200  | ATV71QC13N4   | T11 | – |
|                                |                         | 160/250  | ATV71QC16N4   | T13 | – |
|                                |                         | 200/300  | ATV71QC20N4   | T13 | – |
|                                |                         | 250/400  | ATV71QC25N4   | T13 | – |
|                                |                         | 315/500  | ATV71QC31N4   | T15 | – |
|                                |                         | 400/600  | ATV71QC40N4   | T15 | – |
|                                |                         | 500/700  | ATV71QC50N4   | T15 | – |

|  | 500 V | 575 V | 690 V |   |                |
|--|-------|-------|-------|---|----------------|
|  | kW    | HP    | kW    |   |                |
|  | 90    | 125   | 110   | – | ATV71QC11Y T11 |
|  | 110   | 150   | 132   | – | ATV71QC13Y T11 |
|  | 132   | -     | 160   | – | ATV71QC16Y T11 |
|  | 160   | 200   | 200   | – | ATV71QC20Y T13 |
|  | 200   | 250   | 250   | – | ATV71QC25Y T13 |
|  | 250   | 350   | 315   | – | ATV71QC31Y T13 |
|  | 315   | 450   | 400   | – | ATV71QC40Y T15 |
|  | 400   | 550   | 500   | – | ATV71QC50Y T15 |
|  | 500   | 700   | 630   | – | ATV71QC63Y T15 |

(1) SoMove setup software : available during 2011. Altivar 71 also works with the PowerSuite software workshop.



# Altivar 71 Plus

90...2000 kW

Complex, high-power machines  
Solutions in IP23 and IP54 ready-assembled enclosures



| Dimensions (in mm)           |                               | width x height x depth |  |
|------------------------------|-------------------------------|------------------------|--|
| <b>ATV71EXC2C...</b>         |                               |                        |  |
| <b>E1</b> : 600 x 2162 x 642 | <b>E3</b> : 1000 x 2162 x 642 |                        |  |
| <b>E2</b> : 800 x 2162 x 642 | <b>E4</b> : 1200 x 2162 x 642 |                        |  |

| Type of drive                  |                         | Three-phase 380...480 V<br>(1)  |        |
|--------------------------------|-------------------------|---|--------|
| Degree of protection           |                         | IP23, IP54  |        |
| Drive                          | Output frequency        | 0...500 Hz  |        |
|                                | Type of control         | Asynchronous motor<br>Flux vector control with or without sensor, voltage/frequency ratio (2 or 5 points), ENA System   |        |
|                                |                         | Synchronous motor<br>Vector control without speed feedback  |        |
|                                | Transient overtorque    | 220% of nominal motor torque for 2 seconds, and 170% for 60 seconds   |        |
| Speed range                    |                         | 1...1000 in closed loop mode with encoder feedback, 1...100 in open loop mode   |        |
| Functions                      | Number of functions     | > 150   |        |
|                                | Number of preset speeds | 16  |        |
|                                | Number of I/O           | Analog inputs   | 2...4  |
|                                |                         | Logic inputs  | 6...20 |
|                                |                         | Analog outputs  | 1...3  |
|                                |                         | Logic outputs   | 0...8  |
|                                |                         | Relay outputs   | 2...4  |
|                                |                         | Safety input  | 1      |
| Dialogue                       |                         | Remote graphic display terminal, SoMove setup software (2)  |        |
| Communication                  | Integrated              | Modbus and CANopen  |        |
|                                | As an option            | Modbus TCP, Modbus/Uni-Telway, EtherNet/IP, EtherCAT, DeviceNet, PROFIBUS DP V0 et V1, INTERBUS, CC-Link.   |        |
| Cards (available as an option) |                         | Encoder interface cards, I/O extension cards, "Controller Inside" programmable card,  |        |
| Reduction of current harmonics |                         | DC choke or Integrated AC choke, variant 12 pulse, AFE Altivar (Active Front End)   |        |
| EMC filter                     | Integrated              | C3 EMC  |        |
|                                | As an option            | External C1 EMC   |        |
| Equipment                      |                         | A wide range of options listed in the catalogue provides add-ons for the standard offer as required.<br>As well as the options listed in the catalogue, it is possible to customise the equipment. Just contact our teams of experts direct.<br>- Water cooling solution<br>- Integration of specific options |        |

3

| IP23 | Three-phase 380...415 V |                |    | Three-phase 500 V |                |    | Three-phase 690 V |                |    |
|------|-------------------------|----------------|----|-------------------|----------------|----|-------------------|----------------|----|
|      | kW/HP                   | Dimensions     |    | kW                | Dimensions     |    | kW                | Dimensions     |    |
|      | 90/125                  | ATV71EXC2D90N4 | E1 | 90                | ATV71 EXC2D90N | E1 | -                 |                |    |
|      | 110/150                 | ATV71EXC2C11N4 | E1 | 110               | ATV71 EXC2C11N | E1 | 110               | ATV71 EXC2C11Y | E1 |
|      | 132/200                 | ATV71EXC2C13N4 | E1 | 132               | ATV71 EXC2C13N | E1 | 132               | ATV71 EXC2C13Y | E1 |
|      | 160/250                 | ATV71EXC2C16N4 | E1 | 160               | ATV71 EXC2C16N | E2 | 160               | ATV71 EXC2C16Y | E1 |
|      | 200/300                 | ATV71EXC2C20N4 | E2 | 200               | ATV71 EXC2C20N | E2 | 200               | ATV71 EXC2C20Y | E2 |
|      | 250/400                 | ATV71EXC2C25N4 | E2 | 250               | ATV71 EXC2C25N | E2 | 250               | ATV71 EXC2C25Y | E2 |
|      | 280/450                 | ATV71EXC2C28N4 | E2 | -                 | -              | -  | -                 |                |    |
|      | 315/500                 | ATV71EXC2C31N4 | E3 | 315               | ATV71 EXC2C31N | E4 | 315               | ATV71 EXC2C31Y | E2 |
|      | 400/600                 | ATV71EXC2C40N4 | E3 | 400               | ATV71 EXC2C40N | E4 | 400               | ATV71 EXC2C40Y | E4 |
|      | 500/700                 | ATV71EXC2C50N4 | E4 | 500               | ATV71 EXC2C50N | E4 | 500               | ATV71 EXC2C50Y | E4 |
|      |                         |                |    |                   |                |    | 630               | ATV71EXC2C63N4 | E4 |

(1) The Altivar 71 range in ready-assembled enclosure consists of:

- An ATV71H... drive
- A switch and fast-acting fuses
- An IP65 remote mounting kit for graphic display terminal

(2) SoMove setup software : available from 2011. Altivar 71 is also supported by Powersuite software workshop.

IP23 offer available up to 2000 kW. For ratings above 630 kW, please consult your Customer Care Centre.

# Altivar 71 Plus

90...2000 kW

## Complex, high-power machines

## Solutions in IP23 and IP54 ready-assembled enclosures



| Dimensions (in mm)            |                                | width x height x depth |  |
|-------------------------------|--------------------------------|------------------------|--|
| <b>ATV71EX...</b>             |                                |                        |  |
| <b>E5</b> : 600 x 2262 x 642  | <b>E9</b> : 600 x 2362 x 642   |                        |  |
| <b>E6</b> : 800 x 2262 x 642  | <b>E10</b> : 800 x 2362 x 642  |                        |  |
| <b>E7</b> : 1000 x 2262 x 642 | <b>E11</b> : 1000 x 2362 x 642 |                        |  |
| <b>E8</b> : 1200 x 2262 x 642 | <b>E12</b> : 1200 x 2362 x 642 |                        |  |
|                               | <b>E13</b> : 1400 x 2362 x 642 |                        |  |
|                               | <b>E14</b> : 1600 x 2362 x 642 |                        |  |

| IP54 (1)<br>Compact floor-standing enclosure | Three-phase<br>380...415 V |                |    | Three-phase<br>500 V |               |    | Three-phase<br>690 V |               |    |
|--|----------------------------|----------------|----|----------------------|---------------|----|----------------------|---------------|----|
|  | kW/HP                      | Dimensions     |    | kW                   | Dimensions    |    | kW                   | Dimensions    |    |
|  | 90/125                     | ATV71EXC5D90N4 | E5 | 90                   | ATV71EXC5D90N | E5 | –                    |               |    |
|  | 110/150                    | ATV71EXC5C11N4 | E5 | 110                  | ATV71EXC5C11N | E5 | 110                  | ATV71EXC5C11Y | E5 |
|  | 132/200                    | ATV71EXC5C13N4 | E5 | 132                  | ATV71EXC5C13N | E5 | 132                  | ATV71EXC5C13Y | E5 |
|  | 160/250                    | ATV71EXC5C16N4 | E5 | 160                  | ATV71EXC5C16N | E6 | 160                  | ATV71EXC5C16Y | E5 |
|  | 220/350                    | ATV71EXC5C20N4 | E6 | 200                  | ATV71EXC5C20N | E6 | 200                  | ATV71EXC5C20Y | E6 |
|  | 250/400                    | ATV71EXC5C25N4 | E6 | 250                  | ATV71EXC5C25N | E6 | 250                  | ATV71EXC5C25Y | E6 |
|  | 280/450                    | ATV71EXC5C28N4 | E6 | –                    | –             | –  | –                    |               |    |
|  | 315/500                    | ATV71EXC5C31N4 | E7 | 315                  | ATV71EXC5C31N | E8 | 315                  | ATV71EXC5C31Y | E6 |
|  | 400/600                    | ATV71EXC5C40N4 | E7 | 400                  | ATV71EXC5C40N | E8 | 400                  | ATV71EXC5C40Y | E8 |
|  | 500/700                    | ATV71EXC5C50N4 | E8 | 500                  | ATV71EXC5C50N | E8 | 500                  | ATV71EXC5C50Y | E8 |
|  |                            |                |    |                      |               |    | 630                  | ATV71EXC5C63Y | E8 |

(1) The IP54 offer is available for power ratings up to 630 kW. For higher power ratings up to 2000 kW, consult your customer care centre.

| IP54 (2)<br>Separate air flow | Three-phase<br>380...415 V |                |     | Three-phase<br>500 V |               |     | Three-phase<br>690 V |               |     |
|-------------------------------|----------------------------|----------------|-----|----------------------|---------------|-----|----------------------|---------------|-----|
|                               | kW/HP                      | Dimensions     |     | kW                   | Dimensions    |     | kW                   | Dimensions    |     |
|                               | 90/125                     | ATV71EXS5D90N4 | E9  | 90                   | ATV71EXS5D90N | E11 | –                    |               |     |
|                               | 110/150                    | ATV71EXS5C11N4 | E9  | 110                  | ATV71EXS5C11N | E11 | 110                  | ATV71EXS5C11Y | E11 |
|                               | 132/200                    | ATV71EXS5C13N4 | E9  | 132                  | ATV71EXS5C13N | E11 | 132                  | ATV71EXS5C13Y | E11 |
|                               | 160/250                    | ATV71EXS5C16N4 | E9  | 160                  | ATV71EXS5C16N | E12 | 160                  | ATV71EXS5C16Y | E11 |
|                               | 220/350                    | ATV71EXS5C20N4 | E10 | 200                  | ATV71EXS5C20N | E12 | 200                  | ATV71EXS5C20Y | E12 |
|                               | 250/400                    | ATV71EXS5C25N4 | E10 | 250                  | ATV71EXS5C25N | E12 | 250                  | ATV71EXS5C25Y | E12 |
|                               | 280/450                    | ATV71EXS5C28N4 | E10 | –                    | –             | –   | –                    |               |     |
|                               | 315/500                    | ATV71EXS5C31N4 | E13 | 315                  | ATV71EXS5C31N | E14 | 315                  | ATV71EXS5C31Y | E12 |
|                               | 400/600                    | ATV71EXS5C40N4 | E13 | 400                  | ATV71EXS5C40N | E14 | 400                  | ATV71EXS5C40Y | E14 |
|                               | 500/700                    | ATV71EXS5C50N4 | E14 | 500                  | ATV71EXS5C50N | E14 | 500                  | ATV71EXS5C50Y | E14 |
|                               |                            |                |     |                      |               |     | 630                  | ATV71EXS5C63Y | E14 |

(2) The IP54 offer with separate air flow is available for power ratings up to 630 kW. For higher power ratings up to 2000 kW, consult your customer care centre.



| Dimensions (in mm) width x height x depth without remote graphic terminal |                             |
|---|-----------------------------|
| <b>T4</b> : 175 x 295 x 161   | <b>T6</b> : 240 x 420 x 210 |
| <b>T5A</b> : 210 x 295 x 187  | <b>T7</b> : 240 x 550 x 230 |
| <b>T5B</b> : 230 x 400 x 187  |                             |

| Type of drive                         |                         | Three-phase   | Three-phase   |              |              |     |
|---------------------------------------|-------------------------|---|---|--------------|--------------|-----|
| Supply voltage                        |                         | 200...240 V   | 380...480 V   |              |              |     |
| <b>Degree of protection</b>           |                         | IP20 for unprotected drives and IP41 on the upper part  |   |              |              |     |
| <b>Drive</b>                          | Output frequency        | 0...599 Hz  |   |              |              |     |
|                                       | Type of control         | Asynchronous motor  | Flux vector control with or without sensor, voltage/frequency ratio |              |              |     |
|                                       |                         | Synchronous motor   | Vector control with and without speed feedback                      |              |              |     |
|                                       | Transient overtorque    |   | 220% of nominal motor torque for 2 seconds, and 170% for 60 seconds |              |              |     |
| <b>Speed range</b>                    |                         | 1...1000 in closed loop mode with encoder feedback, 1...100 in open loop mode                               |   |              |              |     |
| <b>Functions</b>                      | Number of functions     |   | > 150   |              |              |     |
|                                       | Number of preset speeds |   | 16  |              |              |     |
|                                       | Number of I/O           | Analog inputs   | 2...4   |              |              |     |
|                                       |                         | Logic inputs  | 6...20  |              |              |     |
|                                       |                         | Analog outputs  | 1...3   |              |              |     |
|                                       |                         | Logic outputs   | 0...8   |              |              |     |
|                                       |                         | Relay outputs   | 2...4   |              |              |     |
| Safety input                          |                         | 1   |   |              |              |     |
| <b>Dialogue</b>                       |                         | Remote graphic display terminal, SoMove setup software (1)  |   |              |              |     |
| <b>Communication</b>                  | Integrated              | Modbus and CANopen  |   |              |              |     |
|                                       | As an option            | Ethernet, PROFIBUS DP, DeviceNet, Uni-Telway, INTERBUS  |   |              |              |     |
| <b>Cards (available as an option)</b> |                         | Encoder interface cards, I/O extension cards, "Controller Inside" programmable card, Encoder emulation card |   |              |              |     |
| <b>Reduction of current harmonics</b> |                         | Integrated DC choke or supplied with the product  |   |              |              |     |
| <b>EMC filter</b>                     | Integrated              | C2 EMC up to 5.5 kW   |   |              |              |     |
|                                       | As an option            | External C2 EMC from 7.5 kW   |   |              |              |     |
| <b>Motor power</b>                    | kW / HP / A             | 4 / 5 / 10  | –   | ATV71LD10N4Z | T4           |     |
|                                       |                         | 5,5 / 7,5 / 14  | –   | ATV71LD14N4Z | T4           |     |
|                                       |                         | 5,5 / 7,5 / 27  | ATV71LD27M3Z  | T5B          | –            |     |
|                                       |                         | 7,5 / 10 / 17   | –   | –            | ATV71LD17N4Z | T5A |
|                                       |                         | 7,5 / 10 / 33   | ATV71LD33M3Z  | T5B          | –            |     |
|                                       |                         | 11 / 15 / 27  | –   | –            | ATV71LD27N4Z | T5B |
|                                       |                         | 11 / 15 / 54  | ATV71LD54M3Z  | T6           | –            |     |
|                                       |                         | 15 / 20 / 33  | –   | –            | ATV71LD33N4Z | T5B |
|                                       |                         | 15 / 20 / 66  | ATV71LD66M3Z  | T6           | –            |     |
|                                       |                         | 22 / 30 / 48  | –   | –            | ATV71LD48N4Z | T7  |

(1) SoMove setup software : available from 2011. Altivar LIFT is also supported by Powersuite software workshop.



| Type of card       | I/O extension  | Extended   |
|--------------------|--|--|
| <b>Description</b> | <b>Logic</b><br>1 relay logic output ("C/O" contact)<br>4 x 24 VDC positive or negative logic inputs<br>2 x 24 VDC open collector positive or negative logic outputs<br>1 input for PTC probes | 1 x 0...20 mA differential current analog input<br>1 software-configurable voltage (0...10 VDC) or current (0...20 mA) analog input<br>2 software-configurable voltage ( $\pm 10V$ , 0...10 VDC) or current (0...20 mA) analog inputs<br>1 relay logic output ("C/O" contact)<br>4 x 24 VDC positive or negative logic inputs<br>2 x 24 VDC open collector positive or negative logic outputs, 1 input for PTC probes, 1 frequency control input |
| <b>Reference</b>   | <b>VW3A3201</b>  | <b>VW3A3202</b>  |

3

**"Controller Inside" programmable card**



| Type of card       | Programmable "Controller Inside"   |
|--------------------|--|
| <b>Description</b> | 10 logic inputs, 2 of which can be used for 2 counters or 4 of which can be used for 2 incremental encoders<br>2 analog inputs, 6 logic outputs, 2 analog outputs, a master port for the CANopen bus, a PC port for programming with the PS 1131 software workshop |
| <b>Reference</b>   | <b>VW3A3501</b>  |

## Encoder interface cards



| Type of card        | Encoder interface with       |                              |                   |
|---------------------|------------------------------|------------------------------|-------------------|
|                     | Differential outputs (RS422) | Open collector outputs (NPN) | Push-pull outputs |
| Operating frequency | 300 kHz                      |                              |                   |
| Reference           | 5 V                          | VW3A3401                     | –                 |
|                     | 12 V                         | –                            | VW3A3403          |
|                     | 15 V                         | VW3A3402                     | VW3A3404          |
|                     | 24 V                         | –                            | VW3A3407          |

3

| Type of card (1)          | Resolver                         | Universal                            | Sincos Absolute | Incremental with emulation         |
|---------------------------|----------------------------------|--------------------------------------|-----------------|------------------------------------|
| Speed feedback resolution | 12 bits                          | 16 bits                              | 16 bits         | 10,000                             |
| Encoder type supported    | Resolver with 2, 4, 6 or 8 poles | "SinCos, SinCosHiperface EnDat, SSI" | Sincos Absolute | "Incremental RS 422 - 5 V or 15 V" |
| References                | VW3A3408                         | VW3A3409                             | VW3A3410        | VW3A3411                           |

Supported by Altivar LIFT and Altivar71 with S383 firmware version



| Communication tools        | Remote display terminal (IP54 & IP65) | Remote graphic display terminal | Multi-loader | Simple Loader | Dongle Bluetooth® (TM) |
|----------------------------|---------------------------------------|---------------------------------|--------------|---------------|------------------------|
| Altistart 01               |                                       |                                 |              |               |                        |
| Altistart 22               | x                                     |                                 |              |               | x                      |
| Altistart 48               | x                                     |                                 |              |               |                        |
| Altivar 12                 | x                                     |                                 | x            | x             | x                      |
| Altivar 212                | x                                     | x                               | x            | x             | x                      |
| Altivar 312                | x                                     | x                               | x            | x             | x                      |
| Altivar 31C                | x                                     |                                 |              | x             | x                      |
| Altivar 32                 | x                                     | x                               | x            | x             |                        |
| Altivar LIFT               |                                       | x                               | x            | x             | x                      |
| Altivar 61                 |                                       | x                               | x            | x             | x                      |
| Altivar 71                 |                                       | x                               | x            | x             | x                      |
| Altivar 61 Plus            |                                       | x                               | x            | x             | x                      |
| Altivar 71 Plus            |                                       | x                               | x            | x             | x                      |
| Altivar 61Q (Water Cooled) |                                       | x                               | x            | x             | x                      |
| Altivar 71Q (Water Cooled) |                                       | x                               | x            | x             | x                      |

| Accessories & Options                                  | ALTISTART   |    |    | ALTIVAR |    |     |     |     |    |    |    |      |         |         |     |     |
|--|---|----|----|---------|----|-----|-----|-----|----|----|----|------|---------|---------|-----|-----|
|  | 01  | 22 | 48 | 12      | 21 | 212 | 312 | 31C | 32 | 61 | 71 | LIFT | 61 Plus | 71 Plus | 61Q | 71Q |
| Panel cut-out adaptor for mounting control unit at 90° |   |    |    |         |    | x   |     |     |    |    |    |      |         |         |     |     |
| Ferrite suppressors for downstream contactor opening   |   |    |    | x       | x  |     | x   | x   |    |    |    |      |         |         |     |     |
| Additional EMC filter                                  | x   | x  | x  | x       | x  | x   | x   | x   | x  | x  | x  | x    | x       | x       | x   | x   |
| Passive filters  |   |    |    |         |    |     | x   | x   |    |    | x  | x    | x       | x       | x   | x   |
| Sinus filters  |   |    |    |         |    |     | x   | x   |    |    | x  | x    | x       | x       | x   | x   |
| Line choke   | x   |    |    |         | x  | x   | x   | x   | x  | x  | x  | x    | x       | x       | x   | x   |
| Motor chokes   | x   |    | x  | x       | x  | x   | x   | x   | x  | x  | x  | x    | x       | x       | x   | x   |
| EMC conformity kit                                     | x   |    | x  |         |    |     |     |     |    |    |    |      |         |         |     |     |
| UL Type 1 conformity kit                               |   |    | x  | x       |    |     | x   |     |    |    |    |      |         |         |     |     |
| Mechanical base kit for mounting GV2 circuit-breaker   |   |    |    |         |    | x   |     |     |    |    |    |      |         |         |     |     |
| Mounting plates  | x   |    |    | x       |    | x   | x   | x   | x  | x  |    | x    |         |         |     | x   |
| Braking resistors for vertical movements               |   |    |    |         |    |     |     | x   | x  |    |    |      |         |         |     |     |
| Braking resistors and braking units                    | x   |    |    | x       | x  | x   | x   | x   | x  | x  | x  | x    | x       | x       | x   | x   |
| References   | If options or accessories not listed, please refer to the Schneider Electric catalogue. |    |    |         |    |     |     |     |    |    |    |      |         |         |     |     |

For Altivar 1000 or 1100, please consult our Customer Care Centre.



| Industrial protocols | ALTISTART   |    |    | ALTIVAR |     |     |     |    |    |    |      |         |         |     |     |      |      |
|----------------------|---|----|----|---------|-----|-----|-----|----|----|----|------|---------|---------|-----|-----|------|------|
|                      | 01  | 22 | 48 | 12      | 212 | 312 | 31C | 32 | 61 | 71 | LIFT | 61 Plus | 71 Plus | 61Q | 71Q | 1000 | 1100 |
| Canopen              |   |    |    |         |     | ●   | ●   | ●  | ●  | ●  | ●    | ●       | ●       | ●   | ●   | ○    |      |
| CANopen Daisy chain  |   |    |    |         |     | ○   |     |    |    |    |      |         |         |     |     |      |      |
| CC-Link              |   |    |    |         |     |     |     |    | ○  | ○  | ○    | ○       | ○       | ○   | ○   |      |      |
| DeviceNet            |   |    | △  |         |     | ○   | ○   | ○  | ○  | ○  | ○    | ○       | ○       | ○   | ○   | ○    |      |
| EtherCAT             |   |    | △  |         |     |     |     |    | ●  | ●  |      |         |         |     |     |      |      |
| Ethernet             |   |    | △  |         |     |     |     |    |    |    |      |         |         |     |     |      | ●    |
| Ethernet IP          |   |    |    |         |     |     |     | ○  | ○  | ○  | ○    | ○       | ○       | ○   | ○   |      |      |
| Ethernet TCP/IP      |   |    |    |         |     |     | ○   |    |    | ○  |      |         |         |     |     |      |      |
| Fipio                |   |    | ○  |         |     | ○   | ○   |    | ○  |    |      | ○       |         | ○   |     |      |      |
| INTERBUS S           |   |    |    |         |     |     |     |    | ○  | ○  | ○    | ○       | ○       | ○   | ○   |      |      |
| Modbus               |   | ●  | ●  | ●       | ●   | ●   | ●   | ●  | ●  | ●  | ●    | ●       | ●       | ●   | ●   | ●    | ●    |
| Modbus Plus          |   |    |    |         |     |     |     |    | ○  |    |      | ○       |         | ○   |     |      |      |
| Modbus TCP           |   |    |    |         |     | ○   |     | ○  | ○  | ○  | ○    | ○       | ○       | ○   | ○   |      |      |
| Modbus/ Unitelway    |   |    |    |         |     |     |     |    | ○  | ○  | ○    | ○       | ○       | ○   | ○   |      |      |
| PROFIBUS DP          |   |    | △  |         |     | ○   | ○   | ○  | ○  | ○  | ○    | ○       | ○       | ○   | ○   | ●    | ●    |
| PROFIBUS DP V0       |   |    |    |         |     |     |     | ○  | ○  | ○  | ○    | ○       | ○       | ○   | ○   |      |      |
| PROFIBUS DP V1       |   |    |    |         |     |     |     | ○  | ○  | ○  | ○    | ○       | ○       | ○   | ○   |      |      |
| References           | Please refer to the Schneider Electric catalogue or consult our Customer Care Centre. |    |    |         |     |     |     |    |    |    |      |         |         |     |     |      |      |

| HVAC protocols | ALTISTART   |    |    | ALTIVAR |     |     |     |    |    |    |      |         |         |     |     |      |      |
|----------------|---|----|----|---------|-----|-----|-----|----|----|----|------|---------|---------|-----|-----|------|------|
|                | 01  | 22 | 48 | 12      | 212 | 312 | 31C | 32 | 61 | 71 | LIFT | 61 Plus | 71 Plus | 61Q | 71Q | 1000 | 1100 |
| Lonworks       |   |    |    |         | ○   |     |     |    | ○  |    |      | ○       |         | ○   |     |      |      |
| Metasys N2     |   |    |    |         | ●   |     |     |    | ○  |    |      | ○       |         | ○   |     |      |      |
| Apogee FLN     |   |    |    |         | ●   |     |     |    | ○  |    |      | ○       |         | ○   |     |      |      |
| BACnet         |   |    |    |         | ●   |     |     |    | ○  |    |      | ○       |         | ○   |     |      |      |
| References     | Please refer to the Schneider Electric catalogue or consult our Customer Care Centre. |    |    |         |     |     |     |    |    |    |      |         |         |     |     |      |      |

● Embedded      ○ Option      △ Gateway

## Communication modules



| Altistart 48/Altivar 31 starters/drives |           | Ethernet/Modbus  | DeviceNet/Modbus | Fipio/Modbus | PROFIBUS DP/Modbus    |                          |
|---|-----------|------------------|------------------|--------------|-----------------------|--------------------------|
| Parameter setting                       |           | –                | –                | –            | Standard configurator | ABC configurator program |
| References                              | Bridge    | <b>TSXETG100</b> | –                | –            | –                     | –                        |
|   | Gateway   | –                | <b>LUFP9</b>     | <b>LUFP1</b> | <b>LA9P307</b>        | <b>LUFP7</b>             |
| Cable references                        | L = 0.3 m | –                | VW3A8306R03      | VW3A8306R03  | –                     | VW3A8306R03              |
|   | L = 1 m   | –                | VW3A8306R10      | VW3A8306R10  | VW3P07306R10          | VW3A8306R10              |
|   | L = 3 m   | VW3A8306D30      | VW3A8306R30      | VW3A8306R30  | –                     | VW3A8306R30              |

# Controllers, drives, motors and linear motion axes

## Selection guide

3

|                                 | ⇒ Applications :   | ⇒ Applications :   |   |   |
|---------------------------------|--|--|---|---|
|                                 | Lexium 32 is the perfect drive system for applications involving high-precision, dynamic positioning.  | Lexium SDx stepper drives and motors are used for short-distance positioning applications requiring maximum accuracy and high torque.  |   |   |
|                                 | <b>Servo Drives</b><br><br><b>Lexium 32</b><br><br>   | <b>Servo Motors</b><br><br><b>Lexium BMH</b><br><br><br><br><b>Lexium BSH</b><br><br>  | <b>Stepper Drives</b><br><br><b>Lexium SD2</b><br><br><br><br><b>Lexium SD3</b><br><br> | <b>Stepper Motors</b><br><br><b>Lexium BRS2</b><br><br><br><br><b>Lexium BRS3</b><br><br> |
| <b>Machines</b>                 | Packaging machines<br>Material handling machines<br>Material working machines<br>Assembling machines   | Printing machines<br>Labelling machines<br>Screen printing machines  |   |   |
| <b>Description</b>              | The Lexium 32 servo range consists of three high-performance book-size servo drive models – Lexium 32 Compact, Lexium 32 Advanced and Lexium 32 Modular – and two motor families – the versatile medium-inertia Lexium BMH and the dynamic low-inertia Lexium BSH. | The Lexium SDx stepper motor drive range consists of two high-precision stepper drive lines – the three-phase stepper drives Lexium SD3 and the two-phase stepper drives Lexium SD2. These drive lines are complemented by two perfectly matched stepper motor families – Lexium BRS3 three-phase stepper motors and Lexium BRS2 two-phase stepper motors. |   |   |
| <b>Power range</b>              | 0.15...7 kW  | up to 750 W  |   |   |
| <b>Voltage range</b>            | 115...240 VAC, 400...480 VAC   | 24...48 VDC, 115...240 VAC   |   |   |
| <b>Speed</b>                    | up to 8000 rpm   | up to 1000 rpm   |   |   |
| <b>Torque</b>                   | up to 84 Nm  | up to 16.5 Nm  |   |   |
| <b>Communication interfaces</b> | CANopen, CANmotion, PROFIBUS DP, DeviceNet, EtherNet/IP  | CANopen, CANmotion, PROFIBUS DP or Pulse/Direction   |   |   |
|                                 | <b>Safety function (STO)</b> on board<br>Enhanced Safety Module (SS1, SS2, SLS, SOS)<br>Encoder module for digital and analog encoders and resolvers   | <b>Safety function (STO)</b> on board<br>(Lexium SD3 28)   |   |   |



⇒ Applications :

Lexium Integrated Drives allow for extremely space-saving decentralised motion solutions.

⇒ Applications :

The Lexium Linear Motion products are designed for maximum flexibility, performance and cost-effectiveness. This range offers products for all linear movements in the automation industry from single-axis to multi-axis systems.

**Integrated Drives**

**Lexium ILA**



**Lexium ILE**



**Lexium ILS**



**Lexium ILP / ILT**



**Linear Motion**

**Lexium PAS**



**Lexium CAS**



**Lexium TAS**



**Lexium MAX**

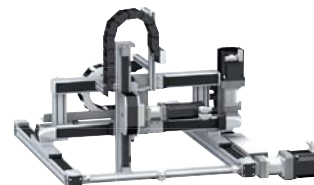

Format adjustment  
Printing machines  
Material handling machines

Material handling machines  
Material working machines  
On-the-fly working machines  
Assembling machines

The Lexium ILx Integrated Drives comprise motor, positioning controller, power electronics, fieldbus and "Safe Torque Off" safety function in an extremely compact single device. Lexium ILx Integrated Drives are available with multiple motor technologies (servo, brushless DC, stepper).

Lexium Linear Motion is a comprehensive linear motion range comprising Lexium PAS portal axes, Lexium TAS linear tables, Lexium CAS cantilever and telescopic axes and Lexium MAX multi-axis systems.

150 - 305 W  
12...48 VDC, 95 to 264 VAC  
up to 9000 rpm  
up to 12 Nm

RS485, CANopen, PROFIBUS DP, DeviceNet, EtherNet/IP, EtherCAT, Ethernet POWERLINK, Modbus TCP, Pulse/Direction

**Safety function (STO)** on board  
(Lexium ILA, Lexium ILE, Lexium ILS)

Stand-alone device with controller inside (Lexium ILP)

**Single axes:**

Stroke up to 5.5 m  
Load up to 150 kg  
Speed up to 8 m/s

**Multi axes:**

Stroke up to 5.5 m  
Load up to 130 kg  
Speed up to 4 m/s  
Available as individual components or completely pre-assembled, customised systems with drives and motors



| Main functions  |  | Lexium 32 Compact   | Lexium 32 Advanced  | Lexium 32 Modular  |
|---|--|---|---|--|
| <b>Communication</b>  | Integrated   | Modbus serial link<br>Pulse train   | Modbus serial link<br>CANopen, CANmotion machine bus                                | Modbus serial link<br>Pulse train  |
|   | As an option   | –   | –   | CANopen, CANmotion machine bus, DeviceNet, EtherNet/IP, PROFIBUS DP, EtherCAT, I/O module                                    |
|   | Operating modes  | Manual mode (JOG)<br>Electronic gearbox<br>Speed control<br>Current control | Homing<br>Manual mode (JOG)<br>Speed control<br>Current control<br>Position control | Homing<br>Manual mode (JOG)<br>Motion sequence<br>Electronic gearbox<br>Speed control<br>Current control<br>Position control |
|   | Functions  | Auto-tuning, monitoring, stopping, conversion<br>–                          | Stop window<br>Rapid entry of position values                                       | Stop window<br>Rapid entry of position values<br>Rotary axes<br>Position register  |
| <b>24 V <math>\overline{\text{---}}</math> logic inputs</b>           | 6, reassignable  | 3, reassignable   | 4, reassignable   |  |
| <b>24 V <math>\overline{\text{---}}</math> capture inputs (1) (2)</b> | –  | 1   | 2   |  |
| <b>24 V <math>\overline{\text{---}}</math> logic outputs (1)</b>      | 5, reassignable  | 2, reassignable   | 3, reassignable   |  |
| <b>Analog inputs</b>  | 2  | –   |   |  |
| <b>Pulse control input</b>  | 1, configurable as: RS 422 link<br>5 V or 24 V push-pull<br>5 V or 24 V open collector |   |   |  |
| <b>ESIM PTO output</b>  | RS 422 link  |   |   |  |
| <b>Safety functions</b>   | Integrated   | "Safe Torque Off" STO   |   |  |
|   | As an option   | –   |   | Safe Stop 1 (SS1) and Safe Stop 2 (SS2)<br>Safe Operating Stop (SOS)<br>Safe Limited Speed (SLS)                             |
| <b>Sensor</b>   | Integrated   | SinCos Hiperface® sensor  |   |  |
|   | As an option   | –   |   | Resolver encoder<br>Analog encoder<br>Digital encoder  |
| <b>Architecture</b>   |  | Control via:<br>Logic or analog I/O   | Control via:<br>Motion controller via CANopen and CANmotion machine bus             | Control via:<br>Schneider Electric or third-party PLCs via communication buses and networks                                  |
| <b>Type of servo drive</b>  |  | <b>LXM 32C</b>  | <b>LXM 32A</b>  | <b>LXM 32M</b>   |



### Main functions

|                                |           |  |   |
|--------------------------------|-----------|--|---|
| <b>Application type</b>        |           | High load, With robust adjustment of the movement  | High dynamic range, Power density   |
| <b>Flange size</b>             |           | 70, 100, 140 and 190 mm  | 55, 70, 100 and 140 mm  |
| <b>Continuous stall torque</b> |           | 1.2 to 84 Nm   | 0.5 to 33.4 Nm  |
| <b>Encoder type</b>            |           | Single turn SinCos: 32,768 points/turn and 131,072 points/turn<br>Multiturn SinCos: 32,768 points/turn x 4096 turns and 131,072 points/turn x 4096 turns | Single turn SinCos: 131,072 points/turn<br>Multiturn SinCos: 131,072 points/turn x 4096 turns |
| <b>Degree of protection</b>    | Casing    | IP 65 (IP 67 conformity kit as an option)  |   |
|                                | Shaft end | IP 50 or IP 65 (IP 67 conformity kit as an option)   |   |
| <b>Type of servo motor</b>     |           | <b>Lexium BMH</b>  | <b>Lexium BSH</b>   |



### Lexium 32 servo drive/BMH or BSH servo motor combinations

| Servo motors                |                   |                     |                   | Lexium 32C, 32A and 32M servo drives |               |               |               |
|-----------------------------|-------------------|---------------------|-------------------|--------------------------------------|---------------|---------------|---------------|
| BMH<br>(IP50, IP65 or IP67) |                   |                     |                   | BSH<br>(IP50, IP65 or IP67)          |               |               |               |
|                             |                   |                     |                   | Lexium 32U90M2                       |               |               |               |
|                             |                   |                     |                   | Continuous output current: 3 A rms   |               |               |               |
|                             |                   |                     |                   | Nominal operating point              |               |               | Stall torques |
| Type of servo motor         | Rotor inertia     | Type of servo motor | Rotor inertia     | Nominal torque                       | Nominal speed | Nominal power | $M_0/M_{max}$ |
|                             | kgcm <sup>2</sup> |                     | kgcm <sup>2</sup> | Nm                                   | rpm           | W             | Nm/Nm         |
|                             |                   | BSH 0551T           | 0.06              | 0.49                                 | 3000          | 150           | 0.5/1.5       |
|                             |                   | BSH 0552T           | 0.10              | 0.77                                 | 3000          | 250           | 0.8/1.9       |
|                             |                   | BSH 0553T           | 0.13              |                                      |               |               |               |
| BMH 0701T                   | 0.59              |                     |                   |                                      |               |               |               |
|                             |                   | BSH 0701T           | 0.25              |                                      |               |               |               |
|                             |                   | BSH 0702T           | 0.41              |                                      |               |               |               |
| BMH 0702T                   | 1.13              |                     |                   |                                      |               |               |               |
| BMH 0703T                   | 1.67              |                     |                   |                                      |               |               |               |
|                             |                   | BSH 1001T           | 1.40              |                                      |               |               |               |
| BMH1001T                    | 3.2               |                     |                   |                                      |               |               |               |
| BMH1002T                    | 6.3               |                     |                   |                                      |               |               |               |



### Lexium 32 servo drive/BMH or BSH servo motor combinations

| Servo motors                |                   |                     |                   | Lexium 32C, 32A and 32M servo drives |               |               |               |
|-----------------------------|-------------------|---------------------|-------------------|--------------------------------------|---------------|---------------|---------------|
| BMH<br>(IP50, IP65 or IP67) |                   |                     |                   | BSH<br>(IP 50, IP65 or IP67)         |               |               |               |
|                             |                   |                     |                   | Lexium 32U45M2                       |               |               |               |
|                             |                   |                     |                   | Continuous output current: 1.5 A rms |               |               |               |
|                             |                   |                     |                   | Nominal operating point              |               |               | Stall torques |
| Type of servo motor         | Rotor inertia     | Type of servo motor | Rotor inertia     | Nominal torque                       | Nominal speed | Nominal power | $M_0/M_{max}$ |
|                             | kgcm <sup>2</sup> |                     | kgcm <sup>2</sup> | Nm                                   | rpm           | W             | Nm/Nm         |
|                             |                   | BSH 0551T           | 0.06              | 0.45                                 | 6000          | 300           | 0.5/1.4       |
|                             |                   | BSH 0552T           | 0.10              |                                      |               |               |               |
|                             |                   | BSH 0553T           | 0.13              |                                      |               |               |               |
|                             |                   | BSH 0701T           | 0.25              |                                      |               |               |               |
| BMH 0701T                   | 0.59              |                     |                   |                                      |               |               |               |
|                             |                   | BSH 0702T           | 0.41              |                                      |               |               |               |
|                             |                   | BSH 0703T           | 0.58              |                                      |               |               |               |
| BMH 0702T                   | 1.13              |                     |                   |                                      |               |               |               |
|                             |                   | BSH 1001T           | 1.40              |                                      |               |               |               |
| BMH 0703T                   | 1.67              |                     |                   |                                      |               |               |               |
| BMH 1001T                   | 3.2               |                     |                   |                                      |               |               |               |
|                             |                   | BSH 1002T           | 2.31              |                                      |               |               |               |
| BMH 1002T                   | 6.3               |                     |                   |                                      |               |               |               |
| BMH 1003T                   | 9.4               |                     |                   |                                      |               |               |               |
| BMH 1401P                   | 16.5              |                     |                   |                                      |               |               |               |

| LXM 32●U18M2<br>Continuous output current: 6 A rms |               |               |               | LXM 32●D30M2<br>Continuous output current: 10 A rms |               |               |               |
|--|---------------|---------------|---------------|---|---------------|---------------|---------------|
| Nominal operating point                            |               |               | Stall torques | Nominal operating point                             |               |               | Stall torques |
| Nominal torque                                     | Nominal speed | Nominal power | $M_0/M_{max}$ | Nominal torque                                      | Nominal speed | Nominal power | $M_0/M_{max}$ |
| Nm   | rpm           | W             | Nm/Nm         | Nm  | rpm           | W             | Nm/Nm         |
| 1.14   | 3000          | 350           | 1.2/3.3       |   |               |               |               |
| 1.35   | 2500          | 350           | 1.4/4.2       |   |               |               |               |
| 1.36   | 2500          | 350           | 1.4/3.5       |   |               |               |               |
|  |               |               |               | 2.07  | 2500          | 550           | 2.2/6.1       |
|  |               |               |               | 2.3   | 2500          | 600           | 2.5/6.4       |
|  |               |               |               | 3.1   | 2000          | 650           | 3.4/8.7       |
|  |               |               |               | 2.75  | 2500          | 700           | 3.3/6.3       |
|  |               |               |               | 3.3   | 2000          | 700           | 3.4/8.9       |
|  |               |               |               | 3.5   | 2000          | 750           | 6/10.3        |

| LXM 32●U90 M2<br>Continuous output current: 3 A rms |               |               |               | LXM 32●D18M2<br>Continuous output current: 6 A rms |               |               |               | LXM 32●D30M2<br>Continuous output current: 10 A rms |               |               |               |
|---|---------------|---------------|---------------|--|---------------|---------------|---------------|---|---------------|---------------|---------------|
| Nominal operating point                             |               |               | Stall torques | Nominal operating point                            |               |               | Stall torques | Nominal operating point                             |               |               | Stall torques |
| Nominal torque                                      | Nominal speed | Nominal power | $M_0/M_{max}$ | Nominal torque                                     | Nominal speed | Nominal power | $M_0/M_{max}$ | Nominal torque                                      | Nominal speed | Nominal power | $M_0/M_{max}$ |
| Nm  | rpm           | W             | Nm/Nm         | Nm   | rpm           | W             | Nm/Nm         | Nm  | rpm           | W             | Nm/Nm         |
| 0.74  | 6000          | 450           | 0.8/2.5       |  |               |               |               |   |               |               |               |
| 0.84  | 6000          | 550           | 1.2/3         |  |               |               |               |   |               |               |               |
| 0.94  | 5000          | 500           | 1.3/3.5       |  |               |               |               |   |               |               |               |
| 1.1   | 4000          | 450           | 1.4/4         |  |               |               |               |   |               |               |               |
|   |               |               |               | 1.8  | 5000          | 950           | 2.2/7.2       |   |               |               |               |
|   |               |               |               | 2.1  | 4000          | 900           | 2.6/7.4       |   |               |               |               |
|   |               |               |               | 2.1  | 4000          | 900           | 2.5/7.4       |   |               |               |               |
|   |               |               |               | 2.2  | 4000          | 900           | 2.7/7.5       |   |               |               |               |
|   |               |               |               | 2.9  | 3000          | 900           | 3.4/10.2      |   |               |               |               |
|   |               |               |               | 2.8  | 3000          | 900           | 3.4/10.2      |   |               |               |               |
|   |               |               |               |  |               |               |               | 3.7   | 4000          | 1500          | 5.8/16.4      |
|   |               |               |               |  |               |               |               | 4.6   | 3000          | 1450          | 6/18.4        |
|   |               |               |               |  |               |               |               | 5.6   | 2500          | 1450          | 8.2/22.8      |
|   |               |               |               |  |               |               |               | 6.9   | 2000          | 1450          | 10.3/30.8     |



## Lexium 32 servo drive/BMH or BSH servo motor combinations

Servo motors

Lexium 32C, 32A and 32M servo drives

380...480 V three-phase supply voltage with integrated EMC filter

**BMH**  
(IP50, IP65 or IP67)

**BSH**  
(IP50, IP 65 or IP67)

**LXM 32●U60N4**

**LXM 32●D12N4**

Continuous output current: 1.5 A rms

Continuous output current: 3 A rms

Nominal operating point

Stall torques

Nominal operating point

Stall torques

| Type of servo motor | Rotor inertia     | Type of servo motor | Rotor inertia | Nominal torque | Nominal speed | Nominal power | M <sub>0</sub> /M <sub>max</sub> | Nominal torque | Nominal speed | Nominal power | M <sub>0</sub> /M <sub>max</sub> |
|---------------------|-------------------|---------------------|---------------|----------------|---------------|---------------|----------------------------------|----------------|---------------|---------------|----------------------------------|
|                     | kgcm <sup>2</sup> |                     |               |                |               |               |                                  |                |               |               |                                  |
|                     |                   | BSH 0551P           | 0.06          | 0.48           | 6000          | 300           | 0.5/1.5                          |                |               |               |                                  |
|                     |                   | BSH 0552P           | 0.10          | 0.65           | 6000          | 400           | 0.8/2.5                          |                |               |               |                                  |
|                     |                   | BSH 0553P           | 0.13          | 0.65           | 6000          | 400           | 1.05/3.5                         |                |               |               |                                  |
| BMH 0701P           | 0.59              |                     |               | 1.1            | 3000          | 350           | 1.2/4.2                          |                |               |               |                                  |
| BMH 0701P           | 0.59              |                     |               |                |               |               |                                  | 1.3            | 5000          | 700           | 1.4/4.2                          |
|                     |                   | BSH 0701P           | 0.25          |                |               |               |                                  | 1.32           | 5000          | 700           | 1.4/3.5                          |
|                     |                   | BSH 0702P           | 0.41          |                |               |               |                                  | 1.64           | 5000          | 850           | 2.2/7.6                          |
| BMH 1001P           | 3.2               |                     |               |                |               |               |                                  | 1.9            | 4000          | 800           | 3.3/10.8                         |
| BMH 0702P           | 1.13              |                     |               |                |               |               |                                  | 2.2            | 3000          | 700           | 2.5/7.4                          |
| BMH 0703P           | 1.67              |                     |               |                |               |               |                                  |                |               |               |                                  |
|                     |                   | BSH 0703P           | 0.58          |                |               |               |                                  |                |               |               |                                  |
|                     |                   | BSH 1001P           | 1.40          |                |               |               |                                  |                |               |               |                                  |
| BMH 1001P           | 3.2               |                     |               |                |               |               |                                  |                |               |               |                                  |
| BMH 1002P           | 6.3               |                     |               |                |               |               |                                  |                |               |               |                                  |
|                     |                   | BSH 1002P           | 2.31          |                |               |               |                                  |                |               |               |                                  |
| BMH 1003P           | 9.4               |                     |               |                |               |               |                                  |                |               |               |                                  |
|                     |                   | BSH 1003P           | 3.2           |                |               |               |                                  |                |               |               |                                  |
| BMH 1401P           | 16.5              |                     |               |                |               |               |                                  |                |               |               |                                  |
|                     |                   | BSH 1004P           | 4.2           |                |               |               |                                  |                |               |               |                                  |
|                     |                   | BSH 1401P           | 7.4           |                |               |               |                                  |                |               |               |                                  |
| BMH 1402P           | 32.0              |                     |               |                |               |               |                                  |                |               |               |                                  |
|                     |                   | BSH 1402T           | 12.7          |                |               |               |                                  |                |               |               |                                  |
|                     |                   | BSH 1403T           | 17.9          |                |               |               |                                  |                |               |               |                                  |
| BMH 1403P           | 47.5              |                     |               |                |               |               |                                  |                |               |               |                                  |
|                     |                   | BSH 1404P           | 23.7          |                |               |               |                                  |                |               |               |                                  |
| BMH 1901P           | 67.7              |                     |               |                |               |               |                                  |                |               |               |                                  |
| BMH 1902P           | 130               |                     |               |                |               |               |                                  |                |               |               |                                  |
| BMH 1903P           | 194               |                     |               |                |               |               |                                  |                |               |               |                                  |

| LXM 32●D18N4<br>Continuous output current: 6 A rms |               |               |                                  | LXM 32●D30N4<br>Continuous output current: 10 A rms |               |               |                                  | LXM 32●D72N4<br>Continuous output current: 24 A rms |               |               |                                  |
|--|---------------|---------------|----------------------------------|---|---------------|---------------|----------------------------------|---|---------------|---------------|----------------------------------|
| Nominal operating point                            |               |               | Stall torques                    | Nominal operating point                             |               |               | Stall torques                    | Nominal operating point                             |               |               | Stall torques                    |
| Nominal torque                                     | Nominal speed | Nominal power | M <sub>0</sub> /M <sub>max</sub> | Nominal torque                                      | Nominal speed | Nominal power | M <sub>0</sub> /M <sub>max</sub> | Nominal torque                                      | Nominal speed | Nominal power | M <sub>0</sub> /M <sub>max</sub> |
| Nm   | rpm           | W             | Nm/Nm                            | Nm  | rpm           | W             | Nm/Nm                            | Nm  | rpm           | W             | Nm/Nm                            |
| 2.4  | 5000          | 1300          | 3.4/10.2                         |   |               |               |                                  |   |               |               |                                  |
| 2.44   | 5000          | 1300          | 3.1/11.3                         |   |               |               |                                  |   |               |               |                                  |
| 2.7  | 4000          | 1100          | 3.3/9.6                          |   |               |               |                                  |   |               |               |                                  |
| 3.1  | 4000          | 1300          | 3.4/10.2                         |   |               |               |                                  |   |               |               |                                  |
| 3.9  | 4000          | 1600          | 6.2/18.4                         |   |               |               |                                  |   |               |               |                                  |
| 4  | 4000          | 1700          | 5.8/18.3                         |   |               |               |                                  |   |               |               |                                  |
|  |               |               |                                  | 6.2   | 4000          | 2600          | 8.4/25.1                         |   |               |               |                                  |
|  |               |               |                                  | 6.3   | 3000          | 2000          | 8/28.3                           |   |               |               |                                  |
|  |               |               |                                  | 7.6   | 3000          | 2400          | 10.3/30.8                        |   |               |               |                                  |
|  |               |               |                                  | 8.3   | 2500          | 2100          | 10/37.9                          |   |               |               |                                  |
|  |               |               |                                  | 9.5   | 2500          | 2500          | 11.1/27                          |   |               |               |                                  |
|  |               |               |                                  |   |               |               |                                  | 12.1  | 3000          | 3800          | 16.8/50.3                        |
|  |               |               |                                  |   |               |               |                                  | 12.3  | 3000          | 3900          | 19.5/59.3                        |
|  |               |               |                                  |   |               |               |                                  | 12.9  | 3000          | 4100          | 27.8/90.2                        |
|  |               |               |                                  |   |               |               |                                  | 14.2  | 3000          | 4500          | 24/71.8                          |
|  |               |               |                                  |   |               |               |                                  | 19  | 2500          | 5000          | 33.4/103.6                       |
|  |               |               |                                  |   |               |               |                                  | 18.4  | 2 500         | 4 800         | 30/77.7                          |
|  |               |               |                                  |   |               |               |                                  | 22.3  | 2 500         | 5 900         | 37.4/101                         |
|  |               |               |                                  |   |               |               |                                  | 36  | 1 500         | 5 700         | 43.2/123                         |



### Multi-Loader configuration tool

**Use**

For downloading configurations from a PC or drive and duplicating them on another drive. The drives do not need to be powered-up.  
Supplied with:  
1 cordset equipped with 2 RJ45 connectors  
1 cordset equipped with one type A USB connector and one mini B USB connector  
1 x 2 GB SD memory card  
1 x female/female RJ 45 adaptor  
4 AA 1.5 V LR6 round batteries

**Reference** **VW3 A8 121**



### Single memory card

### Pack of 25 memory cards

**Use**

Used to store parameters of the Lexium 32 servo drive. Another Lexium 32 servo drive can be commissioned immediately if the application is undergoing maintenance or duplication.

**Reference** **VW3 M8 705** **VW3 M8 704**

### Memory card recorder

**Use**

Writes data from the Lexium 32 servo drive to the memory card. This recorder is not supplied by Schneider Electric.

**Reference** See the User's manual

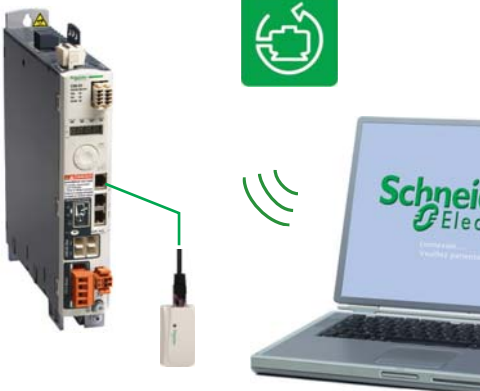

### SoMove setup software

The SoMove setup software is used to configure, adjust, debug and maintain the Lexium 32 servo drive, as for all other Schneider Electric variable speed drives and starters. It communicates via Bluetooth® wireless link with the servo drive, which is equipped with the Modbus-Bluetooth® adaptor (VW3 A8 114).

### SoMove Mobile application for mobile phone

The SoMove Mobile software converts any compatible mobile phone into a remote graphic display terminal, offering an identical Human-Machine Interface. Particularly suitable for on-site or remote maintenance operations, the SoMove Mobile software can be used to print out and save configurations, import them from a PC and export them to a PC, or to a servo drive equipped with the Modbus adaptor via the Bluetooth® wireless link.





## Communication modules

Lexium 32M can be connected to the following communication buses and networks: CANopen and CANmotion, DeviceNet, Profibus DP V1, EtherNet/IP, I/O module

| Reference | Description   | Part Number |
|-----------|---|-------------|
|           | CANopen / CANmotion module with 2 * RJ 45 connectors      | VW3 A3 608  |
|           | CANopen / CANmotion module with SUB-D 9 connector         | VW3 A3 618  |
|           | DeviceNet module  | VW3 M3 301  |
|           | Profibus DP V1 module                                     | VW3 A3 607  |
|           | EtherNet/IP module  | VW3 A3 616  |
|           | Module CANopen / CANmotion one 5-way screw terminal block | VW3 A3 628  |
|           | Module EtherCAT with 2 RJ45 connectors                    | VW3 A3 601  |
|           | I/O module with 4DI, 2DO, 2AI, 2AO                        | VW3 M3 302  |



## Second encoder modules

Lexium 32M has an input for an additional encoder to connect third party motor (motor encoder) or to improve positioning accuracy (machine encoder)

| Reference | Description   | Machine            | Motor |
|-----------|---|--------------------|-------|
|           | Module for resolver encoder                               |                    | x     |
|           | Module for digital encoder (A/B/I, BiSS, EndDat 2.2, SSI) | x                  |       |
|           | Module for analog encoder (1 Vpp/Hall, 1 Vpp, Hiperface)  | x (Hiperface only) | x     |



## Safety module

eSM safety module allows Lexium 32M servo drives to access additional IEC/EN 61800-5-2 safety functions: SS1, SS2, SLS, SOS

| Reference | Description              | Part Number |
|-----------|--------------------------|-------------|
|           | eSM safety module allows | VW3 M3 501  |

## Connection elements

### Power cordsets

| Description      | Cables equipped with one M23 industrial connector (servo motor end)         |   | Cables equipped with one M40 industrial connector (servo motor end) |   |
|------------------|---|---|---|---|
| From servo motor | BMH 070●●, BMH 100●●, BMH 1401P, BSH 055●●, BSH 070●●, BSH 100●●, BSH 1401P | BMH 1402P, BMH 1403P                                    | BMH 1901P, BSH 1402T, BSH 1403T, BSH 1404P                          | BMH 1902P, BMH 1903P                                  |
| To servo drive   | LXM 32●●●●●●  | LXM 32●D72N4  | LXM 32●D72N4  | LXM32.D72N4   |
| Composition      | [[4 x 1.5 mm <sup>2</sup> ] + (2 x 1 mm <sup>2</sup> )]                     | [[4 x 2.5 mm <sup>2</sup> ] + (2 x 1 mm <sup>2</sup> )] | [[4 x 4 mm <sup>2</sup> ] + (2 x 1 mm <sup>2</sup> )]               | [[4 x 6 mm <sup>2</sup> ] + (2 x 1 mm <sup>2</sup> )] |
| Length           | 3 m   | 3 m   | 3 m   | 3 m   |
| Reference        | <b>VW3 M5 101 R30</b>   | <b>VW3 M5 102 R30</b>                                   | <b>VW3 M5 103 R30</b>   | <b>VW3 M5 105 R30</b>                                 |

### Encoder cordsets

|                  |   |
|------------------|---|
| Description      | <b>SinCos Hiperface® encoder cables equipped with an M23 industrial connector (servo motor end) and an RJ45 connector with 8 + 2 contacts (servo drive end)</b> |
| From servo motor | BMH ●●●●●, BSH ●●●●●  |
| To servo drive   | LXM 32●●●●●●  |
| Composition      | [3 x (2 x 0.14 mm <sup>2</sup> ) + (2 x 0.34 mm <sup>2</sup> )]   |
| Length           | 3 m   |
| Reference        | <b>VW3 M8 102 R30</b>   |



### Assignment of BRS2 2-phase stepper motors and SD2 stepper motor drives

| BRS2 2-phase stepper motors | SD21●●U20C     | SD21●●U50C     |
|-----------------------------|----------------|----------------|
|                             | 24...48 V; 3 A | 24...48 V; 5 A |
| BRS236                      | 0.07 Nm        | –              |
| BRS242                      | 0.23...0.53 Nm | –              |
| BRS257                      | 0.64...1.69 Nm | 0.64...1.69 Nm |
| BRS285                      | –              | 2.96...9.20 Nm |

3



### Assignment of BRS3 3-phase stepper motors and SD3 stepper motor drives

| BRS3 3-phase stepper motors | SD326●U25                                    | SD328●U25 | SD326●U68  | SD328●U68 |
|-----------------------------|--|-----------|--|-----------|
|                             | 115 V / 230 V; 2.5 A; including mains filter |           | 115 V / 230 V; 6.8 A; including mains filter and fan |           |
| BRS368                      | 1.7 Nm / 1.5 Nm                              |           | –  |           |
| BRS397                      | 2.3 Nm / 2.0 Nm                              |           | –  |           |
| BRS39A                      | 4.5 Nm / 4.0 Nm                              |           | –  |           |
| BRS39B                      | 6.8 Nm / 6.0 Nm                              |           | –  |           |
| BRS3AC                      | –  |           | 13.5 Nm / 12.0 Nm                                    |           |
| BRS3AD                      | –  |           | 19.7 Nm / 16.5 Nm                                    |           |



### Assignment of stepper motors, stepper motor drives SD3 15

| 3-phase stepper motors       | SD3 15                 |
|------------------------------|------------------------|
|                              | 24...48 VDC; max. 10 A |
| <b>Motors with F winding</b> |                        |
| BRS 364F                     | 0.46 Nm / 0.40 Nm      |
| BRS 366F                     | 0.92 Nm / 0.80 Nm      |
| BRS 368F                     | 1.50 Nm / 1.30 Nm      |
| BRS 397F                     | 2.00 Nm / 1.85 Nm      |
| BRS 39AF                     | 4.20 Nm / 3.40 Nm      |
| BRS 39BF                     | 5.55 Nm / 4.80 Nm      |
| <b>Motors with H winding</b> |                        |
| BRS 364H                     | 0.51 Nm / 0.45 Nm      |
| BRS 366H                     | 1.02 Nm / 0.90 Nm      |
| BRS 368H                     | 1.70 Nm / 1.50 Nm      |
| BRS 397H                     | 2.26 Nm / 2.00 Nm      |
| BRS 39AH                     | 4.80 Nm / 4.00 Nm      |
| BRS 39BH                     | 6.50 Nm / 5.75 Nm      |



| Integrated Drives               |                             | Lexium ILA  | Lexium ILE  | Lexium ILS   | Lexium ILP / ILT  |
|---------------------------------|-----------------------------|---|---|--|---|
| <b>Type of process</b>          |                             | Dynamic process and accurate positioning  | Automatic format adjustment                                       | Short distance movements with accurate positioning |   |
| <b>Type of technology</b>       |                             | Integrated drive with servo motor   | Integrated drive with dc brushless motor                          | Integrated drive with three-phase stepper motor    | Integrated drive with two-phase stepper motor                 |
| <b>Main characteristics</b>     |                             | Highly dynamic<br>Compact<br>Integrated holding brake in option   | High holding torque without power<br>Integrated gearbox in option | High torque at low speed                           |   |
| <b>Dynamic</b>                  |                             | ★★★★  | ★★  | ★★★  | ★★★   |
| <b>Precision and stability</b>  |                             | ★★★★  | ★★  | ★★★★   | ★★★★  |
| <b>Energy saving</b>            |                             | ★★★★★   | ★★★★  | ★★   | ★★  |
| <b>Motor inertia</b>            |                             | Medium  |   |  |   |
| <b>Control interface</b>        | Control signals             | Input/output  |   | Pulse/direction<br>Input/output                    | Pulse/direction<br>Input/output                               |
|                                 | Bus and networks            | CANopen, PROFIBUS DP, RS 485 serial link, DeviceNet, EtherCAT, Modbus TCP, Ethernet Powerlink, EtherNet/IP            |   |  | CANopen, RS485  |
|                                 | Motion bus                  | -   |   |  |   |
| <b>Association</b>              | Nominal power               | 150...305W  | 100...350W  | 100...350W   | 150 - 305 W   |
| <b>Drive/motor combinations</b> | Nominal speed               | 500...9000 rpm  | 1500...7000 rpm   | 0...1000 rpm                                       | 0...2000 rpm  |
| <b>Drive characteristics</b>    | Nominal torque              | 0.26...0.78 Nm  | 0.18...0.5 Nm   | 0.45...6 Nm  | 0.11...5.87 Nm  |
| <b>Power Supply</b>             | Safety function             | "Safe Torque Off"   |   |  |   |
| <b>Motor characteristics</b>    | Type of sensor (resolution) | Single turn SinCos encoder (16,384 increments/turn)<br>Multiturn SinCos encoder (16,384 increments/turn × 4096 turns) | Absolute value encoder (12...1380 increments/turn)                | Index pulse monitoring                             |   |
|                                 | Motor flange size           | 57  | 66  | 57, 85   | 36, 42, 57, 85  |
| <b>Accessories</b>              |                             | Cable, Connector kits, Installation sets, Commissioning tools, Planetary gearboxes                                    |   |  | Cable, Connector kits, Installation sets, Commissioning tools |
| <b>References</b>               |                             | ILA   | ILE   | ILS  | ILP   ILT   |



| Lexium ILA with Servo Motor  | Nominal Torque (Nm) | Maximum Torque (Nm) | Nominal Speed (Rpm) | Maximum Speed (Rpm) | Nominal Power (W) |
|--|---------------------|---------------------|---------------------|---------------------|-------------------|
| <b>ILA1 for CANopen, PROFIBUS DP, RS485</b>                                      |                     |                     |                     |                     |                   |
| ILA1●571P  | 0.26                | 0.6                 | 5500                | 7500                | 150               |
| ILA1●571T  | 0.26                | 0.43                | 7500                | 11500               | 200               |
| ILA1●572P  | 0.45                | 0.72                | 4300                | 6200                | 200               |
| ILA1●572T  | 0.41                | 0.61                | 5000                | 7500                | 215               |
| <b>ILA2 for DeviceNet, EtherCAT, EtherNet/IP, Modbus TCP, Ethernet Powerlink</b> |                     |                     |                     |                     |                   |
| ILA2●571P  | 0.44                | 0.62                | 5100                | 7000                | 235               |
| ILA2●571T  | 0.31                | 0.45                | 7000                | 9000                | 255               |
| ILA2●572P  | 0.78                | 1.62                | 3400                | 4300                | 275               |
| ILA2●572T  | 0.57                | 0.85                | 5100                | 6800                | 305               |



Lexium ILE with included spurwheel gearbox.

Ratios: 18:1, 38:1, 54:1, 115:1

Lexium ILE with included worm gearbox with hollow shaft.

Ratios: 24:1, 54:1, 92:1, 115:1

| Lexium ILE with Brushless DC Motor   | Nominal Torque (Nm) | Detent Torque (Nm) | Nominal Speed (Rpm) | Maximum Speed (Rpm) |
|--|---------------------|--------------------|---------------------|---------------------|
| <b>ILE1 for CANopen, PROFIBUS DP, RS485</b>                                      |                     |                    |                     |                     |
| ILE1●661   | 0.24                | 0.08               | 4800                | 5000                |
| ILE1●661 spurwheel gearing   | up to 11.0          | up to 8.0          | 44                  | 44                  |
| ILE1●661 worm gearing  | up to 10.6          | up to 16.7         | 44                  | 44                  |
| <b>ILE2 for DeviceNet, EtherCAT, EtherNet/IP, Modbus TCP, Ethernet Powerlink</b> |                     |                    |                     |                     |
| ILE2●661   | 0.26                | 0.08               | 6000                | 7000                |
| ILE2●661 spurwheel gearing   | up to 12            | up to 9.19         | 44                  | 44                  |
| ILE2●661 worm gearing  | up to 10.6          | up to 16.7         | 44                  | 44                  |
| ILE2●662   | 0.5                 | 0.106              | 5000                | 7000                |



| Lexium ILS with three-phase Stepper Motor  | Maximum Torque (Nm) | Holding Torque (Nm) | Speed (Rpm) |
|--|---------------------|---------------------|-------------|
| <b>ILS1 for CANopen, PROFIBUS DP, RS485, Pulse-Direction, Motion Sequence Mode</b> |                     |                     |             |
| ILS1●571●  | 0.45                | 0.51                | 1000        |
| ILS1●572●  | 0.9                 | 1.02                | 600         |
| ILS1●573●  | 1.5                 | 1.7                 | 450         |
| ILS1●851●  | 2.0                 | 2.0                 | 450         |
| ILS1●852●  | 4.0                 | 4.0                 | 200         |
| ILS1●853P  | 6.0                 | 6.0                 | 120         |
| ILS1●853T  | 4.5                 | 4.5                 | 300         |
| <b>ILS2 for DeviceNet, EtherCAT, EtherNet/IP, Modbus TCP, Ethernet Powerlink</b>   |                     |                     |             |
| ILS2●571●  | 0.45                | 0.51                | 1100        |
| ILS2●572●  | 0.9                 | 1.02                | 900         |
| ILS2●573●  | 1.5                 | 1.7                 | 600         |
| ILS2●851●  | 2.0                 | 2.0                 | 600         |
| ILS2●852●  | 4.0                 | 4.0                 | 380         |
| ILS2●853P  | 6.0                 | 6.0                 | 200         |
| ILS2●853T  | 4.5                 | 4.5                 | 300         |

# Lexium ILP/ILT Motion Control Lexium Integrated Drives



| Lexium ILP, Lexium ILT with two-phase Stepper Motor | Nominal Torque (Nm) | Holding Torque (Nm) | Maximum Speed (Rpm) |
|---|---------------------|---------------------|---------------------|
| <b>ILP for RS485 with programmable interface</b>    |                     |                     |                     |
| ILP2R361  | 0.11                | 0.11                | 1800                |
| ILP2R421  | 0.19                | 0.19                | 1500                |
| ILP2R422  | 0.33                | 0.33                | 1500                |
| ILP2R423  | 0.39                | 0.39                | 1500                |
| ILP2R571  | 0.63                | 0.63                | 1500                |
| ILP2R572  | 0.86                | 0.86                | 1500                |
| ILP2R573  | 1.44                | 1.44                | 1500                |
| ILP2R574  | 1.77                | 1.77                | 1500                |
| ILP2R851  | 2.13                | 2.13                | 1000                |
| ILP2R852  | 3.12                | 3.12                | 1000                |
| ILP2R853  | 5.87                | 5.87                | 1000                |
| <b>ILT for Pulse/Direction, CANopen</b>             |                     |                     |                     |
| ILT2●361  | 0.11                | 0.11                | 1800                |
| ILT2●421  | 0.19                | 0.19                | 1500                |
| ILT2●422  | 0.33                | 0.33                | 1500                |
| ILT2●423  | 0.39                | 0.39                | 1500                |
| ILT2●571  | 0.63                | 0.63                | 1500                |
| ILT2●572  | 0.86                | 0.86                | 1500                |
| ILT2●573  | 1.44                | 1.44                | 1500                |
| ILT2●574  | 1.77                | 1.77                | 1500                |
| ILT2●851  | 2.13                | 2.13                | 1000                |
| ILT2●852  | 3.12                | 3.12                | 1000                |
| ILT2●853  | 5.87                | 5.87                | 1000                |

# Lexium Linear Motion Motion Control Linear axes



| Product                               |                      | Lexium PAS B   | Lexium PAS S  |
|---------------------------------------|----------------------|--|---|
| Axis type                             |                      | Portal axes  |   |
| Movement                              | Number of directions | 1  |   |
|                                       | Movement type        | Typically horizontal   |   |
|                                       | Position of the load | On carriage  |   |
| Drive                                 |                      | Toothed belt   | Ballscrew   |
| Type of guide                         |                      | Ball or roller   | Ball  |
| Main characteristics                  |                      | High dynamic response, Long stroke length, High positioning speed  | High precision movement (positioning, repeatability, guiding), High feed forces, High rigidity  |
| Dynamic response                      |                      | ★★★★★  | ★★★   |
| Precision                             |                      | ★★★  | ★★★★★   |
| Maximum payload                       |                      | 100 kg   | 100 kg  |
| Maximum driving force                 |                      | 2600 N   | 4520 N  |
| Maximum speed of movement of the load |                      | 8 m/s  | 1.25 m/s  |
| Maximum working stroke                |                      | 5500 mm  | 3000 mm   |
| Repeatability                         |                      | ± 0.05 mm  | ± 0.02 mm   |
| Options                               |                      | Choice of guide type: Ball (for applications requiring high forces and torques) or roller (simple, cost-effective solution), Wide range of sensors, Choice of carriage type for adapting to the load, Option to add carriages, Protective metal strip. | Choice of pitch, Protective metal strip, Wide range of sensors, Choice of carriage type for adapting to the load, Option to add carriages, Option to add ballscrew supports for longer axes |
| Reference                             |                      | PAS 4●B  | PAS 4●S   |

## Multi-axis systems



| Product                |                      | Lexium MAX H   | Lexium MAX S   |
|------------------------|----------------------|--|--|
| Axis type              |                      | Double portal axes   |  |
| Movement               | Number of directions | 1  |  |
|                        | Movement type        | Combination of two parallel axes   |  |
|                        | Position of the load | On two parallel carriages  |  |
| Multi-axis system type |                      | PAS 4●B axes + PAS 4●H support axis (driven by the load)   | PAS 4●B + PAS 4●B axes (shaft-driven)  |
| Drive                  |                      | Toothed belt on one axis   | Toothed belt on both axes  |
| Type of guide          |                      | Ball or roller   | Ball or roller   |
| Main characteristics   |                      | Long stroke length, High dynamic response, High precision movement (positioning, guiding)  | Long stroke length, High precision movement (positioning, guiding), High feed forces |
| Maximum payload        |                      | 250 kg   | 300 kg   |
| Maximum working stroke | On the X-axis        | 5500 mm  |  |
|                        | On the Y-axis        | –  |  |
|                        | On the Z-axis        | –  |  |
| Options                |                      | Choice of guide type: Ball (for applications requiring high forces and torques) or roller (simple, cost-effective solution), Protective metal strip, Anti-corrosion version, Anti-static belt, Wide range of sensors, Several different motor mounting options, Variable distance between the two axes |  |
| Reference              |                      | MAX H  | MAX S  |



| Lexium TAS  | Lexium CAS 4   | Lexium CAS 3   | Lexium CAS 2  |
|---|--|--|---|
| Linear tables   | Cantilever axes with mobile structure on profile   | Cantilever axes with mobile structure on parallel rods | Telescopic axes   |
| 1   |  |  |   |
| Typically horizontal  | Typically vertical   |  | Typically horizontal  |
| On carriage   | On the side of the profile or on the 2 end blocks  | On the 2 end blocks                                    | On carriage   |
| Ballscrew   | Toothed belt   | Toothed belt or rack                                   | Toothed belt  |
| Double, ball  | Ball or roller   | Ball   | Ball or roller  |
| High precision movement (positioning, repeatability, guiding), High feed forces, High rigidity, Feed movement without mechanical backlash | Long stroke length, High feed forces, Option to mount the load on the side of the profile or on the end blocks, High rigidity  | Compact, Mobile structure with light travel weight     | Long stroke length from a compact unit, High rigidity, High dynamic response  |
| ★★  | ★★★★   | ★★★★   | ★★★★  |
| ★★★★★   | ★★★  | ★★★  | ★★  |
| 150 kg  | 50 kg  | 18 kg  | 35 kg   |
| 2580 N  | 2150 N   | 705 N  | 1500 N  |
| 1 m/s   | 3 m/s  | 3 m/s  | 3 m/s   |
| 1500 mm   | 1200 mm  | 500 mm   | 2400 mm   |
| ± 0.02 mm   | ± 0.05 mm  | ± 0.05 mm  | ± 0.1 mm  |
| Choice of pitch , Several different motor mounting options  | Choice of guide type: Ball (for applications requiring high forces and torques) or roller (simple, cost-effective solution), Protective metal strip, Anti-corrosion version, Wide range of sensors | Anti-corrosion version, Anti-static belt               | Choice of guide type: Ball (for applications requiring high forces and torques) or roller (simple, cost-effective solution), Choice of carriage type for adapting to the load |
| TAS 4   | CAS 4  | CAS 3  | CAS 2   |

3



| Lexium MAX P  | Lexium MAX R2   | Lexium MAX R3   |
|---|---|---|
| Linear positioners  | Portal robots   |   |
| 2   |   | 3   |
| Horizontal and vertical: Combination of one X-axis and one Z-axis   | Horizontal: Combination of two perpendicular axes X and Y | Horizontal and vertical: Combination of two perpendicular axes X and Y and one Z-axis |
| On the side or on the end blocks of the Z-axis profile  | On the Y-axis carriage                                    | On the side or on the end blocks of the Z-axis profile                                |
| MAX S + CAS 4 axes<br>MAX S + CAS 3 axes  | MAX S + MAX H axes<br>MAX S + PAS 4●B axes                | MAX S + MAX H + CAS 4 axes<br>MAX S + MAX H + CAS 3 axes                              |
| Toothed belt on each axis   |   |   |
| Ball or roller  |   |   |
| Dynamic load positioning  | Long stroke length on both axes                           | Long stroke length on three axes  |
| 50 kg   | 130 kg  | 50 kg   |
| 5500 mm   |   |   |
| –   | 1500 mm   | 1500 mm   |
| 1200 mm   | –   | 1200 mm   |
| Choice of guide type: Ball (for applications requiring high forces and torques) or roller (simple, cost-effective solution), Wide range of sensors<br>Supplied as standard: Protective metal strip , Anti-corrosion version |   |   |
| MAX P   | MAX R●2   | MAX R●3   |

# 4

Schneider Electric has been leading the way in the motor starter market for more than 80 years. Its TeSys products offer an extensive range of innovative motor protection and power control solutions.

## TeSys

Protect your machines and installations with TeSys - a comprehensive range of contactors, circuit breakers, starters, motor starters and power control components.





# 4 | Motor control



## Motor control components

|   |              |
|---|--------------|
| <b>TeSys contactors</b> .....                       | 4/2 to 4/11  |
| Contactors, <b>TeSys K, D, F, B</b>                 |              |
| Variable composition contactors, <b>TeSys CV</b>    |              |
| <b>TeSys protection components</b> .....            | 4/12 to 4/33 |
| Thermal-magnetic circuit-breakers                   |              |
| Magnetic circuit-breakers                           |              |
| Fuse carriers, switch-disconnector-fuses            |              |
| Thermal overload relays                             |              |
| Electronic thermal overload relays                  |              |
| Electronic overload relays                          |              |
| Starter-controller, <b>TeSys T</b>                  |              |
| Multifunction protection relays                     |              |
| Switch disconnectors <b>Mini Vario and Vario</b>    |              |
| <b>TeSys starters</b> .....                         | 4/34 to 4/41 |
| Combination motor starters                          |              |
| Starter-controller, <b>TeSys U</b>                  |              |
| Controller, <b>TeSys U</b>                          |              |
| Enclosed motor starters                             |              |
| <b>TeSys installation system</b> .....              | 4/42 to 4/43 |
| For motor starter components with spring terminals, |              |
| <b>TeSys Quickfit</b> technology                    |              |

## Components for power control applications ..... 4/44 to 4/50

Lighting, capacitor switching, heating and changeover contactor pairs



### Connections

#### screw clamp terminals

|                                   |                          |                             |                           |                           |
|-----------------------------------|--------------------------|-----------------------------|---------------------------|---------------------------|
| <b>Rated operational current</b>  | le max AC-3 (Ue ≤ 440 V) | 6 A                         | 9 A                       | 12 A                      |
|                                   | le AC-1 (θ ≤ 40° C)      | -                           | 20 A                      | -                         |
| <b>Rated operational power</b>    | 220/240 V                | 1.5 kW                      | 2.2 kW                    | 3 kW                      |
| <b>in category AC3</b>            | 380/400 V...415/440 V    | 2.2 kW                      | 4 kW                      | 5.5 kW                    |
|                                   | 660/690 V...500 V        | 3 kW                        | 4 kW                      | 4 kW                      |
| <b>Contactor type (1)*</b>        | ~                        | <b>LC1K06**</b>             | <b>LC1K09**</b>           | <b>LC1K12**</b>           |
|                                   | ≡                        | <b>LP1K06** or LP4K06**</b> | <b>LP1K09 or LP4K09**</b> | <b>LP1K12 or LP4K12**</b> |
| <b>Reversing contactor type *</b> | ~                        | <b>LC2K06</b>               | <b>LC2K09</b>             | <b>LC2K12</b>             |
| <b>with mechanical interlock</b>  | ≡                        | <b>LP2K06 or LP5K06</b>     | <b>LP2K09 or LP5K09</b>   | <b>LP2K12 or LP5K12</b>   |

#### spring terminals

Add the figure 3 before the voltage code. Example: **LC1K0610\*\*** becomes **LC1K06103\*\***

#### Faston connectors, 1 x 6.35 or 2 x 2.8

Add the figure 7 before the voltage code. Example: **LC1K0610\*\*** becomes **LC1K06107\*\***

#### solder pins for printed circuit boards

Add the figure 5 before the voltage code. Example: **LC1K0610\*\*** becomes **LC1K06105\*\***

(1) Basic reference, to be completed by adding **01** for NC auxiliary contact, or **10** for NO auxiliary contact.

\* Basic reference to be completed by adding the coil voltage code

### Standard control circuit voltages

#### ~ supply

#### Contactors LC1K (0.8...1.15 Uc) (0.85...1.1 Uc)

|          |           |            |           |           |           |           |           |            |            |            |           |           |           |           |
|----------|-----------|------------|-----------|-----------|-----------|-----------|-----------|------------|------------|------------|-----------|-----------|-----------|-----------|
| Volts    | 12        | 20         | 24        | 36        | 42        | 48        | 110       | 115        | 120        | 127        | 200/208   | 220/230   | 230       | 230/240   |
| 50/60 Hz | <b>J7</b> | <b>Z7</b>  | <b>B7</b> | <b>C7</b> | <b>D7</b> | <b>E7</b> | <b>F7</b> | <b>FE7</b> | <b>G7</b>  | <b>FC7</b> | <b>L7</b> | <b>M7</b> | <b>P7</b> | <b>U7</b> |
| Volts    | 256       | 277        | 380/400   | 400       | 400/415   | 440       | 480       | 500        | 575        | 600        | 660/690   |           |           |           |
| 50/60 Hz | <b>W7</b> | <b>UE7</b> | <b>Q7</b> | <b>V7</b> | <b>N7</b> | <b>R7</b> | <b>T7</b> | <b>S7</b>  | <b>SC7</b> | <b>X7</b>  | <b>Y7</b> |           |           |           |

Example of complete reference: **LC1K0910P7**

#### ≡ supply

#### Contactors LP1K (0.8...1.15 Uc)

|       |           |           |           |           |           |           |           |           |           |           |           |           |           |           |            |            |           |
|-------|-----------|-----------|-----------|-----------|-----------|-----------|-----------|-----------|-----------|-----------|-----------|-----------|-----------|-----------|------------|------------|-----------|
| Volts | 12        | 20        | 24        | 36        | 48        | 60        | 72        | 100       | 110       | 125       | 155       | 174       | 200       | 220       | 230        | 240        | 250       |
| Code  | <b>JD</b> | <b>ZD</b> | <b>BD</b> | <b>CD</b> | <b>ED</b> | <b>ND</b> | <b>SD</b> | <b>KD</b> | <b>FD</b> | <b>GD</b> | <b>PD</b> | <b>QD</b> | <b>LD</b> | <b>MD</b> | <b>MPD</b> | <b>MUD</b> | <b>UD</b> |

Coil with integral suppression device available, add **3** to the code required. Example: **JD3**

#### Low consumption

#### Contactors LP4K (0.7...1.30 Uc), coil suppression as standard

|       |            |            |            |            |            |            |            |
|-------|------------|------------|------------|------------|------------|------------|------------|
| Volts | 12         | 20         | 24         | 48         | 72         | 110        | 120        |
| Code  | <b>JW3</b> | <b>ZW3</b> | <b>BW3</b> | <b>EW3</b> | <b>SW3</b> | <b>FW3</b> | <b>GW3</b> |

Example of complete reference: **LC1K0910BD**



## Auxiliary contact blocks

instantaneous, screw clamp connections

|             | ■ for LC1, LP1K, LP4 |         |         | ■ for LC1, LP1K |         |         |         |         |
|-------------|----------------------|---------|---------|-----------------|---------|---------|---------|---------|
| Composition | 2NO                  | - 2NC   | 1NO 1NC | 4NO             | 3NO 1NC | 2NC 2NC | 1NO 3NC | - 4NC   |
| Reference   | LA1KN20              | LA1KN02 | LA1KN11 | LA1KN40         | LA1KN31 | LA1KN22 | LA1KN13 | LA1KN04 |

### electronic time delay

Relay outputs, with common point changeover contact,  $\sim$  or  $\equiv$  24...48, 2 A maximum

Control voltage 0.85...1.1 U<sub>c</sub>

Maximum switching capacity 250 VA or 150 W

Operating temperature -10...+60°C

Reset time: 1.5 s during the time delay period, 0.5 s after time delay period

|              |                              |                  |
|--------------|------------------------------|------------------|
| Type         | On-delay                     |                  |
| Timing range | 1...30 s                     |                  |
| Composition  | 1                            |                  |
| Voltage      | $\sim$ or $\equiv$ 24...48 V | $\sim$ 110...240 |
| Reference    | LA2KT2E                      | LA2KT2U          |

4

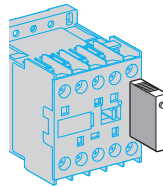

## Suppressor modules

For LC1, LP1-K

| Type      | Varistor ( $\sim$ and $\equiv$ ) |           |            |             | Diode ( $\equiv$ ) + Zener |           | RC ( $\sim$ ) |
|-----------|----------------------------------|-----------|------------|-------------|----------------------------|-----------|---------------|
| Voltage   | 12...24 V                        | 32...48 V | 50...129 V | 130...250 V | 12...24 V                  | 32...48 V | 220...250 V   |
| Reference | LA4KE1B                          | LA4KE1E   | LA4KE1FC   | LA4KE1UG    | LA4KC1B                    | LA4KC1E   | LA4KA1U       |



## Connections

screw clamp terminals or connectors

|   |                          |               |               |               |               |               |               |
|---|--------------------------|---------------|---------------|---------------|---------------|---------------|---------------|
| <b>Rated operational voltage</b>                            |                          | 690 V         |               |               |               |               |               |
| <b>Rated operational current</b>                            | le max AC-3 (Ue ≤ 440 V) | 9 A           | 12 A          | 18 A          | 25 A          | 32 A          | 38 A          |
|   | le AC-1 (θ ≤ 60° C)      | 25 A          |               | 32 A          | 40 A          | 50 A          |               |
| <b>Rated operational power in category AC3</b>              | 220/240 V                | 2.2 kW        | 3 kW          | 4 kW          | 5.5 kW        | 7.5 kW        | 9 kW          |
|   | 380/400 V                | 4 kW          | 5.5 kW        | 7.5 kW        | 11 kW         | 15 kW         | 18.5 kW       |
|   | 415/440 V                | 4 kW          | 5.5 kW        | 9 kW          | 11 kW         | 15 kW         | 18.5 kW       |
|   | 500 V                    | 5.5 kW        | 7.5 kW        | 10 kW         | 15 kW         | 18.5 kW       | 18.5 kW       |
|   | 660/690 V                | 5.5 kW        | 7.5 kW        | 10 kW         | 15 kW         | 18.5 kW       | 18.5 kW       |
| 1000 V  | –                        | –             | –             | –             | –             | –             |               |
| <b>Contactor type *</b>                                     |                          | <b>LC1D09</b> | <b>LC1D12</b> | <b>LC1D18</b> | <b>LC1D25</b> | <b>LC1D32</b> | <b>LC1D38</b> |
| <b>Reversing contactor type * with mechanical interlock</b> |                          | <b>LC2D09</b> | <b>LC2D12</b> | <b>LC2D18</b> | <b>LC2D25</b> | <b>LC2D32</b> | <b>LC2D38</b> |

spring terminals (1)

Add the figure 3 before the voltage code. Example: LC1D09P7 becomes LC1-093P7

lug-clamps (2)

Add the figure 6 before the voltage code. Example: LC1D09P7 becomes LC1-096P7

Faston connectors (3) 2 x 6.35 (power) and 1 x 6.35 (control) up to D12 only

Add the figure 9 before the voltage code. Example: LC1D09P7 becomes LC1-099P7

\* Basic reference to be completed by adding the coil voltage code



(1)



(2)



(3)

## Standard control circuit voltages

~ supply

|       |    |    |    |     |     |     |     |     |     |     |     |     |     |
|-------|----|----|----|-----|-----|-----|-----|-----|-----|-----|-----|-----|-----|
| Volts | 24 | 42 | 48 | 110 | 115 | 220 | 230 | 240 | 380 | 400 | 415 | 440 | 500 |
|-------|----|----|----|-----|-----|-----|-----|-----|-----|-----|-----|-----|-----|

**Contactors LC1D09...D150** (coils D115 and D150 with integral suppression device fitted as standard)

|          |           |           |           |           |            |           |           |           |           |           |           |           |           |
|----------|-----------|-----------|-----------|-----------|------------|-----------|-----------|-----------|-----------|-----------|-----------|-----------|-----------|
| 50/60 Hz | <b>B7</b> | <b>D7</b> | <b>E7</b> | <b>F7</b> | <b>FE7</b> | <b>M7</b> | <b>P7</b> | <b>U7</b> | <b>Q7</b> | <b>V7</b> | <b>N7</b> | <b>R7</b> | <b>S7</b> |
|----------|-----------|-----------|-----------|-----------|------------|-----------|-----------|-----------|-----------|-----------|-----------|-----------|-----------|

**Contactors LC1D80...D115**

|       |           |           |           |           |            |           |           |           |           |           |           |           |           |
|-------|-----------|-----------|-----------|-----------|------------|-----------|-----------|-----------|-----------|-----------|-----------|-----------|-----------|
| 50 Hz | <b>B5</b> | <b>D5</b> | <b>E5</b> | <b>F5</b> | <b>FE5</b> | <b>M5</b> | <b>P5</b> | <b>U5</b> | <b>Q5</b> | <b>V5</b> | <b>N5</b> | <b>R5</b> | <b>S5</b> |
|-------|-----------|-----------|-----------|-----------|------------|-----------|-----------|-----------|-----------|-----------|-----------|-----------|-----------|

|       |           |   |           |           |   |           |   |           |           |   |   |           |   |
|-------|-----------|---|-----------|-----------|---|-----------|---|-----------|-----------|---|---|-----------|---|
| 60 Hz | <b>B6</b> | - | <b>E6</b> | <b>F6</b> | - | <b>M6</b> | - | <b>U6</b> | <b>Q6</b> | - | - | <b>R6</b> | - |
|-------|-----------|---|-----------|-----------|---|-----------|---|-----------|-----------|---|---|-----------|---|

⎓ supply

|       |    |    |    |    |    |    |     |     |     |     |     |
|-------|----|----|----|----|----|----|-----|-----|-----|-----|-----|
| Volts | 12 | 24 | 36 | 48 | 60 | 72 | 110 | 125 | 220 | 250 | 440 |
|-------|----|----|----|----|----|----|-----|-----|-----|-----|-----|

**Contactors LC1D09...D65A** (coils with integral suppression device fitted as standard)

|                  |           |           |           |           |           |           |           |           |           |           |           |
|------------------|-----------|-----------|-----------|-----------|-----------|-----------|-----------|-----------|-----------|-----------|-----------|
| U 0.75...1.25 Uc | <b>JD</b> | <b>BD</b> | <b>CD</b> | <b>ED</b> | <b>ND</b> | <b>SD</b> | <b>FD</b> | <b>GD</b> | <b>MD</b> | <b>UD</b> | <b>RD</b> |
|------------------|-----------|-----------|-----------|-----------|-----------|-----------|-----------|-----------|-----------|-----------|-----------|

**Contactors LC1D80...D95**

|                 |           |           |           |           |           |           |           |           |           |           |           |
|-----------------|-----------|-----------|-----------|-----------|-----------|-----------|-----------|-----------|-----------|-----------|-----------|
| U 0.85...1.1 Uc | <b>JD</b> | <b>BD</b> | <b>CD</b> | <b>ED</b> | <b>ND</b> | <b>SD</b> | <b>FD</b> | <b>GD</b> | <b>MD</b> | <b>UD</b> | <b>RD</b> |
|-----------------|-----------|-----------|-----------|-----------|-----------|-----------|-----------|-----------|-----------|-----------|-----------|

|                 |           |           |           |           |   |           |           |   |           |   |   |
|-----------------|-----------|-----------|-----------|-----------|---|-----------|-----------|---|-----------|---|---|
| U 0.75...1.2 Uc | <b>JW</b> | <b>BW</b> | <b>CW</b> | <b>EW</b> | - | <b>SW</b> | <b>FW</b> | - | <b>MW</b> | - | - |
|-----------------|-----------|-----------|-----------|-----------|---|-----------|-----------|---|-----------|---|---|

**Contactors LC1D115 and D150** (coils with integral suppression device fitted as standard)

|                 |   |           |   |           |           |           |           |           |           |           |           |
|-----------------|---|-----------|---|-----------|-----------|-----------|-----------|-----------|-----------|-----------|-----------|
| U 0.75...1.2 Uc | - | <b>BD</b> | - | <b>ED</b> | <b>ND</b> | <b>SD</b> | <b>FD</b> | <b>GD</b> | <b>MD</b> | <b>UD</b> | <b>RD</b> |
|-----------------|---|-----------|---|-----------|-----------|-----------|-----------|-----------|-----------|-----------|-----------|

Low consumption

**Contactors LC1D09...D38** (coils with integral suppression device fitted as standard)

|         |   |    |    |    |    |     |     |     |
|---------|---|----|----|----|----|-----|-----|-----|
| Volts ⎓ | 5 | 12 | 20 | 24 | 48 | 110 | 120 | 250 |
|---------|---|----|----|----|----|-----|-----|-----|

|                 |           |           |           |           |           |           |           |           |
|-----------------|-----------|-----------|-----------|-----------|-----------|-----------|-----------|-----------|
| U 0.7...1.25 Uc | <b>AL</b> | <b>JL</b> | <b>ZL</b> | <b>BL</b> | <b>EL</b> | <b>FL</b> | <b>ML</b> | <b>UL</b> |
|-----------------|-----------|-----------|-----------|-----------|-----------|-----------|-----------|-----------|

Example of complete reference: **LC1D09P7**



| 690 V          |                |                | 1000 V on ~ supply, 690 V on ≡ supply |               |                |                |
|----------------|----------------|----------------|---------------------------------------|---------------|----------------|----------------|
| 40 A           | 50 A           | 65 A           | 80 A                                  | 95 A          | 115 A          | 150 A          |
| 60 A           | 80 A           | 80 A           | 125 A                                 |               | 200 A          |                |
| 11 kW          | 15 kW          | 18.5 kW        | 22 kW                                 | 25 kW         | 30 kW          | 40 kW          |
| 18.5 kW        | 22 kW          | 30 kW          | 37 kW                                 | 45 kW         | 55 kW          | 75 kW          |
| 22 kW          | 25 kW          | 30 kW          | 45 kW                                 | 45 kW         | 59 kW          | 80 kW          |
| 22 kW          | 30 kW          | 37 kW          | 55 kW                                 | 55 kW         | 75 kW          | 90 kW          |
| 30 kW          | 33 kW          | 37 kW          | 45 kW                                 | 45 kW         | 80 kW          | 100 kW         |
| –              | –              | –              | 45 kW                                 | 45 kW         | 75 kW          | 90 kW          |
| <b>LC1D40A</b> | <b>LC1D50A</b> | <b>LC1D65A</b> | <b>LC1D80</b>                         | <b>LC1D95</b> | <b>LC1D115</b> | <b>LC1D150</b> |
| <b>LC2D40A</b> | <b>LC2D50A</b> | <b>LC2D65A</b> | <b>LC2D80</b>                         | <b>LC2D95</b> | <b>LC2D115</b> | <b>LC2D150</b> |

### Mounting accessories for 3-pole reversing contactors

2 identical contactors with screw clamp terminals or connectors, horizontally mounted

| Mechanical interlock   | Set of connections   | Mechanical interlock   |
|--|--|--|
| <b>■ with an electrical interlocking kit for the contactors</b><br>LC1-D09...D38   | <b>LAD-9R1V</b>  | included   |
| <b>■ with integral electrical interlocking</b><br>LC1-D80 and D95 (~)<br>LC1-D80 and D95 (≡)<br>LC1-D115 and D150          | <b>LA9D8069</b><br><b>LA9D8069</b><br><b>LA9D11569</b>               | <b>LA9D4002</b><br><b>LA9D8002</b><br><b>LA9D11502</b>       |
| <b>■ without electrical interlocking</b><br>LC1-D09...D38<br>LC1-D40A...D65A<br>LC1-D80 and D95 (~)<br>LC1-D80 and D95 (≡) | <b>LA99R1</b><br><b>LAD9R3</b><br><b>LA9D8069</b><br><b>LA9D8069</b> | included<br>included<br><b>LA9D50978</b><br><b>LA9D80978</b> |



### Mechanical latch blocks

Clip-on front mounting, manual or electrical unlatching control

| For use on contactor  | Reference       | Standard control circuit voltages |
|---|-----------------|-----------------------------------|
| <b>LC1D09...D65A ~ or ≡, LC1DT20...DT80 ~ or ≡</b>            | <b>LAD6K10•</b> | <b>B E F M Q</b>                  |
| <b>LC1D80...D150 3P ~, LC1D80 and D115 3P ~, LC1D115 4P ≡</b> | <b>LA6DK20•</b> | <b>B E F M Q</b>                  |



| Contact type   |         |             | instantaneous, connection by screw terminals |               |
|----------------|---------|-------------|--|---------------|
| Block mounting |         |             | Front mounting                               | Side mounting |
| References     | Contact | 1 NO        | LADN10                                       | –             |
|                |         | 1 NC        | LADN01                                       | –             |
|                |         | 1 NO + 1 NC | LADN11                                       | LAD8N11       |
|                |         | 2 NO        | LADN20                                       | LAD8N20       |
|                |         | 2 NC        | LADN02                                       | LAD8N02       |
|                |         | 2 NO + 2 NC | LADN22                                       | –             |
|                |         | 1 NO + 3 NC | LADN13                                       | –             |
|                |         | 3 NO + 1 NC | LADN31                                       | –             |
|                |         | 4 NO        | LADN40                                       | –             |
|                | 4 NC    | LADN04      | –  |               |



| Contact type   |           | Time delay, connection by screw terminals |            |            |
|----------------|-----------|---|------------|------------|
| Block mounting |           | Front mounting                            |            |            |
| References     | On-delay  | 0.1...3 s                                 | 0.1...30 s | 10...180 s |
|                | Off-delay | LADT0                                     | LADT2      | LADT4      |
|                |           | LADR0                                     | LADR2      | LADR4      |

### Maximum number of auxiliary contacts that can be fitted

| Type               | Number of poles and size |                           | Instantaneous |               |     |                |            |            | Time delay     |
|--------------------|--------------------------|---------------------------|---------------|---------------|-----|----------------|------------|------------|----------------|
|                    |                          |                           | Side mounting |               |     | Front mounting |            |            | Front mounting |
|                    |                          |                           | on left side  | on right side |     | 1 contact      | 2 contacts | 4 contacts |                |
| AC                 | 3P                       | LC1D09...D38              | 1             | –             | and | –              | 1          | or 1       | or 1           |
|                    |                          | LC1D40A...D65A            | 1             | or 1          | and | –              | 1          | or 1       | or 1           |
|                    |                          | LC1D80...95 (50/60 Hz)    | 1             | 1             | or  | 2              | and 1      | or 1       | or 1           |
|                    |                          | LC1D80...95 (50 or 60 Hz) | 1             | 1             | and | 2              | and 1      | or 1       | or 1           |
|                    |                          | LC1D115 and D150          | 1             | –             | and | –              | 1          | or 1       | or 1           |
|                    | 4P                       | LC1DT20...DT40            | 1             | –             | and | –              | 1          | or 1       | or 1           |
| LC1DT60A...D80A    |                          | 1                         | or 1          | and           | –   | 1              | or 1       | or 1       |                |
| LC1D115            |                          | 1                         | 1             | and           | 1   | or 1           | or 1       | or 1       |                |
| DC                 | 3P                       | LC1D09...D38              | –             | –             | and | –              | 1          | or 1       | or 1           |
|                    |                          | LC1D40A...D65A            | 1             | or 1          | and | –              | 1          | or 1       | or 1           |
|                    |                          | LC1D80 and 95             | –             | –             | and | 1              | or 1       | or 1       | or 1           |
|                    |                          | LC1D115 and D150          | 1             | –             | and | –              | 1          | or 1       | or 1           |
|                    | 4P                       | LC1DT20...DT40            | –             | –             | and | –              | 1          | or 1       | or 1           |
|                    |                          | LC1DT60A...D80A           | –             | –             | and | –              | 1          | or 1       | or 1           |
|                    |                          | LC1D115                   | 1             | 1             | and | –              | and 1      | or 1       | or 1           |
| DC low consumption | 3P                       | LC1D09...D38              | –             | –             | and | –              | 1          | –          | –              |
|                    | 4P                       | LC1DT20...DT40            | –             | –             | and | –              | 1          | –          | –              |

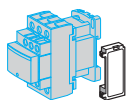

| Type of module                |         |               | RC circuits (Resistor-Capacitor) |                                   |                               |
|-------------------------------|---------|---------------|----------------------------------|-----------------------------------|-------------------------------|
| <b>Mounting</b>               |         |               | Side clip-on                     | Front clip-on                     | Screw fixing                  |
| <b>For use with contactor</b> |         |               | D09...D38(3P) DT20...DT40(4P)    | D40A...D65A(3P) DT60A...DT80A(4P) | D80...D150(3P) D40...D115(4P) |
| <b>References</b>             | Voltage | 24...48 VAC   | LAD4RCE                          | LAD4RC3E                          | LA4DA2E                       |
|                               |         | 50...127 VAC  | LAD4RCG                          | LAD4RC3G                          | LA4DA2G                       |
|                               |         | 110...240 VAC | LAD4RCU                          | LAD4RC3U                          | LA4DA2U                       |
|                               |         | 380...415 VAC | –                                | LAD4RC3N                          | LA4DA2N                       |

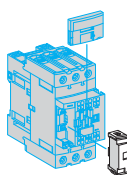

| Type of module                |         |               | Varistors (peak limiting)     |                                   |                               |
|-------------------------------|---------|---------------|-------------------------------|-----------------------------------|-------------------------------|
| <b>Mounting</b>               |         |               | Side clip-on                  | Front clip-on                     | Screw fixing                  |
| <b>For use with contactor</b> |         |               | D09...D38(3P) DT20...DT40(4P) | D40A...D65A(3P) DT60A...DT80A(4P) | D80...D150(3P) D40...D115(4P) |
| <b>References</b>             | Voltage | 24...48 VAC   | LAD4VE                        | LAD4V3E                           | LA4DE2E                       |
|                               |         | 50...127 VAC  | LAD4VG                        | LAD4V3G                           | LA4DE2G                       |
|                               |         | 110...240 VAC | LAD4VU                        | LAD4V3U                           | LA4DE2U                       |
|                               |         | 24...48 VDC   | –                             | –                                 | LAD4DE3E (AC and DC)          |
|                               |         | 50...127 VDC  | –                             | –                                 | LAD4DE3G (AC and DC)          |
|                               |         | 110...240 VDC | –                             | –                                 | LAD4DE3U (AC and DC)          |

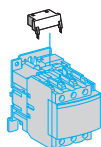

| Type of module                |         |              | Flywheel diodes               |                                   |                               |
|-------------------------------|---------|--------------|-------------------------------|-----------------------------------|-------------------------------|
| <b>Mounting</b>               |         |              | Side clip-on                  | Front clip-on                     | Screw fixing                  |
| <b>For use with contactor</b> |         |              | D09...D38(3P) DT20...DT40(4P) | D40A...D65A(3P) DT60A...DT80A(4P) | D80...D150(3P) D40...D115(4P) |
| <b>References</b>             | Voltage | 24...250 VDC | LAD4DDL                       | LAD4D3U                           | LAD4DC3U                      |

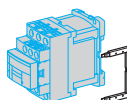

| Type of module                |         |         | Bidirectional peak limiting diode |                                   |                               |
|-------------------------------|---------|---------|-----------------------------------|-----------------------------------|-------------------------------|
| <b>Mounting</b>               |         |         | Side clip-on                      | Front clip-on                     | Screw fixing                  |
| <b>For use with contactor</b> |         |         | D09...D38(3P) DT20...DT40(4P)     | D40A...D65A(3P) DT60A...DT80A(4P) | D80...D150(3P) D40...D115(4P) |
| <b>References</b>             | Voltage | 24 VAC  | LAD4TB                            | LAD4T3B                           | LA4DB2B                       |
|                               |         | 24 VDC  | LAD4TBDL                          | LAD4T3B                           | LA4DB2S                       |
|                               |         | 72 VAC  | LAD4TS                            | LAD4T3S                           | LA4DB3B                       |
|                               |         | 72 VDC  | LAD4TSDL                          | LAD4T3S                           | LA4DB3S                       |
|                               |         | 125 VDC | LAD4TGDL                          | LAD4T3G (AC and DC)               | –                             |
|                               |         | 250 VDC | LAD4TUDL                          | LAD4T3U (AC and DC)               | –                             |
|                               |         | 600 VDC | LAD4TXDL                          | LAD4T3R (AC and DC)               | –                             |



|                                  |                          |                |                |                |                |
|----------------------------------|--------------------------|----------------|----------------|----------------|----------------|
| <b>Rated operational current</b> | le max AC-3 (Ue ≤ 440 V) | 185 A          | 225 A          | 265 A          | 330 A          |
|                                  | le AC-1 (θ ≤ 40° C)      | 275 A          | 315 V          | 350 A          | 400 A          |
| <b>Rated operational voltage</b> |                          | 1 000 V        | 1 000 V        | 1 000 V        | 1 000 V        |
| <b>Number of poles</b>           |                          | 3 or 4         | 3 or 4         | 3 or 4         | 3 or 4         |
| <b>Rated operational power</b>   | 220/240 V                | 55 kW          | 63 kW          | 75 kW          | 100 kW         |
| <b>in category AC3</b>           | 380/400 V                | 90 kW          | 110 kW         | 132 kW         | 160 kW         |
|                                  | 415 V                    | 100 kW         | 110 kW         | 140 kW         | 180 kW         |
|                                  | 440 V                    | 100 kW         | 110 kW         | 140 kW         | 200 kW         |
|                                  | 500 V                    | 110 kW         | 129 kW         | 160 kW         | 200 kW         |
|                                  | 660/690 V                | 110 kW         | 129 kW         | 160 kW         | 220 kW         |
|                                  | 1000 V                   | 100 kW         | 100 kW         | 147 kW         | 160 kW         |
| <b>Contactor type*</b>           |                          | <b>LC1F185</b> | <b>LC1F225</b> | <b>LC1F265</b> | <b>LC1F330</b> |
| <b>Reversing contactor type*</b> |                          | <b>LC2F185</b> | <b>LC2F225</b> | <b>LC2F265</b> |                |

\* Basic reference to be completed by adding the coil voltage code

## Standard control circuit voltages

| ~ supply   |    |    |     |     |        |     |     |     |     |     |     |     |      |
|--|----|----|-----|-----|--------|-----|-----|-----|-----|-----|-----|-----|------|
| Volts  | 24 | 48 | 110 | 115 | 120    | 208 | 220 | 230 | 240 | 380 | 400 | 415 | 440  |
| <b>Contactors LC1F115...F225 (0.85...1.1 Uc)</b> |    |    |     |     |        |     |     |     |     |     |     |     |      |
| 50 Hz (coil LX1)                                 | B5 | E5 | F5  | FE5 | -      | -   | M5  | P5  | U5  | Q5  | V5  | N5  | -    |
| 60 Hz (coil LX1)                                 | -  | E6 | F6  | -   | G6     | L6  | M6  | -   | U6  | Q6  | -   | -   | R6U7 |
| 40...400 Hz (coil LX9)                           | -  | E7 | F7  | FE7 | G7     | L7  | M7  | P7  | U7  | Q7  | V7  | N7  | R7   |
| <b>Contactors LC1F265...F330U7</b>               |    |    |     |     |        |     |     |     |     |     |     |     |      |
| 40...400 Hz (coil LX1)                           | B7 | E7 | F7  | FE7 | G7     | L7  | M7  | P7  | U7  | Q7  | V7  | N7  | R7   |
| <b>Contactors LC1F400...F630U7</b>               |    |    |     |     |        |     |     |     |     |     |     |     |      |
| 40...400 Hz (coil LX1)                           | -  | E7 | F7  | FE7 | G7 (1) | L7  | M7  | P7  | U7  | Q7  | V7  | N7  | R7   |
| <b>Contactors LC1F780U7</b>                      |    |    |     |     |        |     |     |     |     |     |     |     |      |
| 40...400 Hz (coil LX1)                           | -  | -  | F7  | FE7 | F7     | L7  | M7  | P7  | U7  | Q7  | V7  | N7  | R7   |
| <b>Contactors LC1F800U7</b>                      |    |    |     |     |        |     |     |     |     |     |     |     |      |
| 40...400 Hz (coil LX1)                           | -  | -  | FE7 | FE7 | FE7    | -   | P7  | P7  | P7  | V7  | V7  | V7  | V7Y7 |
| --- supply                                       |    |    |     |     |        |     |     |     |     |     |     |     |      |
| Volts  | 24 | 48 | 110 | 125 | 220    | 230 | 250 | 400 | 440 |     |     |     |      |
| <b>Contactors LC1F115...F330 (0.85...1.1 Uc)</b> |    |    |     |     |        |     |     |     |     |     |     |     |      |
| (coil LX4-F)                                     | BD | ED | FD  | GD  | MD     | MD  | UD  | -   | RD  |     |     |     |      |
| <b>Contactors LC1F400...F630 (0.85...1.1 Uc)</b> |    |    |     |     |        |     |     |     |     |     |     |     |      |
| (coil LX4-F)                                     | -  | ED | FD  | GD  | MD     | -   | UD  | -   | RD  |     |     |     |      |
| <b>Contactors LC1F780 (0.85...1.1 Uc)</b>        |    |    |     |     |        |     |     |     |     |     |     |     |      |
| (coil LX4-F)                                     | -  | -  | FD  | GD  | MD     | -   | UD  | -   | RD  |     |     |     |      |
| <b>Contactors LC1F800 (0.85...1.1 Uc)</b>        |    |    |     |     |        |     |     |     |     |     |     |     |      |
| (coil LX4-F)                                     | -  | -  | FW  | FW  | MW     | MW  | -   | QW  | -   |     |     |     |      |
| <b>Contactors LC1F1250</b>                       |    |    |     |     |        |     |     |     |     |     |     |     |      |
| (coil LX4F)                                      | -  | ED | FD  | -   | MD     | -   | UD  | -   | -   | -   | -   | -   | -    |
| <b>Contactors LC1F1400</b>                       |    |    |     |     |        |     |     |     |     |     |     |     |      |
| (coil LX4F)                                      | -  | -  | FD  | GD  | MD     | -   | UD  | -   | RD  | -   | -   | -   | -    |

Example: For a 630 A contactor with a 110 V ~ coil, order **LC1F630F7**

(1) F7 for LC1-F630





|  |                       |                |                |                |                |                 |                 |
|--|-----------------------|----------------|----------------|----------------|----------------|-----------------|-----------------|
|  | 400 A                 | 500 A          | 630 A          | 780 A          | 800 A          | -               | -               |
|  | 500 A                 | 700 A          | 1 000 A        | 1 600 A        | 1 000 A        | 1260            | 1400            |
|  | 1 000 V               | 1 000 V        | 1 000 V        | 1 000 V        | 1 000 V        | 1000            | 1000            |
|  | 2, 3 or 4             | 2, 3 or 4      | 2, 3 or 4      | 3 or 4         | 3              | 3               | 3               |
|  | 110 kW                | 147 kW         | 200 kW         | 220 kW         | 250 kW         | Sans objets     | Sans objets     |
|  | 200 kW                | 250 kW         | 335 kW         | 400 kW         | 450 kW         | en AC1          | en AC1          |
|  | 220 kW                | 280 kW         | 375 kW         | 425 kW         | 450 kW         | -               | -               |
|  | 250 kW                | 295 kW         | 400 kW         | 425 kW         | 450 kW         | -               | -               |
|  | 257 kW                | 355 kW         | 400 kW         | 450 kW         | 450 kW         | -               | -               |
|  | 280 kW                | 335 kW         | 450 kW         | 475 kW         | 475 kW         | -               | -               |
|  | 185 kW                | 335 kW         | 450 kW         | 450 kW         | 450 kW         | -               | -               |
|  | <b>LC1F400</b>        | <b>LC1F500</b> | <b>LC1F630</b> | <b>LC1F780</b> | <b>LC1F800</b> | <b>LC1F1250</b> | <b>LC1F1400</b> |
|  | For customer assembly |                |                |                |                | -               | -               |

4



### Auxiliary contact blocks

| instantaneous |           |             |           | dust & damp protected contacts |           |             |           | time delay 1 NO + 1 NC |            |           |
|---------------|-----------|-------------|-----------|--------------------------------|-----------|-------------|-----------|------------------------|------------|-----------|
| Composition   | Reference | Composition | Reference | Composition                    | Reference | Composition | Reference | Type                   | Range      | Reference |
| NO NC         |           | NO NC       |           | NO NC                          |           | NO NC       |           |                        |            |           |
| 1 -           | LADN10    | 1 1         | LADN11    | 2 2                            | LADN22    | 2 - - -     | LA1DX20   | On-delay               | 0.1...3 s  | LADT0     |
| - 1           | LADN01    | 2 -         | LADN20    | 1 3                            | LADN13    | 2 2 - -     | LA1DY20   |                        | 0.1...30 s | LADT2     |
|               |           | - 2         | LADN02    | 4 -                            | LADN40    | 2 - 2 -     | LA1DZ40   |                        | 10...180 s | LADT4     |
|               |           |             |           | - 4                            | LADN04    | 2 - 1 1     | LA1DZ31   |                        | 1...30 s   | LADS2     |
|               |           |             |           | 3 1                            | LADN31    |             |           | Off-delay              | 0.1...3 s  | LADR0     |
|               |           |             |           | 2 2                            | LADC22    |             |           |                        | 0.1...30 s | LADR2     |
|               |           |             |           |                                |           |             |           |                        | 10...180 s | LADR4     |

### Mounting accessories for 3-pole reversing contactors for motor control

2 identical contactors, horizontally mounted

#### Mechanical interlock with an electrical interlocking kit for the contactors

| Contactor type     | Set of connections | Mechanical interlock |
|--------------------|--------------------|----------------------|
| LC1F115            | LA9FF976           | LA9FF970             |
| LC1F150            | LA9F15076          | LA9FF970             |
| LC1F185            | LA9FG976           | LA9FG970             |
| LC1F225            | LA9F22576          | LA9FG970             |
| LC1F265            | LA9FH976           | LA9FJ970             |
| LC1F330            | LA9FJ976           | LA9FJ970             |
| LC1F400            | LA9FJ976           | LA9FJ970             |
| LC1F500            | LA9FK976           | LA9FJ970             |
| LC1F630 or LC1F800 | LA9FL976           | LA9FL970             |
| LCIF1250           | -                  | -                    |
| LCIF1400           | -                  | -                    |

# TeSys B Contactors

## 400...900 kW

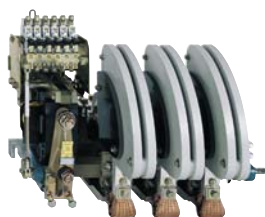

| <b>Rated operational current</b>              | le max AC-3 (Ue ≤ 440 V) | 750 A        | 1000 A       | 1500 A       | 1800 A       |
|---|--------------------------|--------------|--------------|--------------|--------------|
|   | le AC-1 (θ ≤ 40° C)      | 800 A        | 1250 V       | 2000 A       | 2750 A       |
| <b>Rated operational voltage</b>              |                          | 1 000 V      | 1 000 V      | 1 000 V      | 1 000 V      |
| <b>Number of poles</b>                        |                          | 1 to 4       | 1 to 4       | 1 to 4       | 1 to 4       |
| <b>Rated operational power</b>                | 220/240 V                | 220 kW       | 280 kW       | 425 kW       | 500 kW       |
| <b>in category AC3</b>                        | 380/400 V                | 400 kW       | 500 kW       | 750 kW       | 900 kW       |
|   | 415 V                    | 425 kW       | 530 kW       | 800 kW       | 900 kW       |
|   | 440 V                    | 450 kW       | 560 kW       | 800 kW       | 900 kW       |
|   | 500 V                    | 500 kW       | 600 kW       | 700 kW       | 900 kW       |
|   | 660/690 V                | 560 kW       | 670 kW       | 750 kW       | 900 kW       |
|   | 1000 V                   | 530 kW       | 530 kW       | 670 kW       | 750 kW       |
| 4 instantaneous contact configurations        |                          |              |              |              |              |
| 2 NC + 2 NO, 3 NO + 1 NC, 1 NO + 3 NC or 4 NO |                          |              |              |              |              |
| <b>Contactor type*</b>                        |                          | <b>LC1BL</b> | <b>LC1BM</b> | <b>LC1BP</b> | <b>LC1BR</b> |

\* Basic reference to be completed by adding the coil voltage code, followed by the instantaneous contact configuration.

| <b>Standard control circuit voltages</b> (for other voltages, please consult your Regional Sales Office) |           |           |           |          |           |          |          |          |          |          |           |          |
|--|-----------|-----------|-----------|----------|-----------|----------|----------|----------|----------|----------|-----------|----------|
| Volts  | 48        | 110       | 125       | 127      | 220       | 230      | 240      | 380      | 400      | 415      | 440       | 500      |
| ~ 50...400 Hz  | -         | <b>F</b>  | -         | <b>G</b> | <b>M</b>  | <b>P</b> | <b>U</b> | <b>Q</b> | <b>V</b> | <b>N</b> | <b>R</b>  | <b>S</b> |
| ---  | <b>ED</b> | <b>FD</b> | <b>GD</b> | -        | <b>MD</b> | -        | -        | -        | -        | -        | <b>RD</b> | -        |

Example: To order a 1500 A contactor with 127 V --- coil with 3 NO + 1 NC, select **LC1BP33G31**

| <b>Mounting accessories</b>                               |                    |                  |
|---|--------------------|------------------|
| Description   | For contactor      | Reference        |
| <b>Bar support bracket</b>                                | <b>LC1BL to BR</b> | <b>LA9B103</b>   |
| for mounting on 120 or 150 mm centres                     |                    |                  |
| <b>Mechanical interlock and locking device components</b> | <b>LC1B</b>        | <b>EZ2LB0601</b> |

| Reference to compiled by the customer                                      |                      |             |          |          |          |          |          |          |          |
|--|----------------------|-------------|----------|----------|----------|----------|----------|----------|----------|
| <b>Contact type, according to required use</b>                             |                      |             |          |          |          |          |          |          |          |
| ~ supply 690 V, ≡ supply 220 V/pole  |                      | <b>CV1B</b> |          |          |          |          |          |          |          |
| ~ supply 1000 V, ≡ supply 440 V/pole                                       |                      | <b>CV3B</b> |          |          |          |          |          |          |          |
| <b>Contact rating</b>  | CV1: 80 A            | CV3: 80 A   |          | <b>F</b> |          |          |          |          |          |
|  | CV1: 200 A           | CV3: 170 A  |          | <b>G</b> |          |          |          |          |          |
|  | CV1: 300 A           | CV3: 250 A  |          | <b>H</b> |          |          |          |          |          |
|  | CV1: 470 A           | CV3: 320 A  |          | <b>J</b> |          |          |          |          |          |
|  | CV1: 630 A           | CV3: 500 A  |          | <b>K</b> |          |          |          |          |          |
|  | CV1: 1000 A          |             |          | <b>L</b> |          |          |          |          |          |
| <b>Number of poles (PN1 main poles for CV1 and PA3 main poles for CV3)</b> |                      |             |          |          |          |          |          |          |          |
| Normally Open main poles   | 1 NO                 |             |          | <b>1</b> |          |          |          |          |          |
|  | 2 NO                 |             |          | <b>2</b> |          |          |          |          |          |
|  | 3 NO                 |             |          | <b>3</b> |          |          |          |          |          |
|  | 4 NO                 |             |          | <b>4</b> |          |          |          |          |          |
|  | 5 NO                 |             |          | <b>5</b> |          |          |          |          |          |
| Normally Closed main poles   | 1 NC                 |             |          |          | <b>1</b> |          |          |          |          |
|  | 2 NC                 |             |          |          | <b>2</b> |          |          |          |          |
|  | 3 NC                 |             |          |          | <b>3</b> |          |          |          |          |
| No main poles  |                      |             | <b>0</b> | <b>Z</b> | <b>0</b> | <b>Z</b> |          |          |          |
| <b>Operational current</b>   | 10 A                 |             |          |          | <b>E</b> |          | <b>E</b> |          |          |
|  | 20 A                 |             |          |          | <b>N</b> |          | <b>N</b> |          |          |
|  | 40 A                 |             |          |          | <b>P</b> |          | <b>P</b> |          |          |
|  | 80 A                 |             |          |          | <b>F</b> |          | <b>F</b> |          |          |
|  | 125 A                |             |          |          | <b>R</b> |          | <b>R</b> |          |          |
|  | 170 A                |             |          |          | <b>W</b> |          | <b>W</b> |          |          |
|  | 200 A                |             |          |          | <b>G</b> |          | <b>G</b> |          |          |
|  | 250 A                |             |          |          | <b>S</b> |          | <b>S</b> |          |          |
|  | 300 A                |             |          |          | <b>H</b> |          | <b>H</b> |          |          |
|  | 320 A                |             |          |          | <b>T</b> |          | <b>T</b> |          |          |
|  | 470 A                |             |          |          | <b>J</b> |          | <b>J</b> |          |          |
|  | 500 A                |             |          |          | <b>V</b> |          | <b>V</b> |          |          |
|  | 630 A                |             |          |          | <b>K</b> |          | <b>K</b> |          |          |
|  | 1000 A               |             |          |          | <b>L</b> |          | <b>L</b> |          |          |
| <b>Control circuit voltage</b>   | 48 V                 |             |          |          |          |          |          | <b>E</b> |          |
|  | 110 V                |             |          |          |          |          |          | <b>F</b> |          |
|  | 120 V                |             |          |          |          |          |          | <b>K</b> |          |
|  | 208 V                |             |          |          |          |          |          | <b>L</b> |          |
|  | 220 V                |             |          |          |          |          |          | <b>M</b> |          |
|  | 230 V                |             |          |          |          |          |          | <b>P</b> |          |
|  | 240 V                |             |          |          |          |          |          | <b>U</b> |          |
|  | 380 V                |             |          |          |          |          |          | <b>Q</b> |          |
|  | 400 V                |             |          |          |          |          |          | <b>V</b> |          |
|  | 440 V                |             |          |          |          |          |          | <b>R</b> |          |
| <b>Operating frequency</b>   | 50 Hz                |             |          |          |          |          |          | <b>5</b> |          |
|  | 60 Hz                |             |          |          |          |          |          | <b>6</b> |          |
|  | 50/60 Hz             |             |          |          |          |          |          | <b>7</b> |          |
|  | ≡                    |             |          |          |          |          |          | <b>D</b> |          |
|  | ≡ + economy resistor |             |          |          |          |          |          | <b>R</b> |          |
| <b>Instantaneous auxiliary contacts</b>                                    |                      |             |          |          |          |          |          |          |          |
| <b>Normally Open</b>   | 1 NO                 |             |          |          |          |          |          |          | <b>1</b> |
|  | 2 NO                 |             |          |          |          |          |          |          | <b>2</b> |
|  | 3 NO                 |             |          |          |          |          |          |          | <b>3</b> |
|  | 4 NO                 |             |          |          |          |          |          |          | <b>4</b> |
| <b>Normally Closed</b>   | 1 NC                 |             |          |          |          |          |          |          | <b>1</b> |
|  | 2 NC                 |             |          |          |          |          |          |          | <b>2</b> |
|  | 3 NC                 |             |          |          |          |          |          |          | <b>3</b> |
|  | 4 NC                 |             |          |          |          |          |          |          | <b>4</b> |
| Without instantaneous contact  |                      |             |          |          |          |          | <b>0</b> | <b>0</b> |          |
| On-delay   | 1 CO                 |             |          |          |          |          |          |          | <b>J</b> |
| Off-delay  | 1 CO                 |             |          |          |          |          |          |          | <b>N</b> |

Example 1/ for single-phase capacitor switching: 400 V - 80 A - 1 NO pole - Control circuit 220 V / 50 Hz, 1 NO and 1 NC auxiliary contacts: **CV1BF1F0ZM511**.  
 2/ for heating circuits, d.c. supply 800 V - 150 A - 2 NO poles - Control circuit 48 V ≡, 1 NO + 1 NO On-delay auxiliary contacts: **CV3BG2W0ZED10J**



**Thermal-magnetic circuit-breakers GV2-ME and GV2-P for connection by screw clamp terminals**

GV2-ME with pushbutton control, GV2-P control by rotary knob

Standard power ratings of 3-phase motors 50/60 Hz in category AC-3

| 400/415 V |                 |                     |      |                 |                     |      |                 |                     | 500 V       |      | 690 V |   |             | Setting range of thermal trips | Magnetic tripping current | Reference |
|-----------|-----------------|---------------------|------|-----------------|---------------------|------|-----------------|---------------------|-------------|------|-------|---|-------------|--------------------------------|---------------------------|-----------|
| P         | I <sub>cu</sub> | I <sub>cs</sub> (1) | P    | I <sub>cu</sub> | I <sub>cs</sub> (1) | P    | I <sub>cu</sub> | I <sub>cs</sub> (1) |             |      |       |   |             |                                |                           |           |
| kW        | kA              |                     | kW   | kA              |                     | kW   | kA              |                     | A           | A    | A     | A | A (d ± 20%) |                                |                           |           |
| -         | -               | -                   | -    | -               | -                   | -    | -               | -                   | 0.1...0.16  | 1.5  |       |   |             | GV2ME01                        | GV2P01                    |           |
| 0.06      | ★               | ★                   | -    | -               | -                   | -    | -               | -                   | 0.16...0.25 | 2.4  |       |   |             | GV2ME02                        | GV2P02                    |           |
| 0.09      | ★               | ★                   | -    | -               | -                   | -    | -               | -                   | 0.25...0.40 | 5    |       |   |             | GV2ME03                        | GV2P03                    |           |
| 0.12      | ★               | ★                   | -    | -               | -                   | 0.37 | ★               | ★                   | 0.40...0.63 | 8    |       |   |             | GV2ME04                        | GV2P04                    |           |
| 0.18      | ★               | ★                   | -    | -               | -                   | -    | -               | -                   | 0.40...0.63 | 8    |       |   |             | GV2ME04                        | GV2P04                    |           |
| 0.25      | ★               | ★                   | -    | -               | -                   | 0.55 | ★               | ★                   | 0.63...1    | 13   |       |   |             | GV2ME05                        | GV2P05                    |           |
| 0.37      | ★               | ★                   | 0.37 | ★               | ★                   | -    | -               | -                   | 1...1.6     | 22.5 |       |   |             | GV2ME06                        | GV2P06                    |           |
| 0.55      | ★               | ★                   | 0.55 | ★               | ★                   | 0.75 | ★               | ★                   | 1...1.6     | 22.5 |       |   |             | GV2ME06                        | GV2P06                    |           |
| -         | -               | -                   | 0.75 | ★               | ★                   | 1.1  | ★               | ★                   | 1...1.6     | 22.5 |       |   |             | GV2ME06                        | GV2P06                    |           |
| 0.75      | ★               | ★                   | 1.1  | ★               | ★                   | 1.5  | 3               | 75                  | 1.6...2.5   | 33.5 |       |   |             | GV2ME07                        |                           |           |
| 0.75      | ★               | ★                   | 1.1  | ★               | ★                   | 1.5  | 8               | 100                 | 1.6...2.5   | 33.5 |       |   |             |                                | GV2P07                    |           |
| 1.1       | ★               | ★                   | 1.5  | ★               | ★                   | 2.2  | 3               | 75                  | 2.5...4     | 51   |       |   |             | GV2ME08                        |                           |           |
| 1.1       | ★               | ★                   | 1.5  | ★               | ★                   | 2.2  | 8               | 100                 | 2.5...4     | 51   |       |   |             |                                | GV2P08                    |           |
| 1.5       | ★               | ★                   | 2.2  | ★               | ★                   | 3    | 3               | 75                  | 2.5...4     | 51   |       |   |             | GV2ME08                        |                           |           |
| 1.5       | ★               | ★                   | 2.2  | ★               | ★                   | 3    | 3               | 100                 | 2.5...4     | 51   |       |   |             |                                | GV2P08                    |           |
| 2.2       | ★               | ★                   | 3    | 50              | 100                 | 4    | 3               | 75                  | 4...6.3     | 78   |       |   |             | GV2ME10                        |                           |           |
| 2.2       | ★               | ★                   | 3    | ★               | ★                   | 4    | 6               | 100                 | 4...6.3     | 78   |       |   |             |                                | GV2P10                    |           |
| 3         | ★               | ★                   | 4    | 10              | 100                 | 5.5  | 3               | 75                  | 6...10      | 138  |       |   |             | GV2ME14                        |                           |           |
| 3         | ★               | ★                   | 4    | 50              | 100                 | 5.5  | 6               | 100                 | 6...10      | 138  |       |   |             |                                | GV2P14                    |           |
| 4         | ★               | ★                   | 5.5  | 10              | 100                 | 7.5  | 3               | 75                  | 6...10      | 138  |       |   |             | GV2ME14                        |                           |           |
| 4         | ★               | ★                   | 5.5  | 50              | 100                 | 7.5  | 6               | 100                 | 6...10      | 138  |       |   |             |                                | GV2P14                    |           |
| 5.5       | 15              | 50                  | 7.5  | 6               | 75                  | 9    | 3               | 75                  | 9...14      | 170  |       |   |             | GV2ME16                        |                           |           |
| 5.5       | ★               | ★                   | 7.5  | 42              | 75                  | 9    | 6               | 100                 | 9...14      | 170  |       |   |             |                                | GV2P16                    |           |
| -         | -               | -                   | -    | -               | -                   | 11   | 3               | 75                  | 9...14      | 170  |       |   |             | GV2ME16                        |                           |           |
| -         | -               | -                   | -    | -               | -                   | 11   | 6               | 100                 | 9...14      | 170  |       |   |             |                                | GV2P16                    |           |
| 7.5       | 15              | 50                  | 9    | 6               | 75                  | 15   | 3               | 75                  | 13...18     | 223  |       |   |             | GV2ME20                        |                           |           |
| 7.5       | 50              | 50                  | 9    | 10              | 75                  | 15   | 4               | 100                 | 13...18     | 223  |       |   |             |                                | GV2P20                    |           |
| 9         | 15              | 40                  | 11   | 4               | 75                  | 18.5 | 3               | 75                  | 17...23     | 327  |       |   |             | GV2ME21                        |                           |           |
| 9         | 50              | 50                  | 11   | 10              | 75                  | 18.5 | 4               | 100                 | 17...23     | 327  |       |   |             |                                | GV2P21                    |           |
| 11        | 15              | 40                  | 15   | 4               | 75                  | -    | -               | -                   | 20...25     | 327  |       |   |             | GV2ME22 (2)                    |                           |           |
| 11        | 50              | 50                  | 15   | 10              | 75                  | -    | -               | -                   | 20...25     | 327  |       |   |             |                                | GV2P22                    |           |
| 15        | 10              | 50                  | 18.5 | 4               | 75                  | 22   | 3               | 75                  | 24...32     | 416  |       |   |             | GV2ME32                        |                           |           |
| 15        | 50              | 50                  | 18.5 | 10              | 75                  | 22   | 4               | 100                 | 24...32     | 416  |       |   |             |                                | GV2P32                    |           |

H > 100 kA

(1) as % of I<sub>cu</sub>

(2) combined with a recommended contactor

**Thermal-magnetic circuit-breakers GV2-ME for connection by spring terminals**

Add the figure 3 to the end of the reference. Example: GV2ME22 becomes GV2ME223

**Thermal-magnetic circuit-breakers GV2-ME for connection by ring terminals**

Add the figure 6 to the end of the reference. Example: GV2ME32 becomes GV2ME326

**TeSys extended rotary handles**

| These handles are suitable for the following products | GV2 -P et GV2 - L | GV3-P et GV3 - L | TeSys U  |
|---|-------------------|------------------|----------|
| Kit IP54 black handle                                 | GV2APN01          | GV3APN01         | LU9APN21 |
| IP54 kit red handle and yellow front                  | GV2APN02          | GV3APN02         | LU9APN22 |
| IP65 kit red handle and yellow front                  | GV2APN04          | GV3APN04         | LU9APN24 |

Common accessories GV2 / GV3, see page 5/15



**Magnetic circuit-breakers GV2-LE and GV2-L for connection by screw clamp terminals**

GV2-LE control by rocker lever, GV2-L control by rotary knob

| Standard power ratings of 3-phase motors 50/60 Hz in category AC-3 |                 |                     |       |                 |                     |       |                 |                     | Magnetic protection | Tripping current | Use in association with thermal overload relay | Reference         |
|--|-----------------|---------------------|-------|-----------------|---------------------|-------|-----------------|---------------------|---------------------|------------------|--|-------------------|
| 400/415 V  |                 |                     | 500 V |                 |                     | 690 V |                 |                     | rating              | d ± 20%          |  |                   |
| P  | I <sub>cu</sub> | I <sub>cs</sub> (1) | P     | I <sub>cu</sub> | I <sub>cs</sub> (1) | P     | I <sub>cu</sub> | I <sub>cs</sub> (1) | A                   | A                |  |                   |
| kW   | kA              |                     | kW    | kA              |                     | kW    | kA              |                     |                     |                  |  |                   |
| 0.06   | ★               | ★                   | -     | -               | -                   | -     | -               | -                   | 0.4                 | 5                | LR2K0302                                       | GV2LE03           |
| 0.09   | ★               | ★                   | -     | -               | -                   | -     | -               | -                   | 0.4                 | 5                | LR2K0304 or LRD03                              | GV2LE03<br>GV2L03 |
| 0.12   | ★               | ★                   | -     | -               | -                   | 0.37  | ★               | ★                   | 0.63                | 8                | LR2K0304 or LRD04                              | GV2LE04<br>GV2L04 |
| 0.18   | ★               | ★                   | -     | -               | -                   | -     | -               | -                   | 0.63                | 8                | LR2K0305 or LRD04                              | GV2LE04<br>GV2L04 |
| -  | -               | -                   | -     | -               | -                   | 0.55  | ★               | ★                   | 1                   | 13               | LR2K0305 or LRD05                              | GV2LE05<br>GV2L05 |
| 0.25   | ★               | ★                   | -     | -               | -                   | -     | -               | -                   | 1                   | 13               | LR2K0306 or LRD05                              | GV2LE05<br>GV2L05 |
| -  | -               | -                   | -     | -               | -                   | 0.75  | ★               | ★                   | 1                   | 13               | LR2K0306 or LRD06                              | GV2LE05<br>GV2L05 |
| 0.37   | ★               | ★                   | 0.37  | ★               | ★                   | -     | -               | -                   | 1                   | 13               | LR2K0306 or LRD05                              | GV2LE05<br>GV2L05 |
| 0.55   | ★               | ★                   | 0.55  | ★               | ★                   | 1.1   | ★               | ★                   | 1.6                 | 22.5             | LR2K0307 or LRD06                              | GV2LE06<br>GV2L06 |
| -  | -               | -                   | 0.75  | ★               | ★                   | -     | -               | -                   | 1.6                 | 22.5             | LR2K0307 or LRD06                              | GV2LE06<br>GV2L06 |
| 0.75   | ★               | ★                   | 1.1   | ★               | ★                   | 1.5   | 3               | 75                  | 2.5                 | 33.5             | LR2K0308                                       | GV2LE07           |
| 0.75   | ★               | ★                   | 1.1   | ★               | ★                   | 1.5   | 4               | 100                 | 2.5                 | 33.5             | LRD07  | GV2L07            |
| 1.1  | ★               | ★                   | -     | -               | -                   | -     | -               | -                   | 2.5                 | 33.5             | LR2K0308 or LRD08                              | GV2LE08<br>GV2L08 |
| 1.5  | ★               | ★                   | 1.5   | ★               | ★                   | 3     | 3               | 75                  | 4                   | 51               | LR2K0310                                       | GV2LE08           |
| 1.5  | ★               | ★                   | 1.5   | ★               | ★                   | 3     | 4               | 100                 | 4                   | 51               | LRD08  | GV2L08            |
| -  | -               | -                   | 2.2   | ★               | ★                   | -     | -               | -                   | 4                   | 51               | LR2K0312 or LRD08                              | GV2LE08<br>GV2L08 |
| 2.2  | ★               | ★                   | 3     | 50              | 100                 | 4     | 3               | 75                  | 6.3                 | 78               | LR2K0312                                       | GV2LE10           |
| 2.2  | ★               | ★                   | 3     | ★               | ★                   | 4     | 4               | 100                 | 6.3                 | 78               | LRD10  | GV2L10            |
| 3  | ★               | ★                   | 4     | 10              | 100                 | 5.5   | 3               | 75                  | 10                  | 138              | LR2K0314                                       | GV2LE14           |
| 3  | ★               | ★                   | 4     | 10              | 100                 | 5.5   | 4               | 100                 | 10                  | 138              | LRD12  | GV2L14            |
| 4  | ★               | ★                   | 5.5   | 10              | 100                 | -     | -               | -                   | 10                  | 138              | LR2K0316 or LRD14                              | GV2LE14<br>GV2L14 |
| -  | -               | -                   | -     | -               | -                   | 7.5   | 3               | 75                  | 10                  | 138              | LRD14  | GV2LE14           |
| -  | -               | -                   | -     | -               | -                   | 7.5   | 4               | 100                 | 10                  | 138              | LRD14  | GV2L14            |
| -  | -               | -                   | -     | -               | -                   | 9     | 3               | 75                  | 14                  | 170              | LRD16  | GV2LE16           |
| -  | -               | -                   | -     | -               | -                   | 9     | 4               | 100                 | 14                  | 170              | LRD16  | GV2L16            |
| 5.5  | 15              | 50                  | 7.5   | 6               | 75                  | 11    | 3               | 75                  | 14                  | 170              | LR2K0321                                       | GV2LE16           |
| 5.5  | 50              | 50                  | 7.5   | 10              | 75                  | 11    | 4               | 100                 | 14                  | 170              | LRD16  | GV2L16            |
| 7.5  | 15              | 50                  | 9     | 6               | 75                  | 15    | 3               | 75                  | 18                  | 223              | LRD21  | GV2LE20           |
| 7.5  | 50              | 50                  | 9     | 10              | 75                  | 15    | 4               | 100                 | 18                  | 223              | LRD21  | GV2L20            |
| 9  | 15              | 40                  | 11    | 4               | 75                  | 18.5  | 3               | 75                  | 25                  | 327              | LRD22  | GV2LE22           |
| 9  | 50              | 50                  | 11    | 10              | 75                  | 18.5  | 4               | 100                 | 25                  | 327              | LRD22  | GV2L22            |
| 11   | 15              | 40                  | 15    | 4               | 75                  | -     | -               | -                   | 25                  | 327              | LRD22  | GV2LE22           |
| 11   | 50              | 50                  | 15    | 10              | 75                  | -     | -               | -                   | 25                  | 327              | LRD22  | GV2L22            |
| 15   | 10              | 50                  | 18.5  | 4               | 75                  | 22    | 3               | 75                  | 32                  | 416              | LRD32  | GV2LE32           |
| 15   | 50              | 50                  | 18.5  | 10              | 75                  | 22    | 4               | 100                 | 32                  | 416              | LRD32  | GV2L32            |

H > 100 kA

(1) as % of I<sub>cu</sub>

Common accessories GV2 / GV3, see page 5/15



### Thermal-magnetic circuit-breakers GV3-P for connection by EverLink terminal blocks (2)

#### Control by rotary knob

| Standard power ratings of 3-phase motors 50/60 Hz in category AC-3 |     |         |       |     |         |           |     |         | Setting range | Reference |
|--|-----|---------|-------|-----|---------|-----------|-----|---------|---------------|-----------|
| 400/415 V  |     |         | 500 V |     |         | 660/690 V |     |         | of thermal    |           |
| P  | Icu | Ics (1) | P     | Icu | Ics (1) | P         | Icu | Ics (1) | trips         |           |
| kW   | kA  |         | kW    | kA  |         | kW        | kA  |         | A             |           |
| 5.5  | 100 | 50      | 7.5   | 12  | 50      | 11        | 6   | 50      | 9...13        | GV3P13    |
| 7.5  | 100 | 50      | 11    | 12  | 50      | 15        | 6   | 50      | 12...18       | GV3P18    |
| 11   | 100 | 50      | 15    | 12  | 50      | 18.5      | 6   | 50      | 17...25       | GV3P25    |
| 15   | 100 | 50      | 18.5  | 12  | 50      | 22        | 6   | 50      | 23...32       | GV3P32    |
| 18.5   | 50  | 50      | 22    | 10  | 50      | 30        | 5   | 60      | 30...40       | GV3P40    |
| 22   | 50  | 50      | 30    | 10  | 50      | 37        | 5   | 60      | 37...50       | GV3P50    |
| 30   | 50  | 50      | 37    | 10  | 50      | 45        | 5   | 60      | 48...65       | GV3P65    |

(1) as % of Icu

### Thermal-magnetic circuit-breakers GV3-P for connection by ring terminals

Add the figure 6 to the end of the reference. Example: GV3-P13 becomes GV3-P136

### Thermal-magnetic circuit-breakers GV3-P for connection by only 1 EverLink terminal block

Add the figure 1 to the end of the reference. Example: GV3P65 becomes GV3P651

## Magnetic 11...30 kW with EverLink terminal blocks



### Magnetic circuit-breakers GV3-L for connection by EverLink terminal blocks (2)

#### Control by rotary knob

| Standard power ratings of 3-phase motors 50/60 Hz in category AC-3 |     |     |       |     |     |       |     |     | Associated equipment | Circuit-breaker |           |
|--|-----|-----|-------|-----|-----|-------|-----|-----|----------------------|-----------------|-----------|
| 400/415 V  |     |     | 500 V |     |     | 690 V |     |     | Thermal              | Short-circuit   |           |
| P  | Icu | Ics | P     | Icu | Ics | P     | Icu | Ics | overload             | protection      |           |
| kW   | kA  |     | kW    | kA  |     | kW    | kA  |     | relay                | Rating A        | Reference |
| 11   | 100 | 50  | 15    | 12  | 50  | 18.5  | 6   | 50  | LRD325               | 25              | GV3L25    |
| 15   | 100 | 50  | 18.5  | 12  | 50  | 22    | 6   | 50  | LRD332               | 32              | GV3L32    |
| 18.5   | 50  | 50  | 22    | 10  | 50  | 30    | 5   | 60  | LRD340               | 40              | GV3L40    |
| 22   | 50  | 50  | 30    | 10  | 50  | 45    | 5   | 60  | LRD350               | 50              | GV3L50    |
| 30   | 50  | 50  | 37    | 10  | 50  | 45    | 5   | 60  | LRD365               | 65              | GV3L65    |

### Magnetic circuit-breakers GV3-L for connection by ring terminals

Add the figure 6 to the end of the reference. Example: GV3-L25 becomes GV3-L256

### Magnetic circuit-breakers GV3-L for connection by only 1 EverLink terminal block

Add the figure 1 to the end of the reference. Example: GV3L65 becomes GV3L651

(2) 4 mm BTR screw

## Add-on blocks and accessories (3)

| Add-on blocks (front) | Fault signalling contact + instantaneous auxiliary contact |                 |
|-----------------------|--|-----------------|
| Contact type          | NO (fault) + NC  | NO (fault) + NO |
| References (4)        | GV-AED011  | GV-AED101       |

| Accessories | Cover                       |  |                              | Busbars  |  |  |
|-------------|-----------------------------|--|------------------------------|--|--|--|
| Type        | IP20 for lug type terminals | IP20 for lug type terminals when used with contactor | "Wide spacing" UL 508 type E | Set of 3-pole 115 A busbars for 2 circuit-breakers | Set of 3-pole 115 A busbars for 3 circuit-breakers | "S" form for side by side mounted circuit-breaker/contactors |
| References  | LAD96570                    | LAD96575   | GV3G66                       | GV3G264  | GV3G364  | GV3S   |

(3) Common add-on blocks and accessories GV2 / GV3, see page 5/15

(4) For spring terminal version add 3 to the end of the reference. Example: GV-AED011 becomes GV-AED0113



(TeSys rotating handles)

**Combination block GV2**

|                 |                |               |                          |
|-----------------|----------------|---------------|--------------------------|
| For mounting on | LC1-K or LP1-K | LC1-D09...D38 | LAD-31 and LC1-D09...D38 |
|                 | <b>GV2AF01</b> | <b>GV2AF3</b> | <b>GV2AF4</b>            |

**Sets of 3-pole busbars GV2**

|                    |       |                |                |                |
|--------------------|-------|----------------|----------------|----------------|
| 63 A               | Pitch | 45 mm          | 54 mm          | 72 mm          |
| Number of tap-offs | 2     | <b>GV2G245</b> | <b>GV2G254</b> | <b>GV2G272</b> |
|                    | 3     | <b>GV2G345</b> | <b>GV2G354</b> |                |
|                    | 4     | <b>GV2G445</b> | <b>GV2G454</b> | <b>GV2G472</b> |
|                    | 5     |                | <b>GV2G554</b> |                |

**Protective end cover GV2**

|                           |               |
|---------------------------|---------------|
| For unused busbar outlets | <b>GV1G10</b> |
|---------------------------|---------------|

**Terminal blocks GV2**

|   |                         |  |
|---|-------------------------|--|
| For supply to one or more GV2-G busbar sets | connection from the top | can be fitted with current limiter GV1-L3 (GV2-ME and GV2-P) |
|   | <b>GV1G09</b>           | <b>GV1G05</b>  |

**Padlockable external operator for GV2 and GV3 (150 to 290 mm)**

|              |                            |                   |                |
|--------------|----------------------------|-------------------|----------------|
| Padlocking   | In "On" and "Off" position | In "Off" position |                |
| Handle       | black                      | red               |                |
| Legend plate | blue                       | yellow            |                |
| IP 54        | For GV2-ME/P/L             | <b>GV2AP01</b>    | <b>GV2AP02</b> |
|              | For GV2-LE                 | <b>GV2AP03</b>    | –              |
|              | For GV3-P/L                | <b>GV3AP01</b>    | <b>GV3AP02</b> |

**TeSys rotating handles for**

|                            |                 |                 |
|----------------------------|-----------------|-----------------|
|                            | <b>GV2-P</b>    | <b>GV3-P</b>    |
| Kit IP54 black handle      | <b>GV2APN01</b> | <b>GV3APN01</b> |
| IP54 kit red/yellow handle | <b>GV2APN02</b> | <b>GV3APN02</b> |
| IP65 kit red/yellow handle | <b>GV2APN04</b> | <b>GV3APN04</b> |

**Contact blocks common to GV2 / GV3**

|   | NO + NC      | NO + NC       | NO + NO       | (fault) + NC    | (fault) + NO    | CO common     |
|---|--------------|---------------|---------------|-----------------|-----------------|---------------|
| <b>Instantaneous auxiliary contacts</b>                           |              |               |               |                 |                 | point         |
| Mounting front  | <b>GVAE1</b> | <b>GVAE11</b> | <b>GVAE20</b> |                 |                 |               |
| LH side   |              | <b>GVAN11</b> | <b>GVAN20</b> |                 |                 |               |
| <b>Fault signalling contact + instantaneous auxiliary contact</b> |              |               |               |                 |                 |               |
| LH side NO (fault)  |              |               |               | <b>GVAD1001</b> | <b>GVAD1010</b> |               |
| NC (fault)  |              |               |               | <b>GVAD0101</b> | <b>GVAD0110</b> |               |
| <b>Short-circuit signalling contact</b>                           |              |               |               |                 |                 |               |
| LH side   |              |               |               |                 |                 | <b>GVAM11</b> |

**Electric trips for GV2 and GV3 : undervoltage or shunt (1)**

|   |                |                |
|---|----------------|----------------|
| Side mounting (1 block on RH side of circuit-breaker) | 50 Hz          | 60 Hz          |
| Voltage   |                |                |
| 24 V  | <b>GVA*025</b> | <b>GVA*026</b> |
| 48 V  | <b>GVA*055</b> | <b>GVA*056</b> |
| 100 V   | <b>GVA*107</b> |                |
| 100...110 V   |                | <b>GVA*107</b> |
| 110...115 V   | <b>GVA*115</b> | <b>GVA*116</b> |
| 120...127 V   | <b>GVA*125</b> |                |
| 127 V   |                | <b>GVA*115</b> |
| 200 V   | <b>GVA*207</b> |                |
| 200...220 V   |                | <b>GVA*207</b> |
| 220...240 V   | <b>GVA*225</b> | <b>GVA*226</b> |
| 380...400 V   | <b>GVA*385</b> | <b>GVA*386</b> |
| 415...440 V   | <b>GVA*415</b> |                |
| 415 V   |                | <b>GVA*416</b> |

**Padlocking device**

|  |               |
|--|---------------|
| For use with up to 4 padlocks (padlocks not supplied) Ø 6 mm shank max | <b>GV2V03</b> |
|--|---------------|

(1) Undervoltage trips: replace the • with U, shunt trips: replace the • with S



**Thermal-magnetic circuit-breakers GV7-R for connection by screw clamp terminals**

Control by rocker lever

| Standard power ratings of 3-phase motors 50/60 Hz in category AC-3 |                 |                     |       |                 |                     |           |                 |                     | Setting range | Reference       |
|--|-----------------|---------------------|-------|-----------------|---------------------|-----------|-----------------|---------------------|---------------|-----------------|
| 400/415 V  |                 |                     | 500 V |                 |                     | 660/690 V |                 |                     | of thermal    |                 |
| P  | I <sub>cu</sub> | I <sub>cs</sub> (1) | P     | I <sub>cu</sub> | I <sub>cs</sub> (1) | P         | I <sub>cu</sub> | I <sub>cs</sub> (1) | trips         |                 |
| kW   | kA              |                     | kW    | kA              |                     | kW        | kA              |                     | A             |                 |
| 7.5  | 25              | 100                 | 9     | 18              | 100                 | 11        | 8               | 100                 | 12...20       | <b>GV7RE20</b>  |
| 9  | 25              | 100                 | 11    | 18              | 100                 | 15        | 8               | 100                 |               |                 |
| 7.5  | 70              | 100                 | 9     | 50              | 100                 | 11        | 10              | 100                 | 12...20       | <b>GV7RS20</b>  |
| 9  | 70              | 100                 | 11    | 50              | 100                 | 15        | 10              | 100                 |               |                 |
| 9  | 25              | 100                 | 11    | 18              | 100                 | 15        | 8               | 100                 | 15...25       | <b>GV7RE25</b>  |
| 11   | 25              | 100                 | 15    | 18              | 100                 | 18.5      | 8               | 100                 |               |                 |
| 9  | 70              | 100                 | 11    | 50              | 100                 | 15        | 10              | 100                 | 15...25       | <b>GV7RS25</b>  |
| 11   | 70              | 50                  | 15    | 50              | 100                 | 18.5      | 10              | 100                 |               |                 |
| 18.5   | 25              | 100                 | 18.5  | 18              | 100                 | 22        | 8               | 100                 | 25...40       | <b>GV7RE40</b>  |
|  |                 |                     | 22    | 18              | 100                 |           |                 |                     |               |                 |
| 18.5   | 70              | 100                 | 18.5  | 50              | 100                 | 22        | 10              | 100                 | 25...40       | <b>GV7RS40</b>  |
| 22   | 25              | 100                 | 30    | 18              | 100                 | 30        | 8               | 100                 | 30...50       | <b>GV7RE50</b>  |
| 37   | 25              | 100                 | 45    | 18              | 100                 | 55        | 8               | 100                 | 48...80       | <b>GV7RE80</b>  |
|  |                 |                     | 55    | 18              | 100                 |           |                 |                     |               |                 |
| 37   | 70              | 100                 | 45    | 50              | 100                 | 55        | 10              | 100                 | 48...80       | <b>GV7RS80</b>  |
|  |                 |                     | 55    | 50              | 100                 |           |                 |                     |               |                 |
| 45   | 25              | 100                 | -     | 18              | 100                 | 75        | 8               | 100                 | 60...100      | <b>GV7RE100</b> |
| 45   | 70              | 100                 | -     | 50              | 100                 | 75        | 10              | 100                 | 60...100      | <b>GV7RS100</b> |
| 55   | 35              | 100                 | 75    | 30              | 100                 | 90        | 8               | 100                 | 90...150      | <b>GV7RE150</b> |
| 75   | 70              | 100                 | 90    | 30              | 100                 | 110       | 8               | 100                 |               |                 |
| 55   | 70              | 100                 | 75    | 50              | 100                 | 90        | 10              | 100                 | 90...150      | <b>GV7RS150</b> |
| 75   | 70              | 100                 | 90    | 50              | 100                 | 110       | 10              | 100                 |               |                 |
| 90   | 35              | 100                 | 110   | 30              | 100                 | 160       | 8               | 100                 | 132...220     | <b>GV7RE220</b> |
| 110  | 35              | 100                 | 132   | 30              | 100                 | 200       | 8               | 100                 |               |                 |
|  |                 |                     | 160   | 30              | 100                 |           |                 |                     |               |                 |
| 90   | 70              | 100                 | 110   | 50              | 100                 | 160       | 10              | 100                 | 132...220     | <b>GV7RS220</b> |

(1) as % of I<sub>cu</sub>

4



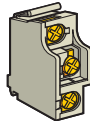

## Add-on blocks

### Contact blocks

#### Auxiliary contacts

|              |                |
|--------------|----------------|
| Contact type | CO             |
|              | <b>GV7AE11</b> |

#### Thermal or magnetic fault discrimination

|  |  |                       |
|--|--|-----------------------|
|  | $\approx$ 24...48 V or $\approx$ 24...72 V | $\approx$ 110...240 V |
|  | <b>GV7AD111</b>                            | <b>GV7AD112</b>       |

### Electric trips

|                              |          |                 |                 |                 |                 |                 |
|------------------------------|----------|-----------------|-----------------|-----------------|-----------------|-----------------|
| Voltage                      | 50/60 Hz | 48 V            | 110... 130 V    | 200... 240 V    | 380...440 V     |                 |
|                              | 50 Hz    |                 |                 |                 |                 | 525 V           |
| <b>Undervoltage trip (1)</b> |          | <b>GV7AU055</b> | <b>GV7AU107</b> | <b>GV7AU207</b> | <b>GV7AU387</b> | <b>GV7AU525</b> |
| <b>Shunt trip (1)</b>        |          | <b>GV7AS055</b> | <b>GV7AS107</b> | <b>GV7AS207</b> | <b>GV7AS387</b> | <b>GV7AS525</b> |

(1) For mounting of a GV7-AD or a GV7-AU or AS

4

## Accessories

#### Terminal shields IP 405

|                                 |                |
|---------------------------------|----------------|
| Supplied with sealing accessory | <b>GV7AC01</b> |
|---------------------------------|----------------|

#### Phase barriers

|  |                |
|--|----------------|
| Safety accessories<br>used when fitting of shields is impossible | <b>GV7AC04</b> |
|--|----------------|

#### Insulating screens

|  |                |
|--|----------------|
| Ensure insulation between<br>the connections and the backplate | <b>GV7AC05</b> |
|--|----------------|

#### Kit for combination with contactor

|   |                  |                  |                   |
|---|------------------|------------------|-------------------|
| Allowing link between the circuit-breaker and the contactor | LC1-F115 to F185 | LC1-F225 and F26 | LC1-D115 and D150 |
|   | <b>GV7AC06</b>   | <b>GV7AC07</b>   | <b>GV7AC08</b>    |

#### Rotary handles

|                  |                |                |
|------------------|----------------|----------------|
| Handle           | black          | red            |
| Legend plate     | black          | yellow         |
| ■ direct IP 40   | <b>GV7AP03</b> | <b>GV7AP04</b> |
| ■ extended IP 55 | <b>GV7AP01</b> | <b>GV7AP02</b> |

#### Conversion accessory

|                                      |                |
|--------------------------------------|----------------|
| for mounting on enclosure door IP 43 | <b>GV7AP05</b> |
|--------------------------------------|----------------|

#### Locking device

|   |               |
|---|---------------|
| For circuit-breaker not fitted with a rotary handle | <b>GV7V01</b> |
|---|---------------|



**Thermal-magnetic circuit-breakers GV3-ME for connection by screw clamp terminals**

**Pushbutton control**

| Standard power ratings of 3-phase motors 50/60 Hz in category AC-3 |                 |                     |       |                 |                     |           |                 |                     | Setting range | Reference      |
|--|-----------------|---------------------|-------|-----------------|---------------------|-----------|-----------------|---------------------|---------------|----------------|
| 400/415 V  |                 |                     | 500 V |                 |                     | 660/690 V |                 |                     | of thermal    |                |
| P  | I <sub>cu</sub> | I <sub>cs</sub> (1) | P     | I <sub>cu</sub> | I <sub>cs</sub> (1) | P         | I <sub>cu</sub> | I <sub>cs</sub> (1) | trips         |                |
| kW   | kA              |                     | kW    | kA              |                     | kW        | kA              |                     | A             |                |
| 37   | 15              | 50                  | 45    | 4               | 100                 | 55        | 2               | 100                 | 56...80       | <b>GV3ME80</b> |

(1) as % of I<sub>cu</sub>

4

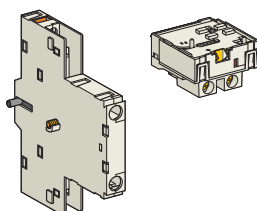

**Add-on blocks for GV3-ME**

**Contact blocks**

| <b>Instantaneous auxiliary contacts</b> (1 per breaker) |               |                 |               |               |               |               |
|---|---------------|-----------------|---------------|---------------|---------------|---------------|
| Normal early break type contacts                        | NC + NO       | NO + NO         | NC + NO + NO  | NO + NO + NO  | NO + NO (1)   | NC + NO (1)   |
|   | <b>GV3A01</b> | <b>GV3A02</b>   | <b>GV3A03</b> | <b>GV3A05</b> | <b>GV3A06</b> | <b>GV3A07</b> |
| <b>Fault signalling contact</b>                         |               |                 |               |               |               |               |
| Normal early break type contacts                        | NC            |                 |               | NO            |               |               |
|   | <b>GV3A08</b> |                 |               | <b>GV3A09</b> |               |               |
| <b>Electric trips</b>                                   |               |                 |               |               |               |               |
| Voltage   | 50 Hz         | 110, 120, 127 V |               | 220, 240 V    |               | 380, 415 V    |
|   | 60 Hz         | 120, 127 V      |               | 277 V         |               | 440, 480 V    |
| <b>Undervoltage trip</b>                                | <b>GV3B11</b> |                 | <b>GV3B22</b> |               | <b>GV3B38</b> |               |
| <b>Shunt trip</b>                                       | <b>GV3D11</b> |                 | <b>GV3D22</b> |               | <b>GV3D38</b> |               |
| <b>Padlocking device</b>                                |               |                 |               |               |               |               |
| Start button (for bare device)                          | <b>GV1V02</b> |                 |               |               |               |               |

(1) + 2 volt free terminals



**Magnetic circuit-breakers GK3-EF for connection by screw clamp terminals**

**Control by rotary knob**

| Standard power ratings of 3-phase motors 50/60 Hz in category AC-3 |                 |                 |       |                 |                 |       |                 |                 | Associated equipment | Circuit-breaker |                |
|--|-----------------|-----------------|-------|-----------------|-----------------|-------|-----------------|-----------------|----------------------|-----------------|----------------|
| 400/415 V  |                 |                 | 500 V |                 |                 | 690 V |                 |                 | Thermal              | Short-circuit   |                |
| P  | I <sub>cu</sub> | I <sub>cs</sub> | P     | I <sub>cu</sub> | I <sub>cs</sub> | P     | I <sub>cu</sub> | I <sub>cs</sub> | overload relay       | protection      |                |
| kW   | kA              |                 | kW    | kA              |                 | kW    | kA              |                 | min. size            | Rating A        | Reference      |
| 37   | 35              | 25              | 45    | 15              | 30              | -     | -               | -               | LRD-3363             | 80              | <b>GK3EF80</b> |

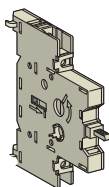

**Add-on blocks for GK3**

**Contact blocks**

| Contact type  | NO             | NO + NO        | NC + NO        | NC            | NO            |
|---|----------------|----------------|----------------|---------------|---------------|
| <b>On-Off signalling contacts</b><br>and "Control circuit test" function (1 or 2 blocks per device)<br>mounted on RH side of GK3-EF | <b>GK2AX10</b> | <b>GK2AX20</b> | <b>GK2AX50</b> |               |               |
| <b>Instantaneous fault signalling contacts</b><br>(1 or 2 blocks per device) mounted on LH side of GK3-EF                           | <b>GK2AX12</b> | <b>GK2AX22</b> | <b>GK2AX52</b> |               |               |
| <b>Fault signalling contact (1)</b>   |                |                |                | <b>GV3A08</b> | <b>GV3A09</b> |

(1) 1 trip OR 1 fault signalling contact to be fitted inside the circuit-breaker.

**Accessories for GK3**

**Padlocking device**

|   |                |
|---|----------------|
| for padlocking the operator with up to 3 padlocks (padlocks not supplied) | <b>GK3AV01</b> |
|---|----------------|

**External operator**

|   |                |
|---|----------------|
| for mounting on enclosure door.<br>Red Ø 40 pushbutton on yellow plate, can be locked in position O by means of up to 3 padlocks with door locked in position I, and door locked in position O when padlocked | <b>GK3AP03</b> |
|---|----------------|

# TeSys DF Fuse carriers

## 0...125 A



| Type                               |                 |      | Fuse carriers without "blown fuse" indicator |            |            |            |
|------------------------------------|-----------------|------|--|------------|------------|------------|
| Rated insulation voltage (Ui)      |                 |      | 500 V  | 690 V      |            |            |
| Fuse size                          |                 |      | 8.5 x 31.5 mm                                | 10 x 38 mm | 14 x 51 mm | 22 x 58 mm |
| Conventional thermal current (Ith) |                 |      | 25 A   | 32 A       | 50 A       | 125 A      |
| References                         | Number of poles | 1P   | DF81   | DF101      | DF141      | DF221      |
|                                    |                 | N    | DF10N  | DF10N      | DF14N      | DF22N      |
|                                    |                 | 1P+N | DF81N  | DF101N     | DF141N     | DF221N     |
|                                    |                 | 2P   | DF82   | DF102      | DF142      | DF222      |
|                                    |                 | 3P   | DF83   | DF103      | DF143C     | DF223C     |
|                                    |                 | 3P+N | DF83N  | DF103N     | DF143NC    | DF223NC    |

4



| Type                               |                 |        | Fuse carriers with "blown fuse" indicator |            |            |            |
|------------------------------------|-----------------|--------|---|------------|------------|------------|
| Rated insulation voltage (Ui)      |                 |        | 500 V                                     | 690 V      |            |            |
| Fuse size                          |                 |        | 8.5 x 31.5 mm                             | 10 x 38 mm | 14 x 51 mm | 22 x 58 mm |
| Conventional thermal current (Ith) |                 |        | 25 A                                      | 32 A       | 50 A       | 125 A      |
| References                         | Number of poles | 1P     | DF81V                                     | DF101V     | DF141V     | DF221V     |
|                                    |                 | 1P + N | DF81NV                                    | DF10NV     | DF14NV     | DF22NV     |
|                                    |                 | 2P     | DF82V                                     | DF102V     | DF142V     | DF222V     |
|                                    |                 | 3P     | DF83V                                     | DF103V     | DF143VC    | DF223VC    |
|                                    |                 | 3P + N | DF83NV                                    | DF103NV    | DF143NVC   | DF223NVC   |

## Accessories

| Type                        | Auxiliary early break and blown fuse signalling contacts |         |              |         |
|-----------------------------|--|---------|--------------|---------|
| Fuse carrier to be equipped | DF14   |         | DF22         |         |
| Fuse size                   | 14 x 51 mm   |         | 22 x 58 mm   |         |
| Number of poles             | 3P or 3P + N   |         | 3P or 3P + N |         |
| Number of contacts          | 1  | 2       | 1            | 2       |
| References                  | DF14AM1  | DF14AM2 | DF22AM1      | DF22AM2 |

| Type                         | Fuse carrier assembly kits |            |                |            |
|------------------------------|----------------------------|------------|----------------|------------|
| Fuse carrier to be assembled | DF8                        | DF10       | DF14           | DF22       |
| Fuse size                    | 8.5 x 31.5 mm              | 10 x 38 mm | 14 x 51 mm     | 22 x 58 mm |
| Kit contents                 | 1 pin, 2 clips             |            | 1 pin, 3 clips |            |
| References                   | DF10AP                     |            | DF14AP         | DF22AP     |



| Type                           | 3-pole fuse carriers |               |                                     |              |              |              |
|--------------------------------|----------------------|---------------|-------------------------------------|--------------|--------------|--------------|
| Rated insulation voltage (Ui)  | 690 V                |               |                                     |              |              |              |
| Rating                         | 25 A                 | 32 A          | 50 A                                |              | 125 A        |              |
| Fuse size                      | 10 x 38              | 10 x 38       | 14 x 51                             |              | 22 x 58      |              |
| Connection                     | Spring terminals     |               | Screw clamp terminals or connectors |              |              |              |
| Single-phase protection device | Without              |               | Without                             | With         | Without      | With         |
| Number of early break contacts | –                    |               | –                                   | 1            | 1            | 1            |
| Reference                      | <b>LS1D323</b>       | <b>LS1D32</b> | <b>GK1K</b>                         | <b>GK1EV</b> | <b>GK1FK</b> | <b>GK1FV</b> |
| Number of early break contacts |                      |               | 2                                   |              | 2            |              |
| Reference                      |                      |               | <b>GK1ES</b>                        | <b>GK1EW</b> | <b>GK1FS</b> | <b>GK1FW</b> |



| Type                           | 4-pole fuse carriers                |              |              |              |              |
|--------------------------------|-------------------------------------|--------------|--------------|--------------|--------------|
| Rated insulation voltage (Ui)  | 690 V                               |              |              |              |              |
| Rating                         | 32 A                                | 50 A         |              | 125 A        |              |
| Fuse size                      | 10 x 38                             | 14 x 51      |              | 22 x 58      |              |
| Connection                     | Screw clamp terminals or connectors |              |              |              |              |
| Single-phase protection device | Without                             | Without      | With         | Without      | With         |
| Number of early break contacts | –                                   | 1            |              | 1            |              |
| Reference                      | <b>LS1D32 + LA8D324</b>             | <b>GK1EM</b> | <b>GK1EY</b> | <b>GK1FM</b> | <b>GK1FY</b> |
| Number of early break contacts |                                     | 2            |              | 2            |              |
| Reference                      |                                     | <b>GK1ET</b> | <b>GK1EX</b> | <b>GK1FT</b> | <b>GK1FX</b> |



| Type                      | Early break auxiliary contact blocks |         |         |         |
|---------------------------|--------------------------------------|---------|---------|---------|
| Fuse carrier rating       | 32 A                                 |         | 25 A    |         |
| For use with fuse carrier | LS1D32                               |         | LS1D323 |         |
| Contact type              | NO + NC                              | NO + NO | NO + NC | NO + NO |
| References                | GVAE11                               | GVAE20  | GVAE113 | GVAE203 |

4

| Type                | Direct operator handle |         |                    |
|---------------------|------------------------|---------|--------------------|
| Fuse carrier rating | 125 A                  |         | 32, 50, 125 A      |
| For mounting on     | RH side                | LH side | Front              |
| References          | GK1AP07                | GK1AP08 | Fitted as standard |

| Type                | External operator handle |           |         |         |         |         |
|---------------------|--------------------------|-----------|---------|---------|---------|---------|
| Fuse carrier rating | 32 A                     |           | 50 A    |         | 125 A   |         |
| For mounting on     | RH side                  | LH side   | RH side | LH side | RH side | LH side |
| References          | LS1D32005                | LS1D32006 | GK1AP05 | GK1AP06 | GK1AP07 | GK1AP08 |

| Type                           | Padlocking devices |         |         |         |         |
|--------------------------------|--------------------|---------|---------|---------|---------|
| Fuse carrier rating            | 32 A               |         | 50 A    |         |         |
| Number of poles                | 3 or 4             |         | 3       |         | 4       |
| Single-phase protection device | Without            | Without | With    | Without | With    |
| References                     | Integrated         | GK1AV07 | GK1AV08 | GK1AV08 | GK1AV09 |

| Type                | Tubular link |         |        |
|---------------------|--------------|---------|--------|
| Fuse carrier rating | 32 A         |         | 125 A  |
| References          | DK1CB92      | DK1EB92 | DK1FA9 |

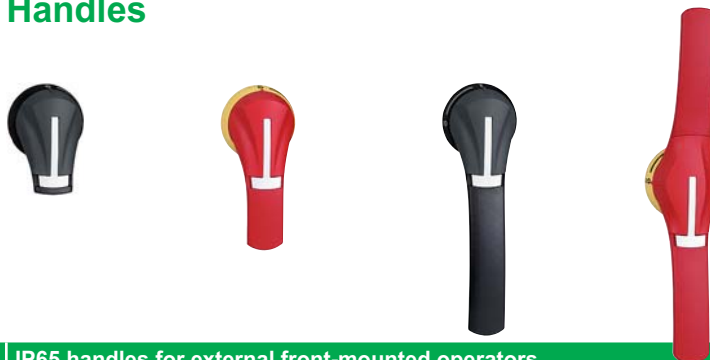

| Type          |            | IP65 handles for external front-mounted operators |              |             |          |
|---------------|------------|---|--------------|-------------|----------|
| Switch rating |            | 32...63 A   | 100...400 A  | 630...800 A | 1250 A   |
| References    | Black/grey | GS2AH510 (1)                                      | GS2AH530 (1) | GS2AH550    | GS2AH570 |
|               | Red/yellow | GS2AH520 (1)                                      | GS2AH540 (1) | GS2AH560    | GS2AH580 |

(1) For external front operators with Test facility, insert the letter T in the reference. Example: GS2AH510 becomes GS2AHT510

| Type          |            | IP65 handles for external RH side-mounted operators (2) |             |              |
|---------------|------------|---|-------------|--------------|
| Switch rating |            | 32...63 A   | 100...400 A | 630...1250 A |
| References    | Black/grey | GS2AH210  | GS2AH230    | GS2AH250     |
|               | Red/yellow | GS2AH220  | GS2AH240    | GS2AH260     |

(2) For external LH side-mounted operators, replace the number 2 in the reference by 3. Example: GS2AH210 becomes GS2AH310

| Type          |                 | Shafts for external operators |            |              |         |
|---------------|-----------------|-------------------------------|------------|--------------|---------|
| Switch rating |                 | 32 A                          | 50...400 A | 630...1250 A |         |
| References    | Length of shaft | 200 mm                        | GS2AE82    | GS2AE22      | GS2AE52 |
|               |                 | 320 mm                        | GS2AE8     | GS2AE2       | GS2AE5  |
|               |                 | 400 mm                        | GS2AE81    | GS2AE21      | GS2AE51 |



| Type             |  | Handles for direct operators |             |             |               |          |
|------------------|--|------------------------------|-------------|-------------|---------------|----------|
| Switch rating    |  | 32 A                         | 50 and 63 A | 100...400 A | 630 and 800 A | 1250 A   |
| Type of operator |  | Front                        | RH side     | RH side     | Front         | Front    |
| References       |  | GS1AH103                     | GS1AH01     | GS1AH02     | GS2AH104      | GS2AH105 |



| Type  | Switch-disconnector-fuse switch bodies for use with NF C or DIN fuses<br>Handle to be ordered separately (see previous page) |         |              |         |
|---|--|---------|--------------|---------|
| Rated insulation voltage (Ui)                       | 690 V  |         |              |         |
| Conventional thermal current (Ith)                  | 32 A   | 50 A    | 63 A         | 100 A   |
| Fuse size   | 10 x 38  | 14 x 51 | Size 00C (1) | 22 x 58 |
| External front-mounted and RH side-mounted operator | 3-pole<br>GS1DD3   | GS2F3   | GS2G3        | GS2J3   |
| External LH side-mounted operator                   | 4-pole<br>GS1DD4 (2)   | GS2F4   | GS2G4        | GS2J4   |
| Direct RH side-mounted operator                     | 3-pole<br>GS1DD3 (3)   | GS1FD3  | GS1GD3       | GS1JD3  |
|   | 4-pole<br>GS1DD4 (2) (3)   | GS1FD4  | GS1GD4       | GS1JD4  |

(1) Compact fuse for German market

(2) 3-pole + switched neutral

(3) Direct front-mounted operator

| Type  | Switch-disconnector-fuse switch bodies for use with BS fuses<br>Handle to be ordered separately (see previous page) |        |        |                |
|---|---|--------|--------|----------------|
| Rated insulation voltage (Ui)                       | 690 V   |        |        |                |
| Conventional thermal current (Ith)                  | 32 A  | 32 A   | 63 A   | 100 A          |
| Fuse size   | A1  | A1     | A2-A3  | A4 (Ø ≤ 31 mm) |
| External front-mounted and RH side-mounted operator | 3-pole<br>GS1DDB3   | GS2DB3 | GS2GB3 | GS2JB3         |
|   | 4-pole<br>GS1DDB4 (2)   | GS2DB4 | GS2GB4 | GS2JB4         |

## Accessories

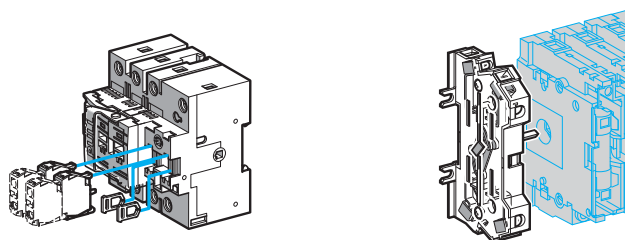

| Type               | Auxiliary contacts<br>Early break and/or O, I and Test signalling   O and I signalling |          |             |             |
|--------------------|--|----------|-------------|-------------|
| Switch rating      | 32...1250 A  |          | 50...1250 A |             |
| Number of contacts | 1 NO   | 1 NC     | 1 NO + NC   | 2 NO + 2 NC |
| Operator           | external front-mounted or RH side-mounted  | GS1AM110 | GS1AM101    | GS1AN11     |
|                    | external LH side-mounted   | GS1AM110 | GS1AM101    | GS1AN11G    |
|                    | direct RH side-mounted   | –        | –           | GS1AN11     |
|                    | direct front-mounted   | –        | –           | –           |

| Type               | Auxiliary “blown fuse” signalling contacts for use with NF C and DIN fuses |               |         |                   |
|--------------------|--|---------------|---------|-------------------|
| Number of contacts | 1 NO/NC  |               |         |                   |
| Switch rating      | 50 A   | 100 and 125 A | 160 A   | 250 and 400 A     |
| Fuse size          | 14 x 51  | 22 x 58       | Size 0  | Size 1 and Size 2 |
| References         | 3-pole<br>GS1AF1   | GS1AF23       | GS1AF33 | GS1AF43           |
|                    | 4-pole<br>GS1AF1   | GS1AF24       | GS1AF34 | GS1AF44           |





| 125 A         |                | 160 A          |               | 250 A         | 400 A          | 630 A            | 1250 A           |
|---------------|----------------|----------------|---------------|---------------|----------------|------------------|------------------|
| 22 x 58       | Size 00        | Size 00        | Size 0        | Size 1        | Size 2         | Size 3           | Size 4           |
| <b>GS2K3</b>  | <b>GS2KK3</b>  | <b>GS2LL3</b>  | <b>GS2L3</b>  | <b>GS2N3</b>  | <b>GS2QQ3</b>  | <b>GS2S3</b>     | <b>GS2V3</b>     |
| <b>GS2K4</b>  | <b>GS2KK4</b>  | <b>GS2LL4</b>  | <b>GS2L4</b>  | <b>GS2N4</b>  | <b>GS2QQ4</b>  | <b>GS2S4</b>     | <b>GS2V4</b>     |
| <b>GS2KG3</b> | <b>GS2KKG3</b> | <b>GS2LLG3</b> | <b>GS2LG3</b> | <b>GS2NG3</b> | <b>GS2QGG3</b> | <b>GS2SG3</b>    | <b>GS2VG3</b>    |
| <b>GS2KG4</b> | <b>GS2KKG4</b> | <b>GS2LLG4</b> | <b>GS2LG4</b> | <b>GS2NG4</b> | <b>GS2QGG4</b> | <b>GS2SG4</b>    | <b>GS2VG4</b>    |
| <b>GS1KD3</b> | <b>GS1KKD3</b> | <b>GS1LLD3</b> | <b>GS1LD3</b> | <b>GS1ND3</b> | <b>GS1QDD3</b> | <b>GS2S3 (3)</b> | <b>GS2V3 (3)</b> |
| <b>GS1KD4</b> | <b>GS1KKD4</b> | <b>GS1LLD4</b> | <b>GS1LD4</b> | <b>GS1ND4</b> | <b>GS1QDD4</b> | <b>GS2S4 (3)</b> | <b>GS2V4 (3)</b> |

| 160 A          |               | 200 A          | 250 A         | 315 A          | 400 A          | 630 A         | 800 A         | 1250 A        |
|----------------|---------------|----------------|---------------|----------------|----------------|---------------|---------------|---------------|
| A4             | B1-B2         | B1-B2          | B1...B3       | B1...B3        | B1...B4        | C1-C2         | C1...C3       | D1            |
| <b>GS2LLB3</b> | <b>GS2LB3</b> | <b>GS2MMB3</b> | <b>GS2NB3</b> | <b>GS2PPB3</b> | <b>GS2QQB3</b> | <b>GS2SB3</b> | <b>GS2TB3</b> | <b>GS2VB3</b> |
| <b>GS2LLB4</b> | <b>GS2LB4</b> | <b>GS2MMB4</b> | <b>GS2NB4</b> | <b>GS2PPB4</b> | <b>GS2QQB4</b> | <b>GS2SB4</b> | <b>GS2TB4</b> | <b>GS2VB4</b> |

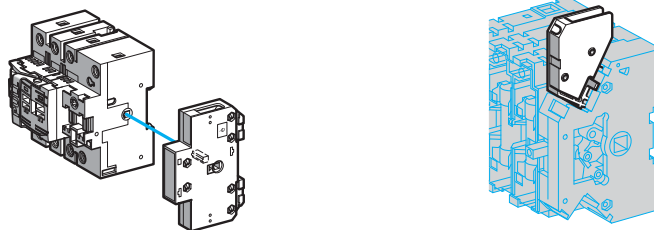

| O, I and Test signalling |                 | Early break and O and I signalling |                 |               |               |
|--------------------------|-----------------|------------------------------------|-----------------|---------------|---------------|
| 50...400 A               |                 | 32 A                               |                 | 50...400 A    |               |
| 1 NO + NC                | 2 NO + 2 NC     | 1 NO/NC                            | 2 NO/NC         | 1 NO/NC       | 2 NO/NC       |
| <b>GS1ANT11</b>          | <b>GS1ANT22</b> | –                                  | –               | –             | –             |
| –                        | –               | –                                  | –               | <b>GS1AM1</b> | <b>GS1AM2</b> |
| –                        | –               | <b>GS1AM111</b>                    | <b>GS1AM211</b> | –             | –             |

| 630 A          | 1250 A         | 2 <sup>nd</sup> NO/NC |
|----------------|----------------|-----------------------|
| Size 3         | Size 4         | 50...1250 A           |
| <b>GS2AF63</b> | <b>GS2AF73</b> | <b>GS1AF</b>          |
| <b>GS2AF64</b> | <b>GS2AF74</b> | <b>GS1AF</b>          |



## Thermal overload relays, TeSys K adjustable from 0.11 to 12 A

Connection by screw clamp terminals, direct mounting on contactors LC1-K, manual or automatic reset

| Relay setting range | Fuses to be used with selected relay |       |      | Reference |
|---------------------|--------------------------------------|-------|------|-----------|
|                     | aM                                   | gG    | BS88 |           |
| Class 10A           |                                      |       |      |           |
| 0.11...0.16 A       | 0.25 A                               | 0.5 A | -    | LR2K0301  |
| 0.16...0.23 A       | 0.25 A                               | 0.5 A | -    | LR2K0302  |
| 0.23...0.36 A       | 0.5 A                                | 1 A   | -    | LR2K0303  |
| 0.36...0.54 A       | 1 A                                  | 1.6 A | -    | LR2K0304  |
| 0.54...0.8 A        | 1 A                                  | 2 A   | -    | LR2K0305  |
| 0.8...1.2 A         | 2 A                                  | 4 A   | 6 A  | LR2K0306  |
| 1.2...1.8 A         | 2 A                                  | 6 A   | 6 A  | LR2K0307  |
| 1.8...2.6 A         | 2 A                                  | 6 A   | 10 A | LR2K0308  |
| 2.6...3.7 A         | 4 A                                  | 10 A  | 16 A | LR2K0310  |
| 3.7...5.5 A         | 6 A                                  | 16 A  | 16 A | LR2K0312  |
| 5.5...8 A           | 8 A                                  | 20 A  | 20 A | LR2K0314  |
| 8...11.5 A          | 10 A                                 | 25 A  | 20 A | LR2K0316  |

Thermal overload relays for use on class 10A unbalanced loads: for above references LR2-K0305 to LR2-K0316 only, replace the prefix LR2 with LR7.

Example: LR7-K0310.

## Accessories

### Prewiring kit

| Allowing direct connection of the NC contact of relay LRD-01...35 or LR3-D01... D35 to the contactor | For use on   |        |
|--|--------------|--------|
|  | LC1D09...D18 | LAD7C1 |
|  | LC1D25...D38 | LAD7C2 |

### Terminal blocks (1)

| For clip-on mounting on 35 mm mounting rail (AM1-DP200) or screw fixing | LRD01...35 and LR3D01...D35 | LAD7B10      |
|---|-----------------------------|--------------|
|   | LRD3***, LR3D3***, LRD35**  | LA7D3064 (2) |
| For independent mounting of the relay                                   | LR2K****                    | LA7K0064     |

### EverLink Terminal blocks

| Separate terminal block | LRD313... LRD365 | LAD9R3 |
|-------------------------|------------------|--------|
|-------------------------|------------------|--------|

### Terminal block adapter

| For mounting a relay beneath an LC1-D115 or D150 contactor | LRD3***, LR3D3***, LRD35** | LA7D3058 |
|--|----------------------------|----------|
|--|----------------------------|----------|

### Stop or electrical reset

| Remote (3) | LRD01...35 and LR3D01...D35 | LAD703• (4) |
|------------|-----------------------------|-------------|
|------------|-----------------------------|-------------|

### Tripping or electrical reset device

| Remote (3) | All relays except LRD01...35 and LR3D01...D35 | LA7D03• (4) |
|------------|---|-------------|
|------------|---|-------------|

(1) Terminal blocks are supplied with terminals protected against direct finger contact and screws in the open "ready-to-tighten" position.

(2) To order a terminal block for connection by lug-clamps, the reference becomes LA7-D30646.

(3) The time for which the coil of remote tripping or electrical resetting device LA7-D03 or LAD-703 can remain energised depends on its rest time: 1 s pulse duration with 9 s rest time; maximum pulse duration of 20 s with a rest time of 300 s. Minimum pulse time 200 ms.

(4) Reference to be completed by adding the code indicating the control circuit voltage.

## Standard control circuit voltages

### ~ supply

| Volts   | 12 | 24 | 48 | 96 | 110 | 220/230 | 380/400 | 415/440 |
|---|----|----|----|----|-----|---------|---------|---------|
| 50/60 Hz. Consumption, inrush and sealed < 100 VA | -  | B  | E  | -  | F   | M       | Q       | N       |

### ≡ supply

| Consumption, inrush and sealed < 100 W | J | B | E | DD | F | M | - | - |
|--|---|---|---|----|---|---|---|---|
|--|---|---|---|----|---|---|---|---|



## Thermal overload relays, TeSys D

adjustable from 0.1 to 140 A

Compensated relays with manual or automatic reset, with relay trip indicator, for a.c. or d.c.

| Connection by screw clamp terminals or connectors | Relay setting range  | Fuses to be used with selected relay |       |                  | With contactor      | Reference           |                    |
|---|--|--------------------------------------|-------|------------------|---------------------|---------------------|--------------------|
|   |  | aM                                   | gG    | BS88             |                     |                     |                    |
| <b>Class 10A</b>                                  | 0.10...0.16 A  | 0.25 A                               | 2 A   | -                | LC1D09...D38        | <b>LRD01</b> (1)    |                    |
|   | 0.16...0.25 A  | 0.5 A                                | 2 A   | -                | LC1D09...D38        | <b>LRD02</b> (1)    |                    |
|   | 0.25...0.40 A  | 1 A                                  | 2 A   | -                | LC1D09...D38        | <b>LRD03</b> (1)    |                    |
|   | 0.40...0.63 A  | 1 A                                  | 1.6 A | -                | LC1D09...D38        | <b>LRD04</b> (1)    |                    |
|   | 0.63...1 A   | 2 A                                  | 4 A   | -                | LC1D09...D38        | <b>LRD05</b> (1)    |                    |
|   | 1...1.7 A  | 2 A                                  | 4 A   | 6 A              | LC1D09...D38        | <b>LRD06</b> (1)    |                    |
|   | 1.6...2.5 A  | 4 A                                  | 6 A   | 10 A             | LC1D09...D38        | <b>LRD07</b> (1)    |                    |
|   | 2.5...4 A  | 6 A                                  | 10 A  | 16 A             | LC1D09...D38        | <b>LRD08</b> (1)    |                    |
|   | 4...6 A  | 8 A                                  | 16 A  | 16 A             | LC1D09...D38        | <b>LRD10</b> (1)    |                    |
|   | 5.5...8 A  | 12 A                                 | 20 A  | 20 A             | LC1D09...D38        | <b>LRD12</b> (1)    |                    |
|   | 7...10 A   | 12 A                                 | 20 A  | 20 A             | LC1D09...D38        | <b>LRD14</b> (1)    |                    |
|   | 9...13 A   | 16 A                                 | 25 A  | 25 A             | LC1D12...D38        | <b>LRD16</b> (1)    |                    |
|   | 12...18 A  | 20 A                                 | 35 A  | 32 A             | LC1D18...D38        | <b>LRD21</b> (1)    |                    |
|   | 16...24 A  | 25 A                                 | 50 A  | 50 A             | LC1D25...D38        | <b>LRD22</b> (1)    |                    |
|   | 23...32 A  | 40 A                                 | 63 A  | 63 A             | LC1D25...D38        | <b>LRD32</b> (1)    |                    |
|   | 30...38 A  | 50 A                                 | 80 A  | 80 A             | LC1D32 and D38      | <b>LRD35</b> (1)    |                    |
|   | 55...70 A  | 80 A                                 | 125 A | 125 A            | D50...D95           | <b>LRD3361</b> (1)  |                    |
|   | 63...80 A  | 80 A                                 | 125 A | 125 A            | D65...D95           | <b>LRD3363</b> (1)  |                    |
|   | 80...104 A   | 100 A                                | 160 A | 160 A            | D80 and D95         | <b>LRD3365</b> (1)  |                    |
|   | 80...104 A   | 125 A                                | 200 A | 160 A            | D115 and D150       | <b>LRD4365</b> (1)  |                    |
| 95...120 A  | 125 A  | 200 A                                | 200 A | D115 and D150    | <b>LRD4367</b> (1)  |                     |                    |
| 110...140 A                                       | 160 A  | 250 A                                | 200 A | D150             | <b>LRD4369</b> (1)  |                     |                    |
| 80...104 A  | 100 A  | 160 A                                | 160 A | Independent mtg. | <b>LRD33656</b> (1) |                     |                    |
| 95...120 A  | 125 A  | 200 A                                | 200 A | Independent mtg. | <b>LRD33676</b> (1) |                     |                    |
| 110...140 A                                       | 160 A  | 250 A                                | 200 A | Independent mtg. | <b>LRD33696</b> (1) |                     |                    |
| <b>Class 20</b>                                   | 6 A  | 10 A                                 | 16 A  | -                | LC1D09...D32        | <b>LRD1508</b> (1)  |                    |
|   | 4...6 A  | 8 A                                  | 16 A  | 16 A             | LC1D09...D32        | <b>LRD1510</b> (1)  |                    |
|   | 5.5...8 A  | 12 A                                 | 20 A  | 20 A             | LC1D09...D32        | <b>LRD1512</b> (1)  |                    |
|   | 7...10 A   | 16 A                                 | 20 A  | 25 A             | LC1D09...D32        | <b>LRD1514</b> (1)  |                    |
|   | 9...13 A   | 16 A                                 | 25 A  | 25 A             | LC1D12...D32        | <b>LRD1516</b> (1)  |                    |
|   | 12...18 A  | 25 A                                 | 35 A  | 40 A             | LC1D18...D32        | <b>LRD1521</b> (1)  |                    |
|   | 17...25 A  | 32 A                                 | 50 A  | 50 A             | LC1D25 and D32      | <b>LRD1522</b> (1)  |                    |
|   | 23...28 A  | 40 A                                 | 63 A  | 63 A             | LC1D25 and D32      | <b>LRD1530</b> (1)  |                    |
|   | 25...32 A  | 40 A                                 | 63 A  | 63 A             | LC1D25 and D32      | <b>LRD1532</b> (1)  |                    |
|   | 55...70 A  | 100 A                                | 125 A | 125 A            | D65...D95           | <b>LR2D3561</b> (1) |                    |
|   | 63...80 A  | 100 A                                | 160 A | 125 A            | D80 and D95         | <b>LR2D3563</b> (1) |                    |
|   | <b>Connection by EverLink terminal blocks, with BTR screws</b> |                                      |       |                  |                     |                     |                    |
|   | <b>Class 10A</b>   | 9...13 A                             | 16 A  | 25 A             | 25 A                | LC1D40A...D65A      | <b>LRD313</b> (2)  |
| 12...18 A   |  | 20 A                                 | 32 A  | 35 A             | LC1D40A...D65A      | <b>LRD318</b> (2)   |                    |
| 17...25 A   |  | 25 A                                 | 50 A  | 50 A             | LC1D40A...D65A      | <b>LRD325</b> (2)   |                    |
| 23...32 A   |  | 40 A                                 | 63 A  | 63 A             | LC1D40A...D65A      | <b>LRD332</b> (2)   |                    |
| 30...40 A   |  | 40 A                                 | 80 A  | 80 A             | LC1D40A...D65A      | <b>LRD340</b> (2)   |                    |
| 37...50 A   |  | 63 A                                 | 100 A | 100 A            | LC1D40A...D65A      | <b>LRD350</b> (2)   |                    |
| 48...65 A   |  | 63 A                                 | 100 A | 100 A            | LC1D40A...D65A      | <b>LRD365</b> (2)   |                    |
| <b>Class 20</b>                                   |  | 9...13 A                             | 20 A  | 32 A             | 35 A                | LC1D40A...D65A      | <b>LRD313L</b> (2) |
|   | 12...18 A  | 25 A                                 | 40 A  | 40 A             | LC1D40A...D65A      | <b>LRD318L</b> (2)  |                    |
|   | 17...25 A  | 32 A                                 | 50 A  | 50 A             | LC1D40A...D65A      | <b>LRD325L</b> (2)  |                    |
|   | 23...32 A  | 40 A                                 | 63 A  | 63 A             | LC1D40A...D65A      | <b>LRD332L</b> (2)  |                    |
|   | 30...40 A  | 50 A                                 | 80 A  | 80 A             | LC1D40A...D65A      | <b>LRD340L</b> (2)  |                    |
|   | 37...50 A  | 63 A                                 | 100 A | 100 A            | LC1D40A...D65A      | <b>LRD350L</b> (2)  |                    |
|   | 48...65 A  | 80 A                                 | 125 A | 125 A            | LC1D40A...D65A      | <b>LRD365L</b> (2)  |                    |

### Class 10A with connection by lug-clamps:

Select overload relay with screw clamp terminals or connectors from the table above and add one of the following suffixes:

■ figure 6 for relays LRD01 to LRD35 and LRD313 to LRD365.

■ A66 for relays LRD3361 to LRD3365.

Relays LRD43 are suitable as standard, for use with lug-clamps.

(1) For independent mounting on a DIN rail, order an EverLink LAD7B106 terminal block.

### Thermal overload relays for use with unbalanced loads Class 10A

with connection by screw clamp terminals and lug-clamp terminals:

In the reference selected above, change LRD(except LRD4●●●) to LR3D

Example: LRD01 becomes **LR3D 01**

Example with EverLink terminals: LRD340 becomes **LR3D 340**

Example with lug-clamp terminals: LRD3406 becomes **LR3D 3406**

(2) For independent mtg. on a DIN rail, order an EverLink LAD96560 terminal block.



|   |             |             |
|---|-------------|-------------|
| For use with contactor                  | LC1-D       | LC1-F       |
| Motor current                           | 60...150 A  | 30...630 A  |
| <b>Basic reference, to be completed</b> | <b>LR9D</b> | <b>LR9F</b> |

4

| Relay setting range | Fuse to be used with selected relay |     | For mounting<br>beneath contactor LC1- | Compensated and differential |                 | With alarm    |
|---------------------|-------------------------------------|-----|--|------------------------------|-----------------|---------------|
|                     | aM                                  | gG  |  | Class 10                     | Class 20        |               |
| 60...100            | 100                                 | 160 | D115 and D150                          | <b>LR9D5367</b>              | <b>LR9D5567</b> |               |
| 90...150            | 160                                 | 250 | D115 and D150                          | <b>LR9D5369</b>              | <b>LR9D5569</b> |               |
| 30...50             | 50                                  | 80  | F115...F185                            | <b>LR9F5357</b>              | <b>LR9F5557</b> | <b>LR9F57</b> |
| 48...80             | 80                                  | 125 | F115...F185                            | <b>LR9F5363</b>              | <b>LR9F5563</b> | <b>LR9F63</b> |
| 60...100            | 100                                 | 200 | F115...F185                            | <b>LR9F5367</b>              | <b>LR9F5567</b> | <b>LR9F67</b> |
| 90...150            | 160                                 | 250 | F115...F185                            | <b>LR9F5369</b>              | <b>LR9F5569</b> | <b>LR9F69</b> |
| 132...220           | 250                                 | 315 | F185...F400                            | <b>LR9F5371</b>              | <b>LR9F5571</b> | <b>LR9F71</b> |
| 200...330           | 400                                 | 500 | F225...F500                            | <b>LR9F7375</b>              | <b>LR9F7575</b> | <b>LR9F75</b> |
| 300...500           | 500                                 | 800 | F225...F500                            | <b>LR9F7379</b>              | <b>LR9F7579</b> | <b>LR9F79</b> |
| 380...630           | 630                                 | 800 | F400...F630 and F800                   | <b>LR9F7381</b>              | <b>LR9F7581</b> | <b>LR9F81</b> |

| Accessories  |                   |                   |
|--|-------------------|-------------------|
| <b>Remote control</b>  |                   |                   |
| Function   | Reset             | Stop and/or Reset |
| Electrical reset (1)   | <b>LA7D03•(2)</b> |                   |
| Reset by flexible cable (length 0.5 m)                           | <b>LA7D305</b>    |                   |
| Adapter for door interlock mechanism                             |                   | <b>LA7D1020</b>   |
| <b>Operating head for pushbutton</b>                             |                   |                   |
| Spring return  | <b>ZA2BL639</b>   | <b>ZA2BL432</b>   |
| <b>Rod with snap-off end</b>                                     |                   |                   |
| Adjustable from 17 to 120 mm                                     | <b>ZA2BZ13</b>    |                   |
| <b>Insulated terminal blocks</b>                                 |                   |                   |
| For relays LR9-F5•57, F5•63, F5•67, F5•69, F57, F63, F67 and F69 | Set of 2 blocks   |                   |
|  | <b>LA9F103</b>    |                   |

(1) The time for which the coil of remote electrical reset device LA7-D03 can remain energised depends on its rest time: 1 s pulse with 9 s rest time; 5 s pulse duration with 30 s rest time; 10 s pulse duration with 90 s rest time: maximum pulse duration 20 s with rest time of 300 s. Minimum pulse time: 200 ms.

(2) Reference to be completed by adding the coil voltage code, see page 5/27



| Relay type             |                | Electronic overcurrent relays<br>TeSys LR97D |           |            |              |
|------------------------|----------------|--|-----------|------------|--------------|
| Relay setting range    |                | 0.3...1.5 A                                  | 1.2...7 A | 5...25 A   | 20...38 A    |
| For use with contactor |                | LC1D09...D38                                 |           |            | LC1D25...D38 |
| References             | 200... 240 VAC | LR97D015M7                                   | LR97D07M7 | LR97D025M7 | LR97D038M7   |
|                        | 100... 120 VAC | LR97D015F7                                   | LR97D07F7 | LR97D025F7 | LR97D038F7   |
|                        | 24 VAC/DC      | LR97D015B                                    | LR97D07B  | LR97D025B  | LR97D038B    |
|                        | 48 VAC/DC      | LR97D015E                                    | LR97D07E  | LR97D025E  | LR97D038E    |

**0.5...60 A**



| Relay type          |                | Electronic overcurrent relays<br>TeSys LT47 with manual reset |            |           |
|---------------------|----------------|---|------------|-----------|
| Relay setting range |                | 0.5...6 A   | 3...30 A   | 5...60 A  |
| References          | 200... 240 VAC | LT4706M7S   | LT47D30M7S | LT4760M7S |
|                     | 100... 120 VAC | LT47D06F7S  | LT47D30F7S | LT4760F7S |
|                     | 24 VAC/DC      | LT47D06BS   | LT47D30BS  | LT4760BS  |
|                     | 48 VAC/DC      | LT47D06ES   | LT47D30ES  | LT4760ES  |



| Relay type          |                | Electronic overcurrent relays<br>TeSys LT47 with automatic reset |            |           |
|---------------------|----------------|--|------------|-----------|
| Relay setting range |                | 0.5...6 A  | 3...30 A   | 5...60 A  |
| References          | 200... 240 VAC | LT4706M7A  | LT47D30M7A | LT4760M7A |
|                     | 100... 120 VAC | LT47D06F7A   | LT47D30F7A | LT4760F7A |
|                     | 24 VAC/DC      | LT47D06BA  | LT47D30BA  | LT4760BA  |
|                     | 48 VAC/DC      | LT47D06EA  | LT47D30EA  | LT4760EA  |

Accessories: please consult your Schneider Electric agency.



| Type of fieldbus |               |             | Ethernet   |               | Modbus     |               | Profibus DP |               |
|------------------|---------------|-------------|------------|---------------|------------|---------------|-------------|---------------|
| Supply voltage   |               |             | 24 VDC     | 100...240 VAC | 24 VDC     | 100...240 VAC | 24 VDC      | 100...240 VAC |
| References       | Current range | 0.4...8 A   | LTMR08EBD  | LTMR08EFM     | LTMR08MBD  | LTMR08MFM     | LTMR08PBD   | LTMR08PFM     |
|                  |               | 1.35...27 A | LTMR27EBD  | LTMR27EFM     | LTMR27MBD  | LTMR27MFM     | LTMR27PBD   | LTMR27PFM     |
|                  |               | 5...100 A   | LTMR100EBD | LTMR100EFM    | LTMR100MBD | LTMR100MFM    | LTMR100PBD  | LTMR100PFM    |



| Type of fieldbus |               |             | CANopen    |               | DeviceNet  |               |
|------------------|---------------|-------------|------------|---------------|------------|---------------|
| Supply voltage   |               |             | 24 VDC     | 100...240 VAC | 24 VDC     | 100...240 VAC |
| References       | Current range | 0.4...8 A   | LTMR08CBD  | LTMR08CFM     | LTMR08DBD  | LTMR08DFM     |
|                  |               | 1.35...27 A | LTMR27CBD  | LTMR27CFM     | LTMR27DBD  | LTMR27DFM     |
|                  |               | 5...100 A   | LTMR100CBD | LTMR100CFM    | LTMR100DBD | LTMR100DFM    |

## Extension module



| Type of module | Extension<br>4 additional inputs + voltage measuring |               | Ethernet external port<br>Modbus RTU / Modbus TCP/IP |
|----------------|--|---------------|--|
| Inputs voltage | 24 VDC   | 100...240 VAC | 24 VDC   |
| References     | LTMEV40BD  | LTMEV40FM     | TCSEQM113M13M  |

## Control unit



| Type of terminal | Compact display |
|------------------|-----------------|
| Supply voltage   | 24 VDC          |
| Reference        | LTMCU           |



| Type of transformer | External  |           |           |           |       |
|---------------------|-----------|-----------|-----------|-----------|-------|
| Operational current | primary   | 100 A     | 200 A     | 400 A     | 800 A |
|                     | secondary | 1 A       |           |           |       |
| References          | LT6CT1001 | LT6CT2001 | LT6CT4001 | LT6CT8001 |       |

### Earth fault toroids

| Type of toroid    | Closed |      |       |       |       |       | Split |       |
|-------------------|--------|------|-------|-------|-------|-------|-------|-------|
| Maximum current   | 65 A   | 85 A | 160 A | 250 A | 400 A | 630 A | 85 A  | 250 A |
| Internal diameter | Ø 30   | Ø 50 | Ø 80  | Ø 120 | Ø 200 | Ø 300 | Ø 46  | Ø 110 |
| References        | TA30   | PA50 | IA80  | MA120 | SA200 | GA300 | POA   | GOA   |

4

### PTC thermistor probe

| Type of probe         | Triple   |          |          |          |          |          |          |          |
|-----------------------|----------|----------|----------|----------|----------|----------|----------|----------|
| Operating temperature | 90°C     | 110°C    | 120°C    | 130°C    | 140°C    | 150°C    | 160°C    | 170°C    |
| References            | DA1TT090 | DA1TT110 | DA1TT120 | DA1TT130 | DA1TT140 | DA1TT150 | DA1TT160 | DA1TT170 |

### Accessories (1)



| Type of accessory | Connecting cable<br>Controller / Extension module |        |        |
|-------------------|---|--------|--------|
| Length of cable   | 0.04 m  | 0.3 m  | 1 m    |
| References        | LTMCC004  | LU9R03 | LU9R10 |



| Type of accessory | Connecting cable<br>Controller/ Display |             |             | Connection kit<br>PC serial port |
|-------------------|---|-------------|-------------|----------------------------------|
| Length of cable   | 1 m                                     | 3 m         | 5 m         | –                                |
| References        | VW3A1104R10                             | VW3A1104R30 | VW3A1104R50 | VW3A8106                         |

(1) For other connection accessories, see [www.schneider-electric.com](http://www.schneider-electric.com)



| Relay type                       | PTC thermistor probes |                |
|----------------------------------|-----------------------|----------------|
| For use with contactor           | LC1-D or LC1-F        | LC1-D or LC1-F |
| Motor current                    | No limit              | 1...5 A        |
| Basic reference, to be completed | LT3S                  | LT6P0M0•5FM    |

## Protection unit

4

| Type   | with automatic reset with thermistor short-circuit detection |                |           |           |
|--|--|----------------|-----------|-----------|
| <b>without fault memory</b>  |  |                |           |           |
| Connection   | Voltage  | Output contact | Reference |           |
| by cage connectors   | ~ 50/60 Hz   | 115 V          | NC        | LT3SE00F  |
|  |  | 230 V          | NC        | LT3SE00M  |
|  | ---  | 24 V           | NC        | LT3SE00F  |
| <b>On front panel: fault and voltage signalling indicator</b>                        |  |                |           |           |
|  | ~ 50/60 Hz   | 115/230 V      | NC + NO   | LT3SA00M  |
|  | ---  | 24/48 V        | NC + NO   | LT3SA00ED |
|  | ~ 50/60 Hz or ---  | 24...230 V     | 2 CO      | LT3SA00MW |
| <b>with fault memory</b>   |  |                |           |           |
| <b>On front panel: fault and voltage signalling indicator, Test and Reset button</b> |  |                |           |           |
|  | ~ 50/60 Hz   | 400 V          | NC + NO   | LT3SM00V  |
|  |  | 24/48 V        | NC + NO   | LT3SM00E  |
|  |  | 115/230 V      | NC + NO   | LT3SM00M  |
|  | ---  | 24/48 V        | NC + NO   | LT3SM00ED |
|  | ~ 50/60 Hz or ---  | 24...230 V     | 2 CO      | LT3SM00MW |

## Accessories

| Type                               | PTC thermistor probes for LT3 relays |          |          |          |          |          |          |          |
|------------------------------------|--------------------------------------|----------|----------|----------|----------|----------|----------|----------|
| Normal operating temperature (NOT) | 90 °C                                | 110 °C   | 120 °C   | 130 °C   | 140 °C   | 150 °C   | 160 °C   | 170 °C   |
| <b>Integrated triple probes</b>    | DA1TT090                             | DA1TT110 | DA1TT120 | DA1TT130 | DA1TT140 | DA1TT150 | DA1TT160 | DA1TT170 |
| Normal operating temperature (NOT) | 60 °C                                | 70 °C    | 80 °C    | 90 °C    | 100 °C   |          |          |          |
| <b>Surface probes</b>              | DA1TS060                             | DA1TS070 | DA1TS080 | DA1TS090 | DA1TS100 |          |          |          |



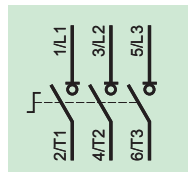

| Type                              | Mini-Vario for standard applications |               |                                 |
|-----------------------------------|--------------------------------------|---------------|---------------------------------|
|                                   | Door mounting                        |               | Backplate mounting in enclosure |
| Colour: Handle / Front plate      | Red / Yellow                         | Black / Black | Red / Yellow                    |
| Front plate dimensions (mm)       | 60 x 60                              |               | 60 x 60                         |
| Fixing                            | Ø 22.5 mm                            |               | Ø 22.5 mm                       |
| Degree of protection              | IP 20                                |               | IP 20                           |
| Rated insulation voltage (Ui)     | 690 V                                |               | 690 V                           |
| Thermal current in open air (Ith) | 12 A                                 | VCDN12        | VBDN12                          |
|                                   | 20 A                                 | VCDN20        | VBDN20                          |

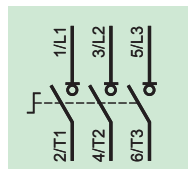

4

| Type                              | Vario for high performance applications |               |              |               |                                 |              |          |        |       |
|-----------------------------------|---|---------------|--------------|---------------|---------------------------------|--------------|----------|--------|-------|
|                                   | Door mounting                           |               |              |               | Backplate mounting in enclosure |              |          |        |       |
| Colour: Handle / Front plate      | Red / Yellow                            | Black / Black | Red / Yellow | Black / Black | Red / Yellow                    | Red / Yellow |          |        |       |
| Front plate dimensions (mm)       | 60 x 60                                 |               | 60 x 60      |               | 90 x 90                         | 60 x 60      | 90 x 90  |        |       |
| Fixing                            | Ø 22.5 mm                               |               | 4 screws     |               | 4 screws                        | Ø 22.5 mm    | 4 screws |        |       |
| Degree of protection              | IP 20                                   |               | IP 20        |               | IP 20                           | IP 20        | IP 20    |        |       |
| Rated insulation voltage (Ui)     | 690 V                                   |               | 690 V        |               | 690 V                           | 690 V        | 690 V    |        |       |
| Thermal current in open air (Ith) | 12 A                                    | VCD02         | VBD02        | VCF02         | VBF02                           | –            | VCCD02   | VCCF02 | –     |
|                                   | 20 A                                    | VCD01         | VBD01        | VCF01         | VBF01                           | –            | VCCD01   | VCCF01 | –     |
|                                   | 25 A                                    | VCD0          | VBD0         | VCF0          | VBF0                            | –            | VCCD0    | VCCF0  | –     |
|                                   | 32 A                                    | VCD1          | VBD1         | VCF1          | VBF1                            | –            | VCCD1    | VCCF1  | –     |
|                                   | 40 A                                    | VCD2          | VBD2         | VCF2          | VBF2                            | –            | VCCD2    | VCCF2  | –     |
|                                   | 63 A                                    | –             | –            | VCF3          | VBF3                            | –            | –        | VCCF3  | –     |
|                                   | 80 A                                    | –             | –            | VCF4          | VBF4                            | –            | –        | VCCF4  | –     |
|                                   | 125 A                                   | –             | –            | –             | –                               | VCF5         | –        | –      | VCCF5 |
| 175 A                             | –                                       | –             | –            | –             | VCF6                            | –            | –        | VCCF6  |       |



| Add-on modules   | For mini-Vario |       | For Vario |      |             |         |               |      |      |
|--|----------------|-------|-----------|------|-------------|---------|---------------|------|------|
| <b>Main pole modules</b>   |                |       |           |      |             |         |               |      |      |
| Switch rating  | 12 A           | 20 A  | 12 A      | 20 A | 25 A        | 32 A    | 40 A          | 63 A | 80 A |
| References   | VZN12          | VZN20 | VZ02      | VZ01 | VZ0         | VZ1     | VZ2           | VZ3  | VZ4  |
| <b>Neutral pole module with early make and late break contacts</b> |                |       |           |      |             |         |               |      |      |
| Switch rating  | 12...20 A      |       | 12...40 A |      | 63 and 80 A |         | 125 and 175 A |      |      |
| References   | VZN11          |       | VZ11      |      | VZ12        |         | VZ13          |      |      |
| <b>Earthing module</b>   |                |       |           |      |             |         |               |      |      |
| Switch rating  | 12...20 A      |       | 12...40 A |      | 63 and 80 A |         | 125 and 175 A |      |      |
| References   | VZN14          |       | VZ14      |      | VZ15        |         | VZ16          |      |      |
| <b>Auxiliary contact block modules</b>                             |                |       |           |      |             |         |               |      |      |
| Contact type   | NO             | NC    | NO + NC   |      |             | NO + NO |               |      |      |
| References   | VZN05          | VZN06 | VZ7       |      |             | VZ20    |               |      |      |



**D.O.L. starters**

|   |               | with circuit-breaker   |              | with fuse protection                   |
|---|---------------|--|--------------|--|
| Level of service                        | Coordination: | Type 1   |              | Type 2                                 |
| Power at 400 V                          | Up to:        | 5.5 kW   | 15 kW        | 37 kW                                  |
| Type of components                      |               | Combination automatic motor starter with overload protection incorporated in the circuit-breaker |              | Fuse carrier + plate-mounted contactor |
| <b>Basic reference, to be completed</b> |               | <b>GV2ME</b>   | <b>GV2DM</b> | <b>GV2DP</b>                           |

4



**Starters GV2-ME**

| Standard power ratings of 3-phase motors 50/60 Hz in category AC-3 (kW) |       |       | Setting range of thermal trips | Fixed magnetic tripping current | For customer assembly |            | Non-reversing     | Reversing   |
|---|-------|-------|--------------------------------|---------------------------------|-----------------------|------------|-------------------|---|
| 400/415 V   | 440 V | 500 V |                                |                                 | Motor circuit-breaker | Contactors | Factory assembled | Basic reference, to be completed with code indicating control circuit voltage |
| 0.37  | 0.37  | 0.37  | 1...1.6                        | 22.5                            | GV2ME06               | LC1K06     | GV2ME06K1**       | GV2ME06K2**   |
| 0.55  | 0.55  | 0.55  |                                |                                 |                       |            |                   |   |
| -   | -     | 0.75  |                                |                                 |                       |            |                   |   |
| 0.75  | 0.75  | -     | 1.6...2.5                      | 33.5                            | GV2ME07               | LC1K06     | GV2ME07K1**       | GV2ME07K2**   |
| -   | 1.1   | 1.1   |                                |                                 |                       |            |                   |   |
| 1.1   | -     | 1.5   | 2.5...4                        | 51                              | GV2ME08               | LC1K06     | GV2ME08K1**       | GV2ME08K2**   |
| 1.5   | 1.5   | 2.2   |                                |                                 |                       |            |                   |   |
| 2.2   | 2.2   | -     | 4...6.3                        | 78                              | GV2ME10               | LC1K06     | GV2ME10K1**       | GV2ME10K2**   |
| -   | -     | 3     |                                |                                 |                       |            |                   |   |
| 3   | -     | 4     | 6...10                         | 138                             | GV2ME14               | LC1K09     | GV2ME14K1**       | GV2ME14K2**   |
| 4   | 4     | 5.5   |                                |                                 |                       |            |                   |   |
| 5.5   | 5.5   | 7.5   | 9...14                         | 170                             | GV2ME16               | LC1K12     | GV2ME16K1**       | GV2ME16K2**   |

**Standard control circuit voltages** (for other voltages, please consult your Regional Sales Office)

| Volts         | 24         | 110       | 220/230   | 230       | 230/240   | 380/400   |
|---------------|------------|-----------|-----------|-----------|-----------|-----------|
| ~ 50...400 Hz | <b>B7</b>  | <b>F7</b> | <b>M7</b> | <b>P7</b> | <b>U7</b> | <b>Q7</b> |
| --- (1)       | <b>BW3</b> | -         | -         | -         | -         | -         |

(1) Low consumption coil (1.5 W), wide range (0.7...1.3 Uc) and with integral suppression device as standard.



### D.O.L. starters GV2DM and GV3-DP

| Standard power ratings of 3-phase motors 50/60 Hz in category AC-3 (kW) |       |       |             | Setting range of thermal trips | Fixed magnetic tripping current | For customer assembly |           | Non-reversing     | Reversing   |
|---|-------|-------|-------------|--------------------------------|---------------------------------|-----------------------|-----------|-------------------|---|
| 400/415 V   | 440 V | 500 V |             |                                |                                 | Motor circuit-breaker | Contactor | Factory assembled |   |
|   |       |       |             |                                |                                 |                       |           |                   | Basic reference, to be completed with code indicating control circuit voltage |
| 0.06  | 0.06  | -     | 0.16...0.25 | 2.4                            | 13 Irth                         | GV2ME02               | LC1D09**  | GV2DM102**        | GV2DM202**  |
|   |       |       |             |                                |                                 | GV2P02                | LC1D09**  | GV2DP102**        | GV2DP202**  |
| 0.09  | 0.09  | -     | 0.25...0.40 | 5                              |                                 | GV2ME03               | LC1D09**  | GV2DM103**        | GV2DM203**  |
| -   | 0.12  | -     |             |                                |                                 | GV2P03                | LC1D09**  | GV2DP103**        | GV2DP203**  |
| 0.12  | -     | -     | 0.40...0.63 | 8                              |                                 | GV2ME04               | LC1D09**  | GV2DM104**        | GV2DM204**  |
| 0.18  | 0.18  | -     |             |                                |                                 | GV2P04                | LC1D09**  | GV2DP104**        | GV2DP204**  |
| 0.25  | 0.25  | -     | 0.63...1    | 13                             |                                 | GV2ME05               | LC1D09**  | GV2DM105**        | GV2DM205**  |
| 0.37  | 0.37  | -     |             |                                |                                 | GV2P05                | LC1D09**  | GV2DP105**        | GV2DP205**  |
| -   | -     | 0.37  | 1...1.6     | 22.5                           |                                 | GV2ME06               | LC1D09**  | GV2DM106**        | GV2DM206**  |
| 0.55  | 0.55  | 0.55  |             |                                |                                 | GV2P06                | LC1D09**  | GV2DP106**        | GV2DP206**  |
| -   | -     | 0.75  |             |                                |                                 |                       |           |                   |   |
| 0.75  | 0.75  | -     | 1.6...2.5   | 33.5                           |                                 | GV2ME07               | LC1D09**  | GV2DM107**        | GV2DM207**  |
| -   | 1.1   | 1.1   |             |                                |                                 | GV2P07                | LC1D09**  | GV2DP107**        | GV2DP207**  |
| 1.1   | -     | 1.5   | 2.5...4     | 51                             |                                 | GV2ME08               | LC1D09**  | GV2DM108**        | GV2DM208**  |
| 1.5   | 1.5   | 2.2   |             |                                |                                 | GV2P08                | LC1D09**  | GV2DP108**        | GV2DP208**  |
| 2.2   | 2.2   | -     | 4...6.3     | 78                             |                                 | GV2ME10               | LC1D09**  | GV2DM110**        | GV2DM210**  |
| -   | 3     | 3     |             |                                |                                 | GV2P10                | LC1D09**  | GV2DP110**        | GV2DP210**  |
| 3   | -     | 4     | 6...10      | 138                            |                                 | GV2ME14               | LC1D09**  | GV2DM114**        | GV2DM214**  |
| 4   | 4     | 5.5   |             |                                |                                 | GV2P14                | LC1D09**  | GV2DP114**        | GV2DP214**  |
| 5.5   | 5.5   | 7.5   | 9...14      | 170                            |                                 | GV2ME16               | LC1D12**  | GV2DM116**        | GV2DM216**  |
| -   | 7.5   | 9     |             |                                |                                 | GV2P16                | LC1D25**  | GV2DP116**        | GV2DP216**  |
| 7.5   | 9     | -     | 13...18     | 223                            |                                 | GV2ME20               | LC1D18**  | GV2DM120**        | GV2DM220**  |
|   |       |       |             |                                |                                 | GV2P20                | LC1D25**  | GV2DP120**        | GV2DP220**  |
| 9   | 11    | 11    | 17...23     | 327                            |                                 | GV2ME21               | LC1D25**  | GV2DM121**        | GV2DM221**  |
|   |       |       |             |                                |                                 | GV2P21                | LC1D25**  | GV2DP121**        | GV2DP221**  |
| 11  | -     | 15    | 20...25     | 327                            |                                 | GV2ME22               | LC1D25**  | GV2DM122**        | GV2DM222**  |
|   |       |       |             |                                |                                 | GV2P22                | LC1D25**  | GV2DP122**        | GV2DP222**  |
| 15  | 15    | 18.5  | 24...32     | 416                            |                                 | GV2ME32               | LC1D32**  | GV2DM132**        | GV2DM232**  |
|   |       |       |             |                                |                                 | GV2P32                | LC1D32**  | GV2DP132**        | GV2DP232**  |

4

### D.O.L. starters GV3 + LC1D

| Standard power ratings of 3-phase motors 50/60 Hz in category AC-3 (kW) |       |       |         | Setting range of thermal trips | Fixed magnetic tripping current | For customer assembly |           | Non-reversing  | Reversing |
|---|-------|-------|---------|--------------------------------|---------------------------------|-----------------------|-----------|--|-----------|
| 400/415 V   | 440 V | 500 V |         |                                |                                 | Motor circuit-breaker | Contactor | Reference of accessory to be ordered for assembly of motor starter (2) |           |
| 18,5  | 18,5  | -     | 30...40 | 560                            |                                 | GV3P401 (1)           | LC1D40A** | -  | LAD9R3    |
| -   | 22    | 22    | 30...40 | 560                            |                                 | GV3P401 (1)           | LC1D40A** | -  | LAD9R3    |
| 22  | -     | 30    | 37...50 | 700                            |                                 | GV3P501 (1)           | LC1D50A** | -  | LAD9R3    |
| 30  | 30    | 37    | 48...65 | 910                            |                                 | GV3P651 (1)           | LC1D65A** | -  | LAD9R3    |

(1) Circuit-breaker GV3P without downstream EverLink terminal block. A standard GV3P can also be used by removing the downstream terminal block.

(2) For side by side circuit-breaker/contacting mounting, order accessory GV3S.

#### Standard control circuit voltages (for other voltages, please consult your Regional Sales Office)

|               |           |           |           |
|---------------|-----------|-----------|-----------|
| Volts         | 24        | 220       | 230       |
| ~ 50...400 Hz | <b>B7</b> | <b>M7</b> | <b>P7</b> |
| ⋮ (3)         | <b>BD</b> | -         | -         |

(3) Low consumption coil, wide range (0.7 to 1.25 Uc) and with suppression device as standard (bidirectional peak limiting diode).



| Function characteristics, LUB... + LUCA...  | Maximum motor power < 400/415 V | Power base    |               | Standard control unit |               |
|---|---------------------------------|---------------|---------------|-----------------------|---------------|
|   |                                 | Non-reversing | Reversing (1) | Class 10 (2)          | Setting range |
| - Thermal overload protection against: short-circuit, overcurrent, phase failure or imbalance, insulation breaks (equipment only).<br>- Manual reset following thermal fault. | 0.09 kW                         | LUB12         | LU2B12●●      | LUCA6X●●              | 0.15...0.6 A  |
|   | 0.25 kW                         | LUB12         | LU2B12●●      | LUCA1X●●              | 0.35...1.4 A  |
|   | 1.5 kW                          | LUB12         | LU2B12●●      | LUCA05●●              | 1.25...5 A    |
|   | 5.5 kW                          | LUB12         | LU2B12●●      | LUCA12●●              | 3...12 A      |
|   | 7.5 kW                          | LUB32         | LU2B32●●      | LUCA18●●              | 4.5...18 A    |
| 15 kW   | LUB32                           | LU2B32●●      | LUCA32●●      | 8...32 A              |               |

## ADVANCED motor starter



| Function characteristics, LUB... + LUCA...   | Maximum motor power < 400/415 V | Power base Non-reversing | Advanced control unit |              | Setting range |
|--|---------------------------------|--------------------------|-----------------------|--------------|---------------|
|  |                                 |                          | Class 10 (2) (3)      | Class 20 (2) |               |
| - Thermal overload protection against: short-circuit, overcurrent, phase failure or imbalance, insulation breaks (equipment only).<br>- Manual reset following thermal fault.<br>- Thermal overload test function. | 0.09 kW                         | LUB120                   | LUCB6X●●              | LUCD6X●●     | 0.15...0.6 A  |
|  | 0.25 kW                         | LUB120                   | LUCB1X●●              | LUCD1X●●     | 0.35...1.4 A  |
|  | 1.5 kW                          | LUB120                   | LUCB05●●              | LUCD05●●     | 1.25...5 A    |
|  | 5.5 kW                          | LUB120                   | LUCB12●●              | LUCD12●●     | 3...12 A      |
|  | 7.5 kW                          | LUB320                   | LUCB18●●              | LUCD18●●     | 4.5...18 A    |
| 15 kW  | LUB320                          | LUCB32●●                 | LUCD32●●              | 8...32 A     |               |

(3) For single-phase-motors, replace LUCB●●●● by LUC●●●●.

## MULTIFUNCTION motor starter



| Function characteristics, LUB... + LUCA...   | Maximum motor power < 400/415 V | Power base Non-reversing | Multifunction control unit |               |
|--|---------------------------------|--------------------------|----------------------------|---------------|
|  |                                 |                          | Class 5 to 30              | Setting range |
| - Thermal overload protection against: short-circuit, overcurrent, phase failure or imbalance, insulation breaks (equipment only).<br>- Manual, automatic or remote reset,<br>- Thermal overload test function,<br>- Overtorque and no-load running, alarm,<br>- Motor operation log,<br>- Motor parameters display on LUCM..., PC or HMI,<br>- Integrated Modbus communication. | 0.09 kW                         | LUB120                   | LUCM6XBL                   | 0.15...0.6 A  |
|  | 0.25 kW                         | LUB120                   | LUCM1XBL                   | 0.35...1.4 A  |
|  | 1.5 kW                          | LUB120                   | LUCM05BL                   | 1.25...5 A    |
|  | 5.5 kW                          | LUB120                   | LUCM12BL                   | 3...12 A      |
|  | 7.5 kW                          | LUB320                   | LUCM18BL                   | 4.5...18 A    |
| 15 kW  | LUB320                          | LUCM32BL                 | 8...32 A                   |               |

(1) Complete the references of the power bases according to the following table.

Example: LU2B12

●●

(2) Complete the references of the control units according to the following table.

Example: LUCA/B/D/M6X

●●

### Standard control circuit voltages

|                                 |    |
|---------------------------------|----|
| 24 V DC                         | BL |
| 24 V AC                         | B  |
| 48 V AC / 48...72 V DC          | ES |
| 110...240 V AC / 110...220 V DC | FU |



| Type of optional function  | Thermal overload alarm | Thermal fault signalling |                     |         | Motor load indication |
|----------------------------|------------------------|--------------------------|---------------------|---------|-----------------------|
| Compatible with LUCA       | NO                     | NO                       | NO                  | NO      | NO                    |
| Compatible with LUCL       | NO                     | NO                       | NO                  | NO      | NO                    |
| Compatible with LUCB, LUCD | YES                    | YES                      | YES                 | YES     | YES                   |
| Compatible with LUCM       | NO                     | NO                       | NO                  | NO      | YES                   |
| Output signal              | 1 NO                   | 1 NO +1 NC               | 1 NC                | 1 NO    | 4...20 mA             |
| Reset                      | NA                     | Manual                   | Automatic or remote |         | NA                    |
| References                 | LUFW10                 | LUFDA01                  | LUFDA10             | LUFDA10 | LUFV2                 |

### Communication modules



| Type of communication  | Modbus               | Modicon STB                      | Profibus DP                | CANopen                | DeviceNet               | AS-Interface               | Parallel wiring            |
|--|----------------------|----------------------------------|----------------------------|------------------------|-------------------------|----------------------------|----------------------------|
| Only compatible with 24 V DC control units<br>LUCA..BL, LUCB..BL, LUCD..BL, LUCM..BL | YES                  | YES                              | YES                        | YES                    | YES                     | YES                        | YES                        |
| Transfer speed   | 19.2 Kbps            | Dpg. on NIM (1)                  | 9.6...12 Mbps              | 20 K...1 Mbps          | 125...500 Kbaud         | 167 Kbps                   | NA                         |
| Number of slaves   | 31 per Modbus master | Dpg. on Network Interface Module | 125 per Profibus DP module | 128 per CANopen module | 63 per DeviceNet module | 62 per AS-Interface master | 8 per LU9GC02 splitter box |
| Pre-wired coil connection (A1 A2)  | LU9BN11C, LU9MRC     | LU9BN11L, LU9MRL                 | LU9BN11L, LU9MRL           | LU9BN11L, LU9MRL       | LU9BN11L, LU9MRL        | LU9BN11C, LU9MRC           | LU9Rxx                     |
| Connecting cable to PC   | VW3 A8 306 R●●       | LU9RCD●●, LU9RDD●●               | TSXPBSCA●●                 | TSXCANC●●              | DeviceNet standard      | XZCG0142                   | TSXCDP●●●                  |
| References   | L UFC033             | LULC15                           | LULC07                     | LULC08                 | LULC09                  | ASILUFC51                  | L UFC00                    |

(1) Network Interface Module.

### Information carried by the Modbus, Modicon STB or CANopen bus

| Type of control unit                                   | LUCA●●BL | LUCB●●BL, LUCD●●BL | LUCM●●BL |
|--|----------|--------------------|----------|
| Start and Stop commands                                | X        | X                  | X        |
| Starter status (ready, running, fault)                 | X        | X                  | X        |
| Thermal alarm  |          | X                  | X        |
| Remote reset via the bus                               |          | X                  | X        |
| Indication of motor load                               |          | X                  | X        |
| Signalling and fault differentiation                   |          | X                  | X        |
| Alarms (overcurrent, ...)                              |          |                    | X        |
| Remote programming and monitoring of all the functions |          |                    | X        |
| "Log" function   |          |                    | X        |
| Monitoring function                                    |          |                    | X        |

### Contact blocks



| Type of contact block       | Add-on                     | Auxiliary  |            |            |            |            |
|-----------------------------|----------------------------|------------|------------|------------|------------|------------|
| Signalling contacts         | of any fault               | NC (95-96) | NO (97-98) | –          | –          | –          |
|                             | position of control handle | NO (17-18) | NO (17-18) | –          | –          | –          |
| 2 auxiliary contacts module |                            | –          | –          | NO (33-34) | NC (31-32) | NC (31-32) |
|                             |                            | –          | –          | NO (43-44) | NO (43-44) | NC (41-42) |
| References                  | Screw clamp terminals      | LUA1C11    | LUA1C20    | LUFN20     | LUFN11     | LUFN02     |
|                             | Without connections        | LUA1C110   | LUA1C200   | –          | –          | –          |

# TeSys

## LUTM

TeSys GV3L  
Circuit-breakers

TeSys LC1D  
Contactor

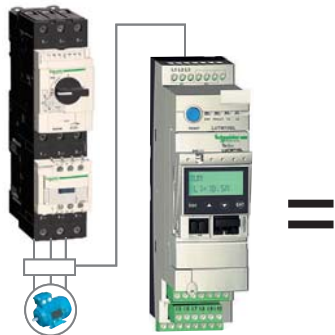

## Controller for 3-phase motors MULTIFUNCTION protection



+



| Function characteristics   | Control base for use with contactors |                  | Multifunction control unit |
|--|--------------------------------------|------------------|----------------------------|
|  | TeSys D (LC1D..)                     | TeSys F (LC1F..) | Class 5 to 35              |
| <ul style="list-style-type: none"> <li>- Thermal overload protection against: short-circuit, overcurrent, phase failure or imbalance, insulation breaks (equipment only).</li> <li>- Manual, automatic or remote reset,</li> <li>- Thermal overload test function,</li> <li>- Overtorque and no-load running, alarm,</li> <li>- Motor operation log,</li> <li>- Motor parameters display on LUCM..., PC or HMI,</li> <li>- Integrated Modbus communication.</li> </ul> | LUTM10BL                             | LUTM20BL         | LUCMT1BL                   |

## ADVANCED protection



| Function characteristics   | Control base for use with contactors |                  | Advanced control unit |          |
|--|--------------------------------------|------------------|-----------------------|----------|
|  | TeSys D (LC1D..)                     | TeSys F (LC1F..) | Class 10              | Class 20 |
| <ul style="list-style-type: none"> <li>- Thermal overload protection against: short-circuit, overcurrent, phase failure or imbalance, insulation breaks (equipment only).</li> <li>- Manual reset following thermal fault.</li> <li>- Thermal overload test function.</li> </ul> | LUTM10BL                             | LUTM20BL         | LUCBT1BL              | LUCDT1BL |

## Current transformers

| Type of transformer |           |          |          |           |           |           |           |
|---------------------|-----------|----------|----------|-----------|-----------|-----------|-----------|
| Supply voltage      |           | 24 V DC  |          |           |           |           |           |
| Operating current   | Primary   | 30 A     | 50 A     | 100 A     | 200 A     | 400 A     | 800 A     |
|                     | Secondary | 1 A      |          |           |           |           |           |
| References          |           | LUTC0301 | LUTC0501 | LUTC01001 | LUTC02001 | LUTC04001 | LUTC05001 |

Above 32 A, the TeSys U controller provides a motor starter management system solution identical to that provided by the **TeSys U** starter-controller.

Used in conjunction with a short-circuit protection device and a contactor, it provides a motor starter whose functions are the same as those of a **TeSys U** starter-controller and, in particular, provides the following functions: overload protection, motor starter control and application monitoring.

It comprises a control unit, whose adjustment range is compatible with the secondary of current transformers, and a control base that also enables the fitting of a function module or communication module.

It requires a 24 V DC external power supply.



| Type of optional function  | Thermal overload alarm | Motor load indication |
|----------------------------|------------------------|-----------------------|
| Compatible with LUCA       | NO                     | NO                    |
| Compatible with LUCL       | NO                     | NO                    |
| Compatible with LUCB, LUCD | YES                    | YES                   |
| Compatible with LUCM       | NO                     | YES                   |
| Output signal              | 1 NO                   | 4...20 mA             |
| Reset                      | NA                     | NA                    |
| References                 | LUFW10                 | LUFV2                 |



| TeSys rotating handles for           | TeSys U  |
|--------------------------------------|----------|
| Kit IP54 black handle                | LU9APN21 |
| IP54 kit red handle and yellow front | LU9APN22 |
| IP65 kit red handle and yellow front | LU9APN24 |

## Communication modules



| Type of communication  | Modbus                     | Modicon STB                      | CANopen                | DeviceNet               | Parallel wiring            |
|--|----------------------------|----------------------------------|------------------------|-------------------------|----------------------------|
| Only compatible with 24 V DC control units<br>LUCA..BL, LUCB..BL, LUCD..BL, LUCM..BL | YES                        | YES                              | YES                    | YES                     | YES                        |
| Transfer speed   | 19.2 Kbps                  | Dpg. on NIM (1)                  | 20 K...1 Mbps          | 125...500 Kbaud         | NA                         |
| Number of slaves   | 31 per Modbus master       | Dpg. on Network Interface Module | 128 per CANopen module | 63 per DeviceNet module | 8 per LU9GC02 splitter box |
| Pre-wired coil connection (A1 A2)  | LU9BN11C, LU9MRC           | LU9BN11L, LU9MRL                 | LU9BN11L, LU9MRL       | LU9BN11L, LU9MRL        | LU9Rxx                     |
| Connecting cable to PC   | VW3 A8 306 R●●<br>LU9RDD●● | LU9RCD●●                         | TSXCANC●●              | DeviceNet standard      | TSXCDP●●●                  |
| References   | LUFC033                    | LULC15                           | LULC08                 | LULC09                  | LUFC00                     |

| Information carried by the Modbus, Modicon STB or CANopen bus |                    |          |
|---|--------------------|----------|
| Type of control unit  | LUCBT1BL, LUCDT1BL | LUCMT1BL |
| Start and Stop commands                                       | X                  | X        |
| Starter status (ready, running, fault)                        | X                  | X        |
| Thermal alarm   | X                  | X        |
| Remote reset via the bus                                      | X                  | X        |
| Indication of motor load                                      | X                  | X        |
| Signalling and fault differentiation                          | X                  | X        |
| Alarms (overcurrent, ...)                                     |                    | X        |
| Remote programming and monitoring of all the functions        |                    | X        |
| "Log" function  |                    | X        |
| Monitoring function   |                    | X        |



### Starters

#### D.O.L.

##### ■ standard

| Standard power ratings of 3-phase motors in category AC3 400/415 V |                          | 4...37 kW | 0.06...37 kW | 0.55...30 kW | 0.37...5.5 kW | 0.25...45 kW |
|--|--------------------------|-----------|--------------|--------------|---------------|--------------|
| Starters   | manual                   | ●         | ●            | ●            | -             | -            |
|  | auto                     | -         | -            | -            | ●             | ●            |
| Isolating device   | switch-disconnector-fuse | ●         | -            | -            | -             | -            |
|  | circuit-breaker          | -         | ●            | ●            | ●             | -            |
|  | fuse carrier             | -         | -            | -            | -             | -            |
| Protection   | short-circuit            | -         | ●            | ●            | ●             | -            |
|  | overload                 | -         | ●            | -            | ●             | ●            |
| Communication  |                          | -         | -            | -            | -             | -            |
| Basic reference  | Non-reversing            | V•F•GE    | GV2ME        | GV2LC        | LE1GVME       | LE1M         |
|  |                          | VCFN•GE   | GV3PC        | GV-NGC       |               | LE1D         |
|  |                          | V•FXGE•   | GV3CE        |              |               |              |
|  | Reversing                |           |              |              |               | LE2K         |
|  |                          |           |              |              |               | LE2D         |





2 stage

|      | ■ safety applications |              |             | ■ AS-Interface bus |               | standard star-delta |             |
|------|-----------------------|--------------|-------------|--------------------|---------------|---------------------|-------------|
|      | 2.2...45 kW           | 0.06...11 kW | 0.06...9 kW | 0.06...9 kW        | 0.06...5.5 kW | 5.5...132 kW        | 7.5...75 kW |
|      | -                     | ●            | -           | -                  | -             | -                   | -           |
|      | ●                     | -            | ●           | ●                  | ●             | ●                   | ●           |
|      | -                     | -            | ●           | -                  | -             | -                   | -           |
|      | -                     | ●            | ●           | ●                  | ●             | -                   | -           |
|      | ●                     | -            | -           | -                  | -             | -                   | ●           |
|      | ●                     | ●            | ●           | ●                  | ●             | -                   | ●           |
|      | ●                     | ●            | ●           | ●                  | ●             | ●                   | ●           |
|      | -                     | -            | -           | -                  | ●             | -                   | -           |
| LE4K |                       | GV2ME        | LG1K        | LG7K               | LF3M          | LE3K                | LE6D        |
| LE4D |                       |              | LG1D        | LG7D               | LF3P          | LE3D                | LE3D        |
|      |                       |              |             | LJ7K               | LF7P          | LE3F                |             |
| LE8K |                       |              |             | LG8K               | LF4M          |                     |             |
| LE8D |                       |              |             | LJ8K               | LF4P          |                     |             |
| LE2D |                       |              |             |                    | LF8P          |                     |             |

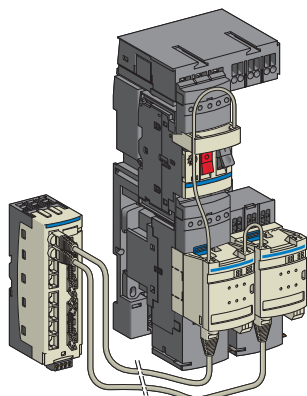

TeSys Quickfit is a modular system which standardises and simplifies the implementation of motor starters with its pre-wired control and power circuits.

Installation of a motor starter becomes quick, simple, safe and flexible.

In addition, this system:

- enables the motor starter to be customised at a later date,
- reduces maintenance time and
- optimises panel space by reducing the number of terminals and intermediate interfaces and the amount of ducting.

The motor starters concerned are those created by combining:

- GV2 ME or GV3 P circuit-breakers, with an operating limit of 80% of the maximum current at an ambient temperature of 60 °C, up to 690 V
- with 9 to 65 A TeSys D (LC1) contactors.

This offer comprises components for pre-wiring

- the power part,
- the control part.

### Components for pre-wiring the power part

- a **power kit** comprising, for each starter, a plate for mounting the contactor and the circuit-breaker, and two power connection modules,
- a **power splitter box** for 2 or 4 starters,
- an **upstream terminal block** for a power supply up to 60 A (16 mm<sup>2</sup>),
- a **downstream terminal block** for connecting the motor power supply cables and the earth cables (6 mm<sup>2</sup>).

### Components for pre-wiring the control part

- a **control circuit connection module** that mounts directly on the contactor and the circuit-breaker of each starter. This module integrates the status and control information of this particular motor starter.
- a **parallel wiring module** enabling grouping of the information relating to each motor starter:
  - **HE 10**, intended for centralised applications. The information is transmitted to the PLC via the Modicon pre-wired system.
  - **STB**, intended for decentralised automation architectures. This module is integrated in an Modicon STB configuration for connection to the PLC via a fieldbus.

## 9...25 A power pre-wiring components

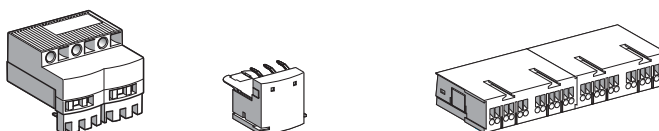

| Type                         | Terminal block<br>Upstream | Downstream        | 60 A power splitter box<br>Extension by LAD32● |        |
|------------------------------|----------------------------|-------------------|--|--------|
| Maximum c.s.a. of connection | 16 mm <sup>2</sup>         | 6 mm <sup>2</sup> | –  | –      |
| Use                          | Splitter boxes supply      | Motor cables      | –  | –      |
| Number of starters           | –                          | –                 | 2  | 4      |
| Reference                    | LAD3B1                     | LAD331            | LAD322   | LAD324 |

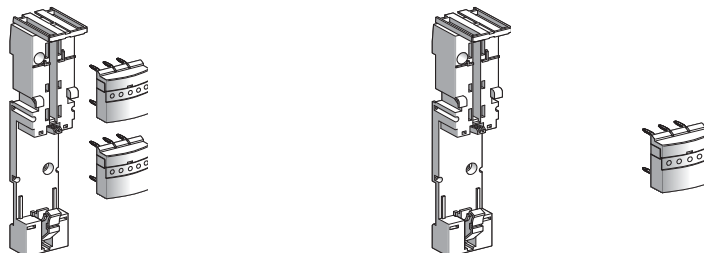

| Type        | Connection kit<br>For D.O.L. starter (1)                               | Mounting plate for<br>GV2 ME & contactor | Power connection<br>module |
|-------------|--|--|----------------------------|
| Composition | 1 mounting plate LAD311 for GV2ME<br>2 power connection modules LAD341 | For 1 motor starter                      |                            |
| Reference   | LAD252   | LAD311                                   | LAD341                     |

(1) For a reversing starter order 2 connection kits LAD252

## Control-command pre-wiring components

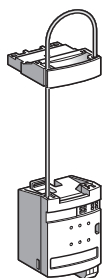

| Type                       | Connection module             |           |               |           |
|----------------------------|-------------------------------|-----------|---------------|-----------|
| TeSys D coil voltage       | 12...250 V AC or 5...130 V DC |           | 24 V DC       |           |
| Type of coil control relay | Electronic                    |           | Without relay |           |
| Type of motor starter      | Direct                        | Reversing | Direct        | Reversing |
| Reference                  | LAD9AP31                      | LAD9AP32  | LAD9AP3D1     | LAD9AP3D2 |

| Type                              | 24 V DC parallel wiring module |                                       |
|-----------------------------------|--------------------------------|---------------------------------------|
|                                   | Splitter box                   | Modicon STB parallel interface module |
| PLC/motor starter side connectors | 2 x HE10/8 x RJ45              | -/4 x RJ45                            |
| Reference                         | LU9G02                         | STBEPI2145                            |

4

## Accessories

| Type           | Connecting cables |                                     |                            |                            |           |
|----------------|-------------------|-------------------------------------|----------------------------|----------------------------|-----------|
|                | (1)               | From splitter box LU9G02 to the PLC |                            |                            |           |
| Connectors     | 2 x RJ45          | 2 HE10                              |                            | Bare wires and HE10        |           |
| Gauge / c.s.a. | –                 | 22 / 0.324 mm <sup>2</sup>          | 28 / 0.080 mm <sup>2</sup> | 22 / 0.324 mm <sup>2</sup> |           |
| Reference      | L = 0.3 m         | LU9R03                              | –                          | –                          |           |
|                | 0.5 m             | –                                   | TSXCDP053                  | –                          |           |
|                | 1 m               | LU9R10                              | TSXCDP103                  | ABFH20H100                 |           |
|                | 2 m               | –                                   | TSXCDP203                  | ABFH20H200                 |           |
|                | 3 m               | LU9R30                              | TSXCDP303                  | ABFH20H300                 | TSXCDP301 |
|                | 5 m               | –                                   | TSXCDP503                  | –                          | TSXCDP301 |

(1) From connection module LAD9AP3● to splitter box LU9G02 or module STBEPI2145

| Type      | Connectors                               |                | Connecting cable   |
|-----------|--|----------------|--|
|           | Spring terminals                         | Self-stripping |  |
| Use       | External contact, auxiliary power supply |                | Between communication module APP1C● and splitter box LU9GG02 |
| Reference | APE1PRE21                                | APE1PAD21      | APP2AH40H060   |

# Components Lighting applications (AC5)

| Sodium vapour lamps               |               |     |      |      |      |     |     |                            |      |      |      |      |     |     |            |
|-----------------------------------|---------------|-----|------|------|------|-----|-----|----------------------------|------|------|------|------|-----|-----|------------|
| low pressure                      |               |     |      |      |      |     |     |                            |      |      |      |      |     |     |            |
|                                   | Non-corrected |     |      |      |      |     |     | With parallel compensation |      |      |      |      |     |     |            |
| P (W)                             | 3-            | 55  | 90   | 135  | 150  | 180 | 200 | 35                         | 55   | 90   | 135  | 150  | 180 | 200 |            |
| IB (A)                            | 1.2           | 1.6 | 2.4  | 3.1  | 3.2  | 3.3 | 3.4 | 0.3                        | 0.4  | 0.6  | 0.9  | 1    | 1.2 | 1.3 |            |
| C (µF)                            | -             | -   | -    | -    | -    | -   | -   | 17                         | 17   | 25   | 36   | 36   | 36  | 36  | LC1-       |
| Max. number of lamps              | 6             | 5   | 3    | 2    | 2    | 2   | 2   | -                          | -    | -    | -    | -    | -   | -   | K09        |
| according to P (W), per contactor | 10            | 7   | 5    | 3    | 3    | 3   | 3   | 40                         | 30   | -    | -    | -    | -   | -   | D09, D12   |
|                                   | 12            | 9   | 6    | 4    | 4    | 4   | 4   | 50                         | 37   | 25   | -    | -    | -   | -   | D18        |
|                                   | 15            | 11  | 7    | 6    | 5    | 5   | 5   | 63                         | 47   | 31   | 21   | 19   | 15  | 14  | D25        |
|                                   | 21            | 16  | 10   | 8    | 8    | 7   | 7   | 86                         | 65   | 43   | 28   | 26   | 21  | 20  | D32, D38   |
|                                   | 27            | 20  | 13   | 10   | 10   | 10  | 9   | 110                        | 82   | 55   | 36   | 33   | 27  | 25  | D40A       |
|                                   | 35            | 26  | 17   | 13   | 13   | 12  | 12  | 140                        | 105  | 70   | 46   | 42   | 35  | 32  | D50A, D65A |
|                                   | 50            | 37  | 25   | 19   | 18   | 18  | 17  | 200                        | 150  | 100  | 66   | 60   | 50  | 46  | D80, D95   |
|                                   | 100           | 75  | 50   | 38   | 36   | 36  | 34  | 400                        | 300  | 200  | 132  | 120  | 100 | 92  | D115, D150 |
|                                   | 140           | 104 | 70   | 54   | 52   | 50  | 48  | 560                        | 420  | 280  | 186  | 168  | 140 | 128 | F185       |
|                                   | 152           | 114 | 76   | 58   | 56   | 54  | 54  | 606                        | 454  | 302  | 202  | 182  | 152 | 140 | F225       |
|                                   | 174           | 130 | 88   | 68   | 66   | 64  | 62  | 700                        | 524  | 350  | 232  | 210  | 174 | 162 | F265       |
|                                   | 198           | 148 | 98   | 76   | 74   | 72  | 70  | 792                        | 594  | 396  | 264  | 238  | 198 | 182 | F330       |
|                                   | 250           | 188 | 124  | 96   | 94   | 90  | 88  | 1002                       | 752  | 502  | 334  | 300  | 250 | 252 | F400       |
|                                   | 338           | 254 | 168  | 130  | 126  | 122 | 118 | 1352                       | 1014 | 676  | 450  | 406  | 338 | 312 | F500       |
|                                   | 496           | 372 | 248  | 192  | 186  | 180 | 174 | 1982                       | 1488 | 992  | 660  | 594  | 496 | 458 | F600, F800 |
| high pressure                     |               |     |      |      |      |     |     |                            |      |      |      |      |     |     |            |
| P (W)                             | 150           | 250 | 400  | 700  | 1000 |     |     | 150                        | 250  | 400  | 700  | 1000 |     |     |            |
| IB (A)                            | 1.9           | 3.2 | 5    | 8.8  | 12.4 |     |     | 0.84                       | 1.4  | 2.2  | 3.9  | 5.5  |     |     |            |
| C (µF)                            | -             | -   | -    | -    | -    |     |     | 20                         | 32   | 48   | 96   | 120  |     |     | LC1-       |
| Max. number of lamps              | 4             | 2   | 1    | -    | -    |     |     | -                          | -    | -    | -    | -    |     |     | K09        |
| according to P (W), per contactor | 6             | 3   | 2    | 1    | -    |     |     | -                          | -    | -    | -    | -    |     |     | D09, D12   |
|                                   | 7             | 4   | 3    | 1    | 1    |     |     | 17                         | -    | -    | -    | -    |     |     | D18        |
|                                   | 10            | 5   | 3    | 2    | 1    |     |     | 22                         | 13   | 8    | -    | -    |     |     | D25        |
|                                   | 13            | 8   | 5    | 2    | 2    |     |     | 30                         | 18   | 11   | 6    | -    |     |     | D32, D38   |
|                                   | 17            | 10  | 6    | 3    | 2    |     |     | 39                         | 23   | 15   | 8    | 6    |     |     | D40A       |
|                                   | 22            | 13  | 8    | 4    | 3    |     |     | 50                         | 30   | 19   | 10   | 7    |     |     | D50A, D65A |
|                                   | 31            | 18  | 12   | 6    | 4    |     |     | 71                         | 42   | 27   | 15   | 10   |     |     | D80, D95   |
|                                   | 62            | 36  | 24   | 12   | 8    |     |     | 142                        | 84   | 54   | 30   | 20   |     |     | D115, D150 |
|                                   | 88            | 52  | 34   | 18   | 14   |     |     | 200                        | 120  | 76   | 42   | 30   |     |     | F185       |
|                                   | 96            | 56  | 36   | 20   | 16   |     |     | 216                        | 130  | 82   | 46   | 32   |     |     | F225       |
|                                   | 110           | 66  | 42   | 24   | 18   |     |     | 250                        | 150  | 94   | 54   | 38   |     |     | F265       |
|                                   | 124           | 74  | 48   | 26   | 20   |     |     | 282                        | 170  | 108  | 60   | 42   |     |     | F330       |
|                                   | 158           | 94  | 60   | 34   | 24   |     |     | 358                        | 214  | 136  | 76   | 54   |     |     | F400       |
|                                   | 214           | 126 | 80   | 46   | 32   |     |     | 482                        | 290  | 184  | 104  | 74   |     |     | F500       |
|                                   | 312           | 186 | 118  | 68   | 48   |     |     | 708                        | 424  | 270  | 152  | 108  |     |     | F630, F800 |
| Metal iodine vapour lamps         |               |     |      |      |      |     |     |                            |      |      |      |      |     |     |            |
| P (W)                             | 250           | 400 | 1000 | 2000 |      |     |     | 250                        | 400  | 1000 | 2000 |      |     |     |            |
| IB (A)                            | 2.5           | 3.6 | 9.5  | 20   |      |     |     | 1.4                        | 2    | 5.3  | 11.2 |      |     |     |            |
| C (µF)                            | -             | -   | -    | -    |      |     |     | 32                         | 32   | 64   | 140  |      |     |     | LC1-       |
| Max. number of lamps              | 3             | 2   | -    | -    |      |     |     | -                          | -    | -    | -    |      |     |     | K09        |
| according to P (W), per contactor | 4             | 3   | 1    | -    |      |     |     | -                          | -    | -    | -    |      |     |     | D09, D12   |
|                                   | 6             | 4   | 1    | -    |      |     |     | -                          | -    | -    | -    |      |     |     | D18        |
|                                   | 7             | 5   | 2    | -    |      |     |     | 13                         | 9    | -    | -    |      |     |     | D25        |
|                                   | 10            | 7   | 2    | 1    |      |     |     | 18                         | 13   | 4    | -    |      |     |     | D32, D38   |
|                                   | 13            | 9   | 3    | 1    |      |     |     | 23                         | 16   | 6    | -    |      |     |     | D40A       |
|                                   | 16            | 11  | 4    | 2    |      |     |     | 30                         | 21   | 7    | -    |      |     |     | D50A, D65A |
|                                   | 24            | 16  | 6    | 3    |      |     |     | 42                         | 30   | 11   | 5    |      |     |     | D80, D95   |
|                                   | 48            | 32  | 12   | 6    |      |     |     | 84                         | 60   | 22   | 10   |      |     |     | D115, D150 |
|                                   | 66            | 46  | 18   | 8    |      |     |     | 120                        | 84   | 32   | 14   |      |     |     | F185       |
|                                   | 72            | 50  | 20   | 10   |      |     |     | 130                        | 90   | 34   | 16   |      |     |     | F225       |
|                                   | 84            | 58  | 22   | 12   |      |     |     | 150                        | 104  | 40   | 18   |      |     |     | F265       |
|                                   | 94            | 66  | 24   | 14   |      |     |     | 170                        | 118  | 44   | 20   |      |     |     | F330       |
|                                   | 120           | 84  | 32   | 16   |      |     |     | 214                        | 150  | 56   | 26   |      |     |     | F400       |
|                                   | 162           | 112 | 42   | 20   |      |     |     | 290                        | 202  | 76   | 36   |      |     |     | F500       |
|                                   | 238           | 164 | 62   | 30   |      |     |     | 424                        | 298  | 112  | 52   |      |     |     | F630, F800 |

## Incandescent and halogen lamps

|                                   |      |      |      |      |      |      |      |      |      |            |
|-----------------------------------|------|------|------|------|------|------|------|------|------|------------|
| P (W)                             | 60   | 75   | 100  | 150  | 200  | 300  | 500  | 750  | 1000 |            |
| IB (A)                            | 0.27 | 0.34 | 0.45 | 0.68 | 0.91 | 1.40 | 2.30 | 3.40 | 4.60 | LC1-       |
| Max. number of lamps              | 35   | 28   | 21   | 14   | 10   | 6    | 4    | 2    | 2    | K09        |
| according to P (W), per contactor | 59   | 47   | 35   | 23   | 17   | 11   | 7    | 4    | 3    | D09, D12   |
|                                   | 77   | 61   | 46   | 30   | 23   | 15   | 9    | 6    | 4    | D18        |
|                                   | 92   | 73   | 55   | 36   | 27   | 18   | 11   | 7    | 5    | D25        |
|                                   | 129  | 103  | 77   | 51   | 38   | 25   | 15   | 10   | 7    | D32, D38   |
|                                   | 163  | 129  | 97   | 64   | 48   | 31   | 19   | 13   | 9    | D40A       |
|                                   | 207  | 164  | 124  | 82   | 62   | 40   | 24   | 16   | 12   | D50A, D65A |
|                                   | 296  | 235  | 177  | 117  | 88   | 57   | 34   | 23   | 17   | D80, D95   |
|                                   | 430  | 340  | 256  | 170  | 126  | 82   | 50   | 34   | 24   | D115       |
|                                   | 466  | 370  | 280  | 184  | 138  | 90   | 54   | 36   | 26   | D150       |
|                                   | 710  | 564  | 426  | 282  | 210  | 136  | 82   | 56   | 40   | F185       |
|                                   | 770  | 610  | 462  | 304  | 228  | 148  | 90   | 60   | 44   | F225       |
|                                   | 888  | 704  | 532  | 352  | 262  | 170  | 104  | 70   | 52   | F265       |
|                                   | 1006 | 800  | 604  | 400  | 298  | 194  | 118  | 80   | 58   | F330       |
|                                   | 1274 | 1010 | 764  | 504  | 378  | 244  | 148  | 100  | 74   | F400       |
|                                   | 1718 | 1364 | 1030 | 682  | 508  | 330  | 200  | 136  | 100  | F500       |
|                                   | 2328 | 1850 | 1396 | 924  | 690  | 448  | 272  | 184  | 136  | F600       |
|                                   | 2776 | 2204 | 1666 | 1102 | 824  | 534  | 326  | 220  | 162  | F800       |

## Fluorescent lamps with starter

### single fitting

|                                   | Non-corrected |      |      |      |     | With parallel correction |      |      |      |      |            |
|-----------------------------------|---------------|------|------|------|-----|--------------------------|------|------|------|------|------------|
|                                   | 20            | 40   | 65   | 80   | 110 | 20                       | 40   | 65   | 80   | 110  |            |
| P (W)                             | 0.39          | 0.45 | 0.70 | 0.80 | 1.2 | 0.17                     | 0.26 | 0.42 | 0.52 | 0.72 |            |
| IB (A)                            | -             | -    | -    | -    | -   | 5                        | 5    | 7    | 7    | 16   | LC1-       |
| C (µF)                            | 24            | 21   | 13   | 12   | 8   | 56                       | 36   | 22   | 18   | -    | K09        |
| Max. number of lamps              | 41            | 35   | 22   | 20   | 13  | 94                       | 61   | 38   | 30   | 22   | D09, D12   |
| according to P (W), per contactor | 53            | 46   | 30   | 26   | 17  | 123                      | 80   | 50   | 40   | 29   | D18        |
|                                   | 66            | 57   | 37   | 32   | 21  | 152                      | 100  | 61   | 50   | 36   | D25        |
|                                   | 89            | 77   | 50   | 43   | 29  | 205                      | 134  | 83   | 67   | 48   | D32, D38   |
|                                   | 112           | 97   | 62   | 55   | 36  | 258                      | 169  | 104  | 84   | 61   | D40A       |
|                                   | 143           | 124  | 80   | 70   | 46  | 329                      | 215  | 133  | 107  | 77   | D50A, D65A |
|                                   | 205           | 177  | 114  | 100  | 66  | 470                      | 367  | 190  | 153  | 111  | D80, D95   |
|                                   | 410           | 354  | 228  | 200  | 132 | 940                      | 614  | 380  | 306  | 222  | D115, D150 |
|                                   | 492           | 426  | 274  | 240  | 160 | 1128                     | 738  | 456  | 368  | 266  | F185       |
|                                   | 532           | 462  | 296  | 260  | 172 | 1224                     | 800  | 490  | 400  | 288  | F225       |
|                                   | 614           | 532  | 342  | 300  | 200 | 1412                     | 922  | 570  | 462  | 332  | F265       |
|                                   | 696           | 604  | 388  | 340  | 226 | 1600                     | 1046 | 648  | 522  | 378  | F330       |
|                                   | 882           | 764  | 490  | 430  | 286 | 2024                     | 1322 | 818  | 662  | 478  | F400       |
|                                   | 1190          | 1030 | 662  | 580  | 386 | 2728                     | 1724 | 1104 | 892  | 644  | F500       |
|                                   | 1612          | 1398 | 698  | 786  | 524 | 3700                     | 2418 | 1498 | 1210 | 874  | F630, F800 |

### twin fitting

|                                   |        |        |        |        |       |        |        |        |        |        |            |
|-----------------------------------|--------|--------|--------|--------|-------|--------|--------|--------|--------|--------|------------|
| P (W)                             | 2x20   | 2x40   | 2x65   | 2x80   | 2x110 | 2x20   | 2x40   | 2x65   | 2x80   | 2x110  |            |
| IB (A)                            | 2x0.22 | 2x0.41 | 2x0.67 | 2x0.82 | 2x1.1 | 2x0.13 | 2x0.24 | 2x0.39 | 2x0.48 | 2x0.65 | LC1-       |
| Max. number of lamps              | 2x21   | 2x11   | 2x7    | 2x5    | 2x4   | 2x36   | 2x20   | 2x12   | 2x10   | 2x7    | K09        |
| according to P (W), per contactor | 2x36   | 2x18   | 2x10   | 2x8    | 2x6   | 2x60   | 2x32   | 2x20   | 2x16   | 2x12   | D09, D12   |
|                                   | 2x46   | 2x24   | 2x14   | 2x12   | 2x8   | 2x80   | 2x42   | 2x26   | 2x20   | 2x16   | D18        |
|                                   | 2x58   | 2x30   | 2x18   | 2x14   | 2x10  | 2x100  | 2x54   | 2x32   | 2x26   | 2x20   | D25        |
|                                   | 2x78   | 2x42   | 2x26   | 2x20   | 2x14  | 2x134  | 2x72   | 2x44   | 2x36   | 2x26   | D32, D38   |
|                                   | 2x100  | 2x52   | 2x32   | 2x26   | 2x18  | 2x168  | 2x90   | 2x56   | 2x44   | 2x32   | D40A       |
|                                   | 2x126  | 2x68   | 2x40   | 2x34   | 2x24  | 2x214  | 2x116  | 2x70   | 2x58   | 2x42   | D50A, D65A |
|                                   | 2x180  | 2x96   | 2x58   | 2x48   | 2x36  | 2x306  | 2x166  | 2x102  | 2x82   | 2x60   | D80, D95   |
|                                   | 2x360  | 2x194  | 2x118  | 2x96   | 2x72  | 2x614  | 2x332  | 2x204  | 2x166  | 2x122  | D115, D150 |
|                                   | 2x436  | 2x234  | 2x142  | 2x116  | 2x86  | 2x738  | 2x400  | 2x246  | 2x200  | 2x148  | F185       |
|                                   | 2x472  | 2x254  | 2x154  | 2x126  | 2x94  | 2x800  | 2x432  | 2x266  | 2x216  | 2x160  | F225       |
|                                   | 2x544  | 2x292  | 2x178  | 2x146  | 2x108 | 2x922  | 2x500  | 2x308  | 2x250  | 2x184  | F265       |
|                                   | 2x618  | 2x332  | 2x202  | 2x166  | 2x124 | 2x1046 | 2x566  | 2x348  | 2x282  | 2x208  | F330       |
|                                   | 2x782  | 2x420  | 2x256  | 2x210  | 2x156 | 2x1322 | 2x716  | 2x440  | 2x358  | 2x264  | F400       |
|                                   | 2x1054 | 2x566  | 2x346  | 2x282  | 2x210 | 2x1784 | 2x966  | 2x594  | 2x482  | 2x356  | F500       |
|                                   | 2x1430 | 2x766  | 2x468  | 2x384  | 2x286 | 2x2418 | 2x1310 | 2x806  | 2x654  | 2x484  | F630, F800 |

# Components Capacitor switching

## 0...1000 kVAR

### On-load capacitor switching

for bar-mounted contactors, a.c. control circuit

| Rated operational voltage (V) | Without damping resistor |                              |            |                                  | With damping resistor |                              |        |                                  |
|-------------------------------|--------------------------|------------------------------|------------|----------------------------------|-----------------------|------------------------------|--------|----------------------------------|
|                               | Number of poles          | Max. operational current (A) |            | Basic reference, to be completed | Number of poles       | Max. operational current (A) |        | Basic reference, to be completed |
|                               |                          | 50 Hz                        | 180 Hz     |                                  |                       | 50 Hz                        | 180 Hz |                                  |
| 1300                          | 1                        | 80                           | 60         | CE5FB11•11                       | 1 + 1 staggered pole  | 80                           | 60     | CE6FB12•11                       |
|                               |                          | 160                          | 125        | CE5GB11•11                       |                       | 160                          | 125    | CE6GB12•11                       |
|                               |                          | 240                          | 190        | CE5HB11•11                       |                       | 240                          | 190    | CE6HB12•11                       |
|                               | 2                        | 80x2                         | 60x2       | CE5FB21•11                       | 2 + 2 staggered poles | 240x2                        | 190x2  | CE6HB22•11                       |
|                               |                          | 160x2                        | 125x2      | CE5GB21•11                       |                       |                              |        |                                  |
|                               |                          | 240x2                        | 190x2      | CE5HB21•11                       |                       |                              |        |                                  |
| 3                             | 80x3                     | 60x3                         | CE5FB31•11 | 1 + 2 staggered poles            |                       |                              |        |                                  |
|                               | 160x3                    | 125x3                        | CE5GB31•11 |                                  |                       |                              |        |                                  |
|                               | 240x3                    | 190x3                        | CE5HB31•11 |                                  |                       |                              |        |                                  |
| 1500                          | 2 poles in series        | 160                          | 125        | CE5GB12•11                       |                       | 160                          | 125    | CE6GB13•11                       |
|                               |                          | 280                          | 220        | CE5HB12•11                       |                       | 280                          | 220    | CE6HB13•11                       |
|                               | 2 x 2 poles in series    | 280x2                        | 220x2      | CE5HB22•11                       |                       |                              |        |                                  |
| 2000                          | 2 poles in series        | 240                          | 190        | CS5HB12•11                       | 1 + 2 staggered poles | 240                          | 190    | CS6HB13•11                       |
|                               | 2 x 2 poles in series    | 240x2                        | 190x2      | CS5HB22•11                       |                       |                              |        |                                  |
| 3000                          | 3 poles in series        | 280                          | 220        | CS5HB13•11                       | 1 + 3 staggered poles | 280                          | 220    | CS6HB14•11                       |

### Standard control circuit voltages

~ supply

| Volts            | 110 | 125 | 127 | 200 | 220 | 240 | 250 | 380 | 415 | 440 | 500 |
|------------------|-----|-----|-----|-----|-----|-----|-----|-----|-----|-----|-----|
| 50 Hz (coil LX1) | F   | -   | G   | L   | M   | U   | -   | Q   | N   | R   | S   |

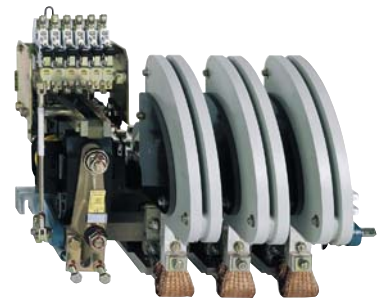

### Maximum operational power of contactors standard contactors

Operational power at 50/60 Hz

|     | $\theta \geq 40\text{ }^\circ\text{C}$ |       |       | $\theta \geq 55\text{ }^\circ\text{C}$ |       |       | Peak current | Contactor size |
|-----|--|-------|-------|--|-------|-------|--------------|----------------|
|     | 220 V                                  | 400 V | 600 V | 220 V                                  | 400 V | 600 V |              |                |
|     | 240 V                                  | 440 V | 690 V | 240 V                                  | 440 V | 690 V |              |                |
|     | kVAR                                   | kVAR  | kVAR  | kVAR                                   | kVAR  | kVAR  | A            |                |
| 6   | 11                                     | 15    | 15    | 6                                      | 11    | 15    | 560          | LC1D09, D12    |
| 9   | 15                                     | 20    | 20    | 9                                      | 15    | 20    | 850          | LC1D18         |
| 11  | 20                                     | 25    | 25    | 11                                     | 20    | 25    | 1600         | LC1D25         |
| 14  | 25                                     | 30    | 30    | 14                                     | 25    | 30    | 1900         | LC1D32, D38    |
| 17  | 30                                     | 37    | 37    | 17                                     | 30    | 37    | 2160         | LC1D40A        |
| 22  | 40                                     | 50    | 50    | 22                                     | 40    | 50    | 2160         | LC1D50A        |
| 22  | 40                                     | 50    | 50    | 22                                     | 40    | 50    | 3040         | LC1D65A        |
| 35  | 60                                     | 75    | 75    | 35                                     | 60    | 75    | 3040         | LC1D80, D95    |
| 50  | 90                                     | 125   | 125   | 38                                     | 75    | 80    | 3100         | LC1D115        |
| 60  | 110                                    | 135   | 135   | 40                                     | 85    | 90    | 3300         | LC1D150        |
| 70  | 125                                    | 160   | 160   | 50                                     | 100   | 100   | 3500         | LC1F185        |
| 80  | 140                                    | 190   | 190   | 60                                     | 110   | 110   | 4000         | LC1F225        |
| 90  | 160                                    | 225   | 225   | 75                                     | 125   | 125   | 5000         | LC1F265        |
| 100 | 190                                    | 275   | 275   | 85                                     | 140   | 165   | 6500         | LC1F330        |
| 125 | 220                                    | 300   | 300   | 100                                    | 160   | 200   | 8000         | LC1F400        |
| 180 | 300                                    | 400   | 400   | 125                                    | 220   | 300   | 10000        | LC1F500        |
| 250 | 400                                    | 600   | 600   | 190                                    | 350   | 500   | 12000        | LC1F630        |
| 250 | 400                                    | 600   | 600   | 190                                    | 350   | 500   | 14200        | LC1F800        |
| 200 | 350                                    | 500   | 500   | 180                                    | 350   | 500   | 25000        | LC1BL          |
| 300 | 550                                    | 650   | 650   | 250                                    | 500   | 600   | 25000        | LC1BM          |
| 500 | 8350                                   | 950   | 950   | 400                                    | 750   | 750   | 25000        | LC1BP          |
| 600 | 1100                                   | 1300  | 1300  | 500                                    | 1000  | 1000  | 25000        | LC1BR          |

### special contactors

Operational power at 50/60 Hz

|     | $\theta \geq 55\text{ }^\circ\text{C}$ |       |       | Instantaneous auxiliary contacts |    | Tightening torque on cable end | Basic reference, to be completed |
|-----|--|-------|-------|----------------------------------|----|--------------------------------|----------------------------------|
|     | 220 V                                  | 400 V | 660 V |                                  |    |                                |                                  |
|     | 240 V                                  | 440 V | 690 V |                                  |    |                                |                                  |
|     | kVAR                                   | kVAR  | kVAR  | NO                               | NC | N.m                            |                                  |
| 6.7 | 12.5                                   | 18    | 18    | 1                                | 1  | 1.2                            | LC1DFK11**                       |
|     |  |       |       | -                                | 2  | 1.2                            | LC1DFK02**                       |
| 8.5 | 16.7                                   | 24    | 24    | 1                                | 1  | 1.7                            | LC1DGK11**                       |
|     |  |       |       | -                                | 2  | 1.7                            | LC1DGK02**                       |
| 10  | 20                                     | 30    | 30    | 1                                | 1  | 1.9                            | LC1DLK11**                       |
|     |  |       |       | -                                | 2  | 1.9                            | LC1DLK02**                       |
| 15  | 25                                     | 36    | 36    | 1                                | 1  | 2.5                            | LC1DMK11**                       |
|     |  |       |       | -                                | 2  | 2.5                            | LC1DMK02**                       |
| 20  | 33.3                                   | 48    | 48    | 1                                | 2  | 5                              | LC1DPK12**                       |
| 25  | 40                                     | 58    | 58    | 1                                | 2  | 5                              | LC1DTK12**                       |
| 40  | 60                                     | 92    | 92    | 1                                | 2  | 9                              | LC1DWK12**                       |

### Standard control circuit voltages

~ supply

| Volts               | 24 | 42 | 48 | 110 | 115 | 220 | 230 | 240 | 380 | 400 | 415 | 440 |
|---------------------|----|----|----|-----|-----|-----|-----|-----|-----|-----|-----|-----|
| 50/60 Hz (coil LX1) | B7 | D7 | E7 | F7  | FE7 | M7  | P7  | U7  | Q7  | V7  | N7  | R7  |



### Maximum operational current (device in open air)

| Contactors   |           |        | LC1-/LP1-<br>K09 | LC1-/LP1-<br>K12 | LC1-<br>D09 | LC1-<br>DT20 | LC1-<br>D12 | LC1-<br>D18 | LC1-<br>D25 | LC1-<br>D32 | LC1-<br>D38 | LC1-<br>D40A |
|--|-----------|--------|------------------|------------------|-------------|--------------|-------------|-------------|-------------|-------------|-------------|--------------|
| ■ 3-pole   |           |        |                  |                  |             |              |             |             |             |             |             |              |
| ■ 4-pole   |           |        |                  |                  |             |              |             |             |             |             |             |              |
| LC2- changeover contactor pairs, factory assembled |           |        |                  | K09004           | K12004      |              | DT20        | DT25        | DT32        | DT40        |             | DT60A        |
| Operational current in AC-1, in A, ≤ 40°C          | A         |        | 20               | 20               | 25          | 20           | 25          | 32          | 40          | 50          | 50          | 60           |
| according to ambient temperature ≤ 60°C            | A         |        | 20               | 20               | 25          | 20           | 25          | 32          | 40          | 50          | 50          | 60           |
|  |           | ≤ 70°C |                  |                  |             |              |             |             |             |             |             |              |
| Maximum operational power ≤ 60°C                   | 220/230 V | kW     | 8                | 8                | 9           | 8            | 9           | 11          | 14          | 18          | 18          | 21           |
|  | 240 V     | kW     | 8                | 8                | 9           | 8            | 9           | 12          | 15          | 19          | 19          | 23           |
|  | 380/400 V | kW     | 14               | 14               | 15          | 14           | 15          | 20          | 25          | 31          | 31          | 37           |
|  | 415 V     | kW     | 14               | 14               | 17          | 14           | 17          | 21          | 27          | 34          | 34          | 41           |
|  | 440 V     | kW     | 15               | 15               | 18          | 15           | 18          | 23          | 29          | 36          | 36          | 43           |
|  | 500 V     | kW     | 17               | 17               | 20          | 17           | 20          | 23          | 33          | 41          | 41          | 49           |
|  | 660/690 V | kW     | 22               | 22               | 27          | 22           | 27          | 34          | 43          | 54          | 54          | 65           |

### Increase in operational current by parallel connection of poles

Apply the following coefficients to the currents or powers above; these coefficients take into account an often unbalanced distribution of current between the poles:

- 2 poles in parallel K = 1.6
- 3 poles in parallel K = 2.25
- 4 poles in parallel K = 2.8

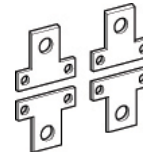

### Connection accessories for heating applications

| Paralleling links for: |                             | Reference                                 |
|------------------------|-----------------------------|---|
| ■ TeSys K              | 2 poles                     | with screw clamp terminals<br>LA9E01      |
|                        | 4 poles                     | with screw clamp terminals<br>LA9E02      |
| ■ TeSys D              | 2 poles                     | D09...D38<br>LA9D2561                     |
|                        |                             | DT20 and DT25 (4P)<br>LA9D1261            |
|                        |                             | DT32...DT40 (4P)<br>LADD96061             |
|                        | 3 poles                     | D40A...D65A<br>LAD9P32                    |
|                        |                             | D80<br>LA9D80961                          |
|                        |                             | D09...D38<br>LAD9P3 (1)                   |
| 4 poles                | D40A...D65A<br>LAD9P33      |   |
|                        | D80<br>LA9D80962            |   |
|                        | DT20...DT25<br>LA9D1263     |   |
|                        | D40A...D65A<br>2 x LAD-9P33 |   |
| ■ TeSys F              | 2 to 2                      | D80<br>LA9D80963                          |
|                        |                             | LC1F1154<br>LA9FF602                      |
|                        |                             | LC1F1504, F1854<br>LA9FG602               |
|                        |                             | LC1F2254, F2654, F3304, F4004<br>LA9FH602 |
|                        |                             | LC1F5004<br>LA9FK602                      |
| LC1F6304<br>LA9FL602   |                             |   |

(1) Link that can be split, allowing parallel connection of 2 poles



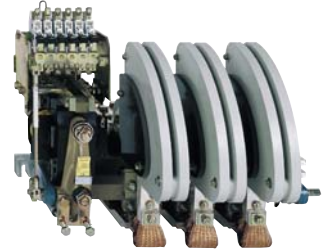

|  | LC1-D50A | LC1-D65A     | LC1-D80       | LC1-D115       | LC1-F185     | LC1-F225     | LC1-F265     | LC1-F330 | LC1-F400 | LC1-F500 | LC1-F630 | LC1-F780 | LC1-F800 | LC1-BL | LC1-BM | LC1-BP | LC1-BR |
|--|----------|--------------|---------------|----------------|--------------|--------------|--------------|----------|----------|----------|----------|----------|----------|--------|--------|--------|--------|
|  |          | <b>DT80A</b> | <b>D80004</b> | <b>D115004</b> | <b>F1854</b> | <b>F2254</b> | <b>F2654</b> |          |          |          |          |          |          |        |        |        |        |
|  | 80       | 80           | 125           | 250            | 275          | 315          | 350          | 400      | 500      | 700      | 1000     | 1600     | 1000     | 800    | 1250   | 2000   | 2750   |
|  | 80       | 80           | 125           | 200            | 275          | 280          | 300          | 360      | 430      | 580      | 850      | 1350     | 850      | 700    | 1100   | 1750   | 2400   |
|  |          |              |               |                | 180          | 200          | 250          | 290      | 340      | 500      | 700      | 1100     | 700      | 600    | 900    | 1500   | 2000   |
|  | 29       | 29           | 45            | 80             | 90           | 100          | 120          | 145      | 170      | 240      | 350      | 550      | 350      | 300    | 425    | 700    | 1000   |
|  | 31       | 31           | 49            | 83             | 100          | 110          | 125          | 160      | 180      | 255      | 370      | 570      | 370      | 330    | 450    | 800    | 1100   |
|  | 50       | 50           | 78            | 135            | 165          | 175          | 210          | 250      | 300      | 430      | 600      | 950      | 600      | 500    | 800    | 1200   | 1600   |
|  | 54       | 54           | 85            | 140            | 170          | 185          | 220          | 260      | 310      | 445      | 630      | 1000     | 630      | 525    | 825    | 1250   | 1700   |
|  | 58       | 58           | 90            | 150            | 180          | 200          | 230          | 290      | 330      | 370      | 670      | 1050     | 670      | 550    | 850    | 1400   | 2000   |
|  | 65       | 65           | 102           | 170            | 200          | 220          | 270          | 320      | 380      | 660      | 750      | 1200     | 750      | 600    | 900    | 1500   | 2100   |
|  | 86       | 86           | 135           | 235            | 280          | 300          | 370          | 400      | 530      | 740      | 1000     | 1650     | 1000     | 800    | 1100   | 1900   | 2700   |

### Mounting accessories for changeover contactor pairs

(for customer assembly)

| Contactor type   | Set of power connections | Mechanical interlock | Contactor type  | Set of power connections | Mechanical interlock |
|--|--------------------------|----------------------|---|--------------------------|----------------------|
| <b>2 contactors, vertically mounted</b>                            |                          |                      |   |                          |                      |
| ■ 4-pole changeover pairs with locking device components           |                          |                      |   |                          |                      |
| LC1B   | –                        | EZ2LB0601            | –   | –                        | –                    |
| <b>2 identical contactors, horizontally mounted</b>                |                          |                      |   |                          |                      |
| ■ with electrical interlocking kit for the contactors              |                          |                      |   |                          |                      |
| LC1DT20...DT40   | LAD-T9R1V (1)            | –                    | –   | –                        | –                    |
| ■ mechanical interlock with integral electrical interlocking       |                          |                      |   |                          |                      |
| LP1D80004  | LA9D8070                 | LA9D8002             | LC1D115004  | LA9D11570                | LA9D11502            |
| ■ without electrical interlocking (2)                              |                          |                      |   |                          |                      |
| LC1DT20...DT40   | LAD-T9R1 (2)             | –                    | –   | –                        | –                    |
| LC1DT60A & LC1DT80A  | –                        | LAD4CM (3)           | LP1D80004   | LA9D8070                 | LA9D80978            |
| <b>2 contactors of identical rating, horizontally mounted</b>      |                          |                      |   |                          |                      |
| ■ 4-pole changeover pairs  |                          |                      |   |                          |                      |
| LC1F1154   | LA9FF977                 | LA9FF970             | LC1F1504  | LA9F15077                | LA9FF970             |
| LC1F1854   | LA9FG977                 | LA9FG970             | LC1F2254  | LA9F22577                | LA9FG970             |
| LC1F2654   | LA9FH977                 | LA9FJ970             | LC1F3304  | LA9FJ977                 | LA9FJ970             |
| LC1F4004   | LA9FJ977                 | LA9FJ970             | LC1F5004  | LA9FK977                 | LA9FJ970             |
| LC1F6304   | LA9FL977                 | LA9FL970             | –   | –                        | –                    |
| ■ 3-pole changeover pairs with electrical interlocking             |                          |                      |   |                          |                      |
| LC1D115 et D150  | LA9D11571                | LA9D11502            | –   | –                        | –                    |
| <b>reversers assembled using 2 contactors, vertically mounted</b>  |                          |                      |   |                          |                      |
| ■ 4-pole changeover pairs using contactors of identical rating (3) |                          |                      | ■ 3 or 4-pole changeover pairs using contactors of different rating |                          |                      |
|  |                          |                      | At bottom   | At top                   |                      |
| LC1F1154 or F1505  | (3)                      | LA9FF4F              | LC1F115 or F1154  | LC1F185 or F1854         | LA9FG4F              |
| LC1F1854   | (3)                      | LA9FG4G              | or LC1F150 or F1504   | LC1F225 or F2254         | LA9FG4F              |
| LC1F2254   | (3)                      | LA9FG4G              |   | LC1F265 or F2654         | LA9FH4F              |
| LC1F2654 or F3304  | (3)                      | LA9FH4H              |   | LC1F300 or F3304         | LA9FH4F              |
| LC1F4004   | (3)                      | LA9FJ4J              |   | LC1F400 or F4004         | LA9FJ4F              |
| LC1F5004   | (3)                      | LA9FK4K              |   | LC1F500 or F5004         | LA9FK4F              |
| LC1F6304   | (3)                      | LA9FL4L              |   | LC1F630, F6304 or F800   | LA9FL4F              |
| LC1F7804   | (4)                      | LA9FX971 (4)         | LC1F185 or F1854  | LC1F265 or F2654         | LA9FH4G              |
|  |                          |                      | or LC1F225 or F2254   | LC1F330 or F3304         | LA9FH4G              |
|  |                          |                      |   | LC1F400 or F4004         | LA9FJ4G              |
|  |                          |                      |   | LC1F500 or F5004         | LA9FK4G              |
|  |                          |                      |   | LC1F630, F6304 or F800   | LA9FL4G              |
|  |                          |                      | LC1F265 or F2654  | LC1F400 or F4004         | LA9FJ4H              |
|  |                          |                      | or LC1F330 or F3304   | LC1F500 or F5004         | LA9FK4H              |
|  |                          |                      |   | LC1F630, F6304 or F800   | LA9FL4H              |
|  |                          |                      | LC1F400 or F4004  | LC1F500 or F5004         | LA9FK4J              |
|  |                          |                      |   | LC1F630, F6304 or F800   | LA9FL4J              |
|  |                          |                      | LC1F500 or F5004  | LC1F630, F6304 or F800   | LA9FL4K              |

(1) Including mechanical interlock.

(2) Order separately 2 auxiliary contact blocks LAD-N\*1 to obtain electrical interlocking between the two contactors.

(3) Power connections to be made by the customer.

(4) Double mechanical interlock mechanism with 2 interlock connecting rods and 4 power connecting links.

Large green-lined area for notes, consisting of a solid green header bar and a series of alternating light and medium green horizontal stripes.

# 5

Schneider Electric offers complete and compact ranges of power supplies (switch mode or filtered rectified) and transformers. With the Phaseo range, your installations will be equipped with a high quality AC or DC power supply compliant with international standards.

## Phaseo

Phaseo offers universal power supplies and protection modules with a very wide operating range to provide continuity of service for your installations. An innovative offer, Phaseo integrates numerous features which set the standard across this market.



# 5 | Power Supplies



## Power supplies

Regulated switch mode, filtered rectified power supplies

Accessories

Phaseo ABL8, ABL4, ABL1 ..... 5/2 to 5/5

## Transformers

Phaseo ABL6, ABT7 ..... 5/6

## Connection

Terminal blocks

AB1 ..... 5/8

Cable ends

DZ5/AZ5 ..... 5/9



| Type of power supply               | 7 to 60 W Single-phase                              |              |              |              |              |              |
|------------------------------------|---|--------------|--------------|--------------|--------------|--------------|
| Rated input voltage                | 100...240 VAC                                       |              |              |              |              |              |
| Rated output voltage               | 24 V  |              |              | 5 V          |              | 12 V         |
| Rated power / Rated output current | 7.5 W / 0.3 A                                       | 15 W / 0.6 A | 30 W / 1.2 A | 60 W / 2.5 A | 20 W / 4 A   | 25 W / 2 A   |
| Reset                              | Auto  |              |              |              |              |              |
| Conformity to IEC 61000-3-2        | Without   |              |              |              |              |              |
| Certifications                     | cULus, cCSAus, TUV, CE, C-Tick                      |              |              |              |              |              |
| Dimensions W x D x H (mm)          | 36 x 59 x 90  |              | 54 x 59 x 90 | 72 x 59 x 90 | 54 x 59 x 90 |              |
| Fixing (mm)                        | DIN rail 35x7.5 or 35x15 or on panel mount by screw |              |              |              |              |              |
| References                         | ABL8MEM24003  | ABL8MEM24006 | ABL8MEM24012 | ABL7RM24025  | ABL8MEM05040 | ABL8MEM12020 |



5

| Type of power supply                         | 72 to 240 W Single-phase - Wide input range |                |                |
|--|---|----------------|----------------|
| Rated input voltage                          | 100...120 VAC and 200...500 VAC             |                |                |
| Rated output voltage                         | 24 V  |                |                |
| Rated power / Rated output current           | 72 W / 3 A                                  | 120 W / 5 A    | 240 W / 10 A   |
| Permissible temporary inrush current (boost) | 1.5 In during 4 s                           |                |                |
| Reset  | Auto or manual                              |                |                |
| Conformity to IEC 61000-3-2                  | Yes   |                |                |
| Diagnostic relay (output voltage > 21.6V)    | No  | Yes            |                |
| Certifications                               | cCSAus, CB scheme, CE                       |                |                |
| Dimensions W x D x H (mm)                    | 44 x 120 x 143                              | 56 x 120 x 143 | 85 x 140 x 143 |
| Fixing (mm)                                  | DIN rail 35x7.5 or 35x15                    |                |                |
| References                                   | ABL8RPS24030                                | ABL8RPS24050   | ABL8RPS24100   |

Regulated, Switch-mode  
Compact - Rail mounting



| Type of power supply                        | 85 to 480W Single-phase |              |                |                |
|---|-------------------------|--------------|----------------|----------------|
| Rated Input Voltage AC                      | 120...230V 50/60Hz      |              | 120/230V       |                |
| Rated Input Voltage DC                      | 100...370V              |              | 300...350 V    |                |
| Rated adjustable output Voltage             | 23...27,5 V             |              |                | 24...28V       |
| Rated power / Rated output current          | 84W / 3,5A              | 120W / 5A    | 240W / 10A     | 480W / 20A     |
| Temporary permissible inrush current output | 6A for 30s              | 8A for 30s   | 15A for 30s    | 30A for 5s     |
| Reset after overload                        | Auto                    |              |                |                |
| Diagnostic relay (output voltage > 21.6V)   | Yes                     |              |                |                |
| Fixing (mm)                                 | DIN rail 35 x 7,5       |              |                |                |
| Dimensions W x D x H (mm)                   | 39 x 115 x 134          |              | 64 x 140 x 139 | 80 x 127 x 146 |
| References                                  | ABL4RSM24035            | ABL4RSM24050 | ABL4RSM24100   | ABL4RSM24200   |



### 60 to 144 W single-phase

|                                  |                     |                   |                   |
|----------------------------------|---------------------|-------------------|-------------------|
| 100...240 VAC                    |                     |                   |                   |
| 24 V                             |                     | 12 V              | 48 V              |
| 72 W / 3 A                       | 120 W / 5 A         | 60 W / 5 A        | 144 W / 2.5 A     |
| Auto                             |                     | Auto or manual    |                   |
| No                               |                     | Yes               |                   |
| cULus, cCSAus, TUV, CE, C-Tick   |                     |                   |                   |
| 27 x 120 x 120                   |                     | 54 x 120 x 120    |                   |
| DIN rail 75x7.5, 35x7.5 or 35x15 |                     |                   |                   |
| <b>ABL8REM24030</b>              | <b>ABL8REM24050</b> | <b>ABL7RP1205</b> | <b>ABL7RP4803</b> |



### 480 to 960 W single and 3-phases

|                                 |                     |                     |
|---------------------------------|---------------------|---------------------|
| 100...120 VAC and 200...240 VAC | 3 x 380...500 VAC   |                     |
| 24 V                            |                     |                     |
| 480 W / 20 A                    | 960 W / 40 A        |                     |
| 1.5 In during 4 s               |                     |                     |
| Auto or manual                  |                     |                     |
| Yes                             |                     |                     |
| Yes                             |                     |                     |
| cCSAus, CB scheme, CE           |                     |                     |
| 145 x 140 x 143                 | 95 x 155 x 143      | 165 x 155 x 143     |
| DIN rail 35x7.5 or 35x15        |                     |                     |
| <b>ABL8RPM24200</b>             | <b>ABL8WPS24200</b> | <b>ABL8WPS24400</b> |

### Type of module

### Converters DC/DC

|                                  |   |                     |
|----------------------------------|---|---------------------|
| <b>Compatibility</b>             | Output connection of power supplies ABL8RPS24..., ABL8WPS24..., ABL4RSM24... and ABL4WSR24... |                     |
| <b>Rated output voltage</b>      | 5 V   | 12 V                |
| <b>Rated output current</b>      | 6 A   | 2 A                 |
| <b>Certifications</b>            | cCSAus, CB scheme, CE   |                     |
| <b>Dimensions W x D x H (mm)</b> | 44 x 140 x 146  |                     |
| <b>Fixing (mm)</b>               | DIN rail 35x7.5 or 35x15  |                     |
| <b>References</b>                | <b>ABL8DCC05060</b>   | <b>ABL8DCC12020</b> |

5



### Type of power supply

### 480 to 960W 3-phase

|  |   |                     |                     |
|--|---|---------------------|---------------------|
| <b>Rated Input Voltage AC</b>                      | 400 ... 500V 50/60 Hz   |                     |                     |
| <b>Working on 2 phases</b>                         | Possible with output current = 75% of the nominal output current. |                     |                     |
| <b>Output Voltage</b>                              | 24V   |                     |                     |
| <b>Rated power / Rated output current</b>          | 480W / 20A  | 720W / 30A          | 960W / 40A          |
| <b>Temporary permissible inrush current output</b> | 30A for 5s  | 45A for 5s          | 60A for 5s          |
| <b>Reset after overload</b>                        | Auto  |                     |                     |
| <b>Diagnostic relay</b>                            | Yes   |                     |                     |
| <b>Fixation (mm)</b>                               | DIN rail 35 x 7,5   |                     |                     |
| <b>Dimensions W x D x H (mm)</b>                   | 80 x 127 x 146  |                     |                     |
| <b>References</b>                                  | <b>ABL4WSR24200</b>   | <b>ABL4WSR24300</b> | <b>ABL4WSR24400</b> |

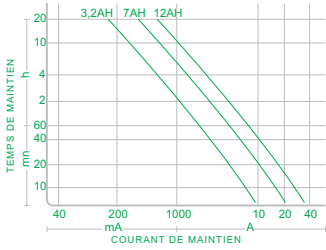

| Type of module                                 | Microcuts and cuts network solutions. (1)  |   |   |
|--|--|---|---|
| <b>Compatibility</b>                           | Output connection of Universal power supplies ABL8RPS24..., ABL8WPS24..., ABL4RSM24..., ABL4WSR24... |   |   |
| <b>Technology</b>                              | Buffer module  | battery backup module + battery                   |   |
| <b>Rated output voltage</b>                    | 40 A   | 20 A  | 40 A  |
| <b>Holding time 1A</b>                         | 2 s typique  | adjustable from 10 s to 24 H (battery depending)  |   |
| <b>Holding time for maximum current output</b> | 100 ms typique   | adjustable from 10 s to 30 mn (battery depending) | adjustable from 10 to 10 mn (battery depending) |
| <b>Certifications</b>                          | cCSAus, CB scheme, CE  |   |   |
| <b>Dimensions W x D x H (mm)</b>               | 85 x 140 x 146   | 86 x 175 x 143                                    | 86 x 175 x 143                                  |
| <b>Fixing (mm)</b>                             | DIN rail 35x7.5 or 35x15 (1)   |   |   |
| <b>References Control module</b>               | <b>ABL8BUF24400</b>  | <b>ABL8BBU24200</b>                               | <b>ABL8BBU24400</b>                             |
| <b>References battery</b>                      | 3,2AH (2)  | <b>ABL8BPK24A03</b>                               | <b>ABL8BPK24A03</b>                             |
|  | 7AH (2)  | <b>ABL8BPK24A07</b>                               | <b>ABL8BPK24A07</b>                             |
|  | 12AH (2)   | <b>ABL8BPK24A12</b>                               | <b>ABL8BPK24A12</b>                             |

(1) Battery module except 7AH and 12AH. For battery module 3.2AH with ABL1A02 kit.

(2) Battery to be chosen according to the graph page 6/2

5



| Type of module                   | Redundancy power supplies solutions   |
|----------------------------------|---|
| <b>Compatibility</b>             | Connection of 2 power supplies inputs ABL4... or ABL8RP, ABL8WP up to 20 A (1 power supply 40A) |
| <b>Rated output voltage</b>      | 24 V  |
| <b>Rated output current</b>      | 40 A  |
| <b>Certifications</b>            | cCSAus, CB scheme, CE   |
| <b>Dimensions W x D x H (mm)</b> | 44 x 140 x 146  |
| <b>Fixing (mm)</b>               | DIN rail 35x7.5 ou 35x15  |
| <b>References</b>                | <b>ABL8RED24400</b>   |

| Type of module                           | Starter protection solution   |
|--|---|
| <b>Compatibility</b>                     | Output connection of Universal power supplies ABL8RPS24100..., ABL8RPM24200..., ABL8WPS24..., ABL4RSM24... and ABL4WSR24... |
| <b>Rated output current</b>              | 10A par voie  |
| <b>Calibres</b>                          | 1 / 2.5 / 4 / 5 / 7 / 8 / 10 A  |
| <b>Number of channels</b>                | 4   |
| <b>Diagnostic relay</b>                  | Yes   |
| <b>Manual switch off (1 per channel)</b> | Two-pole  |
| <b>Certifications</b>                    | cCSAus, CB scheme, CE   |
| <b>Dimensions (mm)</b>                   | 71 x 109 x 110  |
| <b>Fixing (mm)</b>                       | DIN rail 35x7.5 or 35x15 or on panel mount by screw   |
| <b>References</b>                        | <b>ABL8PRP24100</b>   |





| Type of power supply               |                 | 60W to 240W   |               |               |                              |               |               |
|------------------------------------|-----------------|---|---------------|---------------|------------------------------|---------------|---------------|
| Input voltage                      |                 | 85...264 VAC  |               |               | 85...132 VAC / 170...264 VAC |               |               |
| Output voltage                     |                 | 12 VDC  |               | 24 VDC        |                              | 24 VDC        |               |
| Rated power / Rated output current |                 | 60 W / 5 A  | 100 W / 8.3 A | 60 W / 2.5 A  | 100 W / 4.2 A                | 150 W / 6.2 A | 240 W / 10 A  |
| Certifications                     |                 | UL, c CSA us, CE, Ctick   |               |               |                              |               |               |
| Dimensions W x D x H (mm)          |                 | 150 x 38 x 98   | 200 x 38 x 98 | 150 x 38 x 98 | 200 x 38 x 98                | 200 x 50 x 98 | 200 x 65 x 98 |
| Fixing (mm)                        |                 | Panel mount by scrow, by bracket ABL1A01 (1) , on DIN rail 35mm by panel ABL1A02 (1). |               |               |                              |               |               |
| References                         | Without filter  | ABL1REM12050  | –             | ABL1REM24025  | ABL1REM24042                 | ABL1REM24062  | ABL1REM24100  |
|                                    | With filter (2) | –   | ABL1RPM12083  | –             | ABL1RPM24042                 | ABL1RPM24062  | ABL1RPM24100  |

(1) has to order separately.

(2) Anti harmonic IEC/EN 61000-3-2

## Filtered rectified



5

| Type of power supply               |  | 12W to 480W single-phase                            |                |                |                |                         |                 |                 |                 |
|------------------------------------|--|---|----------------|----------------|----------------|-------------------------|-----------------|-----------------|-----------------|
| Input voltage                      |  | 215/230/245 V or 385/400/415 VAC                    |                |                |                |                         |                 |                 |                 |
| Rated output voltage               |  | 24 V  |                |                |                |                         |                 |                 |                 |
| Certifications                     |  | cULus, ENEC   |                |                |                |                         |                 |                 |                 |
| Rated power / Rated output current |  | 12 W / 0.5 A  | 24 W / 1 A     | 48 W / 2 A     | 96 W / 4 A     | 144 W / 6 A             | 240 W / 10 A    | 360 W / 15 A    | 480 W / 20 A    |
| Dimensions W x D x H (mm)          |  | 87 x 124 x 108                                      | 87 x 124 x 108 | 87 x 142 x 108 | 87 x 165 x 108 | 123 x 153 x 153         | 123 x 185 x 153 | 135 x 185 x 138 | 175 x 215 x 128 |
| Fixing (mm)                        |  | DIN rail 35x7.5 or 35x15 or on panel mount by screw |                |                |                | On panel mount by screw |                 |                 |                 |
| References                         |  | ABL8FEQ24005  | ABL8FEQ24010   | ABL8FEQ24020   | ABL8FEQ24040   | ABL8FEQ24060            | ABL8FEQ24100    | ABL8FEQ24150    | ABL8FEQ24200    |



| Type of power supply               |  | 240W to 1440W 3-phases  |                 |                 |                 |                 |
|------------------------------------|--|-------------------------|-----------------|-----------------|-----------------|-----------------|
| Input voltage                      |  | 3x 380 / 400 / 420 V    |                 |                 |                 |                 |
| Rated output voltage               |  | 24 V                    |                 |                 |                 |                 |
| Certifications                     |  | cULus, ENEC             |                 |                 |                 |                 |
| Rated power / Rated output current |  | 240 W / 10 A            | 480 W / 20 A    | 720 W / 30 A    | 960 W / 40 A    | 1440 W / 60 A   |
| Dimensions W x D x H (mm)          |  | 185 x 190 x 78          | 220 x 215 x 104 | 240 x 252 x 108 | 310 x 310 x 140 | 310 x 310 x 154 |
| Fixing (mm)                        |  | On panel mount by screw |                 |                 |                 |                 |
| References                         |  | ABL8TEQ24100            | ABL8TEQ24200    | ABL8TEQ24300    | ABL8TEQ24400    | ABL8TEQ24600    |



| Type of transformer                |  | Double winding operating temperature       |       |       |        |        |                         |        |        |                           |         |      |
|------------------------------------|--|--|-------|-------|--------|--------|-------------------------|--------|--------|---------------------------|---------|------|
|                                    |  | +60°C                                      |       |       |        |        | +50°C                   |        |        |                           |         |      |
| Rated input voltage                |  | 230/400 VAC (±15 V) 1-phase                |       |       |        |        |                         |        |        |                           |         |      |
| Certifications                     |  | cULus, ENEC                                |       |       |        |        |                         |        |        |                           |         |      |
| Rated power / Rated output current |  | 25 VA                                      | 40 VA | 63 VA | 100 VA | 160 VA | 250 VA                  | 320 VA | 400 VA | 630 VA                    | 1000 VA |      |
| Visualization                      |  | LED display of voltage presence at primary |       |       |        |        |                         |        |        | Without                   |         |      |
| Fixing (mm)                        |  | DIN rail 35x15 or on panel mount by screw  |       |       |        |        | On panel mount by screw |        |        |                           |         |      |
| References                         |  | ABT7PDU*** <sup>(1)</sup>                  |       |       |        |        |                         |        |        | ABT7TDU*** <sup>(1)</sup> |         |      |
| Rated output voltage               |  | 24/48 V                                    | 002B  | 004B  | 006B   | 010B   | 016B                    | 025B   | 032B   | 040B                      | 063B    | 100B |
|                                    |  | 115/230 V                                  | 002G  | 004G  | 006G   | 010G   | 016G                    | 025G   | 032G   | 040G                      | 063G    | 100G |

(1) Complete the reference according to the power and voltage using the table below (example: ABT7PDU002G)



| Type of transformer  |  | Single winding operating temperature +50°C |       |       |        |        |        |        |        |         |      |
|----------------------|--|--|-------|-------|--------|--------|--------|--------|--------|---------|------|
| Rated input voltage  |  | 230/400 VAC (±15 V) 1-phase                |       |       |        |        |        |        |        |         |      |
| Certifications       |  |  |       |       |        |        |        |        |        |         |      |
| Rated output power   |  | 25 VA                                      | 40 VA | 63 VA | 100 VA | 160 VA | 250 VA | 400 VA | 630 VA | 1000 VA |      |
| Fixing (mm)          |  | On panel mount by screw                    |       |       |        |        |        |        |        |         |      |
| References           |  | ABL6TS*** <sup>(2)</sup>                   |       |       |        |        |        |        |        |         |      |
| Rated output voltage |  | 24 V                                       | 02B   | 04B   | 06B    | 10B    | 16B    | 25B    | 40B    | 63B     | 100B |
|                      |  | 115 V                                      | 02G   | 04G   | 06G    | 10G    | 16G    | 25G    | 40G    | 63G     | 100G |
|                      |  | 230 V                                      | 02U   | 04U   | 06U    | 10U    | 16U    | 25U    | 40U    | 63U     | 100U |

(2) Complete the reference according to the power and voltage using the table below (example: ABL6TS02G)



| Type of transformer                |  | Single winding operating temperature +40°C |       |        |        |        |        |        |      |
|------------------------------------|--|--|-------|--------|--------|--------|--------|--------|------|
| Rated input voltage                |  | 230 VAC (±15 V) 1-phase                    |       |        |        |        |        |        |      |
| Certifications                     |  | Without                                    |       |        |        |        |        |        |      |
| Rated power / Rated output current |  | 40 VA                                      | 63 VA | 100 VA | 160 VA | 250 VA | 320 VA | 400 VA |      |
| Fixing (mm)                        |  | On panel mount by screw                    |       |        |        |        |        |        |      |
| References                         |  | ABT7ESM*** <sup>(3)</sup>                  |       |        |        |        |        |        |      |
| Rated output voltage               |  | 24 V                                       | 004B  | 006B   | 010B   | 016B   | 025B   | 032B   | 040B |

(3) Complete the reference according to the power and voltage using the table below (example: ABT7ESM004B)

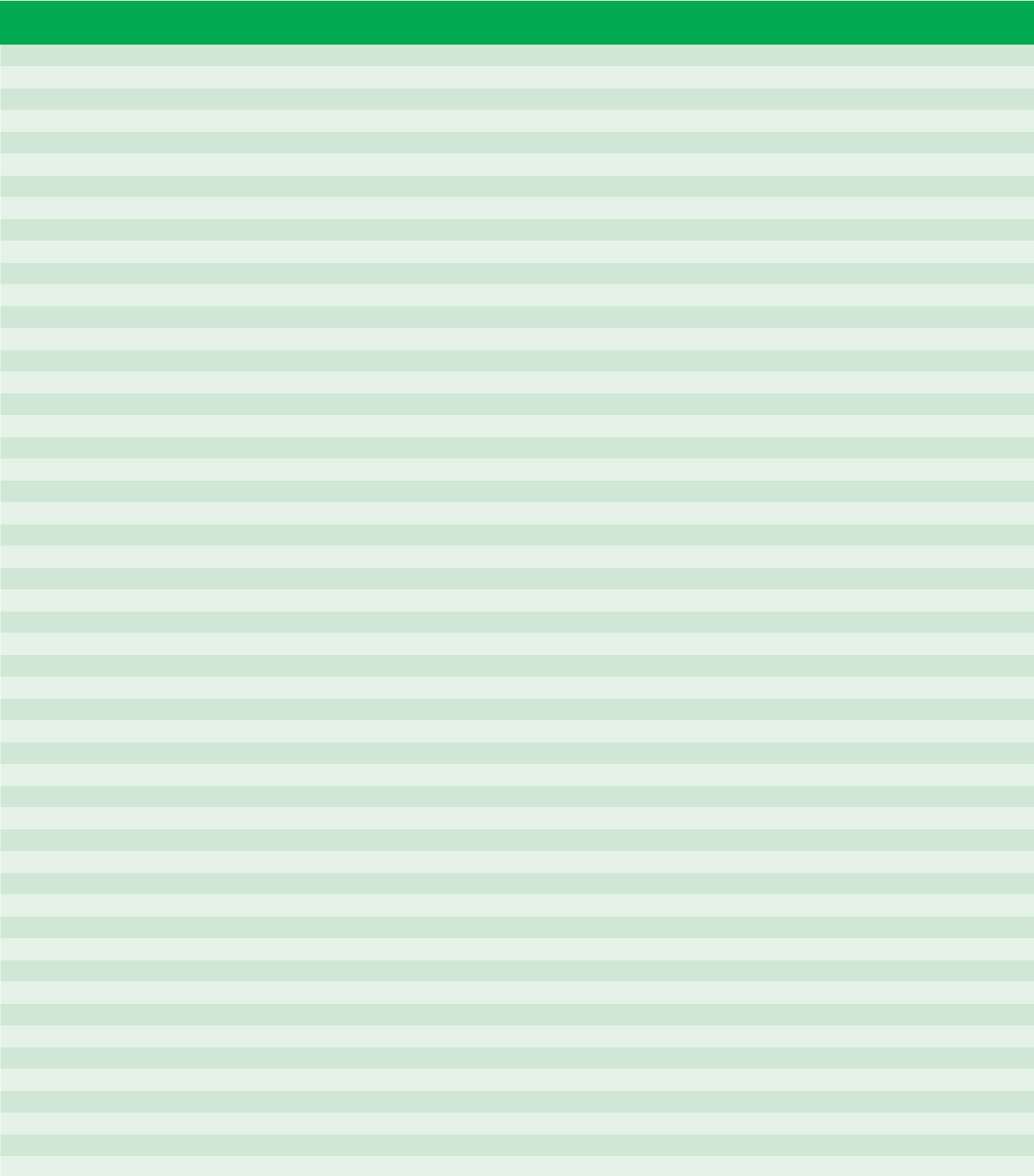

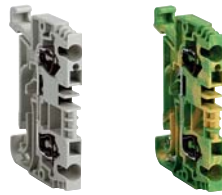

| Clip-on mounting on 35 mm $\mathbb{L}$ rails |                            | Terminal blocks<br>(sold in lots of 100) | End covers<br>(sold in lots of 100) | Commoning link<br>(sold in lots of 100) |
|--|----------------------------|--|-------------------------------------|---|
| 2.5 mm <sup>2</sup> c.s.a.                   | Conducting                 | AB1RRN235U2GR                            | AB1RRNAC242GR                       | AB1RRAL22 (1)                           |
|  | Protective earth conductor | AB1RRNTP235U2                            | AB1RRNTPAC242                       | –                                       |
| 4 mm <sup>2</sup> c.s.a.                     | Conducting                 | AB1RRN435U2GR                            | AB1RRNAC442GR                       | AB1RRAL42 (1)                           |
|  | Protective earth conductor | AB1RRNTP435U2                            | AB1RRNTPAC442                       | –                                       |
| 6 mm <sup>2</sup> c.s.a.                     | Conducting                 | AB1RRN635U2GR                            | AB1RRNAC642GR                       | AB1RRNAL62 (2)                          |
|  | Protective earth conductor | AB1RRNTP635U2                            | AB1RRNTPAC642                       | –                                       |
| 10 mm <sup>2</sup> c.s.a.                    | Conducting                 | AB1RRN1035U2GR (3)                       | AB1RRNAC1042GR                      | AB1RRNAL102                             |
|  | Protective earth conductor | AB1RRNTP1035U2 (3)                       | AB1RRNTPAC1042                      | –                                       |
| 16 mm <sup>2</sup> c.s.a.                    | Conducting                 | AB1RRN1635U2GR (3)                       | AB1RRNAC1642GR                      | AB1RRNAL162                             |
|  | Protective earth conductor | AB1RRNTP1635U2 (3)                       | AB1RRNTPAC1642                      | –                                       |
| 35 mm <sup>2</sup> c.s.a.                    | Conducting                 | AB1RRN3535U2GR (4)                       | –                                   | AB1RRAL352                              |
|  | Protective earth conductor | AB1RRNTP3535U2 (4)                       | –                                   | –                                       |

(1) For a 3, 4, 5 or 10-pole commoning link replace the last number of the reference (2) by 3, 4, 5 or 10 respectively. (Example: AB1RRAL22 becomes A1BRRAL23)

(2) For a 3, 4, 5 or 10-pole commoning link replace the last number of the reference (2) by 3, 4, 5 or 10 respectively. (Example: AB1RRNAL62 becomes A1BRRNAL64)

(3) Sold in lots of 50

(4) Sold in lots of 10

## Screw clamp technology

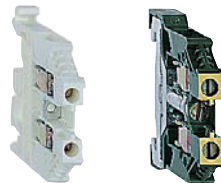

| Clip-on mounting on 35 mm $\mathbb{L}$ rails |                            | Terminal blocks<br>(sold in lots of 100) | End covers<br>(sold in lots of 100) | Commoning link<br>(sold in lots of 100) |
|--|----------------------------|--|-------------------------------------|---|
| 2.5 mm <sup>2</sup> c.s.a.                   | Conducting                 | AB1VV235U                                | AB1AC24                             | AB1ALN22 (1)                            |
|  | Protective earth conductor | AB1TP235U                                | AB1AC25                             | –                                       |
| 4 mm <sup>2</sup> c.s.a.                     | Conducting                 | AB1VV435U                                | AB1AC24                             | AB1ALN42 (1)                            |
|  | Protective earth conductor | AB1TP435U                                | –                                   | –                                       |
| 6 mm <sup>2</sup> c.s.a.                     | Conducting                 | AB1VV635U                                | AB1AC6                              | AB1ALN62 (1)                            |
|  | Protective earth conductor | AB1TP635U                                | –                                   | –                                       |
| 10 mm <sup>2</sup> c.s.a.                    | Conducting                 | AB1VVN1035U (2)                          | AB1ACN10                            | AB1ALN102 (1)                           |
|  | Protective earth conductor | AB1TP1035U (2)                           | –                                   | –                                       |
| 16 mm <sup>2</sup> c.s.a.                    | Conducting                 | AB1VVN1635U (2)                          | AB1ACN16                            | AB1ALN162 (1)                           |
|  | Protective earth conductor | AB1TP1635U (2)                           | –                                   | –                                       |
| 35 mm <sup>2</sup> c.s.a.                    | Conducting                 | AB1VVN3535U (3)                          | –                                   | AB1ALN352 (1)                           |
|  | Protective earth conductor | AB1TP3535U (3)                           | –                                   | –                                       |
| 70 mm <sup>2</sup> c.s.a.                    | Conducting                 | AB1VVN7035U (3)                          | –                                   | AB1ALN702                               |
| 150 mm <sup>2</sup> c.s.a.                   | Conducting                 | AB1VVN15035U (4)                         | –                                   | AB1ALN1502 (1)                          |

(1) For a 3, 4, 5 or 10-pole commoning link replace the last number of the reference (2) by 3, 4, 5 or 10 respectively. (Example: AB1ALN22 becomes AB1ALN23)

(2) Sold in lots of 50

(3) Sold in lots of 20

(4) Sold in lots of 10

## Insulation displacement technology



| Clip-on mounting on 35 mm $\mathbb{L}$ rails |                            | 2-way terminal blocks<br>(sold in lots of 100) | End covers<br>(sold in lots of 10) | 2-pole commoning link (1)<br>(sold in lots of 10) |
|--|----------------------------|--|------------------------------------|---|
| 1 mm <sup>2</sup> c.s.a.                     | Conducting                 | AB1AA135U2GR                                   | AB1AAAC122GR                       | AB1RRAL22   |
|  | Protective earth conductor | AB1AATP135U2                                   | AB1AAAC122VE                       | –   |
| 2.5 mm <sup>2</sup> c.s.a.                   | Conducting                 | AB1AA235U2GR                                   | AB1AAAC122GR                       | AB1RRAL22   |
|  | Protective earth conductor | AB1AATP235U2                                   | AB1AAAC122VE                       | –   |

(1) For a 3, 4, 5 or 10-pole commoning link replace the last number of the reference (2) by 3, 4, 5 or 10 respectively. (Example: AB1RAL22 becomes AB1RAL23).

| mm <sup>2</sup> | Øb  | Øb1 | c    |
|-----------------|-----|-----|------|
| 0.5             | 3   | 1.4 | 13   |
| 0.75            | 3.1 | 1.6 | 13   |
| 1               | 3.4 | 1.8 | 13.5 |
| 1.5             | 4   | 2.1 | 13.5 |
| 2.5             | 4.6 | 2.7 | 14.5 |

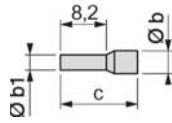

| Type                                   |      |       | Single cable ends<br>Sold in lots of 10 x 100 |                |                     |
|--|------|-------|---|----------------|---------------------|
| Packaging                              |      |       | Individual or "strings" of bags               | Dispenser pack | Strips of 50 in bag |
| Conductor c.s.a.<br>in mm <sup>2</sup> | 0.5  | White | DZ5CE005D                                     | AZ5CE005D      | DZ5CEB005D          |
|  | 0.75 | Grey  | DZ5CE007D                                     | AZ5CE007D      | DZ5CEB007D          |
|  | 1    | Red   | DZ5CE010D                                     | AZ5CE010D      | DZ5CEB010D          |
|  | 1.5  | Black | DZ5CE015D                                     | AZ5CE015D      | DZ5CEB015D          |
|  | 2.5  | Blue  | DZ5CE025D                                     | AZ5CE025D      | DZ5CEB025D          |

| mm <sup>2</sup> | Øb        | Øb1  | c    | c1 |
|-----------------|-----------|------|------|----|
| 0.75            | 2.8 x 5   | 1.8  | 15   | 8  |
| 1               | 3.4 x 5.4 | 2.05 | 15   | 8  |
| 1.5             | 3.6 x 6.6 | 2.3  | 15   | 8  |
| 2.5             | 4.2 x 7.8 | 2.9  | 18.5 | 10 |

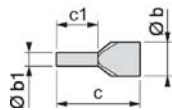

| Type                                   |          |       | Double cable ends<br>Sold in lots of 5 x 100 |  |  |
|--|----------|-------|--|--|--|
| Packaging                              |          |       | Dispenser pack                               |  |  |
| Conductor c.s.a.<br>in mm <sup>2</sup> | 2 x 0.75 | Grey  | AZ5DE007D                                    |  |  |
|  | 2 x 1    | Red   | AZ5DE010D                                    |  |  |
|  | 2 x 1.5  | Black | AZ5DE015D                                    |  |  |
|  | 2 x 2.5  | Blue  | AZ5DE025D                                    |  |  |

(1) For insulated cable ends conforming to standard NF C 63-023, please refer to your Schneider Electric agency.

## Wiring accessories

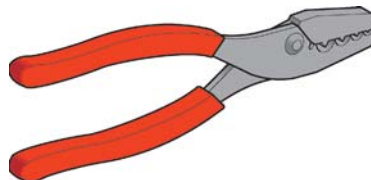

| Type             | Pliers/cutters            |                          |                           |                           |                                |
|------------------|---------------------------|--------------------------|---------------------------|---------------------------|--------------------------------|
| Functions        | Stripping                 | Cutting/stripping        | Crimping                  | Crimping (ratchet)        | Cutting/stripping/crimping (2) |
| For cable c.s.a. | 0.08 to 4 mm <sup>2</sup> | 0.4 to 4 mm <sup>2</sup> | 0.5 to 16 mm <sup>2</sup> | 0.25 to 6 mm <sup>2</sup> | 0.5 to 2.5 mm <sup>2</sup>     |
| References       | AT1PA7                    | AT2PE1                   | AT1PA2                    | AT2PA5                    | AT2TRIF01                      |

(2) For use with cable ends packed in strips of 50.

# 6

From simple connectors to integrated I/O platforms, monobloc products to modular solutions, Modicon I/O presents an extensive range of interfaces and I/O for any application.

## Modicon I/O

The compact dimensions and pre-wired system characteristic of the Modicon I/O range allow you to optimise installation time, minimise costs and the risk of error, as well as simplify maintenance.



# 6 | Interfaces and I/O



## Distributed I/O

|   |            |
|---|------------|
| <b>IP20</b>   |            |
| Optimum modular I/O system, for simple machines, <b>Modicon OTB</b> .....                       | 6/2        |
| Modular I/O system for complexes machines or installations, <b>Modicon TM5</b> .....            | 6/3        |
| Modular I/O with device integration capabilities, <b>Modicon STB</b> .....                      | 6/4 to 6/7 |
| <b>IP67</b>   |            |
| Modular I/O system for machines or installations in harsh environment, <b>Modicon TM7</b> ..... | 6/8        |

## Distributed I/O with embedded control

|  |             |
|--|-------------|
| <b>IP20</b>                              |             |
| Block I/O, <b>Modicon Momentum</b> ..... | 6/9 to 6/12 |

## Pre-wired interfaces

|   |              |
|---|--------------|
| <b>IP20</b>                                       |              |
| Sub-bases, <b>Modicon ABE7</b> .....              | 6/13 to 6/15 |
| <b>IP67</b>                                       |              |
| Passive splitter boxes, <b>Modicon ABE9</b> ..... | 6/16         |

## Accessories and Cabling

|   |      |
|---|------|
| Connection cables and jumper cables ..... | 6/17 |
|---|------|

# Modicon OTB \_\_\_\_\_ IP 20 distributed I/O, optimum system Interface modules



| Discrete Type of bus                | CANopen<br>Machine bus  | Ethernet TCP/IP<br>network (2)   | Modbus Series<br>network |
|-------------------------------------|---|--|--------------------------|
| Number of I/Os                      | 20 I/O  |  |                          |
| Number of inputs                    | 12 inputs 24 VDC IEC type 1   |  |                          |
| Number of outputs                   | 6 relay outputs and 2 solid state 24 VDC outputs  |  |                          |
| Connection method                   | Removable terminal block  |  |                          |
| Number of I/O expansion modules (1) | 7 discrete or analogue input/output modules, or connection accessories  |  |                          |
| Maximum I/O configuration           | With interface module base: 132 with screw terminal I/O expansion;<br>244 with HE10 connector I/O expansion; up to 48 analogue channels |  |                          |
| Supply voltage                      | 24 VDC  |  |                          |
| Counting                            | 5 kHz   | 2 channels, 32 bits (0...4 294 967 295 points)<br>dedicated discrete inputs -up counting/down counting with preset |                          |
|                                     | 20 kHz  | 2 channels, 32 bits (0...4 294 967 295 points)<br>up/down counting, up counting, down counting, frequency meter    |                          |
| Pulse generator, 7 kHz              | 2 PWM function channels (output with pulse width modulation)<br>or PLS function (pulse generator output)                                |  |                          |
| Dimensions W x D x H (mm)           | 55 x 70 x 90  |  |                          |
| References                          | OTB1C0DM9LP   | OTB1E0DM9LP  | OTB1S0DM9LP              |

(1) for the references of discrete I/O and analogue expansion modules, refer to the Twido or Modicon OTB catalogue

(2) Transparent Ready : Class A10

6

## Accessories

| Type of accessory | Commoning modules                             | Documentation  |
|-------------------|---|--|
| Usage             | For grouping input or output commons, max 8 A | User guides for Modicon hardware and software, and Modicon Configuration Software for Modicon OTB/FTB/FTM. Provided on CD. |
| Positioning       | Inter-module                                  | –  |
| Référence         | OTB9ZZ61JP                                    | FTXES01  |





| Type of module                         | Bus base  | CANopen electronic interface module             | Power distribution electronic module                          | Terminal block      |
|--|---|---|---|---------------------|
| Max. number of addressable I/O modules | 40 with 240 Digital Input, 240 Digital Output, 20 Input Analog & 20 Output Analog (1) |   |   |                     |
| Baud rate                              | 10 K...1 Mbps   |   |   |                     |
| Power supply                           | 24 VDC  |   |   |                     |
| Module color                           | White   | White   | Grey  | Grey                |
| Description                            | For TM5NCO1 and TM5SPS3 electronic modules  | CANopen bus communication with CANopen protocol | For the CANopen bus interface and slice I/O expansion modules | 12 spring terminals |
| References                             | TM5ACBN1  | TM5NCO1   | TM5SPS3   | TM5ACTB12PS         |

(1) Only 3 configurations maximum on CANopen fieldbus

### Digital and analogue I/O expansion blocks (2)



| Type of module                | Input     |               | Output            |           |                 |                   |
|-------------------------------|-----------|---------------|-------------------|-----------|-----------------|-------------------|
|                               | Digital   | Analog        | Digital           | Analog    |                 |                   |
| Number of inputs              | 12 sink   | –             | –                 | –         | –               | –                 |
| Number of outputs             | –         | –             | –                 | 12 source | 4 relay         | –                 |
| Number of inputs              | –         | 4             | 4                 | –         | –               | –                 |
| Number of outputs             | –         | –             | –                 | –         | –               | 4                 |
| Nominal input current         | 24 VDC    | –             | –                 | –         | –               | –                 |
| Nominal output current        | –         | –             | –                 | 24 VDC    | 30 VDC/ 230 VAC | –                 |
| Type                          | –         | Thermal probe | Voltage / Current | –         | –               | Voltage / Current |
| Associated bus sub-bases (3)  |           |               |                   |           |                 |                   |
|                               | TM5ACBM11 | TM5ACBM11     | TM5ACBM11         | TM5ACBM11 | TM5ACBM12       | TM5ACBM11         |
| Associated terminal block (3) |           |               |                   |           |                 |                   |
|                               | TM5ACTB12 | TM5ACTB12     | TM5ACTB12         | TM5ACTB12 | TM5ACTB32       | TM5ACTB12         |
| References                    | TM5SDI12D | TM5SAI4PH     | TM5SAI4L          | TM5SDO12T | TM5SDO4R        | TM5SAO4L          |

(2) Wide range of I/O expansion modules ( digital I/O, analog, expert, non-functioning dummy, remote I/O modules...), please consult our catalogue pages on [www.schneider-electric.com](http://www.schneider-electric.com).

(3) To be ordered separately



| Type of module NIM                            |                     | EtherNet<br>Modbus TCP               | Modbus TCP, dual port                 | EtherNet/IP                     |
|---|---------------------|--------------------------------------|---------------------------------------|---------------------------------|
| <b>Baud rate</b>                              |                     | 10 Mbps                              | 10/100 Mbps                           | 10/100 Mbps                     |
| <b>Transparent Ready</b>                      | Class               | B20                                  | B15                                   | N/A                             |
|   | Embedded Web server | Standard services                    | Standard services                     | Standard services               |
|   | Ethernet services   | SNMP agent, FDR, BootP & DHCP client | SNMP agent, RSTP, BootP & DHCP client | SNMP agent, BootP & DHCP client |
| <b>Max. number of addressable I/O modules</b> |                     | 32 per island                        | 32 per island                         | 32 per island                   |
| <b>Dimensions W x D x H (mm)</b>              |                     | 40 x 70 x 128.3                      | 40 x 70 x 128.3                       | 40 x 70 x 128.3                 |
| <b>Reference</b>                              | Standard            | <b>STBNIP2212</b>                    | <b>STBNIP2311</b>                     | <b>STBNIC2212</b>               |



| Type of module NIM                            |          | Machine bus<br>CANopen | Fieldbus<br>Fipio | INTERBUS              | Profibus DP           |
|---|----------|------------------------|-------------------|-----------------------|-----------------------|
| <b>Max. number of addressable I/O modules</b> |          | 32 per island (1) (2)  | 32 per island (1) | 32 per island (1) (2) | 32 per island (1) (2) |
| <b>Baud rate</b>                              |          | 10 K...1 Mbps          | 1 Mbps            | 0.5 Mbps              | 9.6 K...12 Mbps       |
| <b>Dimensions W x D x H (mm)</b>              |          | 40 x 70 x 128.3        |                   |                       |                       |
| <b>Reference</b>                              | Standard | <b>STBNCO2212</b>      | <b>STBNFP2212</b> | <b>STBNIB2212</b>     | <b>STBNDP2212</b>     |
|   | Basic    | <b>STBNCO1010</b>      | –                 | <b>STBNIB1010</b>     | <b>STBNDP1010</b>     |

- (1) On 1 primary segment and 6 expansion segments max.  
(2) 12 max on 1 primary segment for basic versions.



| Type of module                                |          | Other networks<br>Modbus Plus | DeviceNet                                    |
|---|----------|-------------------------------|--|
| <b>Max. number of addressable I/O modules</b> |          | 32 per island                 | 32 per island<br>12 per island               |
| <b>Baud rate</b>                              |          | 1 Mbps                        | 125, 250 or 500 Kbps<br>125, 250 or 500 Kbps |
| <b>Dimensions W x D x H (mm)</b>              |          | 40 x 70 x 128.3               |  |
| <b>Reference</b>                              | Standard | <b>STBNMP2212</b>             | <b>STBNDN2212</b>                            |
|   | Basic    | –                             | –<br><b>STBNDN1010</b>                       |

## Connection accessories

| Type of accessory |                  | Removable terminals for<br>24 VDC power supply | DeviceNet                     |
|-------------------|------------------|--|-------------------------------|
| <b>Use</b>        |                  | All communication modules                      | Network link DeviceNet module |
| <b>Reference</b>  | Screw terminals  | <b>STBXTS1120</b> (1)                          | <b>STBXTS1111</b>             |
|                   | Spring terminals | <b>STBXTS2120</b> (1)                          | <b>STBXTS2111</b>             |

(1) To be ordered separately, sold in lots of 10 only for spares parts. (STBXTS1120 are delivered systematically with STBN●●●●●●)

|                             |                   |
|-----------------------------|-------------------|
| <b>Marking label sheets</b> | <b>STBXMP6700</b> |
| <b>Screwdriver</b>          | <b>STBXTT0220</b> |



| Type of module                    |                    | PDM   |                            |                            |                            | Auxiliary Power supply                        |
|-----------------------------------|--------------------|---|----------------------------|----------------------------|----------------------------|---|
| Connection by removable terminals |                    | Screw STBXTS1130 (2) (3)<br>Spring STBXTS2130 (2) (3) |                            |                            |                            | Screw STBXTS1120 (2)<br>Spring STBXTS2120 (2) |
| Supply voltage                    |                    | 24 VDC  |                            | 115...230 VAC              |                            | 24 VDC  |
| Maximum current                   | Inputs (4)         | 4 A at 30°C, 2.5 A at 60°C                            |                            | 5 A at 30°C, 2.5 A at 60°C |                            | –   |
|                                   | Outputs (4)        | 8 A at 30°C, 5 A at 60°C                              |                            | 10 A at 30°C, 5 A at 60°C  |                            | –   |
|                                   | Inputs/Outputs (4) | –   | 4 A at 30°C, 2.5 A at 60°C | –                          | 4 A at 30°C, 2.5 A at 60°C | –   |
|                                   | Logic internal 5 V | –   | –                          | –                          | –                          | 1.2 A   |
| Sensor/actuator bus voltage range |                    | 19.2...30 VDC   |                            | 85...265 VAC               |                            | –   |
| Dimensions W x D x H (mm)         |                    | 18.4 x 70 x 128.3                                     |                            |                            |                            |   |
| Reference                         | Module (5)         | Standard  | STBPDT3100K                | –                          | STBPDT2100K                | –   |
|                                   |                    | Basic   | –                          | STBPDT3105K                | –                          | STBPDT2105K                                   |
|                                   | Base               |   | STBXBA2200                 |                            | STBXBA2200                 | STBXBA2100                                    |

(1) Process power supplies see chapter 6 "Power supply"

(2) To be ordered separately, sold in lots of 10.

(3) PDM connector keying pin kit STBXMP7810.

(4) PDM fuse kit STBXMP5600.

(5) Kit reference including module, base and terminal

## Bus extension modules for standard range



| Type of module                    | "EOS"<br>End of segment                                | "BOS"<br>Beginning of segment                    | Extension for CANopen<br>connection devices   |
|-----------------------------------|--|--|---|
| Connection by removable terminals | –  | Screw STBXTS1120 (1)<br>Spring STBXTS2120 (1)    | Screw STBXTS1110 (2)<br>Spring STBXTS2110 (2) |
| Use                               | For placing at end of segment<br>(except for the last) | For placing at head of each<br>extension segment | For placing at end of last<br>segment         |
| Dimensions W x D x H (mm)         | 18.4 x 70 x 128.3                                      |  |   |
| Reference                         | Module (3)   | Standard   | STBXBE1100K                                   |
|                                   |  |  | STBXBE1300K                                   |
|                                   |  |  | STBXBE2100K                                   |
|                                   | Base   |  | STBXBA2300K                                   |
|                                   |  |  | STBXBA2400                                    |
|                                   |  |  | STBXBA2000                                    |

(1) To be ordered separately, sold in lots of 10.

(2) To be ordered separately, sold in lots of 20.

(3) Kit reference including module, base and terminal

## Software and memory card



| Type                | Modicon STB, OTB, FTM, FTB configuration software<br>(PC connection cable supplied) |            |            |                |                            | Removable memory card |
|---------------------|---|------------|------------|----------------|----------------------------|-----------------------|
| Software User Guide | Single station  | 3 pack     | 10 pack    | Unlimited Site | System Alliance Integrator | –                     |
| Memory size         | –   |            |            |                |                            | 32 KB                 |
| Reference           | STBSPU1000  | STBSPU1003 | STBSPU1011 | STBSPU1130     | STBSPU1010                 | STBXMP4440            |
|                     | Hardware User Guide   |            |            |                |                            | STBSUS8800            |

## Connection accessories

| Type of accessory | Island bus expansion cable     |            |                                       |            |            |
|-------------------|--------------------------------|------------|---------------------------------------|------------|------------|
| Length            | 0.3 m                          | 1 m        | 4.5 m                                 | 10 m       | 14 m       |
| Reference         | STBXCA1001                     | STBXCA1002 | STBXCA1003                            | STBXCA1004 | STBXCA1006 |
| Type of accessory | Bus termination module or plug |            | Programmation connection cable L= 2 m |            |            |
| Reference         | STBXMP1100                     |            | STBXCA4002                            |            |            |

Connection accessories: See [www.schneider-electric.com](http://www.schneider-electric.com)



| Type of module                        |            |            | Discrete inputs   |             |             |                  |                   |              |             |
|---------------------------------------|------------|------------|-------------------|-------------|-------------|------------------|-------------------|--------------|-------------|
| Connection by removable terminals (1) | Screw (2)  |            | STBXTS1100        |             |             | STBXTS1180       |                   | STBXTS1110   |             |
|                                       |            | Spring (2) | STBXTS2100        |             |             | STBXTS2180       |                   | STBXTS2110   |             |
| Number of channels                    |            |            | 2                 | 4           | 6           | 16               | 2                 | 2 (isolated) | 2           |
| Input voltage                         |            |            | 24 VDC            |             |             |                  | 115 VAC           |              | 230 VAC     |
| Dimensions W x D x H (mm)             |            |            | 13.9 x 70 x 128.3 |             |             |                  | 18.4 x 70 x 128.3 |              |             |
| Reference                             | Module (6) | Standard   | STBDDI3230K       | STBDDI3420K | STBDDI3610K | –                | STBDAI5230K       | STBDAI5260K  | STBDAI7220K |
|                                       |            | Basic      | –                 | STBDDI3425K | STBDDI3615K | STBDDI3725KS/KC* | –                 | –            | –           |
|                                       | Base (3)   |            | STBXBA1000        |             |             | STBXBA3000       |                   | STBXBA2000   |             |

\* KS with base and screw terminals,  
KC with base and spring terminals

\*\* Without base and terminal



| Type of module                        |            |            | Discrete solid state outputs |             |             |             |             |             |                  |
|---------------------------------------|------------|------------|------------------------------|-------------|-------------|-------------|-------------|-------------|------------------|
| Connection by removable terminals (1) | Screw (2)  |            | STBXTS1100                   |             |             | STBXTS1180  |             |             |                  |
|                                       |            | Spring (2) | STBXTS2100                   |             |             | STBXTS2100  |             |             |                  |
| Number of channels                    |            |            | 2                            |             | 4           |             | 6           |             | 16               |
| Output voltage                        |            |            | 24 VDC                       |             | 24 VDC      |             | 24 VDC      |             | 24 VDC           |
| Output current                        |            |            | 0.5 A                        | 2 A         | 0.25 A      | 0.5 A       | 0.25 A      | 0.5 A       | 0.5 A            |
| Dimensions W x D x H (mm)             |            |            | 13.9 x 70 x 128.3            |             |             |             |             |             |                  |
| Reference                             | Module (6) | Standard   | STBDDO3200K                  | STBDDO3230K | –           | STBDDO3410K | –           | STBDDO3600K | –                |
|                                       |            | Basic      | –                            | –           | STBDDO3415K | –           | STBDDO3605K | –           | STBDDO3705KS/KC* |
|                                       | Base (3)   |            | STBXBA1000                   |             |             | STBXBA3000  |             |             |                  |

\* KS with base and screw terminals,  
KC with base and spring terminals

\*\* Without base and terminal



| Type of module                        |            |            | Discrete outputs       |             |                 |                         |                 |
|---------------------------------------|------------|------------|------------------------|-------------|-----------------|-------------------------|-----------------|
|                                       |            |            | Triac                  |             | Relay           |                         |                 |
| Connection by removable terminals (1) | Screw (2)  |            | STBXTS1100             |             |                 |                         |                 |
|                                       |            | Spring (2) | STBXTS2100             |             |                 |                         |                 |
| Number of channels                    |            |            | 2                      |             | 2 (isolated)    | 2 NO/NC and common      | 2NC+NO          |
| Output voltage                        |            |            | 115...230 VAC          |             | 115 VAC         | 24 VDC ou 115...230 VAC |                 |
| Output current                        |            |            | 2 A à 30°C, 1 A à 60°C |             | 2 A per contact |                         | 7 A per contact |
| Dimensions W x D x H (mm)             |            |            | 18.4 x 70 x 128.3      |             |                 |                         |                 |
| Reference                             | Module (6) | Standard   | STBDAO8210K            | STBDAO5260K | STBDRC3210K     | STBDRA3290K             |                 |
|                                       |            | Base (3)   | STBXBA2000             |             |                 |                         | STBXBA3000      |

(1) To be ordered separately, sold in lots of 20.

(2) I/O connector keying pin kit STBXMP7800

(3) Module keying pin kit STBXMP7700

(4) if connection on Telefast2 order STBXTS6510 or connection on Telefast Twido order STBXTS5510

(5) if connection on Telefast2 order STBXTS6610 or connection on Telefast Twido order STBXTS5610

(6) Kit reference including module, base and terminal

Connection accessories: See [www.schneider-electric.com](http://www.schneider-electric.com)

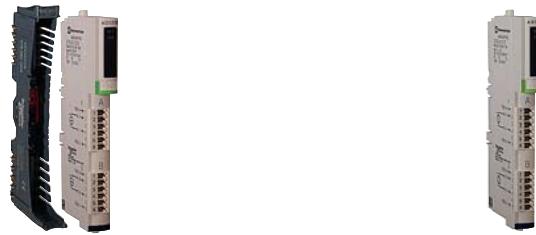

| Type of module (1)                |            | Analog inputs (*)                            |           |           |             |                    |            |                 |                |                   |                 |
|-----------------------------------|------------|--|-----------|-----------|-------------|--------------------|------------|-----------------|----------------|-------------------|-----------------|
| Connection by removable terminals |            | Screw STBXTS1100 (2) / Spring STBXTS2100 (2) |           |           |             |                    |            |                 |                |                   |                 |
| Number of channels                |            | 2  |           |           |             | 4                  |            | 8               |                | 2                 |                 |
| Input signal                      |            | - 10...+10 V                                 | 0...+10 V | 0...20 mA | 4...20 mA   | 4...20 / 0...20 mA | Selectable | Selectable      | Multirange (3) |                   |                 |
| Resolution                        |            | 11 bits + sign                               | 10 bits   | 12 bits   | 10 bits     | 15 bits + sign     |            |                 |                |                   |                 |
| Dimensions W x D x H (mm)         |            | 13.9 x 70 x 128.3                            |           |           |             | 18.4 x 70 x 128.3  |            |                 |                | 13.9 x 70 x 128.3 |                 |
| Reference                         | Module (8) | Standard                                     | -         |           | STBACI1230K | -                  |            | STBACI0320K     | STBAVI0300K    | STBACI1400K (5)   | STBART0200K     |
|                                   |            | Basic  | -         |           | STBAVI1270K | -                  |            | STBACI8320K (4) | -              |                   | STBAVI1400K (6) |
|                                   | Base       | STBXBA1000                                   |           |           |             | STBXBA2000         |            |                 |                | STBXBA1000        |                 |

(\*) For other references, see catalogue or visit our website: [www.schneider-electric.com](http://www.schneider-electric.com)



| Type of module (1)                |            | Analog outputs                               |                           |                   |               |             |                   |                |                |             |             |
|-----------------------------------|------------|--|---------------------------|-------------------|---------------|-------------|-------------------|----------------|----------------|-------------|-------------|
| Connection by removable terminals |            | Screw STBXTS1100 (2) / Spring STBXTS2100 (2) |                           |                   |               |             |                   |                |                |             |             |
| Number of channels                |            | 1  | 2                         |                   |               |             |                   |                |                |             |             |
| Output signal                     |            | 4...20 mA                                    | 0...+10, -10...+10 V      | 0...+10 V         | -10 V...+10 V | 0...20 mA   | 4...20 mA         | 4...20 mA      | Selectable (6) |             |             |
| Resolution                        |            | 15 bits + sign                               | 11 bits + sign or 12 bits | 10 bits           | 9 bits + sign | 12 bits     | 10 bits           | 15 bits + sign |                |             |             |
| Dimensions W x D x H (mm)         |            | 18.4 x 70 x 128.3                            |                           | 13.9 x 70 x 128.3 |               |             | 18.4 x 70 x 128.3 |                |                |             |             |
| Reference                         | Module (8) | Standard                                     | STBACO0120K               | STBAVO1250K       | -             |             | STBACO1210K       | -              |                | STBACO0220K | STBAVO0200K |
|                                   |            | Basic  | -                         |                   | STBAVO1255K   | STBAVO1265K | -                 |                | STBACO1225K    | -           |             |
|                                   | Base       | STBXBA2000                                   | STBXBA1000                |                   |               |             | STBXBA2000        |                |                |             |             |

## Application-specific modules



| Type of module (1)        |                   | For motor starters<br>TeSys model U | Counter                  |
|---------------------------|-------------------|-------------------------------------|--------------------------|
| Connection by connector   |                   | 4 RJ45                              | Spring STBXTS2150 (2)    |
| Number of inputs/outputs  |                   | 12 I / 8 O                          | 4 I / 2 O                |
| Input voltage             |                   | 24 VDC                              | 24 VDC                   |
| Output voltage/current    |                   | 24 VDC/0.1 A per channel            | 24 VDC/0.5 A             |
| Number of channels        |                   | 4 starters-controllers              | 1 counter channel 40 kHz |
| Dimensions W x D x H (mm) |                   | 28.1 x 70 x 128.3                   |                          |
| Reference                 | Module (8)        | Standard                            | STBEPI2145K              |
|                           | Base              | STBXBA3000                          |                          |
|                           | Connection cables | (7)                                 | -                        |

(1) Grounding kit (conseilled for counter > 40 kHz): STBXSP3000 (connecting support) + STBXSP3010 (1.5...6 mm<sup>2</sup> cables) + STBXSP3020 (5...11 mm<sup>2</sup> cables)

(2) To be ordered separately, sold in lots of 20.

(3) Multirange temperature probe thermocouples B, E, J, K, R, S, T. Thermal probe Pt 100, Pt 1000, Ni 100, Ni 1000, cu 10, ± 80 mV.

(4) 4 HART-tolerant channels (5) Input signal selectable / channel 0...20 mA and 4...20 mA (6) Input signal selectable / channel 1...5 VDC, 0...5 VDC, 0...10 VDC, ± 5 VDC and ± 10 VDC

(7) LU9R03 (0,3 m), LU9R10 (1 m), 490NTW00002 (2 m), LU9R30 (3 m), 490NTW00005 (5 m), 490NTW00012 (12 m)

(8) Kit reference including module, base and terminal



| Type of module               | CANopen interface blocks with digital I/O |                            |                            |
|------------------------------|---|----------------------------|----------------------------|
| Number of channels           | 8 I/O                                     | 16 I/O                     | 16 I/O                     |
| Number, type of inputs       | 8 sink (1)                                | 16 sink (1)                | 16 sink (1)                |
| Number, type of outputs      | 8 transistor / source (2)                 | 16 transistor / source (2) | 16 transistor / source (2) |
| Sensor / actuator connection | 8 female M8 connectors                    | 16 female M8 connectors    | 8 female M12 connectors    |
| Communication bus            | CANopen TM7 bus                           |                            |                            |
| References                   | <b>TM7NCOM08B</b>                         | <b>TM7NCOM16B</b>          | <b>TM7NCOM16A</b>          |

(1) Sink inputs: positive logic

(2) Source outputs: positive logic

### Digital I/O expansion blocks



| Type of module               | Analog I/O expansion blocks                           |                  |                   |
|------------------------------|---|------------------|-------------------|
| Input voltage                | 24 VDC IEC type 1                                     |                  |                   |
| Output voltage               | 24 VDC  |                  |                   |
| Type of inputs               | Sink (positive logic)                                 |                  |                   |
| Type of outputs              | Transistor / source (positive logic)                  |                  |                   |
| Diagnostics                  | By expansion block, channel, communication on TM7 bus |                  |                   |
| Communication bus            | TM7 bus   |                  |                   |
| Output current               | 0.5 A   |                  | 2A                |
| Sensor / actuator connection | M8 connectors   | M12 connectors   | M8 connectors     |
| References                   | 8 inputs<br><b>TM7BDI8B</b>                           | –                | –                 |
|                              | 8 configurable I/O<br><b>TM7BDM8B</b>                 | –                | –                 |
|                              | 16 inputs<br><b>TM7BDI16B</b>                         | <b>TM7BDI16A</b> | –                 |
|                              | 16 configurable I/O<br><b>TM7BDM16B</b>               | <b>TM7BDM16A</b> | –                 |
|                              | 8 outputs   | –                | <b>TM7BDO8TAB</b> |

### Analog I/O expansion blocks



| Type of module               | Analog I/O expansion blocks                           |                   |                                     |                      |
|------------------------------|---|-------------------|-------------------------------------|----------------------|
| Input range                  | Voltage   | Current 0...20 mA | Temperature probe<br>Pt100 / Pt1000 | J, K, S thermocouple |
| Output range                 | Voltage -10... + 10 V DC                              | Current 0...20 mA | –                                   | –                    |
| Type of inputs               | Sink (positive logic)                                 |                   |                                     |                      |
| Type of outputs              | Transistor / source (positive logic)                  |                   |                                     |                      |
| Diagnostics                  | By expansion block, channel, communication on TM7 bus |                   |                                     |                      |
| Communication bus            | TM7 bus   |                   |                                     |                      |
| Sensor / actuator connection | M12 connectors  |                   |                                     |                      |
| Resolution                   | 11 bit + sign   | 12 bit            | 16 bit                              | 16 bit               |
| References                   | 2 inputs/2 outputs<br><b>TM7BAM4VLA</b>               | <b>TM7BAM4CLA</b> | –                                   | –                    |
|                              | 4 inputs<br><b>TM7BAI4VLA</b>                         | <b>TM7BAI4CLA</b> | <b>TM7BAI4TLA</b>                   | <b>TM7BAI4PLA</b>    |
|                              | 4 outputs<br><b>TM7BAO4VLA</b>                        | <b>TM7BAO4CLA</b> | –                                   | –                    |

# Modicon Momentum \_\_\_\_\_ Distributed I/O and processors

## Discrete I/O modules



| Type of module            | Multibus discrete inputs  |                      |                      |             |
|---------------------------|---|----------------------|----------------------|-------------|
| Connection                | By screw terminals 170XTS00100 or spring terminals 170XTS00200 (to be ordered separately)                                       |                      |                      |             |
| Input voltage             | 24 VDC  | 120 VAC              | 230 VAC              |             |
| Number of channels        | 16 (1 common point)   | 32 (2 common points) | 16 (2 common points) |             |
| Dimensions W x D x H (mm) | 125 x 47.5 x 141.5 (with communication modules or processors)<br>144 x 70 x 141.5 (with M1/M1E processors and optional modules) |                      |                      |             |
| Reference                 | 170ADI34000   | 170ADI35000          | 170ADI54050          | 170ADI74050 |



| Type of module               | Multibus discrete outputs   |                      |                     |                      |                     |                      |
|------------------------------|---|----------------------|---------------------|----------------------|---------------------|----------------------|
|                              | Solid state   |                      |                     | Triac                |                     |                      |
| Connection                   | By screw terminals 170XTS00100 or spring terminals 170XTS00200 (to be ordered separately)                                       |                      |                     |                      |                     |                      |
| Output voltage               | 24 VDC  |                      | 120 VAC             |                      | 230 VAC             |                      |
| Number of protected channels | 16<br>(2 common pts)  | 32<br>(2 common pts) | 8<br>(2 common pts) | 16<br>(2 common pts) | 8<br>(2 common pts) | 16<br>(2 common pts) |
| Output current               | Per channel   | 0,5 A                | 0,5 A               | 2 A                  | 0,5 A               | 0,5 A                |
|                              | Per group of channels   | 4 A                  | 8 A                 | 4 A                  | 4 A                 | 4 A                  |
|                              | Per module  | 8 A                  | 16 A                | 8 A                  | 8 A                 | 8 A                  |
| Dimensions W x D x H (mm)    | 125 x 47.5 x 141.5 (with communication modules or processors)<br>144 x 70 x 141.5 (with M1/M1E processors and optional modules) |                      |                     |                      |                     |                      |
| Reference                    | 170ADO34000   | 170ADO35000          | 170ADO53050         | 170ADO54050          | 170ADO73050         | 170ADO74050          |

6



| Type of module            | Multibus discrete I/O   |                  |                   |                 |                  |                  |                           |               |  |
|---------------------------|---|------------------|-------------------|-----------------|------------------|------------------|---------------------------|---------------|--|
|                           | Solid state   |                  |                   | Relay           |                  | Triac            |                           |               |  |
| Connection                | By screw terminals 170XTS00100 or spring terminals 170XTS00200 (to be ordered separately)                                       |                  |                   |                 |                  |                  |                           |               |  |
| Number of channels        | Inputs  | 16 (1 common pt) | 16 (4 com. pts)   | 16 (1 com. pt)  | 10 (1 common pt) |                  |                           |               |  |
|                           | Input logic   | Positive         | Positive (2)      | Negative        | Positive         |                  | -                         |               |  |
|                           | Outputs   | 16 (1 common pt) | 16 (2 common pts) | 8/4 (1 com. pt) | 12               | 8 (2 common pts) |                           | 8 (1 com. pt) |  |
| Input voltage             | 12...48 VDC   | 24 VDC           |                   |                 |                  |                  | 120 VAC                   |               |  |
| Output voltage            | 12...48 VDC   | 24 VDC           |                   |                 |                  |                  | 24...230 VAC/20...115 VDC |               |  |
| Output current            | Per output  | 0,5 A            | 0,5 A             | 2 A             | 0,5 A            | 2 A              | 0,5 A                     |               |  |
|                           | Per group of channels   | -                | 4 A               | 4 A             | 4/2 A            | 8 A              | 4 A                       |               |  |
|                           | Per module  | 8 A              | 8 A               | 8 A             | 6 A              | 16 A             |                           | 4 A           |  |
| Dimensions W x D x H (mm) | 125 x 47.5 x 141.5 (with communication modules or processors)<br>144 x 70 x 141.5 (with M1/M1E processors and optional modules) |                  |                   |                 |                  |                  |                           |               |  |
| Reference                 | 170ADM85010   | 170ADM35010      | 170ADM35015       | 170ADM37010     | 170ADM39010      | 170ADM39030      | 170ARM37030               | 170ADM69051   |  |

(2) For a version with high-speed positive logic, replace 0 at the end of the reference with 1. E.g. 170ADM35010 becomes 170ADM35011

Connection accessories: See [www.schneider-electric.com](http://www.schneider-electric.com)

# Modicon Momentum \_\_\_\_\_ Distributed I/O and processors

## Analog I/O modules



| Type of module            | Multibus analog inputs  |  |  |
|---------------------------|---|--|--|
| Connection                | By screw terminals 170XTS00100 or spring terminals 170XTS00200 (to be ordered separately)                                       |  |  |
| Number of channels        | 8 isolated  | 16 with common point                             | 4 isolated   |
| Input signal              | $\pm 5\text{ V}$ , $\pm 10\text{ V}$ , $\pm 20\text{ mA}$ ,<br>1...5 V, 4...20 mA   | $\pm 5\text{ V}$ , $\pm 10\text{ V}$ , 4...20 mA | Multi-range $\pm 25\text{ mV}$ , $\pm 10\text{ mV}$<br>(1) |
| Resolution                | 14 bits + sign, 15 bits unipolar  | 12 bits + sign                                   | 15 bits + sign   |
| Dimensions W x D x H (mm) | 125 x 47.5 x 141.5 (with communication modules or processors)<br>144 x 70 x 141.5 (with M1/M1E processors and optional modules) |  |  |
| Reference                 | <b>170AAI03000</b>  | <b>170AAI14000</b>                               | <b>170AAI52040</b>   |

(1) Temperature probe: Pt 100, Pt 1000, Ni 100, Ni 1000, Thermocouple: B, E, J, K, N, R, S, T.



| Type of module            | Multibus analog outputs   |                               | Analog I/O and multibus discrete I/O  |                      |                                     |                    |
|---------------------------|---|-------------------------------|---|----------------------|-------------------------------------|--------------------|
| Connection                | By screw terminals 170XTS00100 or spring terminals 170XTS00200 (to be ordered separately)                                       |                               |   |                      |                                     |                    |
| Number of channels        | Inputs  | –                             | 4 differential + 4 discrete   |                      | 6 with com pt + 8 discrete (24 VDC) |                    |
|                           | Outputs   | 4                             | 2+2 discrete (24VDC)  | 2+2 discrete (12VDC) | 4 with com pt + 8 discrete (24 VDC) |                    |
| Input signal              | $\pm 10\text{ V}$ , 0...20 mA   | $\pm 10\text{ V}$ , 4...20 mA | $\pm 5\text{ V}$ , $\pm 10\text{ V}$ , $\pm 20\text{ mA}$ ,<br>1...5 V, 4...20 mA | 0...10 V             | $\pm 10\text{ V}$                   |                    |
| Output signal             | –   |                               | $\pm 10\text{ V}$ , 4...20 mA   | 0...10 V             | $\pm 10\text{ V}$                   |                    |
| Resolution                | 12 bits + sign  |                               | 12...14 bits dep. on signal   | 14 bits              | 14 bits                             |                    |
| Dimensions W x D x H (mm) | 125 x 47.5 x 141.5 (with communication modules or processors)<br>144 x 70 x 141.5 (with M1/M1E processors and optional modules) |                               |   |                      |                                     |                    |
| Reference                 | <b>170AAO12000</b>  | <b>170AAO92100</b>            | <b>170AMM09000</b>  | <b>170AMM09001</b>   | <b>170ANR12090</b>                  | <b>170ANR12091</b> |

## Application-specific I/O modules



| Type of module            | High-speed counter   | Discrete I/O with Modbus port |
|---------------------------|--|-------------------------------|
| Connection                | By screw terminals 170XTS00100 or spring terminals 170XTS00200 (to be ordered separately)  |                               |
| Type of inputs for        | Incremental or absolute encoders   | RS 485 Modbus port            |
| Operating voltage         | 24 VDC   | 120 VAC                       |
| Counting frequency        | 200 kHz  | –                             |
| Number of channels        | 2 independent  | –                             |
| Number of discrete I/O    | 2 x 3 inputs/2 x 2 outputs   | 6 inputs/3 outputs            |
| Dimensions W x D x H (mm) | 125 x 47.5 x 141.5 (with communication modules or M1/M1E processors)<br>144 x 70 x 141.5 (with M1/M1E processors and optional modules) |                               |
| Reference                 | <b>170AEC92000</b>   | <b>170ADM54080</b>            |



# Modicon Momentum \_\_\_\_\_ Distributed I/O and processors

## Communication modules



| Type of module    | Ethernet TCP/IP network |             | Fipio fieldbus | INTERBUS (1) fieldbus | Profibus DP fieldbus |
|-------------------|-------------------------|-------------|----------------|-----------------------|----------------------|
| Speed             | 10 Mbps                 | 10/100 Mbps | 1 Mbps         | 0.5 Mbps              | 9.6 K...12 Mbps      |
| Manager PLC       | -                       |             | Premium        | -                     | -                    |
| Redundancy        | No                      |             | No             | No                    | No                   |
| Standard services | Modbus TCP/IP           |             | -              | -                     | -                    |
| Reference         | 170ENT11002             | 170ENT11001 | 170FNT11001    | 170INT11000 (1)       | 170DNT11000          |

(1) Generation 4, twisted pair medium: 170INT11003, with optical fiber medium: 170INT12000



| Type of module    | Other networks Modbus Plus |             | DeviceNet   |
|-------------------|----------------------------|-------------|-------------|
| Speed             | 1 Mbps                     |             | 0.5 Mbps    |
| Manager PLC       | Premium or Quantum         | Quantum     | -           |
| Redundancy        | No                         | Yes         | No          |
| Standard services | -                          |             | -           |
| Reference         | 170PNT11020                | 170PNT16020 | 170LNT71000 |

## Optional modules for M1/M1E processors



| Type of module (2)  | Modbus Plus                       |                         | Asynchronous serial link |
|---------------------|-----------------------------------|-------------------------|--------------------------|
| Communication ports | 1 Modbus Plus                     | 2 redundant Modbus Plus | RJ45                     |
| Real-time clock     | Integrated, ± 13 sec/day accuracy |                         |                          |
| Connection          | By 9-way SUB-D connector          |                         |                          |
| Reference           | 172PNN21022                       | 172PNN26022             | 172JNN21032              |

(2) Include save battery of the M1/M1E processors application and data memories.

## Connection accessories

| Type      | RS 232C communication cable |             |             |
|-----------|-----------------------------|-------------|-------------|
| Length    | 1 m                         | 3 m         | 6 m         |
| Reference | 110XCA28201                 | 110XCA28202 | 110XCA28203 |

## Power supply module (3)



| Type of power supply module for | Momentum processors                 |
|---------------------------------|-------------------------------------|
| Input voltage                   | 120 or 230 VAC (selected by jumper) |
| Output voltage                  | 24 VDC                              |
| Output current                  | 0.7 A                               |
| Dimensions W x D x H (mm)       | 73 x 44.5 x 146                     |
| Reference                       | 170CPS11100                         |

(3) Process power supplies see chapter 6 "Power supply"

# Modicon Momentum \_\_\_\_\_ Distributed I/O and processors

## M1/M1E processors



| Type of processor              |                           | M1                 |                      |                    |                      |
|--------------------------------|---------------------------|--------------------|----------------------|--------------------|----------------------|
| Number of I/O                  | Discrete                  | 2048 I/O           |                      | 2048 I/2048 Q      |                      |
|                                | Registers                 | 2048 words         |                      | 4096 words         |                      |
| Integrated communication ports | Modbus                    | 1 RS 232C          | 1 RS 232C + 1 RS 485 |                    | 1 RS 232C + 1 RS 485 |
|                                | Ethernet TCP/IP           | –                  |                      |                    |                      |
|                                | I/O bus (1)               | –                  |                      | 1 I/O port         | –                    |
| Transparent Ready              | Embedded Web server       | –                  |                      |                    |                      |
| Memory capacity                | RAM                       | 64 Kb              |                      | 256 Kb             |                      |
|                                | Flash                     | 256 Kb             |                      | 256 Kb             |                      |
|                                | User, 984 LL language (2) | 2.4 K              |                      | 12 K               |                      |
|                                | User, IEC language (3)    | –                  |                      | 160 K              |                      |
|                                | Data                      | 2 K                |                      | 4 K                |                      |
| Cycle time                     |                           | 1 ms/K             | 1 ms/K               | 0.63 ms/K          | 1 ms/K               |
| Reference                      |                           | <b>171CCS70000</b> | <b>171CCS78000</b>   | <b>171CCS76000</b> | <b>171CCC78010</b>   |

(1) I/O bus derived from INTERBUS bus.

(2) ProWORX 32 or Concept programming software.

(3) Concept programming software.



| Type of processor              |                           | M1                 | M1E                |                               |                    |
|--------------------------------|---------------------------|--------------------|--------------------|-------------------------------|--------------------|
| Number of I/O                  | Discrete                  | 8192 I/O           |                    |                               |                    |
|                                | Registers                 | 26048 words        |                    |                               |                    |
| Integrated communication ports | Modbus                    | 1 RS 232C          | 1 RS 485           |                               | –                  |
|                                | Ethernet TCP/IP           | –                  |                    | 1 integrated Ethernet port    |                    |
|                                | I/O bus (1)               | 1 I/O port         | –                  |                               | 1 I/O port         |
| Transparent Ready              | Embedded Web server       | –                  |                    | Standard services (class A10) |                    |
| Memory capacity                | RAM                       | 512 Kb             |                    | 544 Kb                        |                    |
|                                | Flash                     | 512 Kb             |                    | 1 Mb                          | 512 Kb             |
|                                | User, 984 LL language (2) | 18 K               |                    |                               |                    |
|                                | User, IEC language (3)    | 240 K              | –                  | 200 K                         | –                  |
|                                | Data                      | 24 K               |                    |                               |                    |
| Cycle time                     |                           | 1 ms/K             | 0.3 ms/K           |                               |                    |
| Reference                      |                           | <b>171CCC76010</b> | <b>171CCC98020</b> | <b>171CCC98030</b>            | <b>171CCC96020</b> |
|                                |                           |                    |                    | <b>171CCC96030</b>            |                    |



| Type of processor              |                           | 171 CBB97030                |
|--------------------------------|---------------------------|-----------------------------|
| Integrated communication ports | Modbus                    | 1 RS 232/485                |
|                                | Ethernet TCP/IP           | 4 integrated Ethernet port  |
| Transparent Ready              | Embedded Web server       | Standard services (class B) |
| Memory capacity                | RAM                       | 512 Kb                      |
|                                | Flash                     | 1 Mb                        |
|                                | User, 984 LL language (2) | 18 K                        |
|                                | User, IEC language (3)    | 200 K                       |
|                                | Data                      | 24 K                        |
| Cycle time                     |                           | 0.25 ms/K                   |
| Reference                      |                           | <b>171CBB97030</b>          |

Connection accessories: See [www.schneider-electric.com](http://www.schneider-electric.com)



| Type of connection sub-base   | Optimum         |                 |            |            |
|---|-----------------|-----------------|------------|------------|
| Number of channels  | 16              | 16              |            |            |
| Max. current per channel  | 0.5 A           | 0.5 A           |            |            |
| Control voltage / output voltage  | 24 VDC / 24 VDC | 24 VDC / 24 VDC |            |            |
| LED per channel   | –               | With            |            |            |
| Number of terminals per channel/on row number                                     | 1/2             | 1/1             | 2/2        | 3/3        |
| Dimensions W x D x H (mm)   | 55 x 59 x 67    | 106 x 60 x 49   |            |            |
| References  | –               | ABE7H16C11      | ABE7H16C21 | ABE7H16C31 |
| Cable L = 1 m   | ABE7H20E100 (1) | –               | –          | –          |
| Cable L = 2 m   | ABE7H20E200 (1) | –               | –          | –          |
| Cable L = 3 m   | ABE7H20E300 (1) | –               | –          | –          |
| Connection cable recommended for Modicon, TSX Micro and Premium PLCs, L = 1 m (2) | ABFH20H100      |                 |            |            |

(1) Connection cable supplied for PLCs.

(2) For a 2 m length cable, replace the number 1 in the reference by 2, and for a 3 m length, by 3. (Example: ABFH20H100 becomes ABFH20H200).



| Type of connection sub-base   | Universal       |            |              |               |            |            |
|---|-----------------|------------|--------------|---------------|------------|------------|
| Number of channels  | 16              |            |              |               |            |            |
| Max. current per channel  | 0.5 A           |            |              |               |            |            |
| Control voltage / output voltage  | 24 VDC / 24 VDC |            |              |               |            |            |
| LED per channel   | –               | With       | –            | –             | With       | With       |
| Number of terminals per channel/on row number   | 1/1             | 1/1        | 1/2          | 2/2           | 2/2        | 3/3        |
| Dimensions W x D x H (mm)   | 125 x 58 x 70   |            | 84 x 58 x 70 | 125 x 58 x 70 |            |            |
| References  | ABE7H16R10      | ABE7H16R11 | ABE7H16R50   | ABE7H16R20    | ABE7H16R21 | ABE7H16R31 |
| Connection cable recommended for Modicon, TSX Micro and Premium PLCs, L = 1 m: ABFH20H100 (2) |                 |            |              |               |            |            |

(2) For a 2 m length cable, replace the number 1 in the reference by 2, and for a 3 m length, by 3. (Example: ABFH20H100 becomes ABFH20H200).



| Type of connection sub-base                       | For counter and analogue channels      | Passive distribution with shielding continuity | Distribution and supply of analogue channels |
|---|--|--|--|
| Number of channels                                | 1 counter channel (3)                  | 8  | 8  |
| Max. current per channel                          | 25 mA                                  | 25 mA  | 25 mA  |
| Control voltage / output voltage                  | 24 VDC / 24 VDC                        |  |  |
| Number of terminals per channel                   | 2                                      | 2 or 4   | 2 or 4                                       |
| Dimensions W x D x H (mm)                         | 143 x 58 x 70                          | 125 x 58 x 70                                  | 125 x 58 x 70                                |
| References  | ABE7CPA01                              | ABE7CPA02                                      | ABE7CPA03                                    |
| Connection cable recommended for Modicon PLCs (4) | TSX Micro L = 2.5 m<br>Premium L = 3 m | TSXCCPS15                                      | –  |
|   |  | TSXCAP030                                      | –  |

(3) Or 8 inputs + 2 outputs, analogue .

(4) Connection cables available for other PLCs, please refer to your Schneider Electric agency.



| Type of connection sub-base     | With soldered solid-state relay inputs  | With soldered solid-state relay outputs    | With soldered electro-mechanical relay outputs |
|---------------------------------|---|--|--|
| Number of channels              | 16                                      | 16   | 16   |
| Max. current per channel        | 12 mA                                   | 0.5 A                                      | 2 A   5 A                                      |
| Input voltage / output voltage  | 24 VDC / -   110 VAC / -                | - / 24 VDC                                 | - / 5...30 VDC, 250 VAC                        |
| Number of contacts              | -                                       | -  | 1 N/O  |
| Polarity distribution           | -                                       | -  | (1)   Volt-free                                |
| Number of terminals per channel | 2                                       |  |  |
| Dimensions W x D x H (mm)       | 206 x 58 x 77                           |  |  |
| References                      | <b>ABE7S16E2B1</b>   <b>ABE7S16E2F0</b> | <b>ABE7S16S2B0(2)</b>   <b>ABE7S16S1B2</b> | <b>ABE7R16S111</b>   <b>ABE7R16S210</b>        |

Connection cable recommended for Modicon, TSX Micro and Premium PLCs, L = 1 m: **ABFH20H100** (3)

(1) Contact common per group of 8 channels.

(2) With fault detection signal (can only be used with modules with protected outputs).

(3) For a 2 m length cable, replace the number 1 in the reference by 2, and for a 3 m length, by 3. (Example: ABFH20H100 becomes ABFH20H200).



| Type of connection sub-base      | With plug-in electromechanical relays |                    |                    |                    |   |
|----------------------------------|---------------------------------------|--------------------|--------------------|--------------------|---|
| Number of channels               | 16                                    |                    |                    |                    |   |
| Max. current per channel         | 5 A                                   | 2.5 A              |                    | 4 A                | 5 A                                     |
| Control voltage / output voltage | 24 VDC / 5...24 VDC, 230 VAC          |                    |                    |                    |   |
| Number of contacts               | 1 N/O                                 |                    | 1 C/O              |                    | 2 C/O                                   |
| Polarity distribution            | (4)                                   | (5)                | Volt-free          |                    |   |
| Number of terminals per channel  | 2                                     | 2 or 3             |                    | 2 to 6             |   |
| Dimensions W x D x H (mm)        | 110 x 54 x 89                         | 211 x 64 x 89      |                    | 272 x 74 x 89      |   |
| References                       | <b>ABE7R16T111</b>                    | <b>ABE7R16T212</b> | <b>ABE7R16T210</b> | <b>ABE7R16T230</b> | <b>ABE7R16T330</b>   <b>ABE7R16T370</b> |

Connection cable recommended for Modicon, TSX Micro and Premium PLCs, L = 1 m: **ABFH20H100** (6)

(4) Contact common per group of 4 channels.

(5) Common on both poles.

(6) For a 2 m length cable, replace the number 1 in the reference by 2, and for a 3 m length, by 3. (Example: ABFH20H100 becomes ABFH20H200).

### Connection cables for PLCs (7)

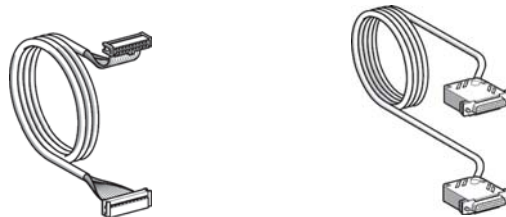

| Input/Output functions | Discrete          | Analogue          | Analogue and counter | Counter          | Axis control     |
|------------------------|-------------------|-------------------|----------------------|------------------|------------------|
| References             |                   |                   |                      |                  |                  |
| Cable L = 1 m          | <b>ABFH20H100</b> | -                 | -                    | -                | -                |
| Cable L = 2 m          | <b>ABFH20H200</b> | <b>ABFY25S200</b> | -                    | -                | <b>TSXCXP213</b> |
| Cable L = 2.5 m        | -                 | -                 | <b>TSXCCPS15</b>     | <b>TSXCCPH15</b> | -                |
| Cable L = 3 m          | <b>ABFH20H300</b> | <b>TSXCAP030</b>  | -                    | -                | -                |
| Cable L = 6 m          | -                 | -                 | -                    | -                | <b>TSXCXP613</b> |

(7) Modicon, TSX Micro and Premium PLCs.

For other connection cables and accessories, please refer to your Schneider Electric agency.



| Type of connection sub-base                | Discrete outputs                   |                                    |  | Relay                             |
|--|------------------------------------|------------------------------------|--|-----------------------------------|
|  | Number of channels                 | 16                                 | 16   | 16                                |
| Type of outputs                            | 16 I<br>(1 common for 16 channels) | 16 O<br>(1 common for 16 channels) | 16 O, fuse protected<br>(1 common for 16 channels) | 16 O<br>(1 common for 4 channels) |
| Voltage / current of outputs               | 24 VDC / 5 mA                      | 24 VDC / 0.1 A                     |  | Relay: 5...30 VDC, 250 VAC / 3 A  |
| LED per channel                            | –                                  |                                    | With   | –                                 |
| Number of terminals per channel/row number | 2/2                                |                                    |  |                                   |
| Dimensions W x D x H (mm)                  | 106 x 60 x 49                      |                                    | 130 x 62.5 x 83                                    |                                   |
| References                                 | <b>ABE7E16EPN20</b>                | <b>ABE7E16SPN20</b>                | <b>ABE7E16SPN22</b>                                | <b>ABE7E16SRM20</b>               |

## Connection cables for Twido and Modicon M238



| Type of cable      | For linking Twido base and Modicon Telefast sub-base        | For linking discrete I/O expansion modules Twido or Modicon M238 and Modicon Telefast sub-base |
|--------------------|---|--|
| For use with       | TWDLMDA20DTK/40DTK  | TM2DI16DK/32DK/DDO16TK/32TK  |
| Type of connectors | HE10, 26-pin, at either end                                 | HE10, 20-pin, at either end  |
| References         | Cable<br>L = 0.5 m<br>L = 1 m<br>L = 2 m                    |  |
|                    | <b>ABFT26B050</b><br><b>ABFT26B100</b><br><b>ABFT26B200</b> | <b>ABFT20E050</b><br><b>ABFT20E100</b><br><b>ABFT20E200</b>                                    |

6

## Accessories

| Type of accessory          | Optional clip-in terminals |                   |
|----------------------------|----------------------------|-------------------|
| Number of linked terminals | 20                         | 12 + 8            |
| References                 | <b>ABE7BV20</b>            | <b>ABE7BV20TB</b> |



| Type of connection            |               | To PLC using multicore cable |                   |              |
|-------------------------------|---------------|------------------------------|-------------------|--------------|
| Number of channels            |               | 4                            | 8                 |              |
| Type of female connector      |               | M12, 5-pin                   | M12, 5-pin        |              |
| Max. number of signals        |               | 8                            | 16                |              |
| Max. current per channel      |               | 4 A                          |                   |              |
| Max. current per splitter box |               | 16 A (1 mm <sup>2</sup> )    |                   |              |
| Product certification         |               | cULus                        |                   |              |
| Dimensions W x D x H (mm)     |               | 50.2 x 42 x 92.2             | 50.2 x 42 x 149.2 |              |
| References                    | Without LEDs  | Cable L = 5 m                | ABE9C1240L05      | ABE9C1280L05 |
|                               |               | Cable L = 10 m               | ABE9C1240L10      | ABE9C1280L10 |
|                               | With LEDs (1) | Cable L = 5 m                | ABE9C1241L05      | ABE9C1281L05 |
|                               |               | Cable L = 10 m               | ABE9C1241L10      | ABE9C1281L10 |

(1) Green LED: power supply status, yellow LED: channel status.



| Type of connection            |               | To PLC using M23 connector |                     |
|-------------------------------|---------------|----------------------------|---------------------|
| Number of channels            |               | 4                          | 8                   |
| Type of female connector      |               | M12, 5-pin                 | M12, 5-pin          |
| Max. number of signals        |               | 8                          | 16                  |
| Max. current per channel      |               | 4 A                        |                     |
| Max. current per splitter box |               | 16 A                       |                     |
| Product certification         |               | cULus                      |                     |
| Dimensions, W X D x H         |               | 50.2 x 36.5 x 92.2         | 50.2 x 36.5 x 149.2 |
| References                    | Without LEDs  | ABE9C1240C23               | ABE9C1280C23        |
|                               | With LEDs (1) | ABE9C1241C23               | ABE9C1281C23        |

(1) Green LED: power supply status, yellow LED: channel status.

## Accessories

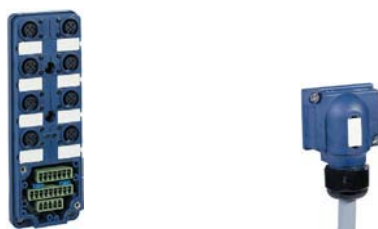

| Type of accessory |                   | Splitter boxes w/o cable |            | Terminal connectors |                | Sealing plugs<br>(sold in lots of 10) |
|-------------------|-------------------|--------------------------|------------|---------------------|----------------|---------------------------------------|
|                   |                   | Without LEDs             | With LEDs  | Cable L = 5 m       | Cable L = 10 m |                                       |
| References        | 4-channel         | ABE9C1240M               | ABE9C1241M | ABE9XCA1405         | ABE9XCA1410    | –                                     |
|                   | 8-channel         | ABE9C1280M               | ABE9C1281M | ABE9XCA1805         | ABE9XCA1810    | –                                     |
|                   | for Ø12 connector | –                        | –          | –                   | –              | FTXCM12B                              |

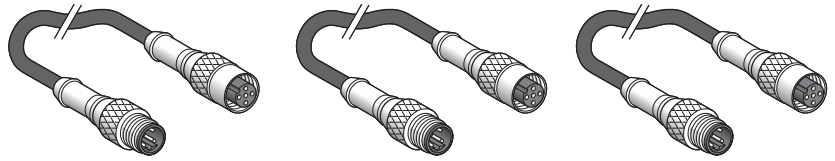

| Type                                   |       |         | Male / Female jumper cables        |                                    |                                    |
|--|-------|---------|------------------------------------|------------------------------------|------------------------------------|
| Type of male connector, interface side |       |         | M12, 4-pin, straight, screw thread | M12, 4-pin, straight, screw thread | M12, 5-pin, straight, screw thread |
| Type of female connector, sensor side  |       |         | M12, 3-pin, straight, screw thread | M12, 4-pin, straight, screw thread | M12, 5-pin, straight, screw thread |
| Cable                                  |       |         | PUR, black                         | PUR, black                         | PUR, black                         |
| <b>References</b>                      | Cable | L = 1 m | <b>XZCR1511040A1</b>               | <b>XZCR1511041C1</b>               | <b>XZCR1511064D1</b>               |
|  |       | L = 2 m | <b>XZCR1511040A2</b>               | <b>XZCR1511041C2</b>               | <b>XZCR1511064D2</b>               |

**M8/M8, M8/M12 and M12/DIN jumper cables**

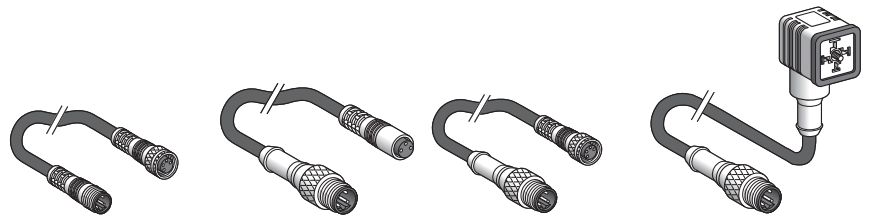

| Type                                   |       |         | Male / Female jumper cables      |                                   |                                   |                                   |
|--|-------|---------|----------------------------------|-----------------------------------|-----------------------------------|-----------------------------------|
| Type of male connector, interface side |       |         | M8, 3-pin straight, screw thread | M12, 3-pin straight, screw thread | M12, 3-pin straight, screw thread | M12, 3-pin straight, screw thread |
| Type of female connector, sensor side  |       |         | M8, 3-pin straight, screw thread | M8, 3-pin straight, clip together | M8, 3-pin straight, screw thread  | DIN 43650A elbowed, screw thread  |
| Cable                                  |       |         | PUR, black                       | PUR, black                        | PUR, black                        | PUR, black                        |
| <b>References</b>                      | Cable | L = 1 m | <b>XZCR2705037R1</b>             | <b>XZCR1501040G1</b>              | <b>XZCR1509040H1</b>              | <b>XZCR1523062K1</b>              |
|  |       | L = 2 m | <b>XZCR2705037R2</b>             | <b>XZCR1501040G2</b>              | <b>XZCR1509040H2</b>              | <b>XZCR1523062K2</b>              |

**6**

**Pre-wired connectors and splitter box**

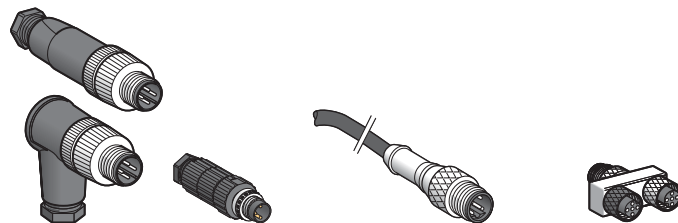

| Type                                   |                                  |                                 | Connectors          |                    | Pre-wired connectors               | Splitter box "Y" |                  |
|--|----------------------------------|---------------------------------|---------------------|--------------------|------------------------------------|------------------|------------------|
| Type of male connector, interface side |                                  |                                 | M12, 4-pin          | M8, 3-pin          | M12, 5-pin, straight, screw thread | 1 x M12          | 1 x M12          |
| Type of female connector, sensor side  |                                  |                                 | -                   | -                  | -                                  | 2 x M12          | 2 x M8           |
| Cable                                  |                                  |                                 | -                   | -                  | PUR, black                         | -                | -                |
| <b>References</b>                      | Straight connector, screw thread |                                 | <b>XZCC12MDM40B</b> | <b>XZCC8MDM30V</b> | -                                  | <b>FTXCY1212</b> | <b>FTXCY1208</b> |
|  |                                  | Elbowed connector, screw thread | <b>XZCC12MCM40B</b> | -                  | -                                  | -                | -                |
|  | Cable                            | L = 0.5 m                       | -                   | -                  | <b>XZCP1564L05</b>                 | -                | -                |
|  |                                  | L = 2 m                         | -                   | -                  | <b>XZCP1564L2</b>                  | -                | -                |

# Modicon FactoryCast

Modicon FactoryCast PLC modules and the Modicon FactoryCast Gateway combine the benefits of open Web technologies with the reliability of industrial control.

In the areas of distributed infrastructure, RTU installations, industry, machinery and energy, the Modicon FactoryCast ranges offer an ideal solution for all your remote diagnostics and maintenance, monitoring, control and programming needs.



Schneider Electric's communication solutions for industrial networks monitor your control system applications to give you precise control and maintenance data in real time.

Remote intelligent modules or in-rack modules for PLCs, standalone products and devices - the Modicon FactoryCast, AS-Interface and Modicon Connexium ranges provide access to advanced functions, flexible tools and services for optimising communication between all your automation products.



## AS-Interface

AS-Interface is a quick expandable cabling system which connects all components in a control system with just a single cable. Intelligent, it features built-in communication management.



## Modicon Connexium

Designed for open industrial solutions, Modicon Connexium products are the Ethernet-ready network hubs, switches, transceivers, gateways and cables which provide you with integrated Ethernet solutions to unite everything in your installation, from device level all the way to your corporate intranet. Modicon Connexium boosts network performance and reliability.



# 7 | Networks connectivity and Web servers



## ConneXium cabling system

|                             |            |
|-----------------------------|------------|
| Hub, IP 67 Switch .....     | 7/2        |
| Switches .....              | 7/3 to 7/7 |
| Gateways & Converters ..... | 7/8        |
| Cables & Connectors .....   | 7/9        |
| WiFi products .....         | 7/10       |

## AS-Interface cabling system

|  |              |
|--|--------------|
| <b>Modicon interfaces for generic products</b> ..... | 7/12 to 7/13 |
| IP20 interfaces                                      |              |
| IP67 interfaces                                      |              |
| <b>Dedicated components</b> .....                    | 7/14 to 7/15 |
| For control  |              |
| For dialogue   |              |
| <b>Installation system</b> .....                     | 7/16 to 7/18 |
| Master modules, power supply units                   |              |
| Cables, repeaters                                    |              |
| Accessories  |              |
| <b>Tools</b> .....                                   | 7/19         |
| Adjustment and addressing terminals                  |              |
| <br><b>Safety solutions</b>                          |              |
| Safety monitors                                      |              |
| Safety interfaces                                    |              |
| see Chapter 8 “Machine safety”                       |              |

## Servers and Gateways

|                                 |              |
|---------------------------------|--------------|
| Data server software,           |              |
| <b>OPC Factory Server</b> ..... | 7/20         |
| Others server and gateways,     |              |
| <b>FactoryCast</b> .....        | 7/21 to 7/23 |



| Hub                            |                    |   |  |
|--------------------------------|--------------------|---|--|
| <b>Interfaces</b>              | Copper cable ports | Number and type   | 4 x 10BASE-T ports                     |
|                                |                    | Shielded connectors   | RJ45                                   |
|                                |                    | Medium  | Shielded twisted pair, category CAT 5E |
|                                |                    | Total length of pair  | 100 m                                  |
| <b>Power supply</b>            | Voltage            | 24 V (18...32) DC, safety extra low voltage (SELV)                            |  |
| <b>Degree of protection</b>    |                    | IP 30   |  |
| <b>Dimensions W x H x D</b>    |                    | 40 x 125 x 80 mm  |  |
| <b>Conformity to standards</b> |                    | cUL 60950, UL 508 and CSA 142, UL 1604 and CSA 213 Class 1 Division 2, C€, GL |  |
|                                |                    | FM 3810, FM 3611 Class 1 Division 2 , C-TICK                                  |  |
| <b>Reference</b>               |                    | <b>499 NEH 104 10</b>   |  |



| IP 67 switch                   |                    | Twisted pair, unmanaged                               |  |
|--------------------------------|--------------------|---|--|
| <b>Interfaces</b>              | Copper cable ports | Number and type                                       | 5 x 10BASE-T/100BASE-TX ports          |
|                                |                    | Shielded connectors                                   | M12 (type D)                           |
|                                |                    | Medium  | Shielded twisted pair, category CAT 5E |
|                                |                    | Total length of pair                                  | 100 m with rated cable                 |
| <b>Power supply</b>            | Voltage            | 24 VDC (18...32 VDC), safety extra low voltage (SELV) |  |
| <b>Degree of protection</b>    |                    | IP 65/67  |  |
| <b>Dimensions W x H x D</b>    |                    | 60 x 126 x 31 mm                                      |  |
| <b>Conformity to standards</b> |                    | cUL 508 and CSA 22.2 14 , C-TICK                      |  |
| <b>Reference</b>               |                    | <b>TCS ESU 051 F0</b>                                 |  |



| Switches                       |  |  | Copper twisted pair, unmanaged         |                                |                                |                                |
|--------------------------------|--|--|--|--------------------------------|--------------------------------|--------------------------------|
| <b>Interfaces</b>              | Copper cable ports                       | Number and type  | 3 x 10BASE-T/ 100BASE-TX ports         | 4 x 10BASE-T/ 100BASE-TX ports | 5 x 10BASE-T/ 100BASE-TX ports | 8 x 10BASE-T/ 100BASE-TX ports |
|                                |  | Shielded connectors  | Type RJ45                              |                                |                                |                                |
|                                |  | Medium   | Shielded twisted pair, category CAT 5E |                                |                                |                                |
|                                |  | Total length of pair   | 100 m                                  |                                |                                |                                |
|                                | Fiber optic ports                        | Number and type  | –                                      | 1 x 100BASE-FX ports           | –                              | –                              |
|                                |  | Connectors   | –                                      | Duplex SC                      | –                              | –                              |
|                                |  | Medium   | –                                      | Multimode optical fiber        | –                              | –                              |
|                                |  | Length of optical fiber  |  |                                |                                |                                |
|                                |  | 50/125 µm fiber  | –                                      | 5000 m (1)                     | –                              | –                              |
|                                |  | 62,2/125 µm fiber  | –                                      | 4000 m (1)                     | –                              | –                              |
| Attenuation analys             | 50/125 µm fiber                          | –  | 8 dB                                   | –                              | –                              |                                |
|                                | 62,2/125 µm fiber                        | –  | 11 dB                                  | –                              | –                              |                                |
| <b>Power supply</b>            | Voltage, safety extra low voltage (SELV) | ~ 24 VDC (~ 9,6...32 VDC)  |  |                                |                                |                                |
|                                | Power consumption                        | Max. 2,2 W   | Max. 3,9 W                             | Max. 2,2 W                     | Max. 4,1 W                     |                                |
|                                | Connector                                | 3 way removable connector  |  |                                |                                |                                |
| <b>Degree of protection</b>    |  | IP 30  |  |                                |                                |                                |
| <b>Dimensions</b>              |  | W x H x D  | 25 x 114 x 79 mm                       |                                |                                | 35 x 138 x 121 mm              |
| <b>Weight</b>                  |  |  | 0,113 kg                               | 0,120 kg                       | 0,113 kg                       | 0,246 kg                       |
| <b>Conformity to standards</b> |  | UL 508 and CSA 22.2 N° 142<br>IEC/EN 61131-2, IEC 60825-1 class 1, CISPR 11A |  |                                |                                |                                |
| <b>Alarm relay</b>             |  | –  |  |                                |                                |                                |
| <b>Reference</b>               |  | <b>TCS ESU 033FN0</b>  | <b>TCS ESU 043F1N0</b>                 | <b>TCS ESU 053FN0</b>          | <b>TCS ESU 083FN0</b>          |                                |

(1) Length dependent on the attenuation analysis and attenuation of the fiber optic (typical value: 2,000 m).



| Switches                       |                    |  | Copper twisted pair and fibre optic, unmanaged |                                |                                |                                |                                |
|--------------------------------|--------------------|--|--|--------------------------------|--------------------------------|--------------------------------|--------------------------------|
| <b>Interfaces</b>              | Copper cable ports | Number and type  | 4 x 10BASE-T/ 100BASE-TX ports                 | 3 x 10BASE-T/ 100BASE-TX ports | 4 x 10BASE-T/ 100BASE-TX ports | 3 x 10BASE-T/ 100BASE-TX ports | 8 x 10BASE-T/ 100BASE-TX ports |
|                                |                    | Shielded connectors  | RJ45   |                                |                                |                                |                                |
|                                |                    | Medium   | Shielded twisted pair, category CAT 5E         |                                |                                |                                |                                |
|                                |                    | Total length of pair   | 100 m  |                                |                                |                                |                                |
|                                | Fiber optic ports  | Number and type  | 1 x 100BASE-FX port                            | 2 x 100BASE-FX ports           | 1 x 100BASE-FX port            | 2 x 100BASE-FX ports           | –                              |
|                                |                    | Connectors   | SC   |                                |                                |                                | –                              |
|                                |                    | Medium   | Multimode optical fiber                        |                                | Single mode optical fiber      |                                | –                              |
|                                |                    | Length of optical fiber  |  |                                |                                |                                |                                |
|                                |                    | 50/125 µm fiber  | 5000 m (1)                                     |                                |                                |                                | –                              |
|                                |                    | 62,2/125 µm fiber  | 4000 m (1)                                     |                                |                                |                                | –                              |
|                                | 9/125 µm fiber     | –  |  | 32 500 m (2)                   |                                | –                              |                                |
| <b>Power supply</b>            | Voltage            | 24 VDC (18...32), safety extra low voltage (SELV)                                      |  |                                |                                |                                |                                |
| <b>Degree of protection</b>    |                    | IP 20  |  |                                |                                |                                |                                |
| <b>Dimensions</b>              |                    | W x H x D  | 47 x 135 x 111 mm                              |                                |                                |                                |                                |
| <b>Conformity to standards</b> |                    | cUL 60950, cUL 508 and CSA 142, UL 1604 and CSA 213 Class 1 Division 2, CE, GL, C-TICK |  |                                |                                |                                |                                |
| <b>References</b>              |                    | <b>499 NMS 251 01</b>  | <b>499 NMS 251 02</b>                          | <b>499 NSS 251 01</b>          | <b>499 NSS 251 02</b>          | <b>499 NES 181 00</b>          |                                |

(1) Length dependent on the attenuation analysis and attenuation of the fiber optic (typical value: 2,000 m).

(2) Length dependent on the attenuation analysis and attenuation of the fiber optic (typical value: 15,000 m).



| Switches                       |                         |                         | Copper twisted pair and fiber optic, managed  |                           |                         |                         |
|--------------------------------|-------------------------|-------------------------|---|---------------------------|-------------------------|-------------------------|
| <b>Interfaces</b>              | Copper cable ports      | Number and type         | 3 x 10/100BASE-TX ports   | 2 x 10/100BASE-TX ports   | 3 x 10/100BASE-TX ports | 2 x 10/100BASE-TX ports |
|                                |                         | Shielded connectors     | RJ45  |                           |                         |                         |
|                                |                         | Medium                  | Shielded twisted pair, category CAT 5E  |                           |                         |                         |
|                                |                         | Total length of pair    | 100 m   |                           |                         |                         |
|                                | Fiber optic ports       | Number and type         | 1 x 100BASE-FX port   | 2 x 100BASE-FX ports      | 1 x 100BASE-FX port     | 2 x 100BASE-FX ports    |
|                                | Connectors              | Duplex SC               |   |                           |                         |                         |
|                                | Medium                  | Multimode optical fiber |   | Single mode optical fiber |                         |                         |
|                                | Length of optical fiber |                         |   |                           |                         |                         |
|                                | 50/125 µm fiber         | 5,000 m (1)             |   | –                         |                         |                         |
|                                | 62.2/125 µm fiber       | 4,000 m (1)             |   | –                         |                         |                         |
|                                | 9/125 µm fiber          | –                       |   | 32,500 m (2)              |                         |                         |
| <b>Power supply</b>            | Voltage                 | Operation               | 9.6...60 VDC/18...30 VAC, safety extra low voltage (SELV)   |                           |                         |                         |
| <b>Degree of protection</b>    |                         |                         | IP 20   |                           |                         |                         |
| <b>Dimensions W x H x D</b>    |                         |                         | 47 x 131 x 111 mm   |                           |                         |                         |
| <b>Conformity to standards</b> |                         |                         | IEC 61131-2, UL 508, UL 1604 Class 1 Division 2, CSA C22.2 14 (cUL), CSA C22.2 213 Class 1 Division 2 (cUL), CE, GL, C-TICK |                           |                         |                         |
| <b>References</b>              |                         |                         | <b>TCSESM043F1CU0</b>   | <b>TCSESM043F2CU0</b>     | <b>TCSESM043F1CS0</b>   | <b>TCSESM043F2CS0</b>   |

(1) Length dependent on the attenuation analysis and attenuation of the fiber optic (typical value: 2,000 m).

(2) Length dependent on the attenuation analysis and attenuation of the fiber optic (typical value: 15,000 m).



| Switches                       |                    |                      | Copper twisted pair, managed  |                         |
|--------------------------------|--------------------|----------------------|---|-------------------------|
| <b>Interfaces</b>              | Copper cable ports | Number and type      | 4 x 10/100BASE-TX ports   | 8 x 10/100BASE-TX ports |
|                                |                    | Shielded connectors  | RJ45  |                         |
|                                |                    | Medium               | Shielded twisted pair, category CAT 5E  |                         |
|                                |                    | Total length of pair | 100 m   |                         |
| <b>Power supply</b>            | Voltage            | Operation            | 9.6...60 VDC/18...30 VAC, safety extra low voltage (SELV)   |                         |
| <b>Degree of protection</b>    |                    |                      | IP 20   |                         |
| <b>Dimensions W x H x D</b>    |                    |                      | 47 x 131 x 111 mm   | 74 x 131 x 111 mm       |
| <b>Conformity to standards</b> |                    |                      | IEC 61131-2, UL 508, UL 1604 Class 1 Division 2, CSA C22.2 14 (cUL), CSA C22.2 213 Class 1 Division 2 (cUL), CE, GL, C-TICK |                         |
| <b>References</b>              |                    |                      | <b>TCSESM043F23F0</b>   | <b>TCSESM083F23F0</b>   |



| Switches                       |   |                      | Copper twisted pair and fiber optic, managed              |                         |                                |                        |
|--------------------------------|---|----------------------|---|-------------------------|--------------------------------|------------------------|
| <b>Interfaces</b>              | Copper cable ports  | Number and type      | 7 x 10/100BASE-TX ports                                   | 6 x 10/100BASE-TX ports | 7 x 10/100BASE-TX ports        | 6 x 10/100BASE-T ports |
|                                |   | Shielded connectors  | RJ45  |                         |                                |                        |
|                                |   | Medium               | Shielded twisted pair, category CAT 5E                    |                         |                                |                        |
|                                |   | Total length of pair | 100 m   |                         |                                |                        |
|                                | Fiber optic ports   | Number and type      | 1 x 100BASE-FX port                                       | 2 x 100BASE-FX port     | 1 x 100BASE-FX port            | 2 x 100BASE-FX port    |
|                                |   | Connectors           | Duplex SC   |                         |                                |                        |
|                                |   | Medium               | Multimode optical fiber (MM)                              |                         | Single mode optical fiber (SM) |                        |
| Length of optical fiber        |   |                      |   |                         |                                |                        |
|                                | 50/125 µm fiber   | 5,000 m (1)          | -   |                         |                                |                        |
|                                | 62.2/125 µm fiber   | 4,000 m (1)          | -   |                         |                                |                        |
|                                | 9/125 µm fiber  | -                    | 32,500 m (2)  |                         |                                |                        |
| <b>Power supply</b>            | Voltage   | Operation            | 9.6...60 VDC/18...30 VAC, safety extra low voltage (SELV) |                         |                                |                        |
| <b>Degree of protection</b>    | IP 20   |                      |   |                         |                                |                        |
| <b>Dimensions W x H x D</b>    | 74 x 131 x 111 mm   |                      |   |                         |                                |                        |
| <b>Conformity to standards</b> | IEC 61131-2, UL 508, UL 1604 Class 1 Division 2, CSA C22.2 14 (cUL), CSA C22.2 213 Class 1 Division 2 (cUL), CE, GL, C-TICK |                      |   |                         |                                |                        |
| <b>References</b>              |   |                      | <b>TCSESM083F1CU0</b>                                     | <b>TCSESM083F2CU0</b>   | <b>TCSESM083F1CS0</b>          | <b>TCSESM083F2CS0</b>  |

(1) Length dependent on the attenuation analysis and attenuation of the fiber optic (typical value: 2,000 m).

(2) Length dependent on the attenuation analysis and attenuation of the fiber optic (typical value: 15,000 m).



| Switches                       |   |                         | Copper twisted pair, managed                              | Copper twisted pair and fiber optic, managed |                         |                        |
|--------------------------------|---|-------------------------|---|--|-------------------------|------------------------|
| <b>Interfaces</b>              | Copper cable ports  | Number and type         | 16x 10/100BASE-TX ports                                   | 14x 10/100BASE-TX ports                      | 22x 10/100BASE-TX ports | 14 ports 10/100BASE-TX |
|                                |   | Shielded connectors     | RJ45  |  |                         |                        |
|                                |   | Total length of pair    | 100 m   |  |                         |                        |
|                                | Fiber optic ports   | Number and type         | -   | 2 x 100BASE-FX ports                         |                         |                        |
|                                |   | Connector               | -   | Duplex SC                                    |                         |                        |
|                                |   | Medium                  | -   | Multimode optical fiber                      |                         | Optical fiber          |
|                                |   | Length of optical fiber |   |  |                         |                        |
|                                | 50/125 µm fiber   | -                       | 5,000 m (1)   | -  |                         |                        |
|                                | 62.2/125 µm fiber   | -                       | 4,000 m (1)   | 32 500 M (2)                                 |                         |                        |
| <b>Power supply</b>            | Voltage   | Operation               | 9.6...60 VDC/18...30 VAC, safety extra low voltage (SELV) |  |                         |                        |
| <b>Degree of protection</b>    | IP 20   |                         |   |  |                         |                        |
| <b>Dimensions W x H x D</b>    | 111 x 131 x 111 mm  |                         |   |  |                         |                        |
| <b>Conformity to standards</b> | cUL 60950, UL 508 and CSA 142, UL 1604 and CSA 213 Class 1 Division 2, CE, GL, C-TICK |                         |   |  |                         |                        |
| <b>References</b>              |   |                         | <b>TCSESM163F23F0</b>                                     | <b>TCSESM163F2CU0</b>                        | <b>TCSESM243F2CU0</b>   | <b>TCSESM16F2CS0</b>   |

(1) Length dependent on the attenuation analysis and attenuation of the fiber optic (typical value: 2,000 m).



| Switches                       |   |                         | Copper twisted pair and fibre optic, managed - extended features  |                          |                           |              |
|--------------------------------|---|-------------------------|---|--------------------------|---------------------------|--------------|
| <b>Interfaces</b>              | Copper cable ports  | Number and type         | 8 x 10/100 BASE-TX ports  | 6 x 10/100 BASE-TX ports | 6 x 10/100 BASE-TX ports  |              |
|                                |   | Shielded connectors     | RJ45  |                          |                           |              |
|                                |   | Medium                  | Shielded twisted pair, category CAT 5E  |                          |                           |              |
|                                |   | Total length of pair    | 100 m   |                          |                           |              |
|                                | Fiber optic ports   | Number and type         | –   | 2 x 100BASE-FX ports     | 2 x 100BASE-FX ports      |              |
|                                |   | Connectors              | –   | Duplex SC                | Duplex SC                 |              |
|                                |   | Medium                  | –   | Multi mode optical fibre | Single mode optical fibre |              |
|                                |   | Length of optical fiber | 50/125 µm fiber   | –                        | 5,000 m (1)               | –            |
|                                |   |                         | 62.2/125 µm fiber   | –                        | 4,000 m (1)               | –            |
|                                |   |                         | 9/125 µm fiber  | –                        | –                         | 32,500 m (2) |
|                                |   | Attenuation analysis    | 50/125 µm fibre   | –                        | 8 dB                      | –            |
|                                |   |                         | 62.2/125 µm fiber   | –                        | 11 dB                     | –            |
|                                |   |                         | 9/125 µm fiber  | –                        | –                         | 16 dB        |
|                                |   | Ethernet services       | FDR, SMTP V3, SNMP client, multicast filtering for optimization of the Global Data protocol, configuration via Web access, VLAN, IGMP Snooping, RSTP (Rapid Spanning Tree Protocol), priority port, data stream control, secure port. |                          |                           |              |
| <b>Topology</b>                | Number of switches  | Cascaded                | Unlimited   |                          |                           |              |
|                                |   | Redundant in a ring     | max. 50   |                          |                           |              |
| <b>Redundancy</b>              | Redundant power supplies, redundant single ring, ring coupling  |                         |   |                          |                           |              |
| <b>Power supply</b>            | Voltage   | Operation               | 18 - 60 V safety extra low voltage (SELV)   |                          |                           |              |
|                                | Power consumption   |                         | 10 W  | 12 W                     | 12 W                      |              |
| <b>Degree of protection</b>    | IP30  |                         |   |                          |                           |              |
| <b>Dimensions W x H x D</b>    | 120 x 137 x 115 mm  |                         |   |                          |                           |              |
| <b>Conformity to standards</b> | IEC/EN 61131-2, IEC 61850-3, UL 508, UL ISA-12.12.-01 Class 1 Div 2 Group A, B, C, D, CSA 22.2 No. 142 (cUL), CSA 22.2 No. 213 Class 1 Division 2 (cUL), CE, GL, C-Tick |                         |   |                          |                           |              |
| <b>Alarm relay</b>             | Power supply fault, Ethernet network fault or communication port fault<br>(2 A max. volt-free contact at 30 VDC)  |                         |   |                          |                           |              |
| <b>References</b>              |   |                         | <b>TCSESM083F23F1</b>   | <b>TCSESM063F2CU1</b>    | <b>TCSESM063F2CS1</b>     |              |

(1) Length dependent on the attenuation analysis and attenuation of the fiber optic (typical value: 2,000 m).

(2) Length dependent on the attenuation analysis and attenuation of the fiber optic (typical value: 15,000 m).

| Switches                       |   |   | Copper twisted pair and fiber optic, managed              |                          |   | Copper twisted pair, managed                              |   |
|--------------------------------|---|---|---|--------------------------|---|---|---|
| <b>Interfaces</b>              | Copper cable ports  | Number and type   | 8 x 10/100 BASE-TX ports                                  |                          |   | 8 x 10/100 BASE-TX ports 2 x 100 BASE-TX ports (Gigabits) |   |
|                                |   | Shielded connectors   | RJ45  |                          |   |   |   |
|                                |   | Medium  | Shielded twisted pair, category CAT 5E                    |                          |   |   |   |
|                                |   | Total length of pair  | 100 m   |                          |   |   |   |
|                                | Fiber optic ports   | Number and type   | 2 x 100BASE-SX ports (1)                                  | 2 x 100BASE-LH ports (2) | 2 x 100BASE-LX ports (3)                | -   |   |
|                                |   | Connectors  | LC  |                          |   | -   |   |
|                                |   | Medium  | Multimode optical fiber                                   | Single optical fibre     | Single mode and multimode optical fiber | -   |   |
|                                |   | Length of optical fiber   | 50/125 µm fiber   | 550 m                    | -                                       | 550 m   | - |
|                                |   |   | 62.2/125 µm fiber   | 275 m                    | -                                       | 550 m   | - |
|                                |   |   | 9/125 µm fiber  | -                        | 8 - 72,000 m                            | 20,000 m  | - |
|                                |   | Attenuation analysis  | 50/125 µm fibre   | 7,5 dB                   | -                                       | 11 dB   | - |
|                                |   |   | 62.2/125 µm fiber   | 7,5 dB                   | -                                       | 11 dB   | - |
|                                |   |   | 9/125 µm fiber  | -                        | 6 - 22 dB                               | 11 dB   | - |
|                                | Ethernet services   | FDR, SMTP V3, SNMP client, multicast filtering for optimization of the Global Data protocol, configuration via Web access, VLAN, IGMP Snooping, RSTP (Rapid Scanning Tree Protocol), priority port, data stream control, secure port. |   |                          |   |   |   |
|                                | <b>Topology</b>   | Number of switches  | Cascaded  | Unlimited                |   |   |   |
| Redundant in a ring            |   |   | max. 50   |                          |   |   |   |
| <b>Redundancy</b>              | Redundant power supplies, redundant single ring, ring coupling                                  |   |   |                          |   |   |   |
| <b>Power supply</b>            | Voltage   | Operation   | 9,6...60 VDC/18...30 VAC, safety extra low voltage (SELV) |                          |   |   |   |
| <b>Degree of protection</b>    | IP20  |   |   |                          |   |   |   |
| <b>Dimensions W x H x D</b>    | 111 x 113 x 111 mm  |   |   |                          |   |   |   |
| <b>Conformity to standards</b> | cUL 60950, UL 508 and CSA 22.2, UL 1604 and CSA 213 CSA 22.2 No. 213 Class 1 Division 2, CE, GL |   |   |                          |   |   |   |
| <b>References</b>              | TCSESM103F2LG0  |   |   | TCSESM103F23G0           |   |   |   |

(1) With TCSEAAF1LFU00 fiber optic module to be ordered separately

(2) With TCSEAAF1LFH00 fiber optic module to be ordered separately

(3) With TCSEAAF1LFS00 fiber optic module to be ordered separately

| Switches          |                                |   | Copper twisted pair and fiber optic, managed   |                       |                | Copper twisted pair, managed |   |
|-------------------|--------------------------------|---|--|-----------------------|----------------|------------------------------|---|
| <b>Interfaces</b> | Copper cable ports             | Number and type                             | 6 x 10/100 BASE-TX ports   |                       |                | 8 x 10/100 BASE-TX ports     |   |
|                   |                                | Shielded connectors                         | RJ45   |                       |                |                              |   |
|                   |                                | Total length of pair                        | 100 m  |                       |                |                              |   |
|                   | Fiber optic ports              | Number and type                             | 2 x 100 BASE-SX ports  | 3 x 100 BASE-LX ports |                | -                            |   |
|                   |                                | Connector                                   | Duplex SC  |                       |                | -                            |   |
|                   |                                | Medium                                      | Multimode optical fiber  |                       |                | -                            |   |
|                   |                                | Length of optical fiber                     | 50/125 µm fiber  | 5,000 m (1)           |                | -                            |   |
|                   |                                |   | 62.2/125 µm fiber  | 4,000 m (1)           |                | -                            |   |
|                   |                                |   | Attenuation analysis   | 50/125 µm fiber       | 8 dB           |                              | - |
|                   |                                | 62.2/125 µm fiber                           |  | 11 dB                 |                | -                            |   |
|                   |                                | Ethernet services                           | FDR, SNMP client, multicast filtering for optimization of the Global Data protocol, configuration via Web access, IGMP Snooping, RSTP (Rapid Scanning Tree Protocol), priority port, data stream control, secure port. |                       |                |                              |   |
|                   |                                | <b>Topology</b>                             | Number of switches   | Cascaded              | Unlimited      |                              |   |
|                   | Redundant in a ring            |   |  | Max. 50               |                |                              |   |
|                   | <b>Redundancy</b>              | Redundant power supplies                    |  |                       |                |                              |   |
|                   | <b>Conformity to standards</b> | UL 508, CSA C22.2, CSA No. 213, UL 1604, CE |  |                       |                |                              |   |
| <b>References</b> | TCSESB083F23F0                 |   | TCSESB083F2CU0   |                       | TCSESB093F2CU0 |                              |   |



| Type of gateway                   |   | TSX ETG 100  |   |
|-----------------------------------|---|--|---|
| <b>Transparent Ready services</b> | Class   | B10  |   |
|                                   | Standard Web services                             | Configuration  | Predefined Web pages  |
|                                   |   | Read/Write   | Acces to connected products list, reading of Modbus devices registers |
|                                   |   | Diagnostic   | Via predefined Web pages : diagnostic on Ethernet and Modbus links    |
|                                   | Ethernet TCP/IP communication management services | Modbus messaging   | Read/Write Modbus registers of connected devices                      |
|                                   |   | SNMP   | SNMP Agent, device administration with a SNMP manager                 |
|                                   |   | BOOTP protocol   | FDR Client (replacement of defective product)                         |
| Security                          |   | Miniature firewall on-board (IP address filtering) and password protection     |   |
| <b>Ethernet connectivity</b>      | Physical interface                                | 10BASE-T/100BASE-TX (RJ45)   |   |
|                                   | Data rate   | 10/100 Mbps with automatic recognition   |   |
|                                   | Medium  | Twisted pair   |   |
| <b>Modbus connectivity</b>        | Type of port                                      | RS 485 (2 or 4-wire) or RS 232   |   |
|                                   | Protocol  | Modbus (RTU and ASCII)   |   |
|                                   | Maxi transmission speed                           | 38,4 Kbps (RS 485), 57,6 Kbps (RS 232)   |   |
|                                   | Number of devices                                 | 32 max.  |   |
| <b>Power supply</b>               |   | 24 VDC, 4 W or by power supply device PoE (Power Over Ethernet - IEEE 802.3af) |   |
| <b>Degree of protection</b>       |   | IP 30  |   |
| <b>Dimensions W x H x D</b>       |   | 72 x 81 x 76 mm, mounting on symmetrical DIN rail                              |   |
| <b>Conformity to standards</b>    |   | UL, cUL (conforming to CSA C22-2 no. 14-M91), UL508 , C-TICK, CE               |   |
| <b>Reference</b>                  |   | <b>TSX ETG 100 (1)</b>   |   |

(1) Fonctions: Twido, Compact, Momentum, TSX Micro, Altivar, Altistart, Magelis, ... All products compatible with Modbus standard.



7

| Type of gateway                   |   | Ethernet/Modbus Plus gateway/router Class B10 |  |
|-----------------------------------|---|---|--|
| <b>Transparent Ready services</b> | Class   | B10   |  |
|                                   | Standard Web services                           | Configuration                                 | Predefined Web pages   |
|                                   |   | Read/Write                                    | Acces to connected products list, reading of Modbus Plus devices registers |
|                                   |   | Diagnostic                                    | Via predefined Web pages : diagnostic on Ethernet and Modbus Plus links    |
|                                   | Standard Ethernet TCP/IP communication services |   | Modbus TCP messaging   |
|                                   |   |   | SNMP Agent   |
|                                   | <b>Functions</b>                                | Communication gateway                         | Ethernet/Modbus Plus (many-to-many Modbus Plus)                            |
| Interface for programming         |   | Ethernet/Modbus Plus                          |  |
| <b>Interfaces</b>                 | Ethernet TCP/IP port                            | Type  | 1 x 10BASE-T/100BASE-TX  |
|                                   |   | Shielded connectors                           | RJ45   |
|                                   |   | Medium  | Shielded twisted pair  |
|                                   | Serial port                                     | Max. distances                                | 100 m (327 ft)   |
|                                   |   | Type  | 1 x Modbus Plus  |
|                                   |   | Shielded connectors                           | 9-way SUB-D connector  |
| <b>Power supply</b>               | Voltage   | Medium  | Shielded twisted pair (single or double)                                   |
|                                   |   |   | 110/220 VAC (93.5 VAC...242 VAC), 47...63 Hz                               |
| <b>Degree of protection</b>       |   | IP 20   |  |
| <b>Dimensions W x H x D</b>       |   | 122 x 229 x 248 mm                            |  |
| <b>Conformity to standards</b>    |   | UL 508, CSA 142, CE                           |  |
| <b>Reference</b>                  |   | <b>174 CEV 200 40 (2)</b>                     |  |

(2) Fonctions: 1 Ethernet port, 10BASE-T/100BASE-TX, 1 Modbus Plus port



## Ethernet TCP/IP, Transparent Ready Cabling system: Connection components Shielded copper connection cables

ConneXium shielded connection cables are available in two versions to meet the various current standards and approvals:

These cables conform to:

- EIA/TIA-568 standard, category CAT 5E,
- IEC 11801/EN 50173 standard, class D.

Their fire resistance conforms to:

- NFC 32070# C2 classification
- IEC 322/1 standards
- Low Smoke Zero Halogen (LSZH).

### EIA/TIA 568 shielded twisted pair cables



#### EIA/TIA 568 shielded twisted pair cables for CE market

| Length                     | m / (ft)               | 2 (6.6)   | 5 (16.4)       | 12 (39.4)      | 40 (131.2)     | 80 (262.5)     |
|----------------------------|------------------------|---|----------------|----------------|----------------|----------------|
| <b>Straight cables</b>     | Preformed at both ends | 2 RJ45 connectors for connection to terminal devices (DTE)                |                |                |                |                |
| <b>References</b>          |                        | 490 NTW 000 02  | 490 NTW 000 05 | 490 NTW 000 12 | 490 NTW 000 40 | 490 NTW 000 80 |
| <b>Crossed cord cables</b> | Preformed at both ends | 2 RJ45 connectors for connections between hubs, switches and transceivers |                |                |                |                |
| <b>References</b>          |                        | -   | 490 NTC 000 05 | -              | 490 NTC 000 40 | 490 NTC 000 80 |

### Ethernet cables

| Ethernet cables   |           |               |               |               |               |                |
|-------------------|-----------|---------------|---------------|---------------|---------------|----------------|
| Length            | m / (ft)  | 1 (3.3)       | 2 (6.6)       | 3 (9.8)       | 5 (16.4)      | 10 (32.8)      |
|                   |           | Cat 5E w/RJ45 |               |               |               |                |
| <b>References</b> | <b>CE</b> | TCSECE3M3M1S4 | TCSECE3M3M2S4 | TCSECE3M3M3S4 | TCSECE3M3M5S4 | TCSECE3M3M10S4 |
|                   | <b>UL</b> | TCSECU3M3M1S4 | TCSECU3M3M2S4 | TCSECU3M3M3S4 | TCSECU3M3M5S4 | TCSECU3M3M10S4 |

### EIA/TIA 568 shielded twisted pair cables



Cable material is :

- CEC type FT-1
- NEC type CM

#### EIA/TIA shielded twisted pair cables for UL markets

| Length                     | m / (ft)               | 2 (6.6)   | 5 (16.4)        | 12 (39.4)       | 15 (49.2)       | 40 (131.2)      | 80 (262.5)      |
|----------------------------|------------------------|---|-----------------|-----------------|-----------------|-----------------|-----------------|
| <b>Straight cables</b>     | Preformed at both ends | 2 RJ45 connectors for connection to terminal devices (DTE)                |                 |                 |                 |                 |                 |
| <b>References</b>          |                        | 490 NTW 000 02U   | 490 NTW 000 05U | 490 NTW 000 12U | -               | 490 NTW 000 40U | 490 NTW 000 80U |
| <b>Crossed cord cables</b> | Preformed at both ends | 2 RJ45 connectors for connections between hubs, switches and transceivers |                 |                 |                 |                 |                 |
| <b>References</b>          |                        | -   | 490 NTC 000 05U | -               | 490 NTC 000 12U | 490 NTC 000 40U | 490 NTC 000 80U |

### Cables M12



| Cables M12       |            |                  |   |    |    |    |
|------------------|------------|------------------|---|----|----|----|
| M12 / M12        | Length (m) | 1                | 3 | 10 | 25 | 40 |
| <b>Reference</b> |            | TCSECL1M1M●●S2●● |   |    |    |    |
| RJ45 / M12       | Length(m)  | 1                | 3 | 10 | 25 | 40 |
| <b>Reference</b> |            | TCSECL1M3M●●S2●● |   |    |    |    |

### Glass fiber optic cables



These glass fiber optics are for making connections:

- To a terminal device (DTE)
- Between hubs, transceivers and switches

| Glass fiber optic cables        |                        |                                     |  |                    |                |
|---------------------------------|------------------------|-------------------------------------|--|--------------------|----------------|
| Length                          | m / (ft)               | 5 (16.4)                            | 5 (16.4)                                   | 3 (9.8)            | 5 (16.4)       |
| <b>Glass fiber optic cables</b> | Preformed at both ends | 1 SC connector<br>1 MT-RJ connector | 1 ST connector (BFOC)<br>1 MT-RJ connector | 2 MT-RJ connectors |                |
| <b>References</b>               |                        | 490 NOC 000 05                      | 490 NOT 000 05                             | 490 NOR 000 03     | 490 NOR 000 05 |



| Access Points and Clients                   |                                     | Dual band industrial wireless LAN Access Point/Client based on IEEE 802.11a/b/g/h/i |  | Dual band industrial high performance wireless LAN Access Point/Client based on IEEE 802.11a/b/g/h/n |  |
|---|-------------------------------------|---|--|--|--|
| <b>Wireless standard</b>                    |                                     | IEEE 802.11a/b/g/h/i  | IEEE 802.11a/b/g/h/i                         | IEEE 802.11a/b/g/h/n   | IEEE 802.11a/b/g/h/n                         |
| <b>Operating frequencies</b>                |                                     | 2.4GHz & 5GHz   | 2.4GHz & 5GHz                                | 2.4GHz & 5GHz  | 2.4GHz & 5GHz                                |
| <b>IP Rating</b>                            |                                     | IP 40   | IP 67  | IP 40  | IP 67  |
| <b>Mounting</b>                             |                                     | Din Rail  | Wall / Mast                                  | Din Rail   | Wall / Mast                                  |
| <b>Radios</b>                               |                                     | Access Point: 2<br>Client: 1  | 2  | 1  | 1  |
| <b>Nominal Data rate</b>                    |                                     | 54 Mbps   | 54 Mbps                                      | 300 Mbps   | 300 Mbps                                     |
| <b>Antenna connections</b>                  |                                     | 4 x RP-SMA  | 4 x N-type                                   | 3 x RP-SMA   | 4 x N-type                                   |
| <b>Ethernet connections (10/100BASE-TX)</b> |                                     | Access Points: 2<br>Client: 1   | 1  | 2  | 2  |
| <b>Wireless connections</b>                 |                                     | 2 x WLAN Interfaces<br>8 SSIDs per interface  | 2 x WLAN Interfaces<br>8 SSIDs per interface | 1 x WLAN Interfaces<br>8 SSIDs per interface   | 1 x WLAN Interfaces<br>8 SSIDs per interface |
| <b>References</b>                           | <b>Global</b>                       | <b>TCSGWA242</b>  | <b>TCSGWA272</b>                             | <b>TCSNWA241</b>   | <b>TCSNWA271</b>                             |
|   | <b>North America (FCC approved)</b> | <b>TCSGWA242F</b>   | –  | <b>TCSNWA241F</b>  | <b>TCSNWA271F</b>                            |
|   | <b>Client only</b>                  | <b>TCSGWC241</b>  | –  | –  | –  |
|   | <b>ATEX Compliant</b>               | –   | –  | –  | <b>TCSNWA2A1</b>                             |

| Antennas  |                                      | TSCG**** Compatible References (1) | TSCN**** Compatible References (1) |
|-----------|--------------------------------------|------------------------------------|------------------------------------|
| 2.4 GHz   | 2.4 GHz Omni Directional (6dBi)      | <b>TCSWAB20</b>                    | –                                  |
|           | 2.4 GHz Directional (14dBi)          | <b>TCSWAB2D</b>                    | –                                  |
|           | 2.4 GHz Dual Slant (8dBi)            | <b>TCSWAB2S</b>                    | <b>TCSWAB2S</b>                    |
|           | Leaky Cable – 50 meter               | <b>TCSWABC5</b>                    | –                                  |
|           | Leaky Cable – 100 meter              | <b>TCSWABC10</b>                   | –                                  |
| 5 GHz     | 5 GHz Omni Directional (5dBi)        | <b>TCSWAB50</b>                    | –                                  |
|           | 5 GHz Directional – Medium (18.5dBi) | <b>TCSWAB5D</b>                    | –                                  |
|           | 5 GHz Directional – Long (23dBi)     | <b>TCSWAB5V</b>                    | <b>TCSWAB5V</b>                    |
|           | 5 GHz Directional – 802.11n (23dBi)  | <b>TCSWAB5VN</b>                   | <b>TCSWAB5VN</b>                   |
|           | 5 GHz Dual Slant (9dBi)              | <b>TCSWAB5S</b>                    | –                                  |
|           | 5 GHz Directional – 802.11n (9dBi)   | –                                  | <b>TCSWAB5DN</b>                   |
| Dual Band | Dual Band Hemispherical (6dBi/8dBi)  | <b>TCSWABDH</b>                    | –                                  |
|           | Dual Band Omni (3.5dBi/5.5dBi)       | –                                  | <b>TCSWABDON</b>                   |

(1) Consult [www.schneider-electric.com](http://www.schneider-electric.com) for a complete list of antenna cables and accessories for WiFi products

Large area with horizontal green and light green stripes, serving as a template for notes.



| Modular interface, width 25 mm<br>V2.1 with standard addressing | Analogue                               |                   | Digital             |                     |                      |
|---|--|-------------------|---------------------|---------------------|----------------------|
|   | Number of inputs                       | 2 (0...10V)       | 2 (0/4...20mA)      | 4                   | 4                    |
| Number of outputs   | –                                      | –                 | 4 relay, 2A         | 4 solid state, 0.5A | 4 solid state, 0.5A  |
| Type of addressing  | Standard                               |                   |                     |                     |                      |
| Supply by AS-Interface  | Inputs and sensor supply (200 mA max.) |                   |                     |                     | –                    |
| Supply by 24 VDC external source (black AUX cable)              | –                                      | –                 | –                   | Outputs             | (2)                  |
| AS-Interface profile  | S.7.3.F.D                              | S.7.3.F.D         | S.7.0.F.E           | S.7.0.F.E           | S.7.0.F.E            |
| Maximum consumption from AS-Interface (excluding sensor supply) | 60 mA                                  | 60 mA             | 110 mA              | 50 mA               | 20 mA                |
| Dimensions (WxDxH)  | 25x77x87 mm                            | 25x77x87 mm       | 25x77x87 mm         | 25x77x87 mm         | 25x77x87 mm          |
| <b>References</b>   | <b>ASI20MA2VU</b>                      | <b>ASI20MA2VI</b> | <b>ASI20MT4I4OR</b> | <b>ASI20MT4I4OS</b> | <b>ASI20MT4I4OSA</b> |
| <b>Accessory (1) for connection to flat cables</b>              | <b>TCSATN01N2</b>                      | <b>TCSATN01N2</b> | <b>TCSATN01N2</b>   | <b>TCSATV01N2</b>   | <b>TCSATV01N2</b>    |

(1) Or direct screw terminal connection (without accessory).

(2) Inputs, outputs and sensor supply (200 mA max.).



| Modular interface, width 25 mm<br>V2.1 with Extended (A/B) addressing | Digital                                    |                      |                      |                      |                       |
|---|--|----------------------|----------------------|----------------------|-----------------------|
|   | Number of inputs                           | 4                    | 2                    | 4                    | 4                     |
| Number of outputs   | –  | 1 triac, 2A          | 3 relay, 2A          | 3 solid state, 0.5A  | 3 solid state, 0.5A   |
| Type of addressing  | Extended (A/B)                             |                      |                      |                      |                       |
| Supply by AS-Interface  | Inputs and sensor supply (200 mA max.) (3) |                      |                      |                      | –                     |
| Supply by 24 VDC external source (black AUX cable)                    | –  | –                    | –                    | Outputs              | (2)                   |
| AS-Interface profile  | S.0.A.7.0                                  | S.3.A.7.0            | S.7.A.7.0            | S.7.A.7.0            | S.7.A.7.0             |
| Maximum consumption from AS-Interface (excluding sensor supply)       | 50 mA                                      | 40 mA                | 90 mA                | 50 mA                | 20 mA                 |
| Dimensions (WxDxH)  | 25x77x87 mm                                | 25x77x87 mm          | 25x77x87 mm          | 25x77x87 mm          | 25x77x87 mm           |
| <b>References</b>   | <b>ASI20MT4IE</b>                          | <b>ASI20MT2I1OTE</b> | <b>ASI20MT4I3ORE</b> | <b>ASI20MT4I3OSE</b> | <b>ASI20MT4I3OSAE</b> |
| <b>Accessory (1) for connection to flat cables</b>                    | <b>TCSATN01N2</b>                          | <b>TCSATN01N2</b>    | <b>TCSATN01N2</b>    | <b>TCSATV01N2</b>    | <b>TCSATV01N2</b>     |

(1) Or direct screw terminal connection (without accessory).

(2) Inputs, outputs and sensor supply (200 mA max.).

(3) Except ASI20MT4I3ORE (170 mA max.).

## IP67 for mounting on machine



| Interface   |               |                             | Digital   |                   |                   |                   |                |                   |                |
|---|---------------|-----------------------------|---|-------------------|-------------------|-------------------|----------------|-------------------|----------------|
| V2.1 with extended (A/B) addressing                             |               |                             |   |                   |                   |                   |                |                   |                |
| Number of inputs  |               |                             | 4   | 2                 | –                 | 4                 | 4              | 4                 | 8              |
| Input cabling   |               |                             | Standard (1 x M12)  |                   |                   | "Y" (2 x M12)     |                | "Y" (4 x M12)     |                |
| Number of outputs   |               |                             | –   | 2 solid-state, 2A | 3 solid-state, 2A | 3 solid-state, 2A | –              | 3 solid-state, 2A | –              |
| Type of addressing  |               |                             | Extended (A/B)  |                   |                   |                   |                |                   |                |
| Supply by AS-Interface  |               |                             | Inputs and sensor supply (200 mA max. except ASI67FFP22*: 100 mA) |                   |                   |                   |                |                   |                |
| Supply by 24 VDC external source (black AUX cable)              |               |                             | –   | Outputs           | –                 | Outputs           | –              | Outputs           | –              |
| AS-Interface profile  |               |                             | S.0.A.7.0   | S.B.A.7.0         | S.8.A.7.0         | S.7.A.7.0         | S.0.A.7.2      | S.7.A.7.E         | S.0.A.7.2 (2x) |
| Maximum consumption from AS-Interface (excluding sensor supply) |               |                             | 45 mA   | 32 mA             | 18 mA             | 48 mA             | 45 mA          | 48 mA             | 90 mA          |
| Dimensions (WxDxH)  |               |                             | 45x42x80mm  | 45x42x80mm        | 45x42x80mm        | 60x30,5x151mm     | 45x42x80mm     | 60x30,5x151mm     | 60x30,5x151mm  |
| Connection  | IDC           | Interface                   | ASI67FFP40E   | ASI67FFP22E       | ASI67FFP03E       | ASI67FFP43E       | ASI67FFP40EY   | ASI67FFP43EY      | ASI67FFP80EY   |
|   |               | Standard connection base    | ASI67FFB01 (1)  | ASI67FFB01 (1)    | ASI67FFB01 (1)    | ASI67FFB03        | ASI67FFB01 (1) | ASI67FFB03        | ASI67FFB03     |
|   | M12 connector | Interface + Connection base | ASI67FMP40E   | ASI67FMP22E       | ASI67FMP03E       | ASI67FMP43E       | ASI67FMP40EY   | ASI67FMP43EY      | –              |

(1) A connection base with fixing centres that are compatible with the ASIB4VM12 connection base is available. Reference **ASI67FFB02**.



| Interface   |               |                             | Digital   |                   |                   |                   |                   |                |  |
|---|---------------|-----------------------------|---|-------------------|-------------------|-------------------|-------------------|----------------|--|
| V2.1 with standard addressing                                   |               |                             |   |                   |                   |                   |                   |                |  |
| Number of inputs  |               |                             | 4   | 2                 | –                 | 4                 | 4                 | 8              |  |
| Input cabling   |               |                             | Standard (1 x M12)  |                   |                   | "Y" (2 x M12)     |                   | "Y" (4 x M12)  |  |
| Number of outputs   |               |                             | –   | 2 solid-state, 2A | 4 solid-state, 2A | 4 solid-state, 2A | 4 solid-state, 2A | –              |  |
| Type of addressing  |               |                             | Standard  |                   |                   |                   |                   |                |  |
| Supply by AS-Interface  |               |                             | Inputs and sensor supply (200 mA max. except ASI67FFP22*: 100 mA) |                   |                   |                   |                   |                |  |
| Supply by 24 VDC external source (black AUX cable)              |               |                             | –   | Outputs           | Outputs           | Outputs           | Outputs           | –              |  |
| AS-Interface profile  |               |                             | S.0.0.F.E   | S.3.0.F.E         | S.8.0.F.E         | S.7.0.F.E         | S.7.1.F.E         | S.0.1.F.F (2x) |  |
| Maximum consumption from AS-Interface (excluding sensor supply) |               |                             | 45 mA   | 32 mA             | 19 mA             | 49 mA             | 49 mA             | 90 mA          |  |
| Dimensions (WxDxH)  |               |                             | 45x42x80mm  | 45x42x80mm        | 45x42x80mm        | 60x30,5x151mm     | 60x30,5x151mm     | 60x30,5x151mm  |  |
| Connection  | IDC           | Interface                   | ASI67FFP40D   | ASI67FFP22D       | ASI67FFP04D       | ASI67FFP44D       | ASI67FFP44DY      | ASI67FFP80DY   |  |
|   |               | Standard connection base    | ASI67FFB01 (1)  | ASI67FFB01 (1)    | ASI67FFB01 (1)    | ASI67FFB03        | ASI67FFB03        | ASI67FFB03     |  |
|   | M12 connector | Interface + Connection base | ASI67FMP40D   | ASI67FMP22D       | ASI67FMP04D       | ASI67FMP44D       | ASI67FMP44DY      | –              |  |

(1) A connection base with fixing centres that are compatible with the ASIB4VM12 connection base is available. Reference **ASI67FFB02**.



| Interface   |     |                          | Digital   |                   |                   |                   |
|---|-----|--------------------------|---|-------------------|-------------------|-------------------|
| V2.1 (V1 compatible) with standard addressing                   |     |                          |   |                   |                   |                   |
| Number of inputs  |     |                          | 4   | 2                 | –                 | 4                 |
| Input cabling   |     |                          | Standard (1 x M12 input)  |                   |                   |                   |
| Number of outputs   |     |                          | –   | 2 solid-state, 2A | 4 solid-state, 2A | 4 solid-state, 2A |
| Type of addressing  |     |                          | Standard  |                   |                   |                   |
| Supply by AS-Interface  |     |                          | Inputs and sensor supply (200 mA max. except ASI67FFP22*: 100 mA) |                   |                   |                   |
| Supply by 24 VDC external source (black AUX cable)              |     |                          | –   | Outputs           | Outputs           | Outputs           |
| AS-Interface profile  |     |                          | S.0.0.F.F   | S.3.0.F.F         | S.8.0.F.F         | S.7.0.F.F         |
| Maximum consumption from AS-Interface (excluding sensor supply) |     |                          | 45 mA   | 32 mA             | 19 mA             | 49 mA             |
| Dimensions (WxDxH)  |     |                          | 45x42x80 mm   | 45x42x80 mm       | 45x42x80 mm       | 60x30,5x151 mm    |
| Connection  | IDC | Interface                | ASI67FFP40A   | ASI67FFP22A       | ASI67FFP04A       | ASI67FFP44A       |
|   |     | Standard connection base | ASI67FFB01  | ASI67FFB01        | ASI67FFB01        | ASI67FFB03        |

# AS-Interface Dedicated components For control



| Starter in insulated enclosure (1)<br>V1           |               | Control by                                |             |
|--|---------------|---|-------------|
|  |               | Black rotary knob (blue bkgnd.)           | Pushbuttons |
| Type of addressing                                 |               | Standard                                  |             |
| Supply by AS-Interface                             |               | Inputs, sensor supply (2)                 |             |
| Supply by 24 VDC external source (black AUX cable) |               | (2)                                       |             |
| AS-Interface profile                               |               | S.7.F.F. (LF3....) / S.7.A.7.0. (LF4....) |             |
| Maximum consumption from AS-Interface              |               | 20 mA                                     |             |
| Dimensions (WxDxH)                                 |               | 175x175x195 mm                            |             |
| References (3)<br>(see table below)                | Non reversing | LF3P●●D                                   | LF3M●●D     |
|  | Reversing     | LF4P●●D                                   | LF4M●●D     |

Connection to AS-Interface and external supply (AUX) by accessory for flat cable: **TCSATN011F1** (AS-Interface and AUX cables) or **TCSATV011F1** (AS-Interface cable).

(1) For an LF3 or LF4 starter in a metal enclosure, add the letter **M** after the 3<sup>rd</sup> digit in the references listed above (example: LF3P02D becomes **LF3MP02D**).

(2) Contactors supplied by AS-Interface or external source, configurable directly on terminal block.

(3) To complete the reference, replace ●● by the numbers indicated in the table below. (Example: LF3P●●D becomes LF3P00D).

| kW          | A           | ●● | kW        | A         | ●● |
|-------------|-------------|----|-----------|-----------|----|
| –           | without MCB | 00 | 0.75      | 1.6...2.5 | 07 |
| 0.06        | 0.16...0.25 | 02 | 1.1 / 1.5 | 2.5...4   | 08 |
| 0.09        | 0.25...0.40 | 03 | 2.2       | 4...6.3   | 10 |
| 0.12 / 0.18 | 0.40...0.63 | 04 | 3 / 4     | 6...10    | 14 |
| 0.25        | 0.63...1    | 05 | 5.5       | 9...14    | 16 |
| 0.37/ 0.55  | 1...1.6     | 06 |           |           |    |

**kW**= Motor power ratings in category AC-3, 400/415V, in kilowatts.

**A**= Adjustable range of circuit-breaker thermal trips, in amperes.

7



| Communication interface for<br>V2.1                            |  | TeSys U               |                       |
|--|--|-----------------------|-----------------------|
| Type of addressing   |  | Standard              | Extended (A/B)        |
| Supply by AS-Interface   |  | –                     | –                     |
| Supply by external source (AUX)                                |  | Coil                  | Coil                  |
| AS-Interface profile   |  | S.7.D.F.0             | 7.A.7.E               |
| Maximum consumption from AS-Interface                          |  | 30 mA                 | 30 mA                 |
| Dimensions (WxDxH)   |  | depending on LU model | depending on LU model |
| References   |  | ASILUFC5              | ASILUFC51             |
| Recommended accessory for connection to AS-Interface cable (4) |  | TCSATV01N2            | TCSATV01N2            |

(4) Or direct screw terminal connection to AS-Interface and external supply (AUX).

## For dialogue



| Control stations<br>V2.1  | Control stations with 2 pushbuttons |                    |                           |
|---|-------------------------------------|--------------------|---------------------------|
|   | Black and white                     | Green and red      | Green and red illuminated |
| Type of addressing  | Extended (A/B)                      | Extended (A/B)     | Extended (A/B)            |
| Supply by AS-Interface  | Buttons                             | Buttons            | Buttons and pilot lights  |
| Supply by external source (AUX)                                       | –                                   | –                  | –                         |
| AS-Interface profile  | S.B.A.E.                            | S.B.A.E.           | S.B.A.E.                  |
| Consumption from AS-Interface   | < 45 mA                             | < 45 mA            | < 80 mA                   |
| Dimensions (WxDxH)  | 68x62x118 mm                        | 68x62x118 mm       | 68x65x118 mm              |
| <b>References</b>   | <b>XALS2001H</b>                    | <b>XALS2002H</b>   | <b>XALS2003H</b>          |
| <b>Recommended accessory for connection to AS-Interface cable (5)</b> | <b>TCSATN011F1</b>                  | <b>TCSATN011F1</b> | <b>TCSATN011F1</b>        |

(5) Or direct screw terminal connection to AS-Interface and external supply (AUX).



| Interface (6)<br>V2.1                 | For 2 control units and 2 pilot lights |
|---------------------------------------|--|
| Number of pages available             | –                                      |
| Number of inputs                      | 2                                      |
| Number of outputs                     | 2 solid state, 0.5 A                   |
| Type of addressing                    | Standard                               |
| Supply by AS-Interface                | Inputs and pilot lights                |
| AS-Interface profile                  | S.B.A.E.                               |
| Maximum consumption from AS-Interface | 80 mA                                  |
| Dimensions (WxDxH)                    | 52x15x38 mm                            |
| <b>References</b>                     | <b>XALSZ1E</b>                         |

(6) Direct screw terminal connection to AS-Interface or by accessory for flat cable: **TCSATN01N2**.



| Indicator banks, Ø 70 mm (9)<br>V2.1  | Base units and cover |                   | Illuminated units      |                    | Audible unit     |
|---|----------------------|-------------------|------------------------|--------------------|------------------|
|   |                      |                   | "Flash" discharge tube | Steady light       |                  |
| Type of addressing  | Standard             | Standard          | –                      | –                  | –                |
| Connection to AS-Interface cable and AUX (male M12 connector)               | yes                  | yes, remote L=1m  | –                      | –                  | –                |
| Supply by AS-Interface  | (7)                  | (7)               | –                      | –                  | –                |
| Supply by external source (AUX)   | (7)                  | (7)               | –                      | –                  | –                |
| AS-Interface profile  | S.7.F                | S.7.F             | –                      | –                  | –                |
| Consumption from AS-Interface, supply by AS-Interface / external            | 250 / 30 mA          | 250 / 30 mA       | –                      | –                  | –                |
| Light source  | –                    | –                 | 5 Joule                | LED                | –                |
| Buzzer  | –                    | –                 | –                      | –                  | 70...80 dB at 1m |
| <b>References</b>   | <b>XVBC21A</b>       | <b>XVBC21B</b>    | <b>XVBC6B● (8)</b>     | <b>XVBC2B● (8)</b> | <b>XVBC9B</b>    |
| <b>Recommended accessory for connection to AS-Interface cable &amp; AUX</b> | <b>TCSATN011F1</b>   | <b>TCSATN011F</b> | –                      | –                  | –                |

(7) Illuminated units supplied by AS-Interface or externally, configurable by shunt.

(8) To complete the reference, replace the ● by the following number designating the colour: green: 3, red: 4, orange: 5, blue: 6, clear: 7, yellow: 8.

(9) To obtain a complete indicator bank, order a base unit + the illuminated or audible units (5 units maximum).

# AS-Interface Installation system

## Master modules



| Platform  | Twido                     | Premium                          | Micro             | Quantum            | Ethernet GW               |
|---|---------------------------|----------------------------------|-------------------|--------------------|---------------------------|
| Maximum number of master modules per PLC                  | 2                         | 2, 4 or 8 depending on processor | 1                 | 8 (1)              | –                         |
| Compatibility with AS-Interface interfaces and components | V1 / V2.1                 | V1 / V2.1                        | V1                | V1                 | V1 / V2.1 / V3.0          |
| Direct connection to AS-Interface cable                   | by terminal block         | by terminal block                | by terminal block | by terminal block  | by terminal block         |
| Maximum number of addresses                               | 62                        | 62                               | 31                | 31                 | 62                        |
| Type of addressing  | Standard / Extended (A/B) | Standard / Extended (A/B)        | Standard          | Standard           | Standard / Extended (A/B) |
| Compatibility with analogue interfaces                    | Yes                       | Yes                              | –                 | –                  | Yes                       |
| Compatibility with safety interfaces                      | Yes                       | Yes                              | Yes               | Yes                | Yes                       |
| AS-Interface profile                                      | M.3                       | M.2.E                            | M.2               | M.2                | M.4                       |
| <b>References</b>   | <b>TWDNOI10M3</b>         | <b>TSXSAY1000</b>                | <b>TSXSAZ10</b>   | <b>140EIA92100</b> | <b>TCSAGEA1SF13F</b>      |

(1) 4 per local rack, 4 per remote I/O, 2 per distributed I/O.

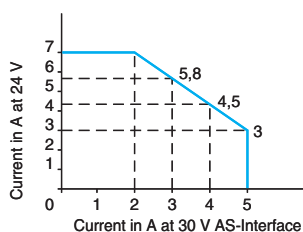

## Power supply units



| Type of supply                          | AS-Interface                  |                    | AS-Interface + Auxiliary |
|---|-------------------------------|--------------------|--------------------------|
| Input voltage                           | 100...240 VAC                 | 100...240 VAC      | 100...240 VAC            |
| AS-Interface output voltage             | 30 VDC                        | 30 VDC             | 30 VDC                   |
| Auxiliary output voltage                | –                             | –                  | 24 VDC                   |
| AS-Interface nominal power              | 73 W                          | 146 W              | 73 W                     |
| Auxiliary nominal power                 | –                             | –                  | 72 W                     |
| AS-Interface nominal current            | 2.4 A                         | 4.8 A              | 2.4 A                    |
| AUX nominal current                     | –                             | –                  | 3 A                      |
| Direct connection to AS-Interface cable | by terminal block             | by terminal block  | by terminal block        |
| Dimensions (WxDxH)                      | 54x120x120 mm                 | 81x120x120 mm      | 81x120x120 mm            |
| <b>References</b>                       | without earth fault detection | <b>ASIABL3002</b>  | <b>ASIABL3004</b>        |
|   | with earth fault detection    | <b>ASIABLD3002</b> | <b>ASIABLD3004</b>       |
|   |                               |                    | <b>ASIABLM3024</b>       |

(2) Power supply unit with constant maximum output, see curve above.

## Insulation control relay



| Type                      | For AS-Interface line             |
|---------------------------|-----------------------------------|
| Degree of protection      | IP20                              |
| Number of C/O contacts    | 2 relays, each with 1 N/O contact |
| Rated operational voltage | 50 VDC                            |
| Dimensions (WxDxH)        | 90x58x76 mm                       |
| <b>References</b>         | <b>RM0PAS101 (3)</b>              |

(3) Provided with an impedance adapter.



## Cables, repeater and line extension



| Type                  | Yellow AS-Interface cable | Black Auxiliary cable   | Repeater (5)  | Line Extension |   |
|-----------------------|---------------------------|-------------------------|---------------|----------------|---|
| Wire c.s.a.           | 2 x 1.5 mm <sup>2</sup>   | 2 x 1.5 mm <sup>2</sup> | –             | –              |   |
| References            | Cable                     | L = 20 m                | XZCB10201 (4) | XZCB10202 (4)  | – |
|                       |                           | L = 50 m                | XZCB10501 (4) | XZCB10502 (4)  | – |
|                       |                           | L = 100 m               | XZCB11001 (4) | XZCB11002 (4)  | – |
| Reference of repeater | –                         | –                       | ASIRPT01      | TCSARR011M     |   |

(4) Standard cable. For TPE cable (oil and vapour resistant) add the letter **H** to the end of the reference, example: XZCB10201 becomes **XZCB10201H**.

(5) Enables an AS-Interface network to be extended by 100 m. Direct connection to the AS-Interface yellow cable by IDC

## Tap-offs for flat cable

(For connecting interfaces and components)



| Connection to cable by IDC               | AS-Interface IP67 | AS-Interface + Auxiliary IP67 |             |            |             |            |
|--|-------------------|-------------------------------|-------------|------------|-------------|------------|
| Connection to the AS-Interface component | M12 connector (6) | Bared wires (7)               |             |            |             |            |
| References                               | Cable             | L = 1 m                       | TCSATN011F1 | –          | TCSATV011F1 | –          |
|  |                   | L = 2 m                       | TCSATN011F2 | TCSATN01N2 | TCSATV011F2 | TCSATV01N2 |

(6) Female 5-pin M12 end connector, screw threaded for connection with M12 male connector.

(7) 2 x 0.34 mm<sup>2</sup> for product with terminal block.

(8) 4 x 0.34 mm<sup>2</sup> for product with terminal block.

7

## T connectors



| Connection to cable by IDC                        | T connector AS-Interface IP 67                 | Branch AS-Interface or Auxiliaires IP 67 |
|---|--|--|
| Connection to the AS-Interface sensor or actuator | 1 x M12 connector 5-pin female, screw threaded | Extension for 2 flat cables              |
| References  | TCSATN011F                                     | TCSATN02V                                |

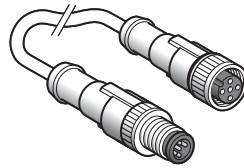

| Type                                |               | Male / Female jumper cable          |                                     |                                     |
|-------------------------------------|---------------|-------------------------------------|-------------------------------------|-------------------------------------|
| Male connector type, interface side |               | M12, 3-pin, straight, screw thread. | M12, 4-pin, straight, screw thread. | M12, 5-pin, straight, screw thread. |
| Female connector type, sensor side  |               | M12, 3-pin, straight, screw thread. | M12, 4-pin, straight, screw thread. | M12, 5-pin, straight, screw thread. |
| Cable                               |               | PUR, black                          | PUR, black                          | PUR, black                          |
| References                          | Cable L = 1 m | XZCR1511040A1                       | XZCR1511041C1                       | XZCR1511064D1                       |
|                                     | L = 2 m       | XZCR1511040A2                       | XZCR1511041C2                       | XZCR1511064D2                       |

## Jumper cables M12 / M8 or DIN

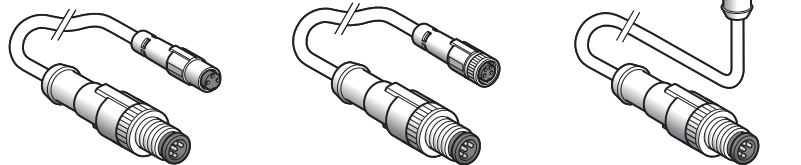

| Type                                |               | Male / Female jumper cable          |                                     |                                     |
|-------------------------------------|---------------|-------------------------------------|-------------------------------------|-------------------------------------|
| Male connector type, interface side |               | M12, 3-pin, straight, screw thread. | M12, 3-pin, straight, screw thread. | M12, 3-pin, straight, screw thread. |
| Female connector type, sensor side  |               | M8, 3-pin, straight (1)             | M8, 3-pin, straight, screw thread.  | DIN 43650A, elbowed, screw thrd.    |
| Cable                               |               | PUR, black                          | PUR, black                          | PUR, black                          |
| References                          | Cable L = 1 m | XZCR1501040G1                       | XZCR1509040H1                       | XZCR1523062K1                       |
|                                     | L = 2 m       | XZCR1501040G2                       | XZCR1509040H2                       | XZCR1523062K2                       |

(1) Clip together connector.

7

## Connectors, splitter box

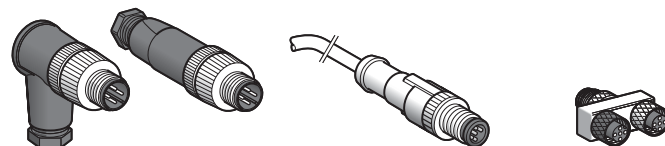

| Type                                |                                   | Connectors   | Pre-wired connectors                | Splitter box                          |
|-------------------------------------|-----------------------------------|--------------|-------------------------------------|---------------------------------------|
| Male connector type, interface side |                                   | M12, 4-pin   | M12, 5-pin, straight, screw thread. | 1 x M12, 5-pin, straight, screw thrd. |
| Female connector type, sensor side  |                                   | –            | –                                   | 2 x M12, 5-pin, straight, screw thrd. |
| Cable                               |                                   | –            | PUR, black                          | –                                     |
| References                          | Straight connector, screw thread. | XZCC12MDM40B | –                                   | FTXCY1212                             |
|                                     | Elbowed connector, screw thread.  | XZCC12MCM40B | –                                   | –                                     |
|                                     | Cable L = 0.5 m                   | –            | XZCP1564L05                         | –                                     |
|                                     | Cable L = 2 m                     | –            | XZCP1564L2                          | –                                     |

# Tools

## Adjustment and addressing terminals



|   |                            |
|---|----------------------------|
| <b>Display</b>  | <b>25 mm LCD screen</b>    |
| Degree of protection  | IP40                       |
| AS-Interface voltage / current measurement                    | yes                        |
| Addresses stored in memory                                    | yes                        |
| Access to functions   | direct by selector switch  |
| Compatibility   | V1/V2                      |
| Operating time  | 2500 addressing operations |
| <b>References</b>   | <b>ASITERV2</b>            |
| Reference with set of 7 leads + protective cover for terminal | ASITERV2SET                |

## Addressing accessories for terminals ASITERV2 and XZMC11

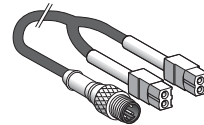
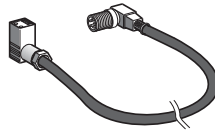

| Product connection | Infrared addressing | Socket                                       |
|--------------------|---------------------|--|
| For products       | ASISL...            | ABE8... / APP1 / ASILUF... / XBZS43 / ASI20M |
| <b>References</b>  | <b>ASITERIR1</b>    | <b>XZMG12</b>                                |

7

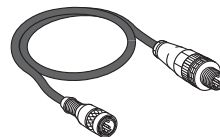
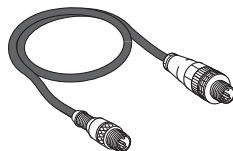

| Product connection | M12, male          | M12, female                         | Jack plug               |
|--------------------|--------------------|-------------------------------------|-------------------------|
| For products       | (2)                | ASI67FMP<br>XVB... / XAL... / LF... | ASI20M... / ASI67FFP... |
| <b>References</b>  | <b>ASITERACC1M</b> | <b>ASITERACC1F</b>                  | <b>ASITERACC</b>        |

(2) Possibility to connect AS-Interface cable using T connector TCSATN011F.



| Type          | OPC data server        |                         |
|---------------|------------------------|-------------------------|
|               | OFS Small              | OFS Large               |
| Items number  | 1000 items             | Unlimited               |
| OPC protocols | OPC DA                 | OPC DA, OPC XML DA,     |
| References    | Single station licence | <b>TLX CD SU OFS 33</b> |
|               | 10 stations licence    | <b>TLX CD ST OFS 33</b> |
|               | 200 stations licence   | <b>TLX CD LF OFS 33</b> |

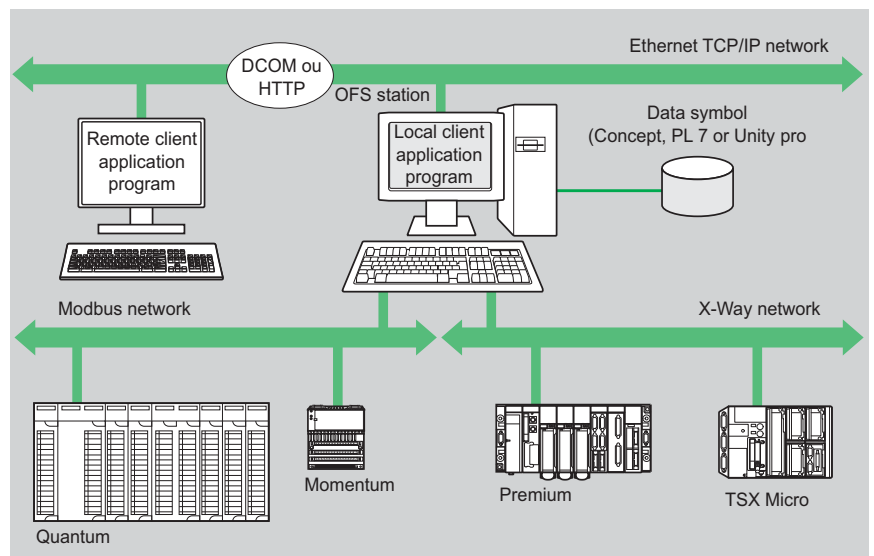

**Description:**

Based on the OPC protocols, Schneider-Electric's OFS software (**OPC Factory Server**) enables local or remote OPC client applications such as SCADA, supervisors or custom interfaces, to access Schneider devices and PLCs data in real time.

OFS software is a multi-device data server which provides simultaneous use of various communication protocols, and allows client applications to access control data via physical addresses or via symbols

**Supported devices :**

- Modicon Quantum, Premium, Micro, Compact and Momentum PLCs
- TSX Series 7 and April Series 1000 Schneider-Electric PLCs
- Serial Modbus or Uni-Telway devices connected via Schneider-Electric and Merlin Gerin gateways TSX ETG 10xx, EGX xxx ranges etc.

**Supported networks and protocols :**

- Modbus: Serial Modbus, Modbus Plus, Modbus TCP/IP.
- XWAY/UNI-TE: Uni-Telway, FIPWAY, ETHWAY, ISAWAY, PCIWAY.

**Openess:**

OFS V3.3, integrates the most recent specifications of the OPC Foundation:

- **OPC-DA** (OPC Data Access)
- **.NET API interface**
- **OPC XML-DA V1.0** (OPC XML Data Access)

The development of specialized interfaces is even more easy and open.

Developers and System integrators can develop custom applications (in Visual Basic, VBA for Excel, C++, etc) requiring access to Schneider Electric control devices. The OPC XML-DA V1.0 interface is designed to provide an interface for Windows and non-Windows client applications and remote access via the Internet through firewalls.

7





Embedded in the TCP/IP communication modules for Modicon M340, Premium and Quantum PLCs, FactoryCast Web servers provide secured access to the diagnostics, monitoring and maintenance functions of your automation installations via a simple web browser.

## FactoryCast modules for PLC

*“Ready to use” diagnostic and monitoring functions embedded in a PLC module accessible remotely via a simple Internet browser:*

- Real-time communication based on Ethernet TCP/IP (Modbus and Uni-TE)
- Secure access to the PLC system and application diagnostics
- Numerical or graphical data monitoring and control
- E-mail notifications
- Web server open to user customization and creation of Web pages for diagnostics suited to your needs
- Library of animated graphic objects
- Open communications using SOAP/XML protocol as a server interface (Web services)
- Visualization of Unity Pro IEC program via Web pages
- New - SilverLight based Rack Viewer
- New - Custom Web pages using Microsoft Expression Blend

## FactoryCast HMI modules for PLC

*Diagnostic functions identical as FactoryCast modules + Built-in HMI / SCADA functions embedded in a PLC module:*

- Visualization of Unity Pro PLC program and Operator screens via Web pages
- PLC data acquisition
- Calculations scripts for data-processing Real-time database (1000 variables)
- Alarm and report notifications via E-mail
- Archiving of data directly into database servers (SQL, Oracle, MySQL)
- Data logging in CSV files in the module.
- Recipe management with read Database
- Dynamic HTML Reporting function
- Web server open to user Web pages customization
- Built-in Supervision via graphic screens and custom Web pages
- Data monitoring and Graphic monitoring (read/write)
- Library of animated graphic objects
- Open communication using SOAP/XML protocol as a server interface (Web services)

## FactoryCast Gateways - ETG 1000 / 10.. modules

*Cost-effective web gateways offer integrating in a stand-alone module:*

- All Communications network interfaces: Ethernet TCP/IP, Modbus and Uni-Telway
- Remote access functions, RAS server,
- Transparent gateway / Router functions
- Notification of alarms via E-mail
- Data monitoring and Graphic monitoring (read/write)
- A user customizable Web server for creating an interface fully adapted to your needs
- Library of animated graphic objects



In the areas of distributed infrastructures, transport, RTU installations, industry and machines, ETG 1000 / 3000 modules more than satisfy your requirements for remote diagnostics and maintenance, remote monitoring and control, and remote programming.

## FactoryCast HMI Gateways - ETG 3000 / 30.. modules

*“All in one” Web gateway module integrating in a stand-alone device:*

- a built-in modem (PSTN or GSM/GPRS) depending on the reference
- Secured access : VPN, data encryption and IP filtering.
- A Remote Access server function (RAS)
- 2 Ethernet ports and a Modbus serial port
- Transparent gateway router functions NAT to Ethernet or Modbus serial devices
- I/O card : 6 discrete inputs/ 2 discrete outputs
- Operating temperature : -25°C to +75°C
- User customizable Web server
- Built-in Supervision via graphic screens and custom Web pages
- Data monitoring and Graphic monitoring (read/write)
- Data Acquisition, Data Processing and Data logging in the module (CSV files)
- Archiving of data directly into database servers (SQL, Oracle, MySQL)
- Alarms and reports via E-mail / SMS
- Open communication using SOAP/XML protocol as a server interface



| Applications                                |   | Web Server modules for PLCs   |                   |                      |                      |   |                      |
|---|---|---|-------------------|----------------------|----------------------|---|----------------------|
|   |   | FactoryCast   |                   |                      |                      | FactoryCast HMI   |                      |
| <b>Target devices</b>                       | Type                                    | TSX Micro PLCs  | Modicon M340 PLCs | Modicon Premium PLCs | Modicon Quantum PLCs | Modicon Premium PLCs  | Modicon Quantum PLCs |
| <b>Network &amp; Remote access services</b> | Remote access                           | Intranet or via external RAS/modem  |                   |                      |                      |   |                      |
|   |   | Remote programming, downloading via FTP, access to Web server via Internet browser  |                   |                      |                      |   |                      |
|   | Gateway function                        | -   |                   |                      |                      |   |                      |
|   | Serial protocols                        | -   |                   |                      |                      |   |                      |
|   | Ethernet protocols                      | Modbus TCP, Uni-TE  | Modbus TCP        | Modbus TCP, Uni-TE   | Modbus TCP           | Modbus TCP, Uni-TE  | Modbus TCP           |
|   | TCP/IP protocols                        | BootP/DHCP, DNS, SNMP agent, SMTP client, NTP client, FTP   |                   |                      |                      |   |                      |
| <b>Web server</b>                           | Characteristics                         | HTTP and FTP server, 8 Mb memory available for user add (32 MB of memory for M340), hosting of user Web pages and documents (Doc, Pdf, Excel) |                   |                      |                      |   |                      |
| <b>Predefined services</b>                  | Configuration                           | Via Web Designer software or predefined Web pages   |                   |                      |                      |   |                      |
|   | Diagnostics                             | System, rack and PLC I/O diagnostics via predefined Web pages   |                   |                      |                      |   |                      |
|   | Monitoring of variables                 | Monitoring of devices and application via animated data (read/write variables)  |                   |                      |                      |   |                      |
|   | Alarm management                        | PLCs and applications alarms monitoring via predefined Web pages  |                   |                      |                      |   |                      |
| <b>Customizable services</b>                | Graphic views                           | Graphic monitoring via animated pages (integrated graphic editor)   |                   |                      |                      |   |                      |
|   | Unity Pro operator screen               | -   |                   |                      |                      | Display in the form of Web pages  |                      |
|   | User Web pages                          | Graphic monitoring via animated Web pages created by the user   |                   |                      |                      |   |                      |
| <b>Advanced services and HMI</b>            | Calculation scripts                     | -   |                   |                      |                      | Arithmetic and logical scripts  |                      |
|   | E-mail service                          | Alarm notification by E-mail  |                   |                      |                      |   |                      |
|   | Data logging                            | -   |                   |                      |                      | Data logging in the module with time stamping (CSV files)                                     |                      |
|   | Database connection                     | -   |                   |                      |                      | Direct logging in an SQL, Oracle, MySQL database servers                                      |                      |
|   | Report service                          | -   |                   |                      |                      | Dynamic HTML report management  |                      |
|   | Recipe service                          | -   |                   |                      |                      | Management of "Recipe" data (storage and read locally or on remote database)                  |                      |
|   | PLC programme visualization by Web page | -   |                   |                      |                      | Unity Pro IEC Program Sections are visible and animated. Viewable from Windows based browsers |                      |

## Application development software

### Web Designer

Supplied with each module



| References | TSXETZ510 | BMXNOE0110 | TSXETY5103 | 140NOE77111 | TSXWMY100 | 140NWM10000 |
|------------|-----------|------------|------------|-------------|-----------|-------------|
|            |           |            |            |             |           |             |

# FactoryCast Gateway

## Web Gateways for Remote control



| Standalone Gateway, Web Server for Remote Access<br>FactoryCast Gateway ETG 10●0                               |   | FactoryCast HMI Gateway ETG30●●   |   |
|--|---|---|---|
| All equipment supporting Modbus  | All equipment supporting Uni-Telway                               | All Modicon PLCs and third-party equipment supporting Modbus  |   |
| Intranet or via external Modem, integrated RAS function  |   | Intranet or Modem<br>External modem, integrated RAS   | Intranet or Modem<br>Integrated PSTN/RTC/GSM modem and RAS modem, NAT |
| Remote programming, downloading via FTP, access to Web server via Internet browser                             |   |   |   |
| Ethernet to Modbus serial<br>Modem to Modbus serial and Ethernet   | Ethernet to Uni-Telway serial<br>Modem to Uni-Telway and Ethernet | Ethernet to Modbus serial<br>Modem to Modbus serial and Ethernet (Modbus, UNITE)  |   |
| Modbus (Master)  | Uni-Telway (Slave)  | Modbus (Master)   |   |
| Modbus TCP   | Modbus TCP, Uni-TE (Modicon Premium, Modicon TSX Micro)           | Modbus TCP<br>Uni-TE TCP  |   |
| BootP/DHCP, SNMP agent, SMTP client, NTP client, FTP   |   | DHCP, DNS, SNMP agent, SMTP client, NTP client, FTP   |   |
| Protection by IP address filtering and password  |   | Protection by IP address filtering and password + Tunnels VPN & encryption of the datas.  |   |
| HTTP and FTP server, 8 Mb memory available for user, hosting of user Web pages and documents (Doc, Pdf, Excel) |   | HTTP and FTP server, 32 Mb memory available for user Web pages, memory extension using Compact Flash cards 1 Gb max., hosting of user Web pages and documents (Doc, Pdf, Excel) |   |
| Via Web Designer software or predefined Web pages  |   |   |   |
| Diagnostics of serial devices via predefined Web pages   |   | Network diagnostics, diagnostics of serial devices and Ethernet via predefined Web pages  |   |
| Monitoring of devices and application via data tables (read/write variables)                                   |   |   |   |
| Via E-mail   |   | Via E-mail/SMS  |   |
| Graphic monitoring via animated views (integrated graphic editor)  |   |   |   |
| -  |   |   |   |
| Graphic monitoring via animated Web pages created by the user  |   |   |   |
| -  |   | Arithmetic and logical scripts  |   |
| Alarm notification by E-mail   |   | Alarm notification by E-mail/SMS  |   |
| -  |   | Data logging in the module with time stamping (CSV files)   |   |
| -  |   | Direct recording in SQL, Oracle, MySQL database servers   |   |
| -  |   | Dynamic HTML report management  |   |
| -  |   | Management of "Recipe" data (storage and revad locally or on remote database)   |   |
| -  |   | -   |   |

### Web Designer

Supplied with each module



TSXETG1000

TSXETG1010

TSXETG3000

TSXETG3010 (Modem RTC)

**TSXETG3021**  
Modem GSM/GPRS  
(Bands 900/1800MHz)  
**TSXETG3022**  
Modem GSM/GPRS  
(Bands 850/1900 MHz)

# Preventa

The Preventa range enhances safety throughout a machine's entire life cycle from design, manufacture, installation, adjustment, operation and servicing right through to decommissioning.

# 8

In addition to moral obligation and economic consequences, the law requires that machinery is safe in the interests of accident prevention. Preventa offers an extensive range of safety products, compliant with international standards, designed to provide the most comprehensive protection for personnel and equipment.

## Preventa, the safety attitude around your machine life cycle

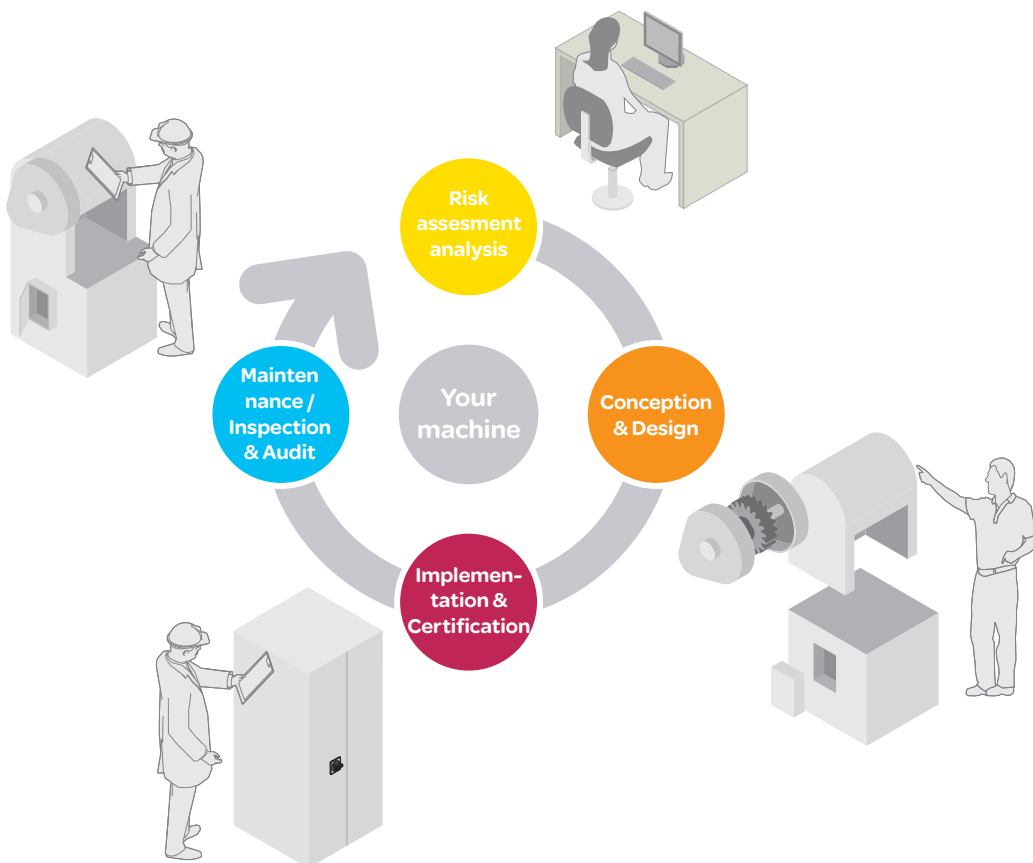



# 8 | Machine safety



## Safety standards ..... 8/2 to 8/7

## Automation ..... 8/8 to 8/12

- Safety PLCs
- Safety controllers and modules

## AS-Interface Safety at work ..... 8/13 to 8/14

- Safety monitors and interfaces

## Operator dialogue ..... 8/15 to 8/18

- Emergency stops
- Foot switches
- Control units

## Motor control ..... 8/19 to 8/21

- Switch disconnectors
- Motor starters

## > New machines - the Machinery Directive

The Machinery Directive 98/37/EC is to compel manufacturers to guarantee a minimum safety level for machinery and equipment sold within the European Union.

From 29 December 2009, the new European Machinery Directive 2006/42/EC is effective. Machines have to comply with the Essential Health and Safety Requirements (EHSRs) listed in Annex I of the Directive, thus setting a common minimum level of protection across the EEA (European Economic Area).

Machine manufacturers, or their authorised representatives within the EU, must ensure that the machine is compliant, the Technical File can be made available to the enforcing authorities on request, the CE marking is affixed, and a Declaration of Conformity has been signed, before the machine may be placed on the market within the EU.

# Why safety?



Human life is the most important value in a company!

Schneider Electric protect people and improve your productivity.

# Functional safety



«Helping you to reach easily your safety machinery and standard level required»

Thanks to directives and standards as guidelines.

# Certified safety chain solutions, designed for you by one of the leading automation companies!

## The concept:

Providing certified safety functions, on the basis of an approved combination of products and simplified schematic, to save time, reduce costs and obtain certification in accordance with the new European Machinery Directive.

## Its are made by:

- > Layout of solution indicating performance level (PL) and safety integrity level (SIL)
- > Bill of materials and the system description file
- > Example description of the PL and SIL calculation for the safety function
- > Safety conceptual principle diagram
- > Certification of all the product combination from a notify body



### Approved

- > Safety chain solutions to achieve the safety level required



### Machine Safety Expertise and Co-design

- > Worldwide support and assistance with a local engineers to help you implement machine safety solutions that meet or exceed the latest legislation and compliance with new functional machine safety standards

Motor starter (PL c, SIL 1)

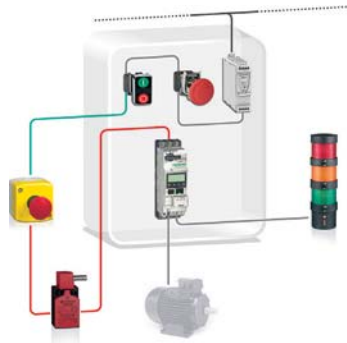

Light curtain (PL c, SIL 1)

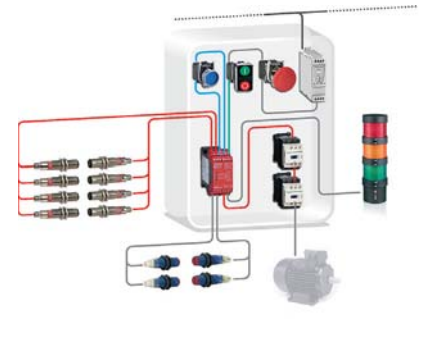

Safe stop 0 (PL d, SIL 2)

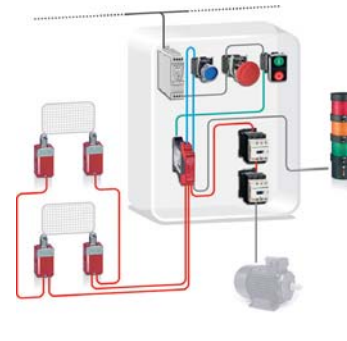

Safe stop 0 (PL e, SIL 3) High performance

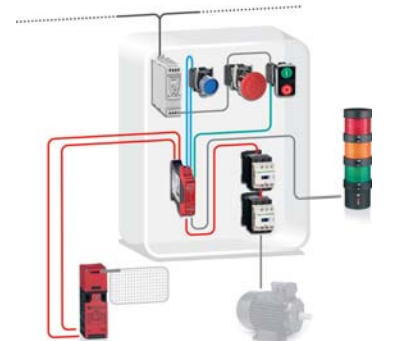



Be confident by using certified safety chain solutions provided by an automation leader

- > Save cost by avoiding external safety experts engineering
- > Reduce design time by our examples of calculation of the safety level for each safety function

Safe stop 1 (PL d, SIL 2)  
Variable speed drive



Safe stop 1 (PL e, SIL 3)  
High performance

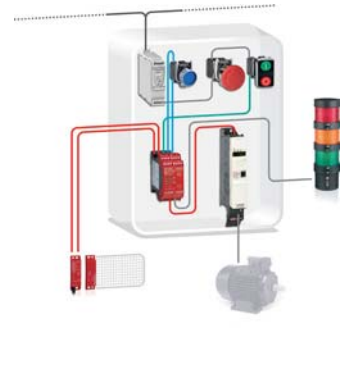

Safe stop 1 (PL e, SIL 3)  
Servo drive

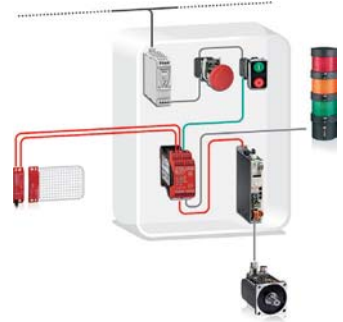

Safe stop 2 (PL e, SIL 3)  
Servo-enhanced safety

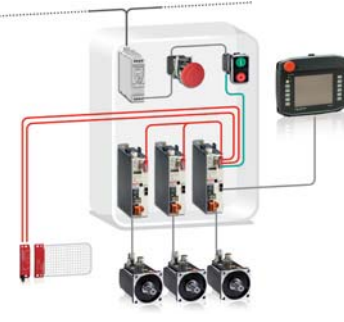

Don't wait more to implement easily the new functional standards

- > We guide you step by step on <http://www.schneider-electric.com>
- > Download our MachineSafety guide
- > Select the right safety chain
- > Evaluate the safety of your machine with Software-Assistant SISTEMA & download the Schneider Electric Preventa SISTEMA library

Safety Mat (PL d, SIL 2)

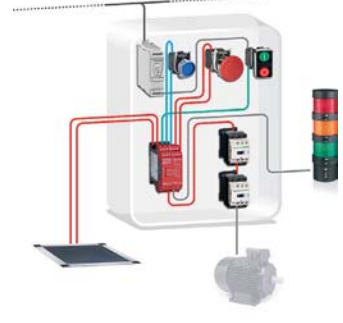

Magnetic switches (PL e, SIL 3)

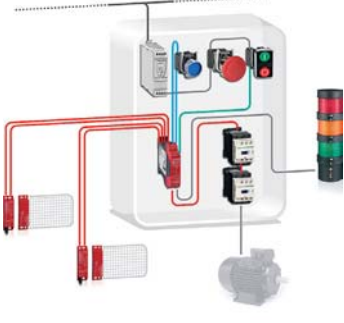

Zero speed detection (PL e, SIL 3)



Multifunction (PL e, SIL 3)

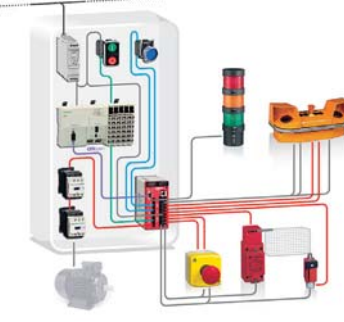

# Save cost and time with our Preventa offer

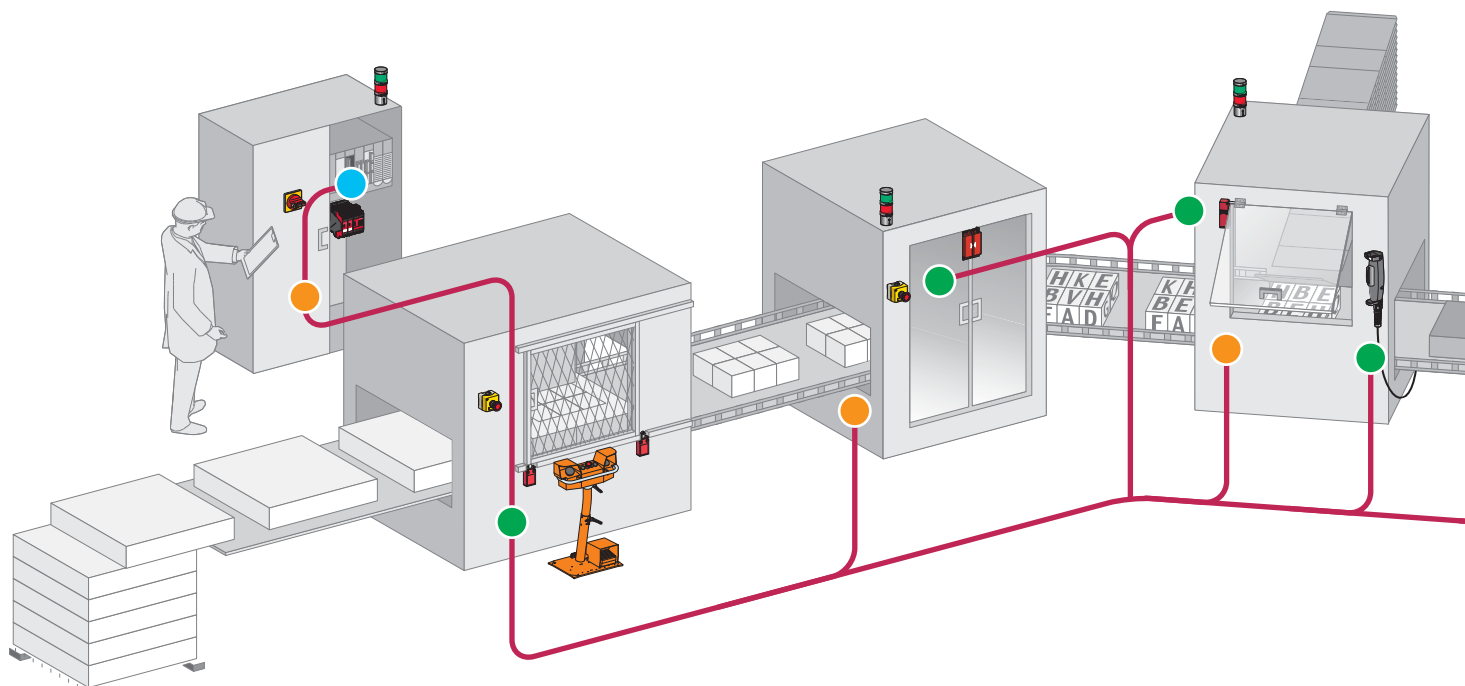

## Safe signal transmission

### Acquire the information\*:

- > Protective guard devices used as part of safeguarding systems to control the access under specific conditions of reduced risk.
- > Light curtains and safety mats to detect approach to dangerous and limited areas.
- > Two hand control stations and enabling switches for starting and enabling of dangerous movements.
- > Generic protective measures - Emergency stop.



Protective guard devices

### Monitor and processing:

- > Safety relays modules with a specific safety function to monitor input signals from safety devices and to interface with contactors and drives by switch off the output safety contacts.
- > Safety Controller: configurable safety device capable of centralized a generic range of safety monitoring functions.
- > Safety PLCs: programmable electronic systems to carry out safety or non-safety related tasks for machinery and equipment.
- > "AS-Interface safety at work": safety field bus network certified to work with safety devices to provide safety functions.



Light curtains



Safety mats



Two hand control stations and enabling switches



Emergency stop



Tripwire switch



Safety relays



Safety Controller



Safety PLCs



AS-Interface safety at work

\*For detection products please refer to The Essential Guide of Detection

8

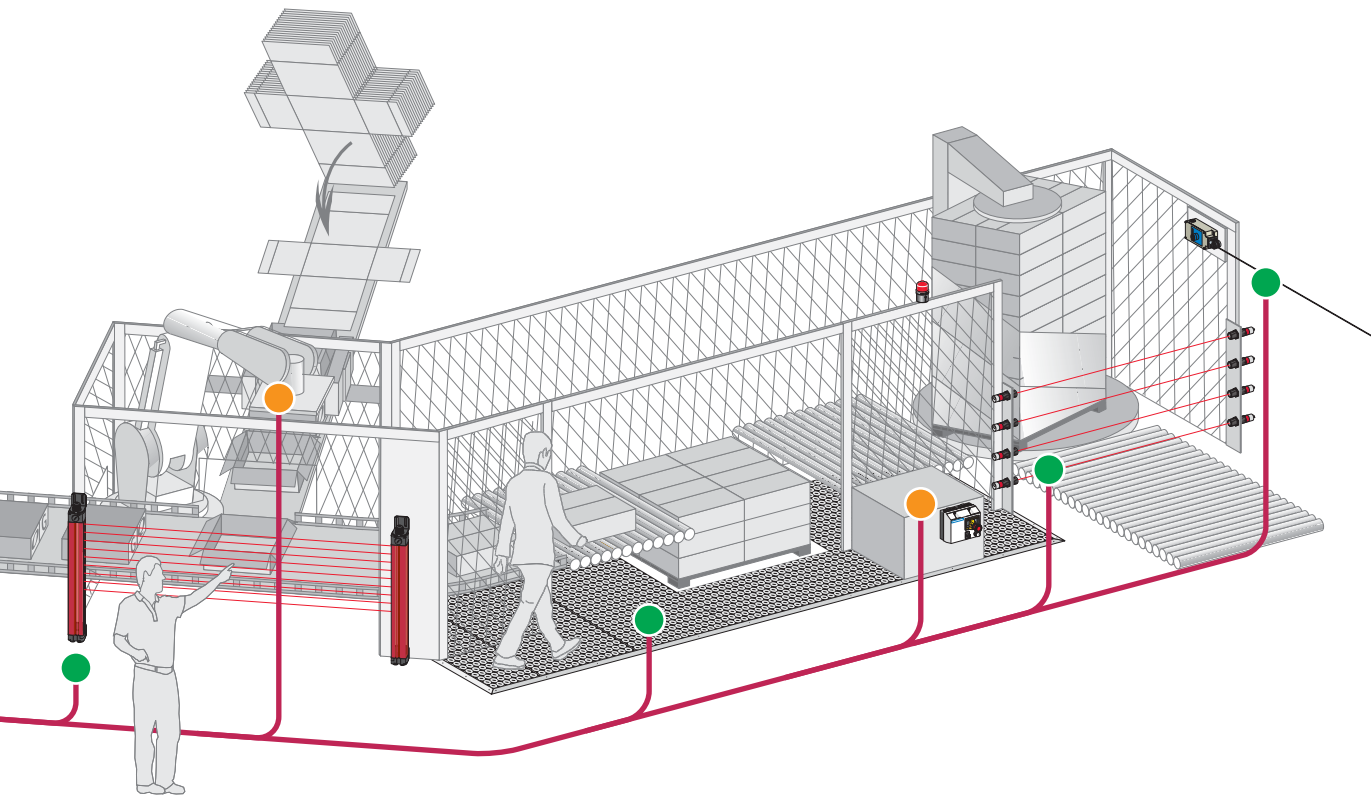

## Stop the machine:

- > Contactors to cut-off the electrical power supply to the motors with mechanically linked mirror auxiliary contacts integrated for the feedback loop diagnosis of safety modules.
- > Variable speed drives and servo drives controlled stopping of the dangerous movement by safety functions integrated.
- > Rotary switch disconnectors: for equipment isolation from the electrical supply and for emergency stop by direct interruption of the power supply.

## 1 Complete & upgraded safety offer:

Improve safety level required

## Up to 50% of space optimization

Increase the compactness by reducing size.

8



Variable Speed Drives



Servodrives



Contactors



Rotary switch disconnectors

## Save up to 30% on installation time

Reduce installation time by easy and quick wiring.

### For all XPSMF PLCs

- Maximum category of the solution ..... **Category 4**  
(EN 954-1)
- Max performance level for the solution ..... **PL e**  
(EN ISO 13849-1)
- Max safety integrity level for the solution ..... **SIL 3**  
(EN IEC 62061)



| Safety PLC type          |   | Compact  |                     |                     |                     |                     |                     |
|--------------------------|---|--|---------------------|---------------------|---------------------|---------------------|---------------------|
| Number of inputs/outputs | Digital (configurable with XPSMFWIN software)   | 24   |                     |                     |                     |                     |                     |
|                          | Pulsed (1)                                      | 2x4  |                     |                     |                     |                     |                     |
| Memory capacity          | Application                                     | 250 Kb   |                     |                     |                     |                     |                     |
|                          | Data  | 250 Kb   |                     |                     |                     |                     |                     |
| Supply                   |   | External 24 VDC supply (with separate protection conforming to IEC 61131-2)                        |                     |                     |                     |                     |                     |
| Communication            | On Ethernet network with safe Ethernet protocol | Integrated (2xRJ45)  | Integrated (2xRJ45) | Integrated (2xRJ45) | Integrated (2xRJ45) | Integrated (2xRJ45) | Integrated (2xRJ45) |
|                          | On Modbus TCP/IP                                | –  | Integrated (2xRJ45) | –                   | Integrated (2xRJ45) | –                   | Integrated (2xRJ45) |
|                          | On Modbus (Serial link)                         | –  | –                   | Integrated (1xRJ45) | Integrated (1xRJ45) | –                   | –                   |
|                          | On Profibus DP                                  | –  | –                   | –                   | –                   | Integrated (SUB-D9) | Integrated (SUB-D9) |
| Input/output connections |   | Removable screw terminal blocks or removable cage clamp terminal blocks coded with locating device |                     |                     |                     |                     |                     |
| References               |   | <b>XPSMF4000</b>   | <b>XPSMF4002</b>    | <b>XPSMF4020</b>    | <b>XPSMF4022</b>    | <b>XPSMF4040</b>    | <b>XPSMF4042</b>    |

(1) They outputs are not safety outputs.

## Compact



| Safety PLC type          |                                     | Compact   |                     |                     |                     |                     |
|--------------------------|-------------------------------------|---|---------------------|---------------------|---------------------|---------------------|
| Number of inputs         | Digital                             | 20  | 20                  | 24                  | 24                  | 24                  |
|                          | Analogue                            | –   | –                   | 8                   | 8                   | 8                   |
|                          | Counting                            | –   | –                   | 2                   | 2                   | 2                   |
| Number of outputs        | Digital                             | 8   | 8                   | 8                   | 8                   | 8                   |
|                          | Analogue                            | –   | –                   | –                   | –                   | –                   |
|                          | Relay                               | –   | –                   | –                   | –                   | –                   |
| Memory capacity          | Application                         | 250 Kb  |                     |                     |                     |                     |
|                          | Data                                | 250 Kb  |                     |                     |                     |                     |
| Supply                   |                                     | External 24 VDC supply (with separate protection conforming to IEC 61131-2) |                     |                     |                     |                     |
| Communication            | On Ethernet network (Modbus TCP/IP) | Integrated (4xRJ45)   | Integrated (4xRJ45) | Integrated (4xRJ45) | Integrated (4xRJ45) | Integrated (4xRJ45) |
|                          | On Modbus (Serial link)             | Integrated (SUB-D9)   | –                   | –                   | Integrated (SUB-D9) | –                   |
|                          | On Profibus DP                      | –   | –                   | –                   | –                   | Integrated (SUB-D9) |
| Input/output connections |                                     | Removable screw terminal blocks, coded with locating device                 |                     |                     |                     |                     |
| References (2)           |                                     | <b>XPSMF3022</b>  | <b>XPSMF31222</b>   | <b>XPSMF3502</b>    | <b>XPSMF3522</b>    | <b>XPSMF3542</b>    |

(2) Products referenced XPSMF30/MF31/MF35 are marked Himatrix F30, F31 and F35.



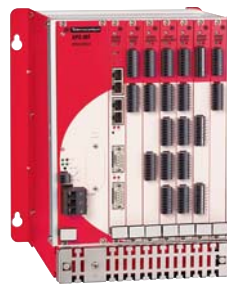

### For all XPSMF PLCs

- Maximum category of the solution ..... **Category 4**  
(EN 954-1)
- Max performance level for the solution ..... **PL e**  
(EN ISO 13849-1)
- Max safety integrity level for the solution ..... **SIL 3**  
(EN IEC 62061)

| Type                 |                                     | CPU                   | Power supply module         | Rack with 6 slots  | Software             |
|----------------------|-------------------------------------|-----------------------|-----------------------------|--------------------|----------------------|
| Memory capacity      | Application                         | 500 Kb                | –                           | –                  | For XPSMF PLCs       |
|                      | Data                                | 500 Kb                | –                           | –                  |                      |
| Supply               |                                     | –                     | External 24 VDC, integrated | –                  |                      |
| Communication        | On Ethernet network (Modbus TCP/IP) | Integrated (4xRJ45)   | –                           | –                  | Complete version     |
|                      | On Modbus bus (Serial link)         | Integrated (SUB-D9)   | –                           | –                  | <b>SSV1XPSMFWIN</b>  |
| Power connections    |                                     | Screw terminal blocks | Screw terminal blocks       | –                  | (1)                  |
| Dimensions W x D x H |                                     | –                     | –                           | 257 x 239 x 310 mm | Update version       |
| References           |                                     | <b>XPSMFCPU22</b>     | <b>XPSMFP01</b>             | <b>XPSMFGEH01</b>  | <b>SSVXPSMFWINUP</b> |



| I/O module type   |          | For modular safety PLC                                      |                   |                     |                    |                    |                       | Relay             |
|-------------------|----------|---|-------------------|---------------------|--------------------|--------------------|-----------------------|-------------------|
|                   |          | Analogue  |                   | Digital             |                    |                    |                       |                   |
| Number of inputs  | Digital  | –   | –                 | –                   | 24                 | 32                 | 24                    | –                 |
|                   | Analogue | 8   | –                 | –                   | –                  | –                  | –                     | –                 |
|                   | Counting | –   | –                 | 2                   | –                  | –                  | –                     | –                 |
| Number of outputs | Digital  | –   | –                 | 4                   | –                  | –                  | 16                    | –                 |
|                   | Analogue | –   | 8                 | –                   | –                  | –                  | –                     | –                 |
|                   | Relay    | –   | –                 | –                   | –                  | –                  | –                     | 8                 |
| Supply            |          | Removable screw terminal blocks, coded with locating device |                   |                     |                    |                    |                       |                   |
| References        |          | <b>XPSMFAI801</b>   | <b>XPSMFAO801</b> | <b>XPSMFCIO2401</b> | <b>XPSMFDI2401</b> | <b>XPSMFDI3201</b> | <b>XPSMFDIO241601</b> | <b>XPSMFD0801</b> |

### Decentralised safety I/O modules



| Module type              |  | Inputs/Ouputs Digital   |                      |                       |                       |
|--------------------------|--|---|----------------------|-----------------------|-----------------------|
| Number of inputs         | Digital                                  | 16  | 8+2                  | 16                    | 20                    |
| Number of outputs        | Digital                                  | –   | 8                    | 8                     | 8                     |
|                          | Pulsed                                   | 4   | 2                    | 2                     | –                     |
| Supply                   |  | External 24 VDC supply (with separate protection conforming to IEC 61131-2) |                      |                       |                       |
| Communication            | On Safe Ethernet network (Modbus TCP/IP) | Integrated (2xRJ45)   |                      |                       |                       |
| Input/output connections |  | Removable screw terminal blocks, coded with locating device                 |                      |                       |                       |
| References (2)           |  | <b>XPSMF1DIO1601</b>  | <b>XPSMF3DIO8801</b> | <b>XPSMF3DIO16801</b> | <b>XPSMF3DIO20802</b> |



| I/O module type          |  | Inputs/Outputs  |                    | Outputs             |                    | Relay               |
|--------------------------|--|---|--------------------|---------------------|--------------------|---------------------|
|                          |  | Analogue  | Digital            | Digital             | Relay              |                     |
| Number of inputs         | Analogue                                 | 8   | –                  | –                   | –                  | –                   |
| Number of outputs        | Digital                                  | –   | 4                  | 16                  | –                  | –                   |
|                          | Analogue (not safety)                    | 4   | –                  | –                   | –                  | –                   |
|                          | Relay                                    | –   | –                  | –                   | 8                  | 16                  |
| Supply                   |  | External 24 VDC supply (with separate protection conforming to IEC 61131-2) |                    |                     |                    |                     |
| Communication            | On Safe Ethernet network (Modbus TCP/IP) | Integrated (2xRJ45)   |                    |                     |                    |                     |
| Input/output connections |  | Removable screw terminal blocks, coded with locating device                 |                    |                     |                    |                     |
| References (2)           |  | <b>XPSMF3AIO8401</b>  | <b>XPSMF2DO401</b> | <b>XPSMF2DO1601</b> | <b>XPSMF2DO801</b> | <b>XPSMF2DO1602</b> |

(1) To be ordered only if the previous version of have been already installed.

(2) Products referenced **XPSMF1/MF2/MF3** are marked **Himatrix F1, F2 and F3**.

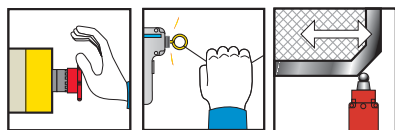

Universal



|   |            |                               |                 |                       |
|---|------------|-------------------------------|-----------------|-----------------------|
| <b>Maximum safety level of the solution attained (EN ISO 13849-1, EN/IEC 62061)</b> |            | <b>PL e / Cat. 4, SILCL 3</b> |                 |                       |
| <b>Number of circuits</b>   | Safety     | 2 x 2N/O + 6 solid-state      |                 | 2 x 3N/O per function |
|   | Additional | -                             |                 | 3 solid-state         |
| <b>Display (number of LEDs)</b>   |            | 30                            |                 | 12                    |
| <b>Width of housing</b>   |            | 74 mm                         |                 | 45 mm                 |
| <b>Communication interface</b>  |            | Modbus                        | Modbus, CANopen | Modbus, Profibus DP   |

Universal solutions: safety controllers (for monitoring several safety functions simultaneously)

|                       |        |                        |                         |                         |                       |
|-----------------------|--------|------------------------|-------------------------|-------------------------|-----------------------|
| <b>Supply voltage</b> | 24 VDC | <b>XPSMC32Z (1)(2)</b> | <b>XPSMC32ZC (1)(2)</b> | <b>XPSMC32ZP (1)(2)</b> | <b>XPSMP1123P (3)</b> |
|-----------------------|--------|------------------------|-------------------------|-------------------------|-----------------------|

## coded magnetic switches enabling switch



Universal



|   |            |                                       |                 |                       |
|---|------------|---------------------------------------|-----------------|-----------------------|
| <b>Maximum safety level of the solution attained (EN ISO 13849-1, EN/IEC 62061)</b> |            | <b>PL e / Cat. 4, SILCL 3</b>         |                 |                       |
| <b>For monitoring</b>   |            | magnetic switches and enabling switch |                 |                       |
| <b>Number of circuits</b>   | Safety     | 2 x 2N/O + 6 solid-state              |                 | 2 x 3N/O per function |
|   | Additional | -                                     |                 | 3 solid-state         |
| <b>Display (number of LEDs)</b>   |            | 30                                    |                 | 12                    |
| <b>Width of housing</b>   |            | 74 mm                                 |                 | 45 mm                 |
| <b>Communication interface</b>  |            | Modbus                                | Modbus, CANopen | Modbus, Profibus DP   |

Universal solutions: safety controllers (for monitoring several safety functions simultaneously)

|                       |        |                        |                         |                         |                       |
|-----------------------|--------|------------------------|-------------------------|-------------------------|-----------------------|
| <b>Supply voltage</b> | 24 VDC | <b>XPSMC32Z (1)(2)</b> | <b>XPSMC32ZC (1)(2)</b> | <b>XPSMC32ZP (1)(2)</b> | <b>XPSMP1123P (3)</b> |
|-----------------------|--------|------------------------|-------------------------|-------------------------|-----------------------|

## safety mats and edging



Universal



|   |            |                               |                 |                       |
|---|------------|-------------------------------|-----------------|-----------------------|
| <b>Maximum safety level of the solution attained (EN ISO 13849-1, EN/IEC 62061)</b> |            | <b>PL d / Cat. 3, SILCL 2</b> |                 |                       |
| <b>Number of circuits</b>   | Safety     | 2 x 2N/O + 6 solid-state      |                 | 2 x 3N/O per function |
|   | Additional | -                             |                 | 3 solid-state         |
| <b>Display (number of LEDs)</b>   |            | 30                            |                 | 12                    |
| <b>Width of housing</b>   |            | 74 mm                         |                 | 45 mm                 |
| <b>Communication interface</b>  |            | Modbus                        | Modbus, CANopen | Modbus, Profibus DP   |

Universal solutions: safety controllers (for monitoring several safety functions simultaneously)

|                       |        |                        |                         |                         |                       |
|-----------------------|--------|------------------------|-------------------------|-------------------------|-----------------------|
| <b>Supply voltage</b> | 24 VDC | <b>XPSMC32Z (1)(2)</b> | <b>XPSMC32ZC (1)(2)</b> | <b>XPSMC32ZP (1)(2)</b> | <b>XPSMP1123P (3)</b> |
|-----------------------|--------|------------------------|-------------------------|-------------------------|-----------------------|

(1) Version with 32 inputs. For version with 16 inputs, replace 32 in the reference by 16 (example: XPSMC32Z becomes XPSMC16Z).

(2) Configuration software XPSMCWIN (complete version) or SSVXPSMCWINUP (update version), connecting cable, adaptor and set of screw terminal plug-in connectors XPSMCTS16 and XPSMCTS32 or set of spring clip terminal plug-in connectors XPSMCTC16 and XPSMCTC32 to be ordered separately.

(3) For fixed connector version, delete the letter P from the end of the reference (example: XPSMP1123P becomes XPSMP11123).

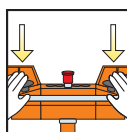

Universal



|   |            |                               |                 |                     |
|---|------------|-------------------------------|-----------------|---------------------|
| <b>Maximum safety level of the solution attained (EN ISO 13849-1, EN/IEC 62061)</b> |            | <b>PL e / Cat. 4, SILCL 3</b> |                 |                     |
| <b>Number of circuits</b>   | Safety     | 2 x 2N/O + 6 solid-state      |                 |                     |
|   | Additional | -                             |                 |                     |
| <b>Display (number of LEDs)</b>   |            | 30                            |                 |                     |
| <b>Width of housing</b>   |            | 74 mm                         |                 |                     |
| <b>Communication interface</b>  |            | Modbus                        | Modbus, CANopen | Modbus, Profibus DP |

Universal solutions: safety controllers (for monitoring several safety functions simultaneously)

|                       |        |                        |                         |                         |
|-----------------------|--------|------------------------|-------------------------|-------------------------|
| <b>Supply voltage</b> | 24 VDC | <b>XPSMC32Z (1)(2)</b> | <b>XPSMC32ZC (1)(2)</b> | <b>XPSMC32ZP (1)(2)</b> |
|-----------------------|--------|------------------------|-------------------------|-------------------------|

**light curtains**

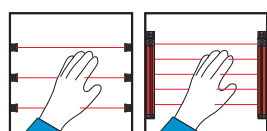

Universal



|   |            |                               |                     |                           |   |
|---|------------|-------------------------------|---------------------|---------------------------|---|
| <b>Maximum safety level of the solution attained (EN ISO 13849-1, EN/IEC 62061)</b> |            | <b>PL e / Cat. 4, SILCL 3</b> |                     |                           | <b>2 light curtains monitoring max.</b> |
| <b>Number of circuits</b>   | Safety     | 2 x 2N/O + 6 solid-state      | 2x3N/O per function | 6 PNP solid-state         |   |
|   | Additional | -                             | 3 solid-state       | 1 PNP + 1 NPN             |   |
| <b>Display (number of LEDs)</b>   |            | 30                            | 12                  | 14 + double display units |   |
| <b>Width of housing</b>   |            | 74 mm                         | 45 mm               | 100 mm                    |   |
| <b>Integral Muting function</b>   |            | Yes                           | No                  | Yes                       |   |
| <b>Communication interface</b>  |            | Modbus                        | Modbus, CANopen     | Modbus, Profibus DP       | -                                       |

Universal solutions: safety controllers (for monitoring several safety functions simultaneously)

|                       |        |                       |                        |                        |                        |                       |
|-----------------------|--------|-----------------------|------------------------|------------------------|------------------------|-----------------------|
| <b>Supply voltage</b> | 24 VDC | <b>XPSMC32Z(1)(2)</b> | <b>XPSMC32ZC(1)(2)</b> | <b>XPSMC32ZP(1)(2)</b> | <b>XPSMP11123P (3)</b> | <b>XPSLCM1150 (4)</b> |
|-----------------------|--------|-----------------------|------------------------|------------------------|------------------------|-----------------------|

(1) Version with 32 inputs, for version with 16 inputs, replace 32 in the reference by 16 (example: XPSMC32Z becomes XPSMC16Z).

(3) For version with non removable terminal block, delete the letter P from the end of the reference (example: XPSMP11123P becomes XPSMP11123).

(4) Removable terminal blocks

**zero speed, time delay**

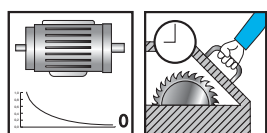

Universal



|   |            |                               |                 |                     |
|---|------------|-------------------------------|-----------------|---------------------|
| <b>Maximum safety level of the solution attained (EN ISO 13849-1, EN/IEC 62061)</b> |            | <b>PL e / Cat. 4, SILCL 3</b> |                 |                     |
| <b>For monitoring</b>   |            | Motor zero speed condition    |                 |                     |
| <b>Number of circuits</b>   | Safety     | 2 x 2N/O + 6 solid-state      |                 |                     |
|   | Additional | -                             |                 |                     |
| <b>Display (number of LEDs)</b>   |            | 30                            |                 |                     |
| <b>Width of housing</b>   |            | 74 mm                         |                 |                     |
| <b>Communication interface</b>  |            | Modbus                        | Modbus, CANopen | Modbus, Profibus DP |

Universal solutions: safety controllers (for monitoring several safety functions simultaneously)

|                       |        |                         |                          |                          |
|-----------------------|--------|-------------------------|--------------------------|--------------------------|
| <b>Supply voltage</b> | 24 VDC | <b>XPSMC32Z (5) (2)</b> | <b>XPSMC32ZC (5) (2)</b> | <b>XPSMC32ZP (5) (2)</b> |
|-----------------------|--------|-------------------------|--------------------------|--------------------------|

(2) Configuration software XPSMCWIN (complete version) or SSVXPSMCWINUP (update version), connecting cable, adaptor and set of screw terminal plug-in connectors XPSMCTS16 and XPSMCTS32 or set of spring clip terminal plug-in connectors XPSMCTC16 and XPSMCTC32 to be ordered separately.

(5) Plug-in connector version only.

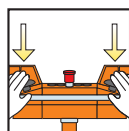

New



| Maximum safety level of the solution attained (EN ISO 13849-1, EN/IEC 62061) |            | PL c / Cat. 1<br>(type IIIA to EN 574/ISO 13851) | PL e / Cat. 4, SILCL 3<br>(type IIIC to EN 574/ISO 13851) |               |
|--|------------|--|---|---------------|
| Number of circuits   | Safety     | 1N/O   | 2N/O  | 2N/O          |
|  | Additional | 1N/C   | 1N/C  | 2 solid-state |
| Display (number of LEDs)   |            | 2  | 3   | 3             |
| Width of housing   |            | 22.5 mm  | 22.5 mm   | 22.5 mm       |

Optimum solutions: safety modules (for monitoring 1 safety function)

|                |           |           |                 |                |
|----------------|-----------|-----------|-----------------|----------------|
| Supply voltage | 24 VDC    | –         | –               | XPSBF1132P (1) |
|                | 24 VAC/DC | XPSBA5120 | XPSBCE3110P (2) | –              |

(1) For version with non removable terminal block, delete the letter P from the end of the reference (example: XPSBF1132P becomes XPSBF1132).

(2) For version with cage clamps removable terminal block, change the letter P for C from the end of the reference (example: XPSBCE3110P becomes XPSBCE3110C)

## light curtains

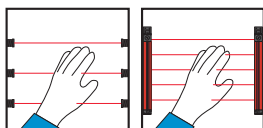

| Maximum safety level of the solution attained (EN ISO 13849-1, EN/IEC 62061) |            | PL c / Cat. 2, SILCL 1 | PL e / Cat. 4, SILCL 3 |                      |                      |
|--|------------|------------------------|------------------------|----------------------|----------------------|
| Number of circuits   | Safety     | 2N/O                   | 3N/O                   | 3N/O                 | 7N/O                 |
|  | Additional | 4 solid-state          | –                      | 1N/C + 4 solid-state | 1N/C + 4 solid-state |
| Display (number of LEDs)   |            | 4                      | 3                      | 4                    | 4                    |
| Width of housing   |            | 45 mm                  | 22.5 mm                | 45 mm                | 90 mm                |
| Integral Muting function   |            | Yes                    | No                     | No                   | No                   |

Optimum solutions: safety modules (for monitoring 1 safety function)

|                |           |                |                 |                  |                  |
|----------------|-----------|----------------|-----------------|------------------|------------------|
| Supply voltage | 24 VDC    | XPSCM1144P (1) | –               | –                | –                |
|                | 24 VAC/DC | –              | XPSAFL5130P (1) | XPSAK311144P (1) | XPSAR311144P (1) |

(1) For version with non removable terminal block, delete the letter P from the end of the reference (example: XPSCM1144P becomes XPSCM1144).

## zero speed, time delay and lifts

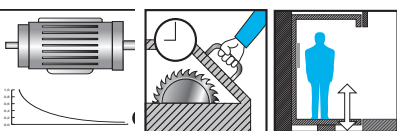

New



| Maximum safety level of the solution attained (EN ISO 13849-1, EN/IEC 62061) |            | PL d / Cat. 3, SILCL 2     |                      | PL e / Cat. 4, SILCL 3 |               |
|--|------------|----------------------------|----------------------|------------------------|---------------|
| For monitoring   |            | Motor zero speed condition | Safety time delay    |                        | Lifts         |
| Number of circuits   | Safety     | 1N/O + 1N/C                | 1N/O time delay      | 1N/O pulse             | 2N/O          |
|  | Additional | 2 solid-state              | 2N/C + 2 solid-state | 2N/C + 2 solid-state   | 2 solid-state |
| Display (number of LEDs)   |            | 4                          | 4                    | 4                      | 4             |
| Width of housing   |            | 45 mm                      | 45 mm                | 45 mm                  | 22.5 mm       |

Optimum solutions: safety modules (for monitoring 1 safety function)

|                |           |                 |                 |                 |            |
|----------------|-----------|-----------------|-----------------|-----------------|------------|
| Supply voltage | 24 VDC    | XPSVNE1142P (1) | –               | –               | –          |
|                | 24 VAC/DC | –               | XPSTSA5142P (2) | XPSTSW5142P (2) | XPSEDA5142 |

(1) Motor frequency ≤ 60 Hz.. For frequencies ≥ 60 Hz, please refer to the "Safety solution" catalogue.

(2) Removable terminal block version only.



| Maximum safety level of the solution attained (EN ISO 13849-1, EN/IEC 62061) |                    | PL e / Cat. 4, SILCL 3 |               |
|--|--------------------|------------------------|---------------|
| Number of circuits   | Safety             | 2N/O                   | 2 x 2N/O      |
|  | Auxiliary          | 1 solid-state          | 2 solid-state |
| Display (number of LEDs)   |                    | 5                      | 8             |
| Width of housing   |                    | 45 mm                  | 45 mm         |
| AS-Interface profile   |                    | S.7.F                  | S.7.F         |
| Master module compatibility  |                    | V1 / V2.1              | V1 / V2.1     |
| References of monitor with   | enhanced functions | ASISAFEMON1B           | ASISAFEMON2B  |
|  | standard functions | ASISAFEMON1            | ASISAFEMON2   |

## Configuration software, adjustment terminal and AS-Interface analyser



| Type                 | Configuration software (1)     | Adjustment terminal (2) | AS-Interface Analyser   |
|----------------------|--------------------------------|-------------------------|---|
| Multilingual         | EN / FR / DE / ES / IT / PT    | –                       | ■ Analysis and diagnostics of AS-Interface line and Safety at Work      |
| For use with         | ASISAFEMON1/2, ASISAFEMON1B/2B | –                       | ■ Complements the diagnostic functions of the local AS-Interface master |
| Media                | CD-ROM PC                      | –                       | ■ Maintenance or validation of AS-Interface lines                       |
| Environment          | Windows                        | –                       | ■ Print-out of AS-Interface line tests 92 x 28 x 139 mm                 |
| Degree of protection | –                              | IP 40                   |   |
| Supply               | –                              | 4 x LR6 batteries       |   |
| Dimensions W x D x H | –                              | 70 x 50 x 170 mm        |   |
| References           | Complete version               | ASISWIN2                | ASISA01   |
|                      | Update version (3)             | SSVASISWINUP            | –   |

(1) CD-ROM with hardware and software user guides.

(2) For addressing safety interfaces, use the infrared adaptor ASITERIR1 or the standard adaptor ASISAD1.

(3) To be ordered only if a previous version of ASISWIN have been already installed.

## Accessories

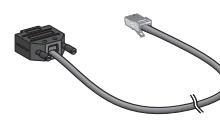

| Type                 | Adaptor for the addressing of safety interfaces | Infrared adaptor for adjustment terminal | Tap-off for AS-Interface cable | Cable for monitor parametering, RS 232 | Cable for monitor to monitor transfer |
|----------------------|---|--|--------------------------------|--|---------------------------------------|
| Degree of protection | –   | IP 67                                    | IP 67                          | IP 20                                  | IP 20                                 |
| Cable length         | –   | 1 m                                      | 2 m                            | 2 m                                    | 0.2 m                                 |
| References           | ASISAD1   | ASITERIR1                                | TCSATN01N2                     | ASISPCPC                               | ASISCM                                |



| Interface type  | For mushroom head pushbuttons |                     |                     |                     | Control stations      |                       |
|---|-------------------------------|---------------------|---------------------|---------------------|-----------------------|-----------------------|
|   | Metal                         | (1)                 | Plastic             | (1)                 | Plastic               |                       |
| Degree of protection  | IP 20                         | IP 20               | IP 20               | IP 20               | IP 65                 | IP 65                 |
| Dimensions W x D x H (mm)                                       | 40 x 90 x 68                  | 40 x 80 x 40        | 40 x 90 x 64        | 40 x 90 x 40        | 66 x 95 x 78          | 66 x 95 x 78          |
| AS-Interface profile  | S.0.B.F.F                     | S.0.B.F.F           | S.0.B.F.F           | S.0.B.F.F           | S.0.B.F.F             | S.0.B.F.F             |
| Consumption from AS-Interface                                   | 45 mA                         | 45 mA               | 45 mA               | 45 mA               | 45 mA                 | 45 mA                 |
| Infrared addressing   | Yes                           | No                  | Yes                 | No                  | No                    | No                    |
| Connection on AS-Interface                                      | IDC (2)                       | Connector           | IDC (2)             | Connector           | M12 connector         | M12 connector         |
| Reference with N/C + N/C contact (head not included)            | <b>ASISSLB4</b>               | <b>ASISSE4</b>      | <b>ASISSLB5</b>     | <b>ASISSE5</b>      | <b>ASISEA1C</b>       | <b>ASISEK1C</b>       |
| Reference of head (Ø40 latching mushroom head, turn to release) | <b>ZB4BS844</b> (3)           | <b>ZB4BS844</b> (3) | <b>ZB4AS844</b> (3) | <b>ZB5AS844</b> (3) | <b>Integrated</b> (4) | <b>Integrated</b> (5) |

(1) For installation in enclosures.

(2) IDC: Insulation Displacement Connector.

(3) Head to be ordered separately. For other heads, please refer to [www.schneider-electric.com](http://www.schneider-electric.com).

(4) Turn to release latching mushroom head.

(5) Key release (n° 455) latching mushroom head.

### For other safety products with M12 connector outputs or ISO M16/20



| Type of entry                 | 2 x M12 entries (6) | 1 x M12 entry   | 1 x ISO M16 entry (7) |
|-------------------------------|---------------------|-----------------|-----------------------|
| Degree of protection          | IP 67               | IP 67           | IP 67                 |
| Dimensions W x D x H          | 40 x 40 x 58 mm     | 40 x 40 x 58 mm | 40 x 40 x 57.5 mm     |
| AS-Interface profile          | S.0.B.F.F           | S.0.B.F.F       | S.0.B.F.F             |
| Consumption from AS-Interface | 45 mA               | 45 mA           | 45 mA                 |
| Infrared addressing           | Yes                 | Yes             | Yes                   |
| Connection on AS-Interface    | IDC (1)             | IDC (1)         | IDC (1)               |
| References                    | <b>ASISSLC2</b>     | <b>ASISSLC1</b> | <b>ASISLLS</b>        |

(6) For connection using 2 pre-wired connectors, or 1 pre-wired connector + 1 connector.

(7) For 1 x ISO M20 entry, use adaptor shown below.

### Accessories

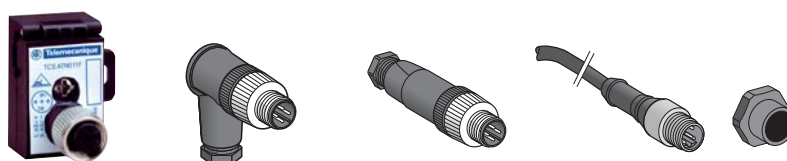

| Type                 | Tap-off for AS-Interface cable | Connectors          |                     | Pre-wired connector | Adaptor (sold in lots of 5) |
|----------------------|--------------------------------|---------------------|---------------------|---------------------|-----------------------------|
| Description          | M12 female, threaded           | elbowed             | straight            | straight            | ISO M16/M20                 |
| Degree of protection | IP 67                          | IP 67               | IP 67               | IP 67               | IP 67                       |
| Length of cable      | -                              | -                   | -                   | 2 m                 | -                           |
| References           | <b>TCSATN011F</b>              | <b>XZCC12MCM40B</b> | <b>XZCC12MDM40B</b> | <b>XZCP1541L2</b>   | <b>DE9RI2016</b>            |

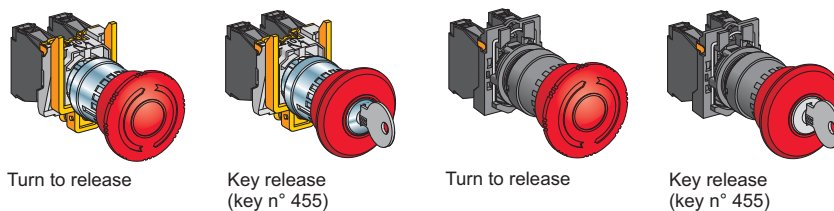
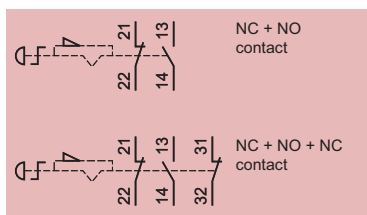

| Pushbuttons                                    | Metal  |                   | Plastic                  |                            |
|--|--|-------------------|--------------------------|----------------------------|
| Mechanical life (millions of operating cycles) | 0.3  |                   | 0.3                      |                            |
| Shock / vibration resistance                   | 10 gn / 5 gn   |                   | 10 gn / 5 gn             |                            |
| Degree of protection                           | IP 65  |                   | IP 65                    |                            |
| Rated operational characteristics              | AC 15, A 600 / DC 13, Q 600 (conforming to EN IEC 60947-5-1) |                   |                          |                            |
| Dimensions Ø x Depth                           | Ø 40 x 82 mm   |                   | Ø 40 x 81.5 mm           |                            |
| Contact  | NC + NO  | <b>XB4BS8445</b>  | <b>XB5AS8445</b>         | <b>XB5AS9445</b>           |
|  | 2 NC + 1 NO  | <b>XB4BS84441</b> | <b>ZB4BS944+ZB4BZ141</b> | <b>ZB5AS844 + ZB5AZ141</b> |
|  |  |                   | <b>ZB5AS944+ZB5AZ141</b> | <b>ZB5AS944+ZB5AZ141</b>   |



## Ø 22 trigger action latching pushbutton stations

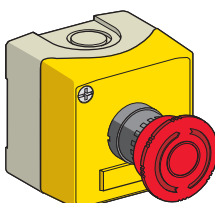
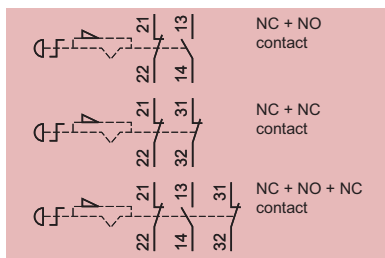

Turn to release

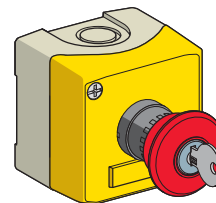

Key release (key n° 455)

| Enclosure                                      | Plastic  |                 |
|--|--|-----------------|
|  | 2 x ISO M20 cable entries or n° 13 (Pg 13.5) cable gland     |                 |
| Mechanical life (millions of operating cycles) | 0.1  |                 |
| Shock / vibration resistance                   | 10 gn / 5 gn   |                 |
| Degree of protection                           | IP 65  |                 |
| Rated operational characteristics              | AC 15, A 600 / DC 13, Q 600 (conforming to EN IEC 60947-5-1) |                 |
| Dimensions W x D x H                           | 68 x 91 x 68 mm  |                 |
| Contact  | NC + NO  | <b>XALK178E</b> |
|  | NC + NC  | <b>XALK178F</b> |
|  | 2 NC + 1 NO  | <b>XALK188G</b> |

## Accessories



With legend holder

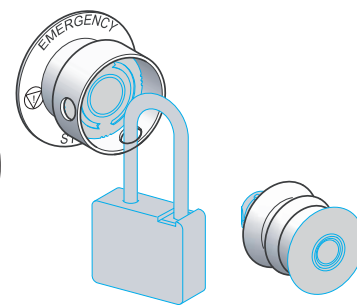

| Type       | Étiquettes               |                   | Padlocking kit | Bellows seals  |              |
|------------|--------------------------|-------------------|----------------|----------------|--------------|
| Colour     | Red with white lettering |                   | Yellow         | Red Silicone   | Black EPDM   |
| Dimensions | 30 x 40 mm (1)           |                   |                |                |              |
| Références | Marking:                 | "Arrêt d'urgence" | <b>ZBY2130</b> | <b>ZBY9130</b> | –            |
|            |                          | "Emergency stop"  | <b>ZBY2330</b> | <b>ZBY9330</b> | –            |
|            |                          | "Not Halt"        | <b>ZBY2230</b> | <b>ZBY9230</b> | –            |
|            |                          | –                 | –              | <b>ZBZ3605</b> | <b>ZBZ48</b> |
|            |                          | –                 | –              | <b>ZBZ28</b>   | <b>ZBZ28</b> |

(1) circular appearance

ISO entry  
(to EN 50262)

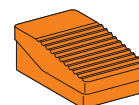
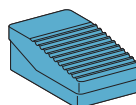
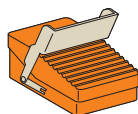

| Type   |                 | Foot switches without protective cover                       |         |         |         |
|--|-----------------|--|---------|---------|---------|
|  |                 | 2 cable entries for n° 16 (Pg 16) cable gland (1)            |         |         |         |
| Trigger mechanism                              |                 | With (positive operating action reqd.)                       | Without |         |         |
| Colour   |                 | Orange   | Blue    | Orange  |         |
| Mechanical life (millions of operating cycles) |                 | 15   |         |         |         |
| Degree of protection                           |                 | IP 66  |         |         |         |
| Shock resistance                               |                 | 100 joules   |         |         |         |
| Rated operational characteristics              |                 | AC 15, A 300 / DC 13, Q 300 (conforming to EN IEC 60947-5-1) |         |         |         |
| Dimensions W x D x H                           |                 | 104 x 172 x 59 mm  |         |         |         |
| Contact operation                              | 1 step          | 1 NC + NO  | XPER810 | XPEM110 | XPER110 |
|  |                 | 2 NC + NO  | XPER811 | XPEM111 | XPER111 |
|  | 2 step          | 2 NC + NO  | XPER911 | XPEM211 | XPER211 |
|  | Analogue output | 2 NC + NO  | XPER929 | –       | XPER229 |

(1) For entry for ISO M20 cable gland, also order adaptor DE9RA1620 (sold in lots of 5).

ISO entry  
(to EN 50262)

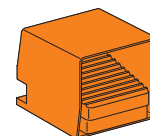
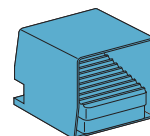
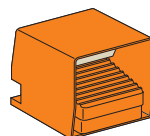
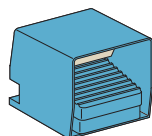

| Type   |                 | Foot switches without protective cover                       |         |         |         |
|--|-----------------|--|---------|---------|---------|
|  |                 | 2 cable entries for n° 16 (Pg 16) cable gland (1)            |         |         |         |
| Trigger mechanism                              |                 | With (positive operating action reqd.)                       | Without |         |         |
| Colour   |                 | Blue   | Orange  | Blue    | Orange  |
| Mechanical life (millions of operating cycles) |                 | 15   |         |         |         |
| Degree of protection                           |                 | IP 66  |         |         |         |
| Shock resistance                               |                 | 100 joules   |         |         |         |
| Rated operational characteristics              |                 | AC 15, A 300 / DC 13, Q 300 (conforming to EN IEC 60947-5-1) |         |         |         |
| Dimensions W x D x H                           |                 | 160 x 186 x 152 mm   |         |         |         |
| Contact operation                              | 1 step          | 1 NC + NO  | XPEM510 | XPER510 | XPEM310 |
|  |                 | 2 NC + NO  | XPEM511 | XPER511 | XPEM311 |
|  | 1 step latching | 1 NC + NO  | –       | –       | XPEM410 |
|  | 2 step          | 2 NC + NO  | XPER711 | XPER711 | XPEM611 |
|  | Analogue output | 2 NC + NO  | XPEM529 | XPER529 | XPEM329 |

(1) For entry for ISO M20 cable gland, also order adaptor DE9RA1620 (sold in lots of 5).

**Double pedal switches**

ISO entry  
(to EN 50262)

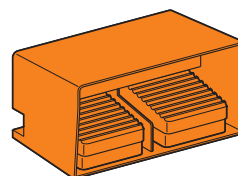
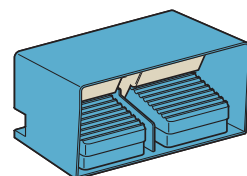

| Type   |        | Foot switches without protective cover                       |           |           |           |
|--|--------|--|-----------|-----------|-----------|
|  |        | 2 cable entries for n° 16 (Pg 16) cable gland (1)            |           |           |           |
| Trigger mechanism                              |        | With (positive operating action reqd.)                       | Without   |           |           |
| Colour   |        | Blue   | Orange    | Blue      | Orange    |
| Mechanical life (millions of operating cycles) |        | 15   |           |           |           |
| Degree of protection                           |        | IP 66  |           |           |           |
| Shock resistance                               |        | 100 joules   |           |           |           |
| Rated operational characteristics              |        | AC 15, A 300 / DC 13, Q 300 (conforming to EN IEC 60947-5-1) |           |           |           |
| Dimensions W x D x H                           |        | 295 x 190 x 155 mm   |           |           |           |
| Contact operation                              | 1 step | 2 x 1 NC + NO  | XPEM5100D | XPER510D  | XPEM3100D |
|  |        | 2 x 2 NC + NO  | XPEM5110D | XPER5110D | XPEM3110D |

(1) For entry for ISO M20 cable gland, also order adaptor DE9RA1620 (sold in lots of 5).



ISO entry  
(to EN 50262)

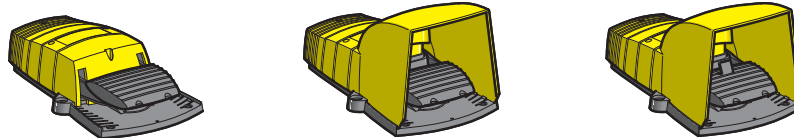

| Type   |        |           | Without protective cover                                     |         | With protective cover                  |  |
|--|--------|-----------|--|---------|--|--|
|  |        |           | 2 cable entries for ISO M20 cable gland                      |         |  |  |
| Trigger mechanism                              |        |           | Without  |         | With (positive operating action reqd.) |  |
| Colour   |        |           | Yellow   |         | Yellow                                 |  |
| Mechanical life (millions of operating cycles) |        |           | 5  |         |  |  |
| Degree of protection                           |        |           | IP 55  |         |  |  |
| Shock resistance                               |        |           | 30 joules  |         |  |  |
| Rated operational characteristics              |        |           | AC 15, A 300 / DC 13, Q 300 (conforming to EN IEC 60947-5-1) |         |  |  |
| Dimensions W x D x H                           |        |           | 160 x 280 x 70 mm  |         | 160 x 280 x 162 mm                     |  |
| Contact operation                              | 1 step | 1 NC + NO | XPEY110  | XPEY310 | XPEY510                                |  |
|  |        | 2 NC + NO | –  | XPEY311 | XPEY511                                |  |
| Contact operation                              | 2 step | 2 NC + NO | XPEY211  | XPEY611 | XPEY711                                |  |

ISO entry  
(to EN 50262)

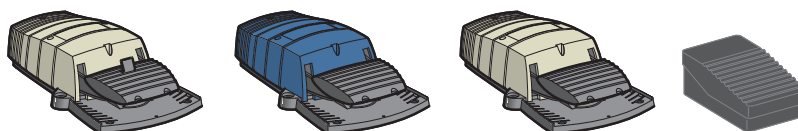

| Type   |        |           | Foot switches without protective cover                       |         |                 | 1 entry (1)      |
|--|--------|-----------|--|---------|-----------------|------------------|
|  |        |           | 2 cable entries for ISO M20 cable gland                      |         |                 |                  |
| Trigger mechanism                              |        |           | With (positive operating action reqd.)                       |         | Without         |                  |
| Colour   |        |           | Grey+  |         | Blue Grey Black |                  |
| Mechanical life (millions of operating cycles) |        |           | 10   |         | 2               |                  |
| Degree of protection                           |        |           | IP 66  |         | IP 43           |                  |
| Shock resistance                               |        |           | 100 joules   |         |                 |                  |
| Rated operational characteristics              |        |           | AC 15, A 300 / DC 13, Q 300 (conforming to EN IEC 60947-5-1) |         |                 |                  |
| Dimensions W x D x H                           |        |           | 160 x 280 x 70 mm  |         |                 | 94 x 161 x 54 mm |
| Contact operation                              | 1 step | 1 NC + NO | XPEG810  | XPEB110 | XPEG110         | XPEA110          |
|  |        | 2 NC + NO | –  | XPEB111 | XPEG111         | XPEA111          |
| Contact operation                              | 2 step | 2 NC + NO | XPEG911  | XPEB211 | XPEG211         | –                |

(1) Cable entry for ISO M16 or n° 9 (Pg 9) cable gland and for ISO M20 or n° 13 (Pg 13.5) cable gland.

ISO entry  
(to EN 50262)

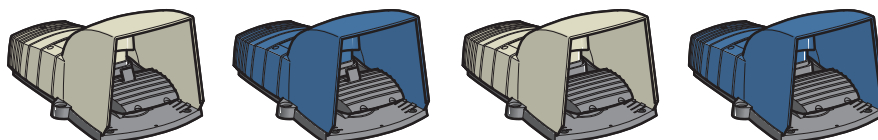

| Type   |        |           | Foot switches with protective cover                          |         |                |         |
|--|--------|-----------|--|---------|----------------|---------|
|  |        |           | 2 cable entries for ISO M20 cable gland                      |         |                |         |
| Trigger mechanism                              |        |           | With (positive operating action reqd.)                       |         | Without        |         |
| Colour   |        |           | Grey   |         | Blue Grey Blue |         |
| Mechanical life (millions of operating cycles) |        |           | 10   |         |                |         |
| Degree of protection                           |        |           | IP 66  |         |                |         |
| Shock resistance                               |        |           | 100 joules   |         |                |         |
| Rated operational characteristics              |        |           | AC 15, A 300 / DC 13, Q 300 (conforming to EN IEC 60947-5-1) |         |                |         |
| Dimensions W x D x H                           |        |           | 180 x 280 x 162 mm   |         |                |         |
| Contact operation                              | 1 step | 1 NC + NO | XPEG510  | XPEB510 | XPEG310        | XPEB310 |
|  |        | 2 NC + NO | XPEG511  | XPEB511 | XPEG311        | XPEB311 |
| Contact operation                              | 2 step | 2 NC + NO | XPEG711  | XPEB711 | XPEG611        | XPEB611 |

ISO entry  
(to EN 50262)

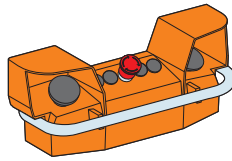

2 control pushbuttons and 1 mushroom head  
Emergency stop or Lock out pushbutton

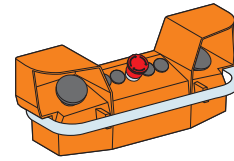

2 control pushbuttons and 1 mushroom head Emergency  
stop or Lock out pushbutton, with pre-wired terminal block

| Type   | Two-hand control stations   |             |
|--|---|-------------|
|  | 2 cable entries for ISO M20 or n° 13 (Pg 13.5) cable gland, 1 cable entry for n° 21 (Pg 21) cable gland (2) |             |
| Mechanical life (millions of operating cycles) | 1   | 1           |
| Degree of protection                           | IP 65   | IP 65       |
| Rated operational characteristics              | AC 15, A 600 / DC 13, Q 600 (conforming to EN IEC 60947-5-1)  |             |
| Dimensions W x D x H                           | 455 x 170 x 188.5 mm  |             |
| Red emergency stop (NC + NC slow break)        | XY2SB71 (1)   | XY2SB72 (1) |
| Yellow lock out (NC + NO break before make)    | XY2SB75   | XY2SB76     |

(1) To order a two-hand control station with pedestal XY2SB90, add 4 to the end of the reference (example: XY2SB71 becomes XY2SB714).

(2) For entry for ISO M25 cable gland, also order adaptor DE9RA2125 + fixing nut DE9EC21 (sold in lots of 5).

### Enabling switch

#### Contact states

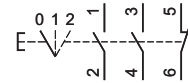
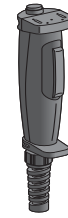
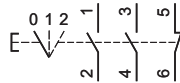
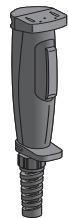
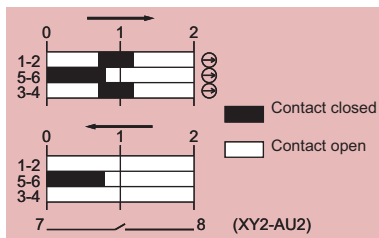

| Type                              | Plastic grip   |  |
|-----------------------------------|--|--|
|                                   | Entry for Ø 7 to 13 mm cable                               |  |
| Number of contacts                | 3  | 3  |
| Type of contacts                  | 2 NO + 1 NC  | 2 NO + 1 NC<br>1 NO auxiliary                      |
| Description                       | 3 positions  | 3 positions with button for NO contact (auxiliary) |
| Shock / vibration resistance      | 10 gn / 6 gn   |  |
| Degree of protection              | IP 66  | IP 65  |
| Rated operational characteristics | AC 15, C300 / DC 13, R300 (conforming to EN IEC 60947-5-1) |  |
| Dimensions W x D x H              | 46 x 58 x 261 mm   | 46 x 58 x 269 mm                                   |
| References                        | XY2AU1   | XY2AU2   |

For fixing accessories, please refer to [www.schneider-electric.com](http://www.schneider-electric.com).

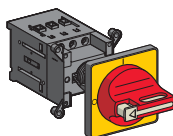
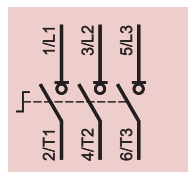

Door mounting

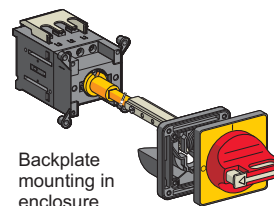

Backplate mounting in enclosure

| Type                              | Mini-Vario for standard applications |           |
|-----------------------------------|--------------------------------------|-----------|
| Front plate dimensions (mm)       | 60 x 60                              | 60 x 60   |
| Fixing                            | Ø 22.5 mm                            | Ø 22.5 mm |
| Degree of protection              | IP 20                                | IP 20     |
| Rated operational voltage (Ue)    | 690 V                                | 690 V     |
| Thermal current in open air (Ith) | 12 A                                 | VCDN12    |
|                                   | 20 A                                 | VCDN20    |

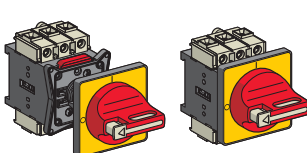
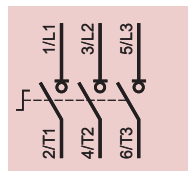

Door mounting

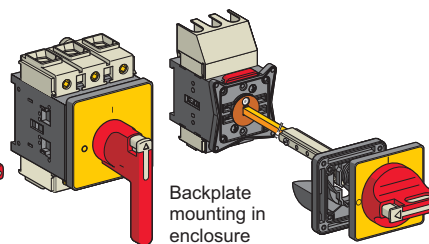

Backplate mounting in enclosure

| Type                              | Vario for high performance applications |          |          |           |          |          |
|-----------------------------------|---|----------|----------|-----------|----------|----------|
| Front plate dimensions (mm)       | 60 x 60                                 | 60 x 60  | 90 x 90  | 60 x 60   | 60 x 60  | 90 x 90  |
| Fixing                            | Ø 22.5 mm                               | 4 screws | 4 screws | Ø 22.5 mm | 4 screws | 4 screws |
| Degree of protection              | IP 20                                   | IP 20    | IP 20    | IP 20     | IP 20    | IP 20    |
| Rated operational voltage (Ue)    | 690 V                                   | 690 V    | 690 V    | 690 V     | 690 V    | 690 V    |
| Thermal current in open air (Ith) | 12 A                                    | VCD02    | VCF02    | –         | VCCD02   | VCCF02   |
|                                   | 20 A                                    | VCD01    | VCF01    | –         | VCCD01   | VCCF01   |
|                                   | 25 A                                    | VCD0     | VCF0     | –         | VCCD0    | VCCF0    |
|                                   | 32 A                                    | VCD1     | VCF1     | –         | VCCD1    | VCCF1    |
|                                   | 40 A                                    | VCD2     | VCF2     | –         | VCCD2    | VCCF2    |
|                                   | 63 A                                    | –        | VCF3     | –         | –        | VCCF3    |
|                                   | 80 A                                    | –        | VCF4     | –         | –        | VCCF4    |
|                                   | 125 A                                   | –        | –        | VCF5      | –        | –        |
|                                   | 175 A                                   | –        | –        | VCF6      | –        | –        |

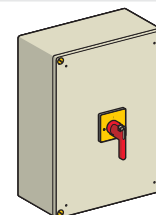
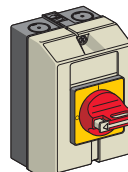
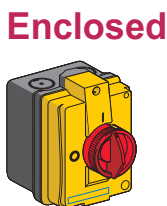
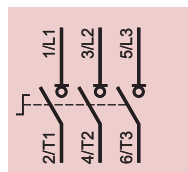

| Type                                | Mini-Vario          | Vario             |                    |
|-------------------------------------|---------------------|-------------------|--------------------|
| Front plate dimensions (mm)         | 60 x 60             | 60 x 60           | 90 x 90            |
| Dimensions W x D x H                | 82.5 x 106 x 131 mm | 90 x 131 x 146 mm | 241 x 191 x 291 mm |
| Degree of protection                | IP 55               | IP 65             | IP 65              |
| Rated operational voltage (Ue)      | 690 V               | 690 V             | 690 V              |
| Thermal current in enclosure (Ithe) | 10 A                | VCFN12GE          | VCF02GE            |
|                                     | 16 A                | VCFN20GE          | VCF01GE            |
|                                     | 20 A                | VCFN25GE          | VCF0GE             |
|                                     | 25 A                | VCFN32GE          | VCF1GE             |
|                                     | 32 A                | VCFN40GE          | VCF2GE             |
|                                     | 50 A                | –                 | VCF3GE (1)         |
|                                     | 63 A                | –                 | VCF4GE (1)         |
|                                     | 100 A               | –                 | VCF5GEN            |
|                                     | 140 A               | –                 | VCF6GEN            |

(1) Dimensions W x D x H: 150 x 152 x 170 mm.

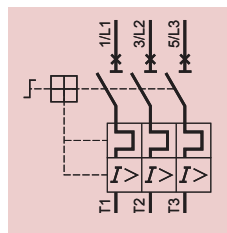

Complete circuit-breaker: circuit-breaker + enclosure + safety device.

Ex.: GV2ME01 + GV2MC02 + GV2K04.

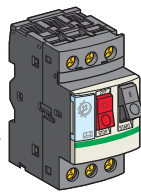

| Type                                    | Thermal-magnetic motor circuit-breakers |                |                |                |                |                |
|---|---|----------------|----------------|----------------|----------------|----------------|
| Motor power                             | kW (on 400 V)                           | –              | 0.06           | 0.09           | 0.12...0.18    | 0.25...0.37    |
| Setting range                           | A                                       | 0.1...0.16     | 0.16...0.25    | 0.25...0.40    | 0.40...0.63    | 0.63...1       |
| Current I <sub>d</sub> ± 20%            | A                                       | 1.5            | 2.4            | 5              | 8              | 13             |
| Current I <sub>the</sub> (in enclosure) | A                                       | 0.16           | 0.25           | 0.40           | 0.63           | 1              |
| Reference                               |   | <b>GV2ME01</b> | <b>GV2ME02</b> | <b>GV2ME03</b> | <b>GV2ME04</b> | <b>GV2ME05</b> |
| Motor power                             | kW (on 400 V)                           | 0.37...0.55    | 0.75           | 1.1...1.5      | 2.2            | 3...4          |
| Setting range                           | A                                       | 1...1.6        | 1.6...2.5      | 2.5...4        | 4...6.3        | 6...10         |
| Current I <sub>d</sub> ± 20%            | A                                       | 22.5           | 33.5           | 51             | 78             | 138            |
| Current I <sub>the</sub> (in enclosure) | A                                       | 1.6            | 2.5            | 4              | 6.3            | 9              |
| Reference                               |   | <b>GV2ME06</b> | <b>GV2ME07</b> | <b>GV2ME08</b> | <b>GV2ME10</b> | <b>GV2ME14</b> |
| Motor power                             | kW (on 400 V)                           | 5.5            | 7.5            | 9...11         | 11             | 15             |
| Setting range                           | A                                       | 9...14         | 13...18        | 17...23        | 20...25        | 24...32        |
| Current I <sub>d</sub> ± 20%            | A                                       | 170            | 223            | 327            | 327            | 416            |
| Current I <sub>the</sub> (in enclosure) | A                                       | 13             | 17             | 21             | 23             | 24             |
| Reference                               |   | <b>GV2ME16</b> | <b>GV2ME20</b> | <b>GV2ME21</b> | <b>GV2ME22</b> | <b>GV2ME32</b> |

## Enclosure

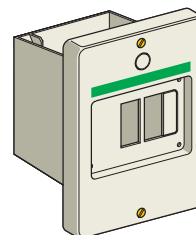
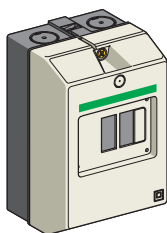

| Type                     | Empty enclosure     |                    |
|--------------------------|---------------------|--------------------|
| Mounting                 | Surface mounting    | Flush mounting     |
| Degree of protection     | IP 55               | IP 55 (front face) |
| Dimensions W x D x H (1) | 93 x 145.5 x 147 mm | 93 x 55 x 126 mm   |
| References               | <b>GV2MC02</b>      | <b>GV2MP02</b>     |

(1) Dimensions with safety device GV2K04 fitted.

## Safety device

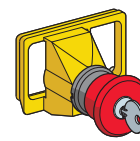
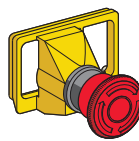
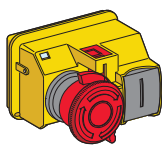

| Type                   | Safety devices                                   |                 |                             |
|------------------------|--|-----------------|-----------------------------|
| With red mushroom head | Turn to release<br>Padlockable in "Off" position | Turn to release | Key release<br>(key n° 455) |
| References             | <b>GV2K04</b>                                    | <b>GV2K031</b>  | <b>GV2K021</b>              |

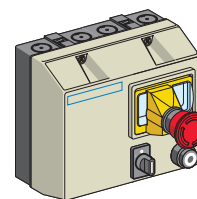
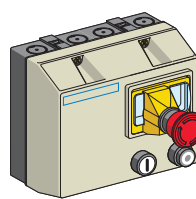
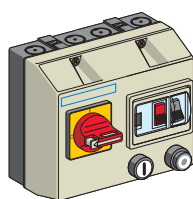

| Type  |           |       |                       | Non reversing   |            | Reversing  |
|---|-----------|-------|-----------------------|---|------------|------------|
| Degree of protection                            |           |       |                       | IP 657  |            | IP 657     |
| Standard motor power ratings (kW), category AC3 |           |       |                       | Basic reference, to be completed by code indicating voltage (1) |            |            |
| 220/230 V                                       | 400/415 V | 440 V | lth setting range (A) |   |            |            |
| –   | 0.06      | 0.06  | 0.16...0.25           | LG1K065●●02   | LG7K06●●02 | LG8K06●●02 |
| 0.06  | 0.09      | 0.12  | 0.25...0.40           | LG1K065●●03   | LG7K06●●03 | LG8K06●●03 |
| –   | 0.18      | 0.18  | 0.40...0.63           | LG1K065●●04   | LG7K06●●04 | LG8K06●●04 |
| 0.12  | 0.25      | 0.25  | 0.63...1              | LG1K065●●05   | LG7K06●●05 | LG8K06●●05 |
| 0.25  | 0.55      | 0.55  | 1...1.6               | LG1K065●●06   | LG7K06●●06 | LG8K06●●06 |
| 0.37  | 0.75      | 1.1   | 1.6...2.5             | LG1K065●●07   | LG7K06●●07 | LG8K06●●07 |
| 0.75  | 1.5       | 1.5   | 2.5...4               | LG1K065●●08   | LG7K06●●08 | LG8K06●●08 |
| 1.1   | 2.2       | 3     | 4...6.3               | LG1K065●●10   | LG7K06●●10 | LG8K06●●10 |
| 1.5   | 4         | 4     | 6...10                | LG1K095●●14   | LG7K09●●14 | LG8K09●●14 |
| 3   | 5.5       | 5.5   | 9...14                | LG1D122●●16   | LG7D12●●16 | LG8K12●●16 |
| 4   | 7.5       | 9     | 13...18               | LG1D182●●20   | LG7D18●●20 | –          |
| 4   | 9         | 9     | 17...23               | LG1D182●●21   | LG7D18●●21 | –          |

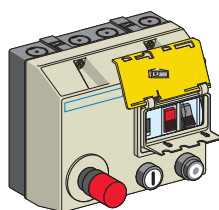

With integral control transformer, 400/24 V

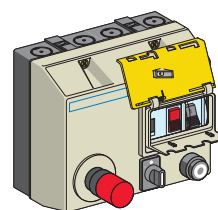

With integral control transformer, 400/24 V

| Type  |                       | Non reversing  | Reversing  |
|---|-----------------------|--|------------|
| Degree of protection                            |                       | IP 657   |            |
| Standard motor power ratings (kW), category AC3 |                       | Basic references   |            |
| 380/400 V                                       | lth setting range (A) | (The code Q7 (380/400 V) designates the power supply voltage to which the starter will be connected) |            |
| 0.06  | 0.16...0.25           | LJ7K06Q702   | LJ8K06Q702 |
| 0.09  | 0.25...0.40           | LJ7K06Q703   | LJ8K06Q703 |
| 0.18  | 0.40...0.63           | LJ7K06Q704   | LJ8K06Q704 |
| 0.25  | 0.63...1              | LJ7K06Q705   | LJ8K06Q705 |
| 0.55  | 1...1.6               | LJ7K06Q706   | LJ8K06Q706 |
| 0.75  | 1.6...2.5             | LJ7K06Q707   | LJ8K06Q707 |
| 1.5   | 2.5...4               | LJ7K06Q708   | LJ8K06Q708 |
| 2.2   | 4...6.3               | LJ7K06Q710   | LJ8K06Q710 |
| 4   | 6...10                | LJ7K09Q714   | LJ8K09Q714 |

Control circuit voltages available

| Volts 50/60 Hz   | 24 V | 230 V | 400 V | 415 V |
|------------------|------|-------|-------|-------|
| (1) Voltage code | B7   | P7    | V7    | N7    |

The control circuit must be cabled by the user.

## **Schneider Electric Industries SAS**

Head Office  
35, rue Joseph Monier - CS 30323  
F92500 Rueil-Malmaison Cedex  
France

[www.schneider-electric.com](http://www.schneider-electric.com)

The information provided in this documentation contains general descriptions and/or technical characteristics of the performance of the products contained herein. This documentation is not intended as a substitute for and is not to be used for determining suitability or reliability of these products for specific user applications. It is the duty of any such user or integrator to perform the appropriate and complete risk analysis, evaluation and testing of the products with respect to the relevant specific application or use thereof. Neither Schneider Electric nor any of its affiliates or subsidiaries shall be responsible or liable for misuse of the information contained herein.

Design : IGS-CP  
Photos : Schneider Electric  
Print :