

PacT Series

ComPacT

NSX & NSXm

Catalog 2021

Molded-Case Circuit Breakers
And Switch-Disconnectors
From 16 To 630 A - Up To 690 V





Green Premium™



More than 75% of our product sales offer superior transparency on the material content, regulatory information and environmental impact of our products:

- RoHS compliance
- REACH substance information
- Industry leading # of PEP's*
- Circularity instructions



Discover what we mean by green
Check your products!

The Green Premium program stands for our commitment to deliver customer valued sustainable performance. It has been upgraded with recognized environmental claims and extended to cover all offers including Products, Services and Solutions.

CO₂ and P&L impact through... Resource Performance

Green Premium brings improved resource efficiency throughout an asset's lifecycle. This includes efficient use of energy and natural resources, along with the minimization of CO₂ emissions.

Cost of ownership optimization through... Circular Performance

We're helping our customers optimize the total cost of ownership of their assets. To do this, we provide IoT-enabled solutions, as well as upgrade, repair, retrofit, and remanufacture services.

Peace of mind through... Well-being Performance

Green Premium products are RoHS and REACH compliant. We're going beyond regulatory compliance with step-by-step substitution of certain materials and substances from our products.

Improved sales through... Differentiation

Green Premium delivers strong value propositions through third-party labels and services. By collaborating with third-party organizations we can support our customers in meeting their sustainability goals such as green building certifications.

*PEP: Product Environmental Profile (i.e. Environmental Product Declaration)

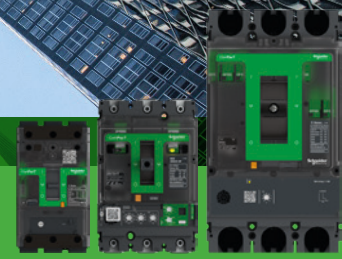

Meet the new face of connected breaker technology

70 years of innovative and reliable protection

The Schneider Electric™ Com**Pact**™ range is built on 70 years of expertise and leadership in industrial circuit breakers.







Today Schneider Electric is launching its new generation of Com**Pact** molded case circuit breakers.

The comprehensive, optimized Com**Pact** range covers your protection and has been redesigned with a superior customer experience in mind.

The range combines wireless intelligent metering and monitoring, along with advanced protective functions.

This range can be connected to Schneider Electric's open, interoperable, IoT-enabled EcoStruxure™ Power architecture. Through this platform we deliver enhanced value in terms of safety, reliability, efficiency, sustainability, and connectivity.

We leverage technologies in IoT, mobility, sensing, cloud, analytics, and cybersecurity to deliver Innovation at Every Level. This includes connected products, edge control, apps, analytics and services.

						
1952	1974	1994	2008	2017	2018	2021
Compact NW	Compact C	Compact NS	Compact NSX	Compact NSXm	Com Pact NSX & NSXm with MicroLogic Vigi	Com Pact NSX & NSXm New Generation

se.com/compact-nsx

ComPacT NSX and NSXm, even more innovative and efficient

ComPacT circuit breakers feature Schneider Electric's exclusive Roto-Active Breaking System; it reduces the effects of short circuits of your installation.

Today, the ComPacT range is optimized with a high level of breaking capacities, outstanding selectivity and cascading. It offers more advanced functions and ergonomic designs for easy installation and operations.

Eleven Performance Levels

K | HB2 | HB1 | R | L | S | H | N | F | B | E

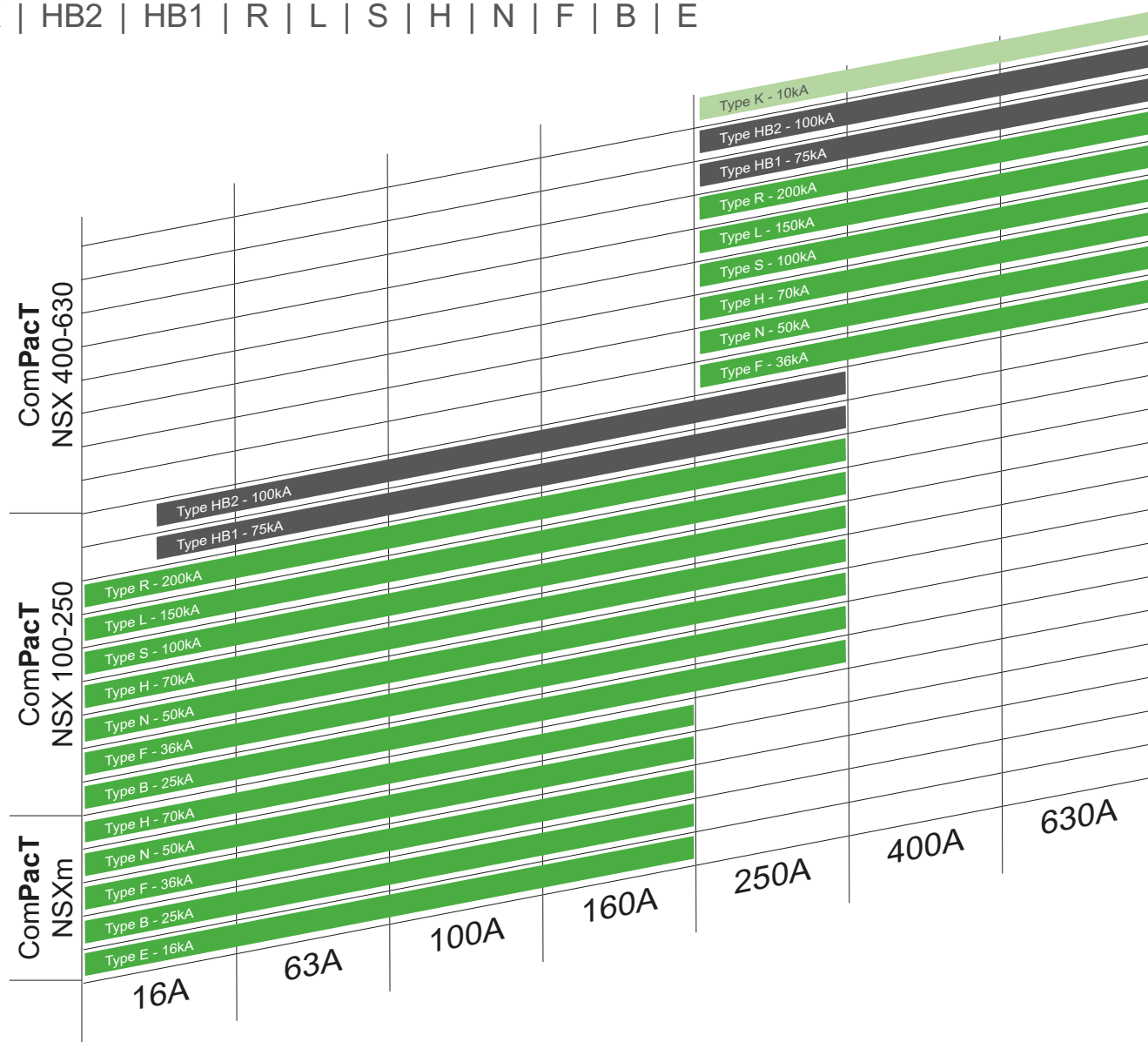

- Icu = (kA rms) at 1000V AC
- Icu = (kA rms) at 690V AC
- Icu = (kA rms) at 415V AC

Schneider Electric is proud to introduce the new generation of ComPacT MCCBs. These breakers talk to you, wherever you are, in all transparency. New design complements new wireless connectivity capabilities with our latest wireless auxiliary contact.

New

ComPacT Design



New signature design

- Schneider Electric green signature style for the entire ComPacT range
- Estimated 40% reduction of wiring time for panel builders
- Experience easier installation thanks to a new ergonomic front-plate design
- Gain the confidence that all auxiliaries are on the right spot, and simply double check that you have the right coil rating
- Ergonomic new toggle for easier breaker manual operation

New

Wireless Auxiliary Contact



Wireless breaker status

- Plug & play technology for clear connection status (0 or 1, no half-way wired)
- Placed in the same position as the wired version, its LED light will give you direct indication in case of a tripping
- If you are away, your ComPacT will send you an immediate notification via EcoStruxure Facility Expert for instance
- Wireless auxiliary accelerates overall wiring time: status communication is done very simply and commissioned wirelessly
- Communication architecture is fully EcoStruxure Power validated, with any application

Ready to meet the new face of ComPacT?



In 2021 you will meet the new generation of ComPacT™ circuit breakers with semi-transparent faceplate, screwless auxiliaries and remote monitoring features.

Learn about the benefits of the ComPacT range here:
se.com/compact-nsx

While we are launching a new generation of ComPacT breakers, we are building upon the very latest innovations that made the success of the range in the first place. The following innovations were launched recently and are still very much applicable to the new generation of ComPacT breakers.

ComPacT NSXm



Smallest size in the range

- ComPacT NSXm is the smallest frame size in the range, incorporating new features and innovations
- Gain up to 40% in space when using with integrated earth leakage protection
- Reduce up to 40% mounting and cabling time with EverLink™ connectors, built-in DIN rail and spring-type auxiliaries
- Select, configure and commission with ease, thanks to Schneider Electric online tools: EcoStruxure Customer Lifecycle Software, such as EcoStruxure Power Design – Ecodial

MicroLogic Vigi



Integrated earth leakage protection

- Easy to integrate into a row that does not have earth leakage protection
- Simple to use, reliable, and now comes in the same frame size, and for the same panel support
- Gain up to 40% in space when using with integrated earth leakage protection into the MicroLogic Vigi trip units
- Standard protection of distribution cables
- Part of the EcoStruxure Power architecture, with digital communication capability and data management (settings, measurement, pre-alarms, trip & test history)

Innovation that protects:



In 2021 you will meet the new generation of ComPacT™ circuit breakers with semi-transparent faceplate, screwless auxiliaries and remote monitoring features.

Learn about the benefits of the ComPacT NSX range here:
se.com/compact-nxs

Optimized size and innovations tailored to your needs

Roto-active™ breaking technology

While the ComPacT NSXm is the smallest breaker in the ComPacT range, it nonetheless features all the innovations from previous generations, and notably includes roto-active breaking technology. Schneider Electric was the first to introduce this technology - an innovation in which the effective fault current limitation benefits the entire installation, particularly its cables.

Reduce the effects of short circuits to extend your installation life:

- Increase life duration of all items downstream of the electrical network
- Provide both outstanding selectivity and cascading

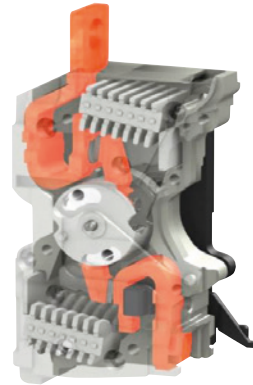

EverLink™ connectors – for enduring protection



ComPacT NSXm

The ComPacT NSXm features EverLink, an innovative cable connection method with patented creep-compensating technology that is built directly into the terminal. EverLink gives you:

- Confidence that your electrical connections maintain consistent pressure on the cable over time
- A space-saving solution as bare cable connections are as reliable as compression lug cable connections
- IP40 protection available thanks to transparent long terminal shield

Learn about EverLink online:



Scan or click on QR code

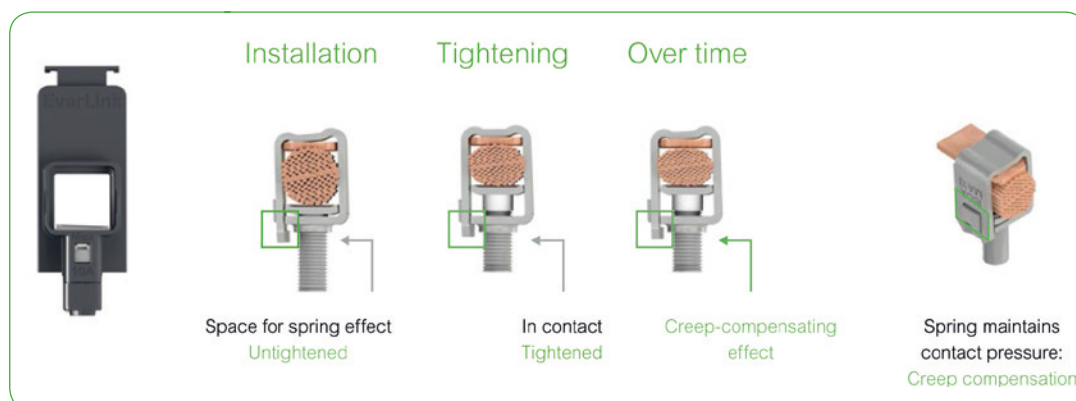



Connectivity: from corrective to predictive maintenance

As Schneider Electric's IoT-connected power supply architecture, EcoStruxure Power makes maintenance more effective, and reduces the probability and duration of blackouts. ComPacT circuit breakers play a major role in the EcoStruxure architecture, acting as watchdogs over the power supply systems, and providing data to digital architectures and monitoring software.

Corrective maintenance

EcoStruxure Power enables maintenance managers to significantly reduce power outage duration.

Example: In case of a tripped breaker, the system automatically sends email alerts. Facility managers can diagnose the incident remotely, decide upon the appropriate actions, and monitor the results.

Preventative maintenance

Enables technicians to fix issues before impacting the comfort and productivity of building occupants. This is done by:

- Sending remote warnings as soon as a creeping fault is detected, especially current leakage.
- Assisting during routine checks, ensuring all points are verified regularly and providing access to all information, including event logs, in case of suspected weakness.

The available information enables preventive maintenance based on wear-out indications and warnings sent via the digital system.

Predictive maintenance

Data collected across the power distribution network, stored and computed by Schneider Electric analytics, provides greater insight for improved long-term planning and life-cycle management. Furthermore, advanced data processing enables predictive maintenance.

Example: By analyzing historical data and monitoring load profiles, maintenance and upgrades can be scheduled efficiently.



Learn about connectivity online:



Scan or click on QR code



EcoStruxure Power connected products

Embrace an open partner ecosystem

Today's value chain in electrical distribution is highly fragmented and inefficient from design to maintenance.

With EcoStruxure Power solutions, Schneider Electric strengthens and simplifies the entire project path by shaping a unique ecosystem of specifiers, contractors, panel builders, integrators, distributors and facility managers serving end users.

450,000+

EcoStruxure installations

1 billion

connected devices

For these electrical distribution professionals, EcoStruxure Power provides opportunities to broaden and improve the services they offer their customers.

- A comprehensive and innovative range of IoT-enabled LV and MV offers
- Proven, interoperable reference architectures for any building or business
- Design, selection, commissioning and configuration tools to enhance deployment efficiencies across the project life cycle

Apps, Analytics & Services



Actionable predictive maintenance information that helps protect your customers, safeguard your reputation and minimize financial impact.

Edge Control



Track maintenance activity to reduce downtime, energy use, and maintenance costs while improving site planning and revealing additional capacity.

Connected Products



IoT-enabled low and medium voltage offers to seamlessly fit into EcoStruxure architectures.

Contribute to a better world. Enhance sustainability with ComPacT range

Achieve Green Building certification with Green Premium ecolabel

In compliance with ISO 14025 PEP ecopassport program, we publish a comprehensive Life Cycle Analysis of our product, providing the environmental data you need to achieve Green Building certifications.

For example, ComPacT NSX & NSXm contribute to 3 LEED™ points in the Building Product Disclosure and Optimization section:

- Environmental Product Declaration
- Material Ingredients



ComPacT NSX range is now enriched with the new ComPacT NSXm, designed according to the EcoDesign Way™ by Schneider. It now features new space saving frame size for reduced resource consumption, and more.



New Packaging

- The ComPacT range comes in plastic-less packaging: not only to reduce our carbon footprint, but it also means less waste in the workshop
- Simplified instruction sheets included in all packaging
- 100% recycled carton
- Scan QR codes for access to digital documentation
- This product is REACH and RoHS compliant



New generation, simpler commercial references

New meaningful references to make your life easier

We know any change in commercial references will be an adjustment, but in the long run we believe this change is needed, and will make your life easier.

Type (1)	Frame rating (2)	Breaking capacity (1)	Num Poles (2)	Trip Unit (2)	Trip Unit Ratings (3)	Suffix (1)
NSX = C	100m = 11	16kA = E	1P = 1	TMD = TM	16 = 016	EverLink = L
NSXm = C	160m = 12	25kA = B	2P = 2	MA = MA	20 = 020	Busbar = B
	100 = 10	36kA = F	3P3D = 3	TMG = MG	25 = 025	Fixed = F
	160 = 16	50kA = N	4P4D = 4	1.3 M = 1M	30 = 030	DC = D
	250 = 25	70kA = H	3P2D = 5	2.2 = 2D	40 = 040	Switch = S
	400 = 40	100kA = S	4P3D = 6	2.3 = 2D	50 = 050	DC PV = DP
	630 = 63	150kA = L		4.1 = 4V	63 = 063	
		...		4.2 = 4V	80 = 080	Acc with ID
				...	100 = 100	change = T
					...	

For instance LV429630 will become C10F3TM100
Com**PacT** Breaker NSX100F 36kA AC 3P3D 100A TMD

Scan QR code for breaker updates

Each breaker is equipped with a QR code that allows you to get the latest information on your breaker.



Simpler names for our offers

We are making it easier for you to navigate across the wide range of our world-class digital offerings and select with confidence the offers that are right for you and your needs.

EcoStruxure Architecture

To enable brand consistency, relevance and impact, we are reinforcing our EcoStruxure™ architecture and digital customer lifecycle tools to ensure a seamless experience from the CAPEX to OPEX phases of each project, bridging our entire ecosystem of partners, services providers and end users.

EcoStruxure is our IoT-enabled open and interoperable system architecture and platform. EcoStruxure delivers enhanced values around safety, reliability, efficiency, sustainability and connectivity for our customers. EcoStruxure leverages advancements in IoT, mobility, sensing, cloud, analytics, and cybersecurity technologies to deliver Innovation At Every Level from Connected Products; Edge Control; and Apps, Analytics & Services: our IoT technology Levels.

Old names	New names
Ecodial	EcoStruxure Power Design
Ecoreal	EcoStruxure Power Build
Ecoreach	EcoStruxure Power Commission
Masterpact MTZ mobile App	EcoStruxure Power Device App

Pact Series

Future-proof your installation with Schneider Electric's low and medium voltage **PacT** Series. Built on legendary Schneider Electric innovation, the **PacT** Series comprises world-class circuit breakers, switches, residual current devices and fuses, for all standard and specific applications. Experience robust performance with this comprehensive range of EcoStruxure- ready switchgear, for all applications from 16 to 6300 A.

Old names	New names
Compact	Com PacT
Masterpact	Master PacT
Micrologic	Micro Logic
Transferpact	Transfer PacT
Fupact	Fu PacT

General contents

ComPacT NSXm & NSX

Presentation

Select Circuit Breakers and Switch-Disconnectors

Select Protection

Customize Circuit Breakers with Accessories

Smart Panel Integration

Switchboard Integration

Catalog Numbers

Glossary

Additional Characteristics

A

B

C

D

E

F

G

H

ComPacT NSXm & NSX

Application Overview

The ComPacT NSX and NSXm circuit breakers and switch-disconnectors are the best choice for all standards and specific applications.

ComPacT™ NSX & NSXm

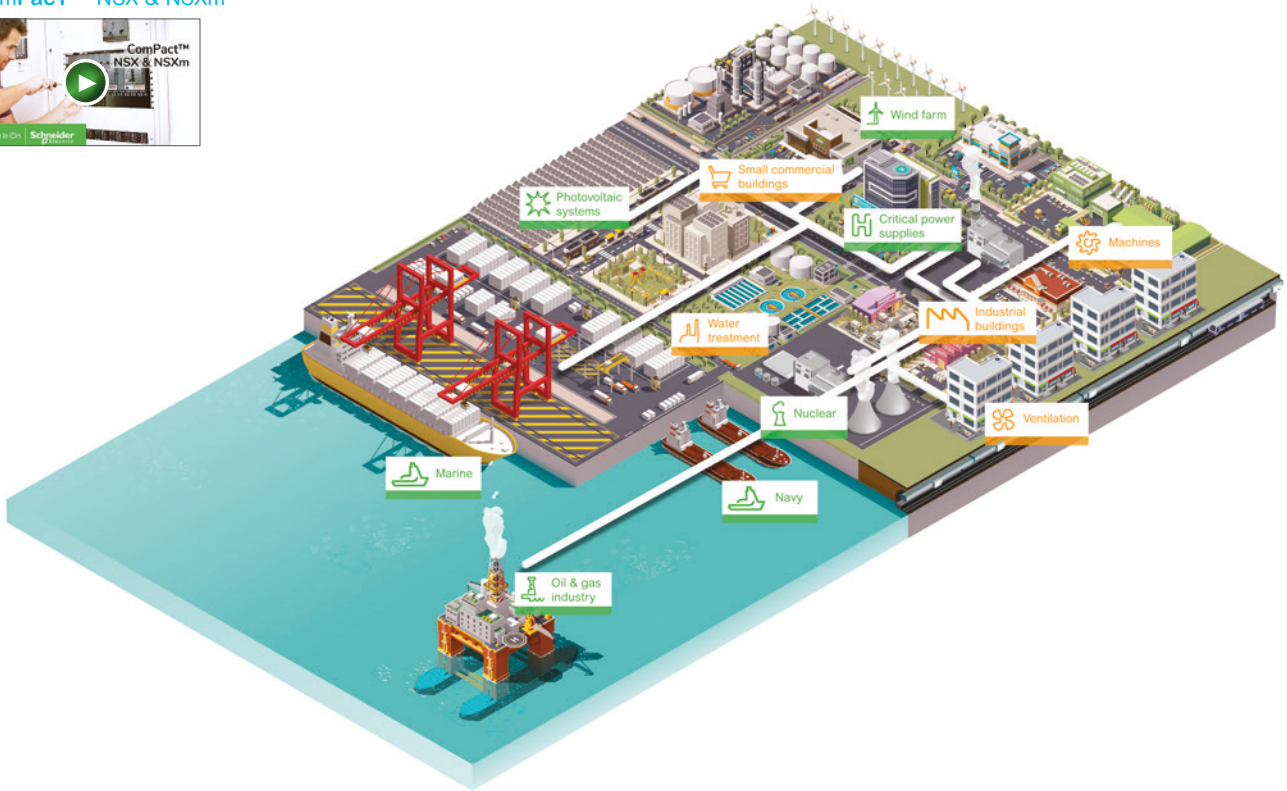

> ComPacT INS/INV [a]



LVPED213024EN

> FuPacT [a]



LVPED216031EN

> Substitution and Technical Guide ComPacT NSX High Performances [b]



LVPED508025EN

> ComPacT NSX, ComPacT INS/INV, MasterPact NW DC - DC PV - DC EP [c]



LVPED221002EN

> TransferPacT (Source-changeover systems) [d]



LVPED216028EN

> Complementary technical information



LVPED318033EN

ComPacT NSXm & NSX

Application Overview

Buildings

ComPacT NSXm devices up to 160 A (70 kA/415 V) are equipped with thermal magnetic trip units.

ComPacT NSX devices up to 630A (200 kA/415 V) are equipped with Magnetic, Thermal Magnetic, basic electronic trip units (MicroLogic 2) and advanced electronic trip units (MicroLogic 5/6) which offer embedded metering and communication.

Both devices can protect against insulation faults thanks to their embedded earth leakage protection.

ComPacT NSXm and NSX can be easily installed at all levels in distribution systems, from main LV switchboard to the subdistribution boards and enclosures.

Industrial Buildings, Machines, Ventilation and Water Treatment

The ComPacT NSX range includes a number of versions to protect motor applications:

- Basic short-circuit protection with MA magnetic trip units or the electronic MicroLogic 1-M version, combined with an external relay to provide thermal protection.
- Protection against overloads, short-circuits with additional motor-specific protection (phase unbalance, locked rotor, underload and long start) with MicroLogic 6 E-M trip units.

These versions also offer communication, metering and operating assistance.

The exceptional limiting capacity of ComPacT NSX circuit breakers automatically provides type-2 coordination with the motor starter, in compliance with standard IEC 60947-4-1.

Buildings and Industrial Buildings

A switch-disconnector version of ComPacT NSXm and NSX circuit breakers is available for circuit control and isolation. All add-on functions of both circuit breakers may be combine with the basic switch-disconnector function.

For information on other switch-disconnector ranges, see the ComPacT INS/INV catalog and for fusegear protection see FuPacT catalog [a].

Marine

ComPacT NSX HB1/HB2 up to 630 A circuit breakers have the best-in-class breaking capacity for Marine applications (100 kA/690 V).

Devices can be equipped with thermal magnetic, basic electronic trip units (MicroLogic 2) and advanced electronic trip units (MicroLogic 5/6) which offer embedded metering and communication.

Standard ComPacT NSX breakers AC and DC ranges can be used for military navy inside the main and emergency switchboards [b].

Special Applications

The ComPacT NSX range offers a number of versions for special protection applications:

- Service connection to public distribution systems
- Generators
- Industrial control panels
- 16 Hz 2/3 systems
- 400 Hz systems [1]

For all these applications, circuit breakers in the ComPacT NSX range offer positive contact indication and are suitable for isolation in accordance with standards IEC 60947-1 and 2.

[1] ComPacT NSXm may be used on 400 Hz systems.

Photovoltaic

ComPacT NSX DC PV range up to 500 A (1000V DC), and range from 250 A to 400 A (800 to 1000 V AC), equipped with electronic trip unit MicroLogic 2 is the appropriate choice for photovoltaic generation from 10 kW to 500 kW.

Circuit breakers can be used for over-current protection.

Circuit breakers and switches can be used for isolation during maintenance phase.

ComPacT NSX is part of a Schneider Electric photovoltaic architecture which offers AC and DC protection, control and metering, inverters for DC to AC voltages and PV modules [c].

Oil and Gas

ComPacT NSX up to 630 A offers the Highest breaking capacity in its class mainly required in Oil and Gas industry:

- Up to 100 kA at 690 V
- Up to 200 kA at 415 V

Devices can be equipped with thermal magnetic, basic electronic trip units (MicroLogic 2) and advanced electronic trip units (MicroLogic 5/6) which offer embedded metering and communication

ComPacT NSX range offers outstanding selectivity at 415 V and 690 V [b].

Critical Power Supplies

ComPacT NSX DC range up to 1200 A (5 kA/600 V DC) meets the requirements of UPS manufacturers keeping the same compact footprint as the standard ComPacT NSX range.

Batteries are usually used for emergency power supply and circuit breakers are used to protect the battery circuit (between the battery and the circuit) [c].

To allow a continuous supply of power, some electrical installations are connected to two power sources [d]:

- A normal source.
- A replacement source to supply the installation when the normal source is not available.

A mechanical and/or electrical interlocking system between two circuit breakers or switch-disconnectors avoids all risk of parallel connection of the sources during switching.

A source-changeover system can be:

- Manual with mechanical device interlocking
- Remote controlled with mechanical and/or electrical device interlocking
- Automatic by adding a controller to manage switching from one source to the other on the basis of external parameters



Select Circuit Breakers and Switch-Disconnectors

Characteristics and Performance

ComPacT NSXm Circuit Breakers from 16 to 160 A up to 690 V... A-2

ComPacT NSX Circuit Breakers from 100 to 250 A up to 690 V.... A-4

ComPacT NSX Circuit Breakers from 400 to 630 A up to 690 V.... A-8

ComPacT NSXm Switch-Disconnectors from 50 to 160 A NA..... A-10

ComPacT NSX Switch-Disconnectors from 100 to 630 A NA..... A-12

General Characteristics of the ComPacT Range

ComPacT NSX Special Applications

High Performances at 690 V A-16



Other Chapters

Select Protection	B-1
Customize Circuit Breakers with Accessories.....	C-1
Smart Panel Integration	D-1
Switchboard Integration.....	E-1
Catalog Numbers	F-1
Glossary	G-1
Additional Characteristics.....	H-1

Characteristics and Performance

ComPacT NSXm Circuit Breakers from 16 to 160 A up to 690 V

ComPacT™ NSXm Molded Case Circuit Breaker (MCCB)

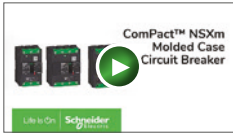

A

C12H3TM160L-eps



ComPacT NSXm

Common Characteristics

Rated voltages	Insulation voltage (V)	Ui	800
	Insulation voltage for ELCB [1] (V)	Ui	500
	Impulse withstand voltage (kV)	Uimp	8
	Operational voltage (V)	Ue AC 50/60 Hz	690
	Operational voltage for ELCB [1] (V)	Ue AC 50/60 Hz	440
Suitability for isolation	IEC/EN 60947-2		yes
Utilization category			A
Pollution degree	IEC 60664-1		3

Circuit Breakers

Breaking Capacity Levels

Breaking capacity (kA rms)

Icu	AC 50/60 Hz	220...240 V
		380...415 V
		440 V
		500 V
		525 V
		660...690 V

Service breaking capacity (kA rms)

Ics	AC 50/60 Hz	220...240 V
		380...415 V
		440 V
		500 V
		525 V
		660...690 V

Durability (C-O cycles)	Mechanical		
		Electrical	440 V
		690 V	In/2
			In

Protection and Measurements

Overload/short-circuit protection	Thermal magnetic
	Electronic with Earth Leakage Protection (ELCB)
Options	Device status/control
	For ELCB [1]: alarming and fault differentiation

Installation/Connections

Dimensions and weights

Dimensions (mm)	3P
W x H x D	4P
	ELCB [1]
Weight (kg)	3P
	4P
	ELCB [1]

Connections

Pitch (mm)	Standard	
	With spreaders	
EverLink lug Cu or Al [2] cables	Cross-section (mm ²)	Rigid
		Flexible
Crimp lugs Cu or Al	Cross-section (mm ²)	Rigid
		Flexible

Source Changeover System

Manual mechanical interlocking

[1] ELCB: Earth Leakage Circuit Breaker (MicroLogic Vigi 4.1).

[2] Al up to 100 A.

Characteristics and Performance

ComPacT NSXm Circuit Breakers from 16 to 160 A up to 690 V



Common Characteristics			
Control	Manual	With toggle	<input checked="" type="radio"/>
		With direct or extended rotary handle	<input checked="" type="radio"/>
		With side rotary handle	<input checked="" type="radio"/>
Versions	Fixed		<input checked="" type="radio"/>

NSXm up to 63 A						NSXm from 80 to 160 A and ELCB [1]				
E	B	F	N	H		E	B	F	N	H
25	50	85	90	100		25	50	85	90	100
16	25	36	50	70		16	25	36	50	70
10	20	35	50	65		10	20	35	50	65
8	10	15	25	30		-	-	-	-	-
-	-	10	15	22		-	-	-	-	-
-	-	-	10	10		-	-	-	-	-
25	50	85	90	100		25	50	85	90	100
16	25	36	50	70		16	25	36	50	70
10	20	30	50	65		10	20	30	50	65
8	10	10	25	30		-	-	-	-	-
-	-	10	15	22		-	-	-	-	-
-	-	-	2.5	2.5		-	-	-	-	-
20000										
20000										
10000										
10000										
5000										
<input checked="" type="radio"/>						<input checked="" type="radio"/>				
<input checked="" type="radio"/>						<input checked="" type="radio"/>				
<input checked="" type="radio"/>										
81 x 137 x 80										
108 x 137 x 80										
108 x 144 x 80										
1.06										
1.42										
1.63										
27										
35										
95										
70										
120										
95										
<input checked="" type="radio"/>						<input checked="" type="radio"/>				

Characteristics and Performance

ComPacT NSX Circuit Breakers from 100 to 250 A up to 690 V

A



ComPacT NSX single-pole



ComPacT NSX two-pole

ComPacT Circuit Breakers

Number of poles		
Control	Manual	toggle
		direct or extended rotary handle
	Electric	
Connections	Fixed	front connection
		rear connection
	Withdrawable	front connection
		rear connection

Electrical Characteristics IEC/EN 60947-2

Rated current (A)	In	40 °C
Rated insulation voltage (V)	Ui	
Rated impulse withstand voltage (kV)	Uimp	
Rated operational voltage (V)	Ue	AC 50/60 Hz DC

Type of Circuit Breaker

Ultimate breaking capacity (kA rms)	Icu	AC	220/240 V
		50/60 Hz	380/415 V 440 V 500/525 V 660/690 V
Service breaking capacity (kA rms)	Ics	DC	250 V (1P) 500 V (2P)
			% Icu

Suitability for isolation

Utilization category			
Durability (C-O cycles)	Mechanical		
	Electrical	277 V	In/2 In

Protection and Measurements

Type of trip units			
Ratings		In	
Overload protection (thermal)	Long time threshold	Ir	
	Short-circuit protection (magnetic)	Instantaneous pickup	Ii value indicated for AC ^[1] real value for DC
Add-on earth-leakage protection	VigiPacT add-on combination with VigiPacT relay		

Additional Indication and Control Auxiliaries

Indication contacts	
Voltage releases	MX shunt release
	MN undervoltage release

Installation

Accessories	Terminal extensions and spreaders
	Terminal shields and interphase barriers
	Escutcheons
Dimensions (mm)	W x H x D
Weight (kg)	

Source Changeover System

Manual mechanical interlocking

[1] The thresholds for TMD and TMG 1-pole and 2-pole magnetic trip units up to 63 A are indicated for AC. The real DC thresholds are indicated on the following line.

Characteristics and Performance

ComPacT NSX Circuit Breakers from 100 to 250 A up to 690 V



NSX100					NSX160					NSX250														
1					2					1					2					1				
⊙					⊙					⊙					⊙					⊙				
-					-					-					-					-				
-					-					-					-					-				
⊙					⊙					⊙					⊙					⊙				
⊙					⊙					⊙					⊙					⊙				
-					-					-					-					-				
-					-					-					-					-				
100					100					160					160					250				
750					750					750					750					750				
8					8					8					8					8				
277					690					277					690					277				
250					500					250					500					-				
F N M					F M S					F N M				F M S					N					
18 25 40					36 85 100					18 25 40				36 85 100					25					
- - -					18 25 70					- - -				18 25 70					-					
- - -					15 25 65					- - -				15 25 65					-					
- - -					10 18 35					- - -				10 18 35					-					
- - -					5 8 10					- - -				5 8 10					-					
36 50 85					36 85 100					36 50 85				36 85 100					-					
- - -					36 85 100					- - -				36 85 100					-					
100 %					100 %					100 %				100 %					100 %					
⊙					⊙					⊙				⊙					⊙					
A					A					A				A					A					
20000					20000					20000				20000					10000					
20000					20000					20000				20000					10000					
10000					10000					10000				10000					5000					
built-in thermal-magnetic					built-in thermal-magnetic					built-in thermal-magnetic				built-in thermal-magnetic					built-in thermal-magnetic					
16 20 25 30 40					50 63 80 100					125 160				160 200 250					160 200 250					
fixed					fixed					fixed				fixed					fixed					
16 20 25 30 40					50 63 80 100					125 160				160 200 250					160 200 250					
fixed					fixed					fixed				fixed					fixed					
190 190 300 300 500					500 500 640 800					1000 1250				850 850 850					850 850 850					
260 260 400 400 700					700 700 800 1000					1200 1250				- - -					- - -					
-					-					-				-					-					
-					⊙					-				⊙					-					
-					⊙					-				⊙					-					
-					⊙					-				⊙					-					
⊙					⊙					⊙				⊙					⊙					
⊙					⊙					⊙				⊙					⊙					
⊙					⊙					⊙				⊙					⊙					
35 x 161 x 86					70 x 161 x 86					35 x 161 x 86				70 x 161 x 86					35 x 161 x 86					
0.7					1.2					0.7				1.2					0.7					
⊙					⊙					⊙				⊙					⊙					

Characteristics and Performance

ComPacT NSX Circuit Breakers from 100 to 250 A up to 690 V

ComPacT NSX[®] MCCB from "Schneider Electric"



A



ComPacT NSX250 HB2

Common Characteristics

Rated voltages	Insulation voltage (V)	Ui	800
	Insulation voltage for ELCB [6]	Ui	500
	Impulse withstand voltage (kV)	Uimp	8
	Operational voltage (V)	Ue	AC 50/60 Hz 690
	Operation voltage for ELCB [6]	Ue	AC 50/60 Hz 440
Suitability for isolation		IEC/EN 60947-2	yes
Utilization category			A
Pollution degree		IEC 60664-1	3

Circuit Breakers

Breaking Capacity Levels

Electrical characteristics as per IEC/EN 60947-2

Rated current (A)	In	40 °C
-------------------	----	-------

Number of poles

Breaking capacity (kA rms)

	Icu	AC 50/60 Hz	220/240 V
			380/415 V
			440 V
			500 V
			525 V
			660/690 V

Service breaking capacity (kA rms)

	Ics	AC 50/60 Hz	220/240 V
			380/415 V
			440 V
			500 V
			525 V
			660/690 V

Durability (C-O cycles)	Mechanical	Electrical	440 V	In/2
				In
			690 V	In/2
				In

Characteristics as per UL 508

Breaking capacity (kA rms)	AC 50/60 Hz	240 V
		480 V
		600 V

Protection and Measurements

Short-circuit protection	Magnetic only
Overload/short-circuit protection	Thermal magnetic
	Electronic

With neutral protection (Off-0.5-1-OSN) [1]

With ground-fault protection

With zone selective interlocking (ZSI) [2]

Display/I, U, f, P, E, THD measurements/interrupted-current measurement

Options	Power meter display on door
	Operating assistance
	Counters
	Histories and alarms
	Metering Com
	Device status/control Com
	By VigiPacT add-on [3]

Earth-leakage protection	By VigiPacT add-on [3]
	By VigiPacT relay

Installation/Connections

Dimensions and weights

Dimensions (mm)	Fixed, front connections	2/3P
		4P
Weight (kg)	Fixed, front connections	2/3P
		4P

Connection terminals	Pitch	With/without spreaders
	Large Cu or Al cables	Cross-section

Source-Changeover System

Manual mechanical interlocking
Automatic source-changeover

[1] OSN: Over Sized Neutral protection for neutrals carrying high currents (e.g. 3rd harmonics).

[2] ZSI: Zone Selective Interlocking using pilot wires.

[3] VigiPacT add-on is not available for breaking capacity levels HB1/HB2.

[4] There is no 160 A frame, use 250 A frame with lower rating trip units for R, HB1, HB2.

[5] 2P circuit breaker in 3P case for B and F types, only with thermal-magnetic trip unit.

[6] Earth Leakage Circuit Breaker (MicroLogic Vigi 4.2 and 7.2 E).

Characteristics and Performance

ComPacT NSX Circuit Breakers from 100 to 250 A up to 690 V



Common Characteristics			
Control	Manual	With toggle	<input checked="" type="radio"/>
		With direct or extended rotary handle	<input checked="" type="radio"/>
Versions	Electrical	With remote control	<input checked="" type="radio"/>
	Fixed		<input checked="" type="radio"/>
	Withdrawable	Plug-in base	<input checked="" type="radio"/>
		Chassis	<input checked="" type="radio"/>

NSX100									NSX160 ^[4]									NSX250								
B	F	N	H	S	L	R	HB1	HB2	B	F	N	H	S	L	R	HB1	HB2	B	F	N	H	S	L	R	HB1	HB2
100						100			160						250											
2 ^[5] , 3, 4						3, 4			2 ^[5] , 3, 4						2 ^[5] , 3, 4											
40	85	90	100	120	150	200	-	-	40	85	90	100	120	150	200	-	-	40	85	90	100	120	150	200	-	-
25	36	50	70	100	150	200	-	-	25	36	50	70	100	150	200	-	-	25	36	50	70	100	150	200	-	-
20	35	50	65	90	130	200	-	-	20	35	50	65	90	130	200	-	-	20	35	50	65	90	130	200	-	-
15	25	36	50	65	70	80	85	100	15	30	36	50	65	70	80	85	100	15	30	36	50	65	70	80	85	100
-	22	35	35	40	50	65	80	100	-	22	35	35	40	50	65	80	100	-	22	35	35	40	50	65	80	100
-	8	10	10	15	20	45	75	100	-	8	10	10	15	20	45	75	100	-	8	10	10	15	20	45	75	100
40	85	90	100	120	150	200	-	-	40	85	90	100	120	150	200	-	-	40	85	90	100	120	150	200	-	-
25	36	50	70	100	150	200	-	-	25	36	50	70	100	150	200	-	-	25	36	50	70	100	150	200	-	-
20	35	50	65	90	130	200	-	-	20	35	50	65	90	130	200	-	-	20	35	50	65	90	130	200	-	-
7	12	36	50	65	70	80	85	100	15	30	36	50	50	50	80	85	100	15	30	36	50	65	70	80	85	100
-	11	35	35	40	50	65	80	100	-	22	35	35	35	35	65	80	100	-	22	35	35	40	50	65	80	100
-	4	10	10	10	10	45	75	100	-	8	10	10	10	10	45	75	100	-	8	10	10	10	10	45	75	100
50000						20000			40000						20000			20000						20000		
50000						20000			40000						20000			20000						20000		
30000						10000			20000						10000			10000						10000		
20000						10000			15000						10000			10000						10000		
10000						5000			7500						5000			5000						5000		
-	85	85	85	-	-	-	-	-	-	85	85	85	-	-	-	-	-	-	85	85	85	-	-	-	-	-
-	25	50	65	-	-	-	-	-	-	35	50	65	-	-	-	-	-	-	35	50	65	-	-	-	-	-
-	10	10	10	-	-	-	-	-	-	10	10	10	-	-	-	-	-	-	15	15	15	-	-	-	-	-
<input checked="" type="radio"/>									<input checked="" type="radio"/>									<input checked="" type="radio"/>								
<input checked="" type="radio"/>									<input checked="" type="radio"/>									<input checked="" type="radio"/>								
<input checked="" type="radio"/>									<input checked="" type="radio"/>									<input checked="" type="radio"/>								
<input checked="" type="radio"/>									<input checked="" type="radio"/>									<input checked="" type="radio"/>								
<input checked="" type="radio"/>									<input checked="" type="radio"/>									<input checked="" type="radio"/>								
<input checked="" type="radio"/>									<input checked="" type="radio"/>									<input checked="" type="radio"/>								
<input checked="" type="radio"/>									<input checked="" type="radio"/>									<input checked="" type="radio"/>								
<input checked="" type="radio"/>									<input checked="" type="radio"/>									<input checked="" type="radio"/>								
<input checked="" type="radio"/>									<input checked="" type="radio"/>									<input checked="" type="radio"/>								
<input checked="" type="radio"/>									<input checked="" type="radio"/>									<input checked="" type="radio"/>								
<input checked="" type="radio"/>									<input checked="" type="radio"/>									<input checked="" type="radio"/>								
<input checked="" type="radio"/>									<input checked="" type="radio"/>									<input checked="" type="radio"/>								
<input checked="" type="radio"/>									<input checked="" type="radio"/>									<input checked="" type="radio"/>								
<input checked="" type="radio"/>									<input checked="" type="radio"/>									<input checked="" type="radio"/>								
<input checked="" type="radio"/>									<input checked="" type="radio"/>									<input checked="" type="radio"/>								
<input checked="" type="radio"/>									<input checked="" type="radio"/>									<input checked="" type="radio"/>								
<input checked="" type="radio"/>									<input checked="" type="radio"/>									<input checked="" type="radio"/>								
<input checked="" type="radio"/>									<input checked="" type="radio"/>									<input checked="" type="radio"/>								
<input checked="" type="radio"/>									<input checked="" type="radio"/>									<input checked="" type="radio"/>								
<input checked="" type="radio"/>									<input checked="" type="radio"/>									<input checked="" type="radio"/>								
<input checked="" type="radio"/>									<input checked="" type="radio"/>									<input checked="" type="radio"/>								
<input checked="" type="radio"/>									<input checked="" type="radio"/>									<input checked="" type="radio"/>								
<input checked="" type="radio"/>									<input checked="" type="radio"/>									<input checked="" type="radio"/>								
<input checked="" type="radio"/>									<input checked="" type="radio"/>									<input checked="" type="radio"/>								
<input checked="" type="radio"/>									<input checked="" type="radio"/>									<input checked="" type="radio"/>								
<input checked="" type="radio"/>									<input checked="" type="radio"/>									<input checked="" type="radio"/>								
<input checked="" type="radio"/>									<input checked="" type="radio"/>									<input checked="" type="radio"/>								
<input checked="" type="radio"/>									<input checked="" type="radio"/>									<input checked="" type="radio"/>								
<input checked="" type="radio"/>									<input checked="" type="radio"/>									<input checked="" type="radio"/>								
<input checked="" type="radio"/>									<input checked="" type="radio"/>									<input checked="" type="radio"/>								
<input checked="" type="radio"/>									<input checked="" type="radio"/>									<input checked="" type="radio"/>								
<input checked="" type="radio"/>									<input checked="" type="radio"/>									<input checked="" type="radio"/>								
<input checked="" type="radio"/>									<input checked="" type="radio"/>									<input checked="" type="radio"/>								
<input checked="" type="radio"/>									<input checked="" type="radio"/>									<input checked="" type="radio"/>								
<input checked="" type="radio"/>									<input checked="" type="radio"/>									<input checked="" type="radio"/>								
<input checked="" type="radio"/>									<input checked="" type="radio"/>									<input checked="" type="radio"/>								
<input checked="" type="radio"/>									<input checked="" type="radio"/>									<input checked="" type="radio"/>								
<input checked="" type="radio"/>									<input checked="" type="radio"/>									<input checked="" type="radio"/>								
<input checked="" type="radio"/>									<input checked="" type="radio"/>									<input checked="" type="radio"/>								
<input checked="" type="radio"/>									<input checked="" type="radio"/>									<input checked="" type="radio"/>								
<input checked="" type="radio"/>									<input checked="" type="radio"/>									<input checked="" type="radio"/>								
<input checked="" type="radio"/>									<input checked="" type="radio"/>									<input checked="" type="radio"/>								
<input checked="" type="radio"/>									<input checked="" type="radio"/>									<input checked="" type="radio"/>								
<input checked="" type="radio"/>									<input checked="" type="radio"/>									<input checked="" type="radio"/>								
<input checked="" type="radio"/>									<input checked="" type="radio"/>									<input checked="" type="radio"/>								
<input checked="" type="radio"/>									<input checked="" type="radio"/>									<input checked="" type="radio"/>								
<input checked="" type="radio"/>									<input checked="" type="radio"/>									<input checked="" type="radio"/>								
<input checked="" type="radio"/>									<input checked="" type="radio"/>									<input checked="" type="radio"/>								
<input checked="" type="radio"/>									<input checked="" type="radio"/>									<input checked="" type="radio"/>								
<input checked="" type="radio"/>									<input checked="" type="radio"/>									<input checked="" type="radio"/>								
<input checked="" type="radio"/>									<input checked="" type="radio"/>									<input checked="" type="radio"/>								
<input checked="" type="radio"/>									<input checked="" type="radio"/>									<input checked="" type="radio"/>								
<input checked="" type="radio"/>									<input checked="" type="radio"/>									<input checked="" type="radio"/>								
<input checked="" type="radio"/>									<input checked="" type="radio"/>									<input checked="" type="radio"/>								
<input checked="" type="radio"/>									<input checked="" type="radio"/>									<input checked="" type="radio"/>								
<input checked="" type="radio"/>									<input checked="" type="radio"/>									<input checked="" type="radio"/>								
<input checked="" type="radio"/>																										

Characteristics and Performance

ComPacT NSX Circuit Breakers from 400 to 630 A up to 690 V

C83Y03BME630 eps



ComPacT NSX630 HB2

A

Common Characteristics

Rated voltages	Insulation voltage (V)	Ui	800
	Insulation voltage for ELCB [4]		500
	Impulse withstand voltage (kV)	Uimp	8
	Operational voltage (V)	Ue AC 50/60 Hz	690
	Operation voltage for ELCB [4]	Ue AC 50/60 Hz	440
Suitability for isolation		IEC/EN 60947-2	yes
Utilization category			A
Pollution degree		IEC 60664-1	3

Circuit Breakers

Breaking Capacity Levels

Electrical characteristics as per IEC/EN 60947-2

Rated current (A)	In	40 °C
-------------------	----	-------

Number of poles

Breaking capacity (kA rms)

Icu	AC 50/60 Hz	220/240 V
		380/415 V
		440 V
		500 V
		525 V
		660/690 V

Service breaking capacity (kA rms)

Ics	AC 50/60 Hz	220/240 V
		380/415 V
		440 V
		500 V
		525 V
		660/690 V

Durability (C-O cycles)

Mechanical	Electrical	440 V	In/2
			In
		690 V	In/2
			In

Characteristics as per UL 508

Breaking capacity (kA rms)	AC 50/60 Hz	240 V
		480 V
		600 V

Protection and Measurements

Short-circuit protection	Magnetic only
Overload/short-circuit protection	Thermal magnetic
	Electronic
	With neutral protection (Off-0.5-1-OSN) [1]
	With ground-fault protection
	With zone selective interlocking (ZSI) [2]

Display/I, U, f, P, E, THD measurements/interrupted-current measurement

Options	Power meter display on door
	Operating assistance
	Counters
	Histories and alarms
	Metering Com
	Device status/control Com

Earth-leakage protection	By VigiPacT add-on [3]
	By VigiPacT relay

Installation/Connections

Dimensions and weights

Dimensions (mm) W x H x D	Fixed, front connections	2/3P
		4P
Weight (kg)	Fixed, front connections	2/3P
		4P

Connections

Connection terminals	Pitch	With/without spreaders
Large Cu or Al cables	Cross-section	mm ²

Source-Changeover System

Manual mechanical interlocking
Automatic source-changeover

[1] OSN: Over Sized Neutral protection for neutrals carrying high currents (e.g. 3rd harmonics).

[2] ZSI: Zone Selective Interlocking using pilot wires.

[3] VigiPacT add-on is not available for breaking capacity levels HB1/HB2.

[4] Earth Leakage Circuit Breaker (MicroLogic Vigi 4.3 and 7.3 E)

Characteristics and Performance

ComPacT NSXm Switch-Disconnectors from 50 to 160 A NA

Installation standards require upstream protection. However ComPacT NSXm 50 to 160 NA switch-disconnectors are self-protected by their high-set magnetic release.

A



ComPacT NSXm switch-disconnectors

Common Characteristics

Rated voltages	Insulation voltage (V)	Ui	800
	Impulse withstand voltage (kV)	Uimp	8
	Operational voltage (V)	Ue	AC 50/60 Hz 690
Suitability for isolation		IEC/EN 60947-3	yes
Utilization category		AC 22 A/AC 23 A	
Pollution degree		IEC 60664-1	3

Switch-Disconnectors

Electrical characteristics as per IEC/EN 60947-3

Conventional thermal current (A) I_{th} 40 °C

Number of poles

Operational current (A) depending on the utilization category	I _e	AC 50/60 Hz	220/240 V 380/415 V 440/480 V 500/525 V 660/690 V
---	----------------	-------------	---

Short-circuit making capacity (kA peak)	I _{cm}	min. (switch-disconnector alone) max. (protection by upstream circuit breaker)
---	-----------------	---

Rated short-time withstand current (A rms)	I _{cw}	for	1 s 3 s 20 s
--	-----------------	-----	--------------------

Durability (C-O cycles)	Mechanical		
	Electrical	AC	440 V I _e /2 690 V I _e /2

Positive contact indication

Pollution degree

Additional indication and control auxiliaries

Indication contacts

Voltage releases	MX shunt trip release MN undervoltage release
------------------	--

Installation/connections

Dimensions and Weights

Dimensions (mm)	3P
W x H x D	4P
Weight (kg)	3P 4P

Connections

Pitch (mm)	Standard With spreaders
EverLink lug Cu or Al [1] cables	Cross-section (mm ²) Rigid Flexible
Crimp lugs Cu or Al	Cross-section (mm ²) Rigid Flexible

Source-changeover systems

Manual mechanical interlocking

[1] Al up to 100 A.

Characteristics and Performance

ComPacT NSXm Switch-Disconnectors from 50 to 160 A NA



Common Characteristics

Control	Manual	With toggle	<input checked="" type="radio"/>
		With direct or extended rotary handle	<input checked="" type="radio"/>
		With side rotary handle	<input checked="" type="radio"/>
Versions	Fixed		<input checked="" type="radio"/>

	NSXm50NA	NSXm100NA	NSXm160NA
	50	100	160
	3, 4	3, 4	3, 4
	AC22A/AC23A	AC22A/AC23A	AC22A/AC23A
	50	100	160/100
	50	100	160/100
	50	100	160/100
	50	100	160/100
	50	100	160/100
	1.28	2.13	2.13
	150	150	150
	900	1500	1500
	900	1500	1500
	200	335	335
	20000	20000	20000
	AC22A/AC23A	AC22A/AC23A	AC22A/AC23A
	20000/20000	20000/20000	20000/20000
	10000/10000	10000/10000	10000/10000
	10000/6000	10000/6000	10000/6000
	5000/3000	5000/3000	5000/3000
	<input checked="" type="radio"/>	<input checked="" type="radio"/>	<input checked="" type="radio"/>
	3	3	3
	<input checked="" type="radio"/>	<input checked="" type="radio"/>	<input checked="" type="radio"/>
	<input checked="" type="radio"/>	<input checked="" type="radio"/>	<input checked="" type="radio"/>
	<input checked="" type="radio"/>	<input checked="" type="radio"/>	<input checked="" type="radio"/>
	81 x 137 x 80		
	108 x 137 x 80		
	1.06		
	1.42		
	27		
	35		
	95		
	70		
	120		
	95		
	<input checked="" type="radio"/>		

Characteristics and Performance

ComPacT NSX Switch-Disconnectors from 100 to 630 A NA

Installation standards require upstream protection. However ComPacT NSX100 to 630 NA switch-disconnectors are self-protected by their high-set magnetic release.

A



ComPacT NSX100 to 250 NA



ComPacT NSX400 to 630 NA

> Discover our specific switch-disconnectors offer: ComPacT INS/INV



LVPED213024EN

[1] 2P in 3P case.

Common Characteristics

Rated voltages	Insulation voltage (V)	Ui	800
	Impulse withstand voltage (kV)	Uimp	8
	Operational voltage (V)	Ue	AC 50/60 Hz 690
Suitability for isolation		IEC/EN 60947-3	yes
Utilization category		AC 22 A/AC 23 A - DC 22 A/DC 23 A	
Pollution degree		IEC 60664-1	3

Switch-Disconnectors

Electrical characteristics as per IEC/EN 60947-3

Conventional thermal current (A)	Ith 40 °C		
Number of poles			
Operational current (A) depending on Ie the utilization category		AC 50/60 Hz	
			220/240 V
			380/415 V
			440/480 V
			500/525 V
			660/690 V
		DC	
			250 V (1 pole)
			500 V (2 poles in series)
			750 V (3 poles in series)
Short-circuit making capacity (kA peak)	Icm	Min. (switch-disconnector alone)	
		Max. (protection by upstream circuit breaker)	
Rated short-time withstand current (A rms)	Icw	for	1 s
			3 s
			20 s
Durability (C-O cycles)		Mechanical	
		Electrical	AC
			440 V
			In/2
			In
			690 V
			In/2
			In
		DC	250 V (1 pole) and
			500 V (2 poles in series)In

Positive contact indication

Pollution degree

Protection

Add-on earth-leakage protection By VigiPacT add-on
By VigiPacT relay

Additional indication and control auxiliaries

Indication contacts

Voltagess releases MX shunt release
MN undervoltage release

Current-transformer module

Insulation monitoring module

Remote communication by bus

Device-status indication

Device remote operation

Operation counter

Installation/connections

Dimensions (mm)	Fixed, front connections	2/3P
W x H x D		4P
Weight (kg)	Fixed, front connections	3P
		4P

Source-changeover systems

(see chapter on Source-changeover systems)

Manual mechanical interlocking

Automatic source-changeover

Characteristics and Performance

ComPacT NSX Switch-Disconnectors from 100 to 630 A NA



Common Characteristics

Control	Manual	With toggle	<input type="radio"/>
		With direct or extended rotary handle	<input type="radio"/>
Versions	Electrical	With remote control	<input type="radio"/>
	Fixed		<input type="radio"/>
	Withdrawable	Plug-in base	<input type="radio"/>
		Chassis	<input type="radio"/>

NSX100NA	NSX160NA	NSX250NA	NSX400NA	NSX630NA
100	160	250	400	630
2 [1], 3, 4	2 [1], 3, 4	2 [1], 3, 4	3, 4	3, 4
AC22A/AC23A	AC22A/AC23A	AC22A/AC23A	AC22A/AC23A	AC22A/AC23A
100	160	250	400	630
100	160	250	400	630
100	160	250	400	630
100	160	250	400	630
100	160	250	400	630
DC22A/DC23A	DC22A/DC23A	DC22A/DC23A	-	-
100	160	250	-	-
100	160	250	-	-
100	160	250	-	-
2.6	3.6	4.9	7.1	8.5
330	330	330	330	330
1800	2500	3500	5000	6000
1800	2500	3500	5000	6000
690	960	1350	1930	2320
50000	40000	20000	15000	15000
AC22A/AC23A	AC22A/AC23A	AC22A/AC23A	AC22A/AC23A	AC22A/AC23A
35000	30000	15000	10000	6000
20000	15000	7500	5000	3000
15000	10000	6000	5000	3000
8000	5000	3000	2500	1500
10000	10000	10000	-	-
5000	5000	5000	-	-
<input type="radio"/>	<input type="radio"/>	<input type="radio"/>	<input type="radio"/>	<input type="radio"/>
3	3	3	3	3
<input type="radio"/>			<input type="radio"/>	
<input type="radio"/>			<input type="radio"/>	
<input type="radio"/>			<input type="radio"/>	
<input type="radio"/>			<input type="radio"/>	
<input type="radio"/>			<input type="radio"/>	
<input type="radio"/>			<input type="radio"/>	
<input type="radio"/>			<input type="radio"/>	
105 x 161 x 86			140 x 255 x 110	
140 x 161 x 86			185 x 255 x 110	
1.5 to 1.8			5.2	
2.0 to 2.2			6.8	
<input type="radio"/>			<input type="radio"/>	
<input type="radio"/>			<input type="radio"/>	

General Characteristics of the ComPacT Range

DB43277.ai

A

A	NSXm 160H		B
C	C12H3TM160L		B
D	Ui 800V	Uimp 8kV	E
	Ue(V)	Icu(kA)	Ics(kA)
	220-240 ~	100	100
	380-415 ~	70	70
	440 ~	65	65
F			
G	50/60Hz	40°C	
	IEC/EN 60947-2	Cat A	

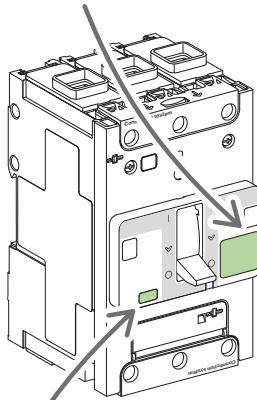

H Ir(A) 63/160
In=60A

Standardized characteristics indicated on the rating plate:

- A** Type of device: frame size and breaking capacity class
- B** Circuit breaker/switch-disconnector symbol
- C** Commercial reference
- D** Ui: rated insulation voltage
- E** Uimp: rated impulse withstand voltage
- F** Ue: operational voltage
- G** Reference standard
- H** Circuit breaker rating

Note: When the circuit breaker is equipped with an extended rotary handle, the door must be opened to access the rating plate.

DB410174.epg



Compliance with Standards

ComPacT NSX and NSXm circuit breakers and switch-disconnectors comply with the following:

- International standards
 - IEC 60947-1: general rules
 - IEC 60947-2: circuit breakers
 - IEC 60947-3: switch-disconnectors
 - IEC 60947-4-1: contactors and motor starters ^[1]
 - IEC 60947-5-1 and following: control circuit devices and switching elements; automatic control components
- European standards (EN 60947-1, EN 60947-2, EN 60947-3 and EN 60947-5-1)
 - China CCC
 - EAC (Customs Union)
- The specifications of the marine classification companies (Veritas, Lloyd's Register of Shipping, Det Norske Veritas, etc.), recommendations issued by the CNOMO organization for the protection of machine tools.

Pollution Degree

ComPacT NSX and NSXm circuit breakers and switch-disconnectors are certified for operation in pollution degree 3 environments as defined by IEC standards 60947-1 and 60664-1 (industrial environments).

Climatic Withstand

ComPacT NSX and NSXm circuit breakers have successfully passed the tests defined by the following standards for extreme atmospheric conditions.

Dry cold and dry heat

- IEC 60068-2-1: dry cold at -55 °C
- IEC 60068-2-2: dry heat at +85 °C

Damp heat (tropicalization)

- IEC 60068-2-30: damp heat (temperature + 55 °C and relative humidity of 95 %)
- IEC 60068-2-52: severity 2 - Cycling salt mist

Environment

ComPacT NSX and NSXm respects the European environment directive EC/2002/95 concerning the restriction of hazardous substances (RoHS) and is Green Premium.

Product environment profiles (PEP) have been prepared, describing the environmental impact of every product throughout its life cycle, from production to the end of its service life.

All ComPacT production sites have set up an environmental management system certified ISO 14001.

Each factory monitors the impact of its production processes. Every effort is made to prevent pollution and to reduce consumption of natural resources.

Ambient Temperature

- ComPacT NSX and NSXm circuit breakers may be used between -25 °C And +70 °C. For temperatures higher than 40 °C, (For ComPacT NSX: +65 °C for circuit breakers used to protect motor feeders) devices must be derated (pages E-8 to E-9 and E-14 to E-17).
- Circuit breakers should be put into service under normal ambient, operating-temperature conditions. Exceptionally, the circuit breaker may be put into service when the ambient temperature is between -35 °C and -25 °C.
- The permissible storage temperature range for ComPacT NSX and NSXm circuit breakers in the original packing is -50 °C ^[2] ^[3] and +85 °C.

[1] For ComPacT NSX

[2] For ComPacT NSXm: - 40 °C for ComPacT NSXm MicroLogic Vigi 4.1.

[3] For ComPacT NSX: -40 °C for MicroLogic control units with an LCD screen and MicroLogic Vigi 4.

Select Circuit Breakers and Switch-Disconnectors

General Characteristics of the ComPacT Range

Electromagnetic Compatibility

ComPacT NSX and NSXm devices are protected against:

- Overvoltages caused by circuit switching (e.g. lighting circuits)
- Overvoltages caused by atmospheric disturbances
- Devices emitting radio waves such as mobile telephones, radios, walkie-talkies, radar, etc.
- Electrostatic discharges produced by users.

Immunity levels for ComPacT NSXm comply with the standards below.

- IEC/EN 60947-2: Low-voltage switchgear and controlgear, part 2: Circuit breakers:
 - Annex F: Immunity tests for circuit breakers with electronic protection
 - Annex B: Immunity tests for residual current protection
- IEC/EN 61000-4-2: Electrostatic-discharge immunity tests
- IEC/EN 61000-4-3: Radiated, radio-frequency, electromagnetic-field immunity tests
- IEC/EN 61000-4-4: Electrical fast transient/burst immunity tests
- IEC/EN 61000-4-5: Surge immunity tests
- IEC/EN 61000-4-6: Immunity tests for conducted disturbances induced by radio-frequency fields
- IEC/EN 61000-4-8: Power frequency magnetic field immunity test
- IEC/EN 61000-4-11: Voltage dips, short interruptions and voltage variations immunity tests
- CISPR 11: Industrial, scientific and medical equipment - Radio-frequency disturbance characteristics - Limits and methods of measurement.

Suitable for Isolation with Positive Contact Indication

All ComPacT NSX and NSXm devices are suitable for isolation as defined in IEC standard 60947-2:

- The isolation position corresponds to the O (OFF) position.
- The operating handle cannot indicate the OFF position unless the contacts are effectively open.
- Padlocks may not be installed unless the contacts are open.

Installation of a rotary handle or a motor mechanism does not alter the reliability of the position-indication system.

The isolation function is certified by testing:

- The mechanical reliability of the position-indication system
- The absence of leakage currents
- Overvoltage withstand capacity between upstream and downstream connections. The tripped position does not insure isolation with positive contact indication. Only the OFF position confirms isolation.

Installation in Class II Switchboards

All ComPacT NSX and NSXm devices are class II front face devices. They may be installed through the door of class II switchboards (as per IEC standards 61140 and 60664-1) without downgrading switchboard insulation. Installation requires no special operations, even when the circuit breaker is equipped with a rotary handle or a motor mechanism.

Degree of Protection

The following indications are in accordance with standards IEC 60529 (IP degree of protection) and IEC 62262 (IK protection against external mechanical impacts).

Bare Circuit Breaker with Terminal Shields

- With toggle: IP40, IK07
- With direct rotary handle: IP40 IK07

Circuit Breaker Installed in a Switchboard

ComPacT NSXm

- With toggle: IP40, IK07
- With direct rotary handle: IP40, IK07
- With extended rotary handle: IP54 or IP65 IK08
- With side rotary handle: IP54 or IP65 IK08

ComPacT NSX

- With toggle: IP40, IK07
- With direct rotary handle:
 - Standard/VDE: IP40, IK07
 - MCC: IP43 IK07
 - CNOMO: IP54 IK08
- With extended rotary handle: IP55 IK08
- With motor mechanism: IP40 IK07

For more detail about IP, see [page E-7](#).

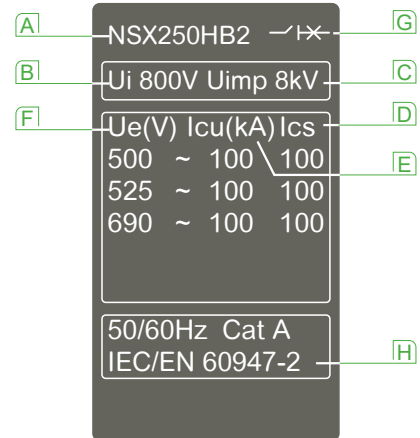

Standardized characteristics indicated on the rating plate:

- A** Type of device: frame size and breaking capacity class
- B** Ui: rated insulation voltage
- C** Uimp: rated impulse withstand voltage
- D** Ics: service breaking capacity
- E** Icu: ultimate breaking capacity for various values of the rated operational voltage Ue
- F** Ue: operational voltage
- G** Circuit breaker/switch-disconnector symbol
- H** Reference standard

Note: When the circuit breaker is equipped with an extended rotary handle, the door must be opened to access the rating plate.



ComPacT NSX Special Applications

High Performances at 690 V

ComPacT NSX R/HB1/HB2 circuit breaker is designed specifically for the needs of systems operating at 690 V.

A



ComPacT NSX100 to 250



ComPacT NSX400 to 630

Markets

- Marine
- Oil and gas
- Data centers
- Other markets pursuing energy efficiency (water, industrial, etc.).

Ability to Service High Power Densities

- Upgrade voltage from ~415-440 to 690 V system allows:
 - Smaller cables can be used
 - Reduced cost and space
 - Reduced energy loss in transmission
 - Motors are more efficient at 690 V
- Consider 690 V as an alternative MV system:
 - Lower cost, smaller footprint, and improved maintenance.

Safety

IACS (International Association of Classification Societies) change, requires Ics rating for emergency systems:

- Key influence on Marine systems of high Ics ratings
- Continuity of service after 3 faults.

Technology

- Best in class technology and performance:
 - High breaking capacity
 - NSX family consistency of energy metering, alarming and diagnosis
- Provides alternative to fuse protection at 690 V applications.

Enhancing Solutions

- Using smaller frames for 690 V high performance circuits:
 - Space and cost benefit
 - NSX family consistency with same NSX accessories
- 200 kA breaking capacity on R rating will be mainly used for:
 - High power factor applications: around 2.8 instead of 2.2
 - Selectivity with MasterPact UR.

Type I & II Coordination for Motor Applications

- Type I & II coordination with TeSys contactors is available up to 690 V.
- Coordination tables are prepared with external overload relays and protection integrated into the MicroLogic trip units.
- See complementary bulletin for ratings.

Compliance with Standards

ComPacT NSX circuit breakers and auxiliaries comply with the following:

- International recommendations
 - IEC 60947-1: general rules
 - IEC 60947-2: circuit breakers
 - IEC 60947-3: switch-disconnectors
 - IEC 60947-4: contactors and motor starters
 - IEC 60947-5.1 and following: control circuit devices and switching elements; automatic control components
- European (EN 60947-1, EN 60947-2, EN 60947-3 and EN 60947-5.1) and corresponding national standards
 - China CCC
 - EAC (Customs Union)
- The specifications of the marine classification companies (Veritas, Lloyd's Register of Shipping, Det Norske Veritas, etc.), recommendations issued by the CNOMO organization for the protection of machine tools.

Select Circuit Breakers and Switch-Disconnectors

ComPacT NSX Special Applications

High Performances at 690 V

Circuit Breakers (Fed from Bottom)		NSX100-250 [1]			NSX400			NSX630						
Breaking Capacity Levels		R	HB1	HB2	R	HB1	HB2	R	HB1	HB2	R	HB1	HB2	
Electrical characteristics														
Breaking capacity (kA rms)														
Icu	AC 50/60 Hz	220/240 V	150	-	-	150	-	-	Ir < 500 A			Ir > 501 A		
		380/415 V	150	-	-	150	-	-	150	-	-	150	-	-
		440 V	130	-	-	130	-	-	130	-	-	130	-	-
		500 V	70	70	70	40	40	50	40	40	50	40	40	50
		525 V	50	50	50	35	35	40	35	35	40	-	-	-
		690 V	20	20	20	30	30	35	30	30	35	-	-	-
Service breaking capacity (kA rms)														
Ics	AC 50/60 Hz	220/240 V	150	-	-	150	-	-	Ir < 500 A			Ir > 501 A		
		380/415 V	150	-	-	150	-	-	150	-	-	150	-	-
		440 V	130	-	-	130	-	-	130	-	-	130	-	-
		500 V	70	70	70	40	40	50	40	40	50	40	40	50
		525 V	50	50	50	10	10	12	10	10	12	-	-	-
		690 V	10	10	10	10	10	10	10	10	10	-	-	-

[1] There is no 160 A frame, use the 250 A frame with lower rating trip units.

Offer Structure

The ComPacT NSX HB offer has some differences compared to the standard NSX offer.

- 100 A frame and 250 A frame, there is no 160 A frame. The 125 - 160 A trip units are used in a 250 A frame.
- All R, HB1 and HB2 circuit breakers can be fed from top and bottom of the circuit breaker.
- [2] Check the remark: check both tables from performances of each supply.
- ComPacT NSX400-630 R/HB1/HB2, U > 440 V, Icu 20 kA, Line/Load connection possible with insulation screen.
- All trip units are assembled in factory.

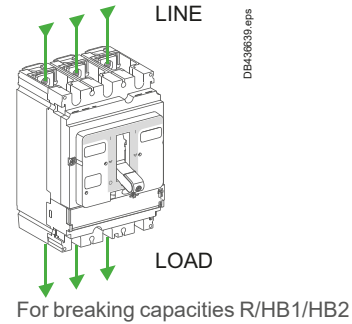

Type of protection	Distribution protection		Motor protection	
	TMD	MicroLogic	MA	MicroLogic
ComPacT NSX100	40-100	2.2: 40-100 5.2 E: 40-100 6.2 E: 40-100	12.5-100	2.2 M: 25, 50, 100 6.2 E-M: 25, 50, 100
ComPacT NSX250	125-250	2.2: 100, 160, 250 5.2 E: 100, 160, 250 6.2 E: 100, 160, 250	150, 220	2.2 M: 150, 220 6.2 E-M: 150, 220
ComPacT NSX400	-	2.3: 250, 400 5.3 E: 250, 400 6.3 E: 250, 400	-	1.3 M: 320 2.3 M: 320 6.3 M: 320
ComPacT NSX630	-	2.3: 630 5.3 E: 630 6.3 E: 630	-	1.3 M: 500 2.3 M: 500 6.3 M: 500



Select Protection

Trip Unit Overview

Protection of Distribution Systems

ComPacT NSXm TM Thermal-Magnetic Trip Units	B-4
ComPacT NSX TM Thermal-Magnetic and MA Magnetic Trip Units	B-6
Function Overview	B-8
ComPacT NSXm + NSX Circuit Breakers Trip Units	B-9
ComPacT NSX MicroLogic 2 and 1.3 Trip Units.....	B-10
ComPacT NSX MicroLogic 5/6 E Trip Units.....	B-12
ComPacT NSXm MicroLogic Vigi 4.1 Trip Unit.....	B-14
ComPacT NSX MicroLogic Vigi 4 Trip Unit.....	B-16
ComPacT NSX MicroLogic Vigi 7 E Trip Unit.....	B-18
ComPacT NSX MicroLogic Vigi 7 E Trip Unit.....	B-20
ComPacT NSX VigiPacT Add-on Protection Against Insulation Faults.....	B-22

ComPacT NSX Motor Protection

General Information on Motor Feeders	B-26
Motor-Feeder Characteristics and Solutions	B-28
Motor-Feeder Solutions.....	B-29
MA Instantaneous Trip Units	B-30
MicroLogic 1.3 M Instantaneous Trip Units	B-31
MicroLogic 2.2/2.3 M Electronic Trip Units.....	B-32
MicroLogic 6 E-M Electronic Trip Units	B-34

ComPacT NSX Measurement

MicroLogic 5/6/7 E Electronic Trip Units.....	B-38
---	------

ComPacT NSX Diagnostics & Maintenance

MicroLogic 5/6/7 E Electronic Trip Units.....	B-42
---	------

ComPacT NSX Special Applications

Protection of Public Distribution Systems with MicroLogic 2-AB.....	B-45
ComPacT NSX MicroLogic Vigi 4-AB Trip Unit with Embedded Earth Leakage Protection	B-48
Generator Protection with MicroLogic 2.2 G.....	B-50
Protection of Industrial Control Panels	B-52
16 Hz 2/3 Network Protection - MicroLogic 5 A-Z Trip Unit	B-54
Protection of 400 Hz Systems	B-55
ComPacT NSX400K at 1000 V AC	B-58

ComPacT NSX Special Applications	B-59
--	------

Other Chapters





Select Circuit Breakers and Switch-Disconnectors	A-1
Customize Circuit Breakers with Accessories.....	C-1
Smart Panel Integration	D-1
Switchboard Integration.....	E-1
Catalog Numbers	F-1
Glossary	G-1
Additional Characteristics.....	H-1



Select Protection Trip Unit Overview

ComPacT NSXm has a built-in trip unit.

B

	ComPacT NSXm up to 160 A		ComPacT NSX up to 250 A	
	 <p>C12H3TM160L.eps</p> <p>TM-D Distribution</p>	 <p>C12H4V160L.eps</p> <p>MicroLogic Vigi 4.1 Distribution and Earth Leakage Protection</p>	 <p>C25W3MA220.eps</p> <p>MA Distribution and Motors</p>	 <p>C25W3TM250.eps</p> <p>TM-D Distribution TM-G Generators</p>

	LI	LS ₀ IR	I	LI
Protections				
Standard protections	LI	LS ₀ IR	I	LI
Settings and indications	Pick-up set in amps using dials Non-adjustable time delay			
Front indication	<input checked="" type="checkbox"/>	<input checked="" type="checkbox"/>	<input checked="" type="checkbox"/>	<input checked="" type="checkbox"/>
Test connector	<input checked="" type="checkbox"/>	<input checked="" type="checkbox"/>	<input checked="" type="checkbox"/>	<input checked="" type="checkbox"/>
Self test	<input checked="" type="checkbox"/>	<input checked="" type="checkbox"/>	<input checked="" type="checkbox"/>	<input checked="" type="checkbox"/>
Measurements				
Embedded measurements ^[1]				
Diagnostic & Maintenance				
Status indication	<input checked="" type="checkbox"/>	<input checked="" type="checkbox"/>	<input checked="" type="checkbox"/>	<input checked="" type="checkbox"/>
Operating assistance				
Control				
Voltage release	<input checked="" type="checkbox"/>	<input checked="" type="checkbox"/>	<input checked="" type="checkbox"/>	<input checked="" type="checkbox"/>
Motor mechanism			<input checked="" type="checkbox"/>	<input checked="" type="checkbox"/>
Communication				
Modbus SL			<input checked="" type="checkbox"/>	<input checked="" type="checkbox"/>
Ethernet			<input checked="" type="checkbox"/>	<input checked="" type="checkbox"/>
Local display			<input checked="" type="checkbox"/>	<input checked="" type="checkbox"/>
Input/Output control				
SDx		<input checked="" type="checkbox"/>		
I/O module			<input checked="" type="checkbox"/>	<input checked="" type="checkbox"/>
Earth Leakage				
Embedded protection		<input checked="" type="checkbox"/>		
VigiPacT add-on module			<input checked="" type="checkbox"/>	<input checked="" type="checkbox"/>
VigiPacT relay	<input checked="" type="checkbox"/>		<input checked="" type="checkbox"/>	<input checked="" type="checkbox"/>

[1] For more details, refer to page B-43.

ComPacT NSX offers a range of trip units in interchangeable cases, whether they are magnetic, thermal-magnetic or electronic. Versions 5 and 6 of the electronic trip unit offer communication and metering. Using MicroLogic sensors and intelligence, ComPacT NSX supplies all the information required to manage the electrical installation and optimize energy use.

ComPacT NSX up to 630 A



MicroLogic 2 and 1.3 100-250 A 400-630 A		MicroLogic 4 100-250 A 400-630 A		MicroLogic 5 and 6 100-250 A 400-630 A		MicroLogic 7 100-250 A 400-630 A	
Distribution		Distribution and earth-leakage protection		Distribution and generators		Distribution and earth-leakage protection	
2.2	2.3	2.2	2.3	5.2 E/6.2 E	5.3 E/6.3 E	7.2 E	7.3 E
Service connection utilities		Service connection utilities		Motors		7.2 EAL	7.3 EAL
2.2 AB	2.3 AB	4.2 AB	4.3 AB	6.2 E-M	6.3 E-M		
Motors		4.2 AL	4.3 AL				
2.2 M	1.3 M/2.3 M						
Generators							
2.2 G	2.3 G						
2.2 G	2.3 G						
LS ₀ I		LS ₀ I		LSI, LSIG		LSIG	
Pick-up set in amps using dials							
Non-adjustable time delay							
	<input checked="" type="radio"/>		<input checked="" type="radio"/>		<input checked="" type="radio"/>		<input checked="" type="radio"/>
	<input checked="" type="radio"/>		<input checked="" type="radio"/>		<input checked="" type="radio"/>		<input checked="" type="radio"/>
	<input checked="" type="radio"/>		<input checked="" type="radio"/>		<input checked="" type="radio"/>		<input checked="" type="radio"/>
					<input checked="" type="radio"/>		<input checked="" type="radio"/>
	<input checked="" type="radio"/>		<input checked="" type="radio"/>		<input checked="" type="radio"/>		<input checked="" type="radio"/>
	<input checked="" type="radio"/>		<input checked="" type="radio"/>		<input checked="" type="radio"/>		<input checked="" type="radio"/>
	<input checked="" type="radio"/>		<input checked="" type="radio"/>		<input checked="" type="radio"/>		<input checked="" type="radio"/>
	<input checked="" type="radio"/>		<input checked="" type="radio"/>		<input checked="" type="radio"/>		<input checked="" type="radio"/>
	<input checked="" type="radio"/>		<input checked="" type="radio"/>		<input checked="" type="radio"/>		<input checked="" type="radio"/>
	<input checked="" type="radio"/>		<input checked="" type="radio"/>		<input checked="" type="radio"/>		<input checked="" type="radio"/>
	<input checked="" type="radio"/>		<input checked="" type="radio"/>		<input checked="" type="radio"/>		<input checked="" type="radio"/>
	<input checked="" type="radio"/>		<input checked="" type="radio"/>		<input checked="" type="radio"/>		<input checked="" type="radio"/>
	<input checked="" type="radio"/>		<input checked="" type="radio"/>		<input checked="" type="radio"/>		<input checked="" type="radio"/>
	<input checked="" type="radio"/>		<input checked="" type="radio"/>		<input checked="" type="radio"/>		<input checked="" type="radio"/>



Protection of Distribution Systems

ComPacT NSXm TM Thermal-Magnetic Trip Units

ComPacT NSXm has a built-in thermal magnetic trip unit.



ComPacT NSXm 160

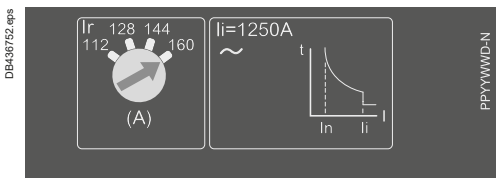

TM-D Thermal-Magnetic Trip Units

Circuit breakers equipped with thermal-magnetic trip units are used mainly in industrial and commercial electrical distribution applications for protection of cables on distribution systems supplied by transformers.

Protection

L Thermal Protection (Ir)

Thermal overload protection based on a bimetal strip providing an inverse time curve I^2t , corresponding to a temperature rise limit. Above this limit, the deformation of the strip trips the circuit breaker operating mechanism.

This protection operates according to:

- Ir that can be adjusted in amps from 0.7 to 1 times the rating of the circuit breaker (16 A to 160 A), corresponding to settings from 11 to 160 A for the range of products
- A non-adjustable time delay for cable protection.

I Magnetic Protection (Ii)

Short-circuit protection with a fixed pick-up Ii that initiates instantaneous tripping if exceeded with a non-adjustable time delay for selectivity and cascading.

Protection Versions

- 3-pole:
 - 3P 3D: 3-pole frame (3P) with detection on all 3 poles (3D)
- 4-pole:
 - 4P 3D: 4-pole frame (4P) with detection on 3 poles (3D)
 - 4P 4D: 4-pole frame (4P) with detection on all 4 poles (same threshold for phases and neutral).

Note: All the circuit breakers have a transparent lead-sealable cover that avoids access to the adjustment dials.

B

Protection of Distribution Systems

ComPacT NSXm TM Thermal-Magnetic Trip Units

Thermal-Magnetic Trip Units TM16D to 160D

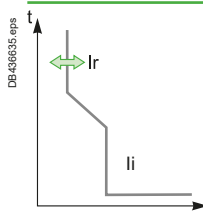

Ratings (A)	In at 40 °C ^[1]	16	25	32	40	50	63	80	100	125	160
Circuit breaker	ComPacT NSXm	<input checked="" type="radio"/>	<input checked="" type="radio"/>	<input checked="" type="radio"/>	<input checked="" type="radio"/>	<input checked="" type="radio"/>	<input checked="" type="radio"/>	<input checked="" type="radio"/>	<input checked="" type="radio"/>	<input checked="" type="radio"/>	<input checked="" type="radio"/>
L Thermal protection											
Pick-up (A) tripping between 1.05 and 1.20 Ir	$I_r = I_n \times \dots$	Adjustable in amps from 0.7 to 1 x I _n									
Time delay (s)	t _r	Non-adjustable									
I Magnetic protection											
Pick-up (A)	I _i	Fixed									
accuracy ±20 %	ComPacT NSXm	500	600	600	600	600	800	1000	1250	1250	1250
Time delay	t _m	Fixed									
Neutral protection											
Unprotected neutral	4P 3D	No detection									
Fully protected neutral	4P 4D	1 x I _r									

[1] If the circuit breakers are used in high-temperature environments, the setting must take into account the thermal limitations of the circuit breaker. See the temperature derating table.



Protection of Distribution Systems

ComPacT NSX TM Thermal-Magnetic and MA Magnetic Trip Units

TM thermal-magnetic and MA magnetic trip units can be used on ComPacT NSX100/160/250 circuit breakers with performance levels B/F/H/N/S/L. TM trip units are available in 2 versions:

- TM-D, for the protection of distribution cables
- TM-G, with a low threshold, for the protection of generators or long cable lengths



ComPacT NSX250 F

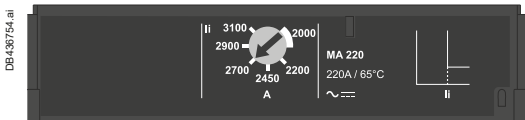

TM-D and TM-G Thermal-Magnetic Trip Units

Circuit breakers equipped with thermal-magnetic trip units are used mainly in industrial and commercial electrical distribution applications:

- TM-D, for protection of cables on distribution systems supplied by transformers
- TM-G, with a low pick-up for generators (lower short-circuit currents than with transformers) and distribution systems with long cable lengths (fault currents limited by the resistance of the cable).

Protection

Thermal Protection (Ir)

Thermal overload protection based on a bimetal strip providing an inverse time curve I^2t , corresponding to a temperature rise limit. Above this limit, the deformation of the strip trips the circuit breaker operating mechanism.

This protection operates according to:

- Ir that can be adjusted in amps from 0.7 to 1 times the rating of the trip unit (16 A to 250 A), corresponding to settings from 11 to 250 A for the range of trip units
- A non-adjustable time delay for cable protection.

Magnetic Protection (Ii)

Short-circuit protection with a fixed or adjustable pick-up Ii that initiates instantaneous tripping if exceeded.

- TM-D: fixed pick-up, Ii, for 16 to 160 A ratings and adjustable from 5 to 10 x In for 200 and 250 A ratings.
- TM-G: fixed pick-up for 16 to 250 A ratings.

Protection against insulation faults

Two solutions are possible by adding:

- A VigiPacT add-on acting directly on the trip unit of the circuit breaker
- A VigiPacT relay connected to an MN or MX voltage release.

Protection Versions

- 3-pole: 3P 3D: 3-pole frame (3P) with detection on all 3 poles (3D)
- 4-pole:
 - 4P 3D: 4-pole frame (4P) with detection on 3 poles (3D)
 - 4P 4D: 4-pole frame (4P) with detection on all 4 poles (same threshold for phases and neutral).

MA Magnetic Trip Units

In distribution applications, circuit breakers equipped with MA magnetic-only trip units are used for:

- Short-circuit protection of secondary windings of LV/LV transformers with overload protection on the primary side
- As an alternative to a switch-disconnector at the head of a switchboard in order to provide short-circuit protection.

Their main use is however for motor protection applications, in conjunction with a thermal relay and a contactor or motor starter.

Protection

Magnetic Protection (Ii)

Short-circuit protection with an adjustable pick-up Ii that initiates instantaneous tripping if exceeded.

- $Ii = In \times \dots$ set in amps on an adjustment dial covering the range 6 to 14 x In for 2.5 to 100 A ratings or 9 to 14 In for 150 to 220 A ratings.

Protection Versions

- 3-pole (3P 3D): 3-pole frame (3P) with detection on all 3 poles (3D)
- 4-pole (4P 3D): 4-pole frame (4P) with detection on 3 poles (3D)

Note: All the trip units have a transparent lead-sealable cover that avoids access to the adjustment dials.

Protection of Distribution Systems

ComPacT NSX TM Thermal-Magnetic and MA Magnetic Trip Units

B

Thermal-Magnetic Trip Units TM16D to 250D

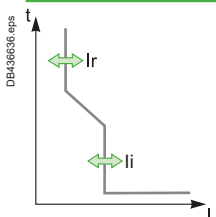

Ratings (A)	In at 40 °C [1]	16	25	32	40	50	63	80	100	125	160	200	250
Circuit breaker	ComPacT NSX100	●	●	●	●	●	●	●	●	-	-	-	-
	ComPacT NSX160	-	-	●	●	●	●	●	●	●	●	-	-
	ComPacT NSX250	-	-	-	-	-	-	●	●	●	●	●	●

L Thermal protection		
Pick-up (A) tripping between 1.05 and 1.20 Ir	Ir = In x ...	Adjustable in amps from 0.7 to 1 x In
Time delay (s)	tr	Non-adjustable
	tr at 1.5 x In	120 to 400
	tr at 6 x Ir	15

I Magnetic protection		
Pick-up (A) accuracy ±20 %	li	Fixed
	ComPacT NSX100	190 300 400 500 500 500 640 800
	ComPacT NSX160/250	190 300 400 500 500 500 640 800 1250 1250 5 to 10xIn
Time delay	tm	Fixed

Neutral protection		
Unprotected neutral	4P 3D	No detection
Fully protected neutral	4P 4D	1 x Ir

Thermal-Magnetic Trip Units TM16G to 250G

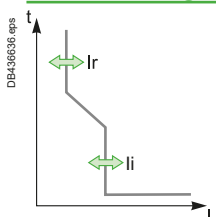

Ratings (A)	In at 40 °C [1]	16	25	40	63	80	100	125	160	200	250
Circuit breaker	ComPacT NSX100	●	●	●	●	●	●	-	-	-	-
	ComPacT NSX160	-	●	●	●	●	●	●	●	-	-
	ComPacT NSX250	-	-	-	-	-	-	-	●	●	●

L Thermal protection		
Pick-up (A) tripping between 1.05 and 1.20 Ir	Ir = In x ...	Adjustable in amps from 0.7 to 1 x In
Time delay (s)	tr	Non-adjustable
	tr at 1.5 x In	120 to 400
	tr at 6 x Ir	-

I Magnetic protection		
Pick-up (A) accuracy ±20 %	li	Fixed
	ComPacT NSX100	63 80 80 125 200 320 - - - -
	ComPacT NSX160	- 80 80 125 200 320 440 440 - -
	ComPacT NSX250	- - - - - - - 440 440 520
Time delay	tm	Fixed

Neutral protection		
Unprotected neutral	4P 3D	No
Fully protected neutral	4P 4D	1 x Ir

[1] For temperatures greater than 40 °C, the thermal protection characteristics are modified. See the temperature derating table.

Magnetic Trip Units MA 2.5 to 220

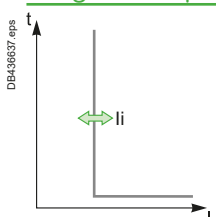

Ratings (A)	In at 65 °C [1]	2.5	6.3	12.5	25	50	100 [1]	150	220
Circuit breaker	ComPacT NSX100	●	●	●	●	●	●	-	-
	ComPacT NSX160	-	-	-	●	●	●	●	-
	ComPacT NSX250	-	-	-	-	-	●	●	●

I Instantaneous magnetic protection		
Pick-up (A) accuracy ±20 %	li = In x ...	Adjustable from 6 to 14 x In (settings 6, 7, 8, 9, 10, 11, 12, 13, 14)
		Adjustable from 9 to 14 x In (settings 9, 10, 11, 12, 13, 14)
Time delay (ms)	tm	Fixed

[1] MA100 3P adjustable from 6 to 14 x In.
MA100 4P adjustable from 9 to 14 x In.

Note: All the trip units have a transparent lead-sealable cover that avoids access to the adjustment dials.

Protection of Distribution Systems

Function Overview

Measurement

Energy management is the challenge of present and future generations. To meet this requirement, MicroLogic E incorporates all the measuring functions of a power meter.

Diagnostics and Maintenance

Optimal continuity of services as well as extended life of equipment is one of customer main concerns. For that purpose MicroLogic E trip units contributes to corrective, preventive and predictive maintenance.

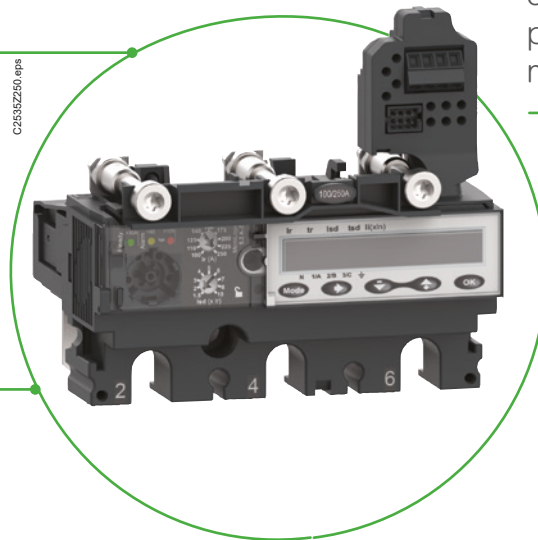

Protection

MicroLogic 5 (LSI), 6 (LSIG) and 7 (LSIR) offer a large long time delay setting range (0.4 to 1 xIn) and protection accuracy for a wide temperature range (-25 to +70 C).

Communication

- Protection Control Unit, provides local information for network operation and maintenance, as well as remote information for higher functions of control, monitoring, energy efficiency and assets management.
- To comply with those requirements MicroLogic trip unit and Enerlin'X communication system provides access to status, electrical values and devices control using Ethernet and Modbus SL communication protocols.

B

Select Protection

Protection of Distribution Systems

ComPacT NSX MicroLogic 2 and 1.3 Trip Units

MicroLogic 2 trip units can be used on ComPacT NSX100 to 630 circuit breakers with performance levels B/F/H/N/S/L/R/HB1/HB2.

They provide:

- Standard protection of distribution cables
- Indication of:
 - Overloads (via LEDs)
 - Overload tripping (via the SDx relay module).

DB436756.ai

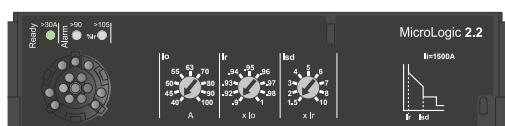

PB103377.eps



SDx remote indication relay module with its terminal block

DB436758.ai

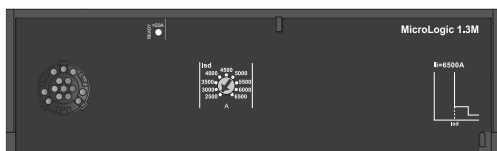

Note: All the trip units have a transparent lead-sealable cover that avoids access to the adjustment dials.

B-10

Life Is On

Schneider
Electric

MicroLogic 2

Circuit breakers equipped with MicroLogic 2 trip units can be used to protect distribution systems supplied by transformers. For generators and long cables, MicroLogic 2 G trip units offer better suited low pick-up solutions (see page B-50).

Protection

Settings are made using the adjustment dials with fine adjustment possibilities.

L Overloads: Long Time Protection (Ir)

Inverse time protection against overloads with an adjustable current pick-up I_r set using a dial and a non-adjustable time delay t_r .

S Short-Circuits: Short-Time Protection with Fixed Time Delay (Isd)

Protection with an adjustable pick-up I_{sd} . Tripping takes place after a very short delay used to allow selectivity with the downstream device.

I Short-Circuits: Non-Adjustable Instantaneous Protection

Instantaneous short-circuit protection with a fixed pick-up.

Neutral Protection

- On 3-pole circuit breakers, neutral protection is not possible.
- On four-pole circuit breakers, neutral protection may be set using a three-position switch:
 - 4P 3D: neutral unprotected
 - 4P 3D + N/2: neutral protection at half the value of the phase pick-up, i.e. $0.5 \times I_r$
 - 4P 4D: neutral fully protected at I_r .

DB436756.ai

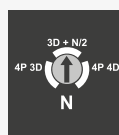

Indications

Front Indications

- Green "Ready" LED: flashes slowly when the circuit breaker is ready to trip in the event of a fault.
- Orange overload pre-alarm LED: steady on when $I > 90 \% I_r$.
- Red overload LED: steady on when $I > 105 \% I_r$.



Remote Indications

An overload trip signal can be remotely by installing an SDx relay module inside the circuit breaker.

This module receives the signal from the MicroLogic electronic trip unit via an optical link and makes it available on the terminal block. The signal is cleared when the circuit breaker is reclosed. For description, see page C-28.

MicroLogic 1.3 M for Magnetic Protection Only

MicroLogic 1.3 M trip units provide magnetic protection only, using electronic technology. They are dedicated to 400/630 A 3-poles (3P 3D) circuit breakers or 4-pole circuit breakers with detection on 3 poles (4P, 3D) and are used in certain applications to replace switch-disconnectors at the head of switchboards. They are especially used in 3-poles versions for motor protection, see page B-30.

Protection of Distribution Systems

ComPacT NSX MicroLogic 2 and 1.3 Trip Units

B

MicroLogic 2

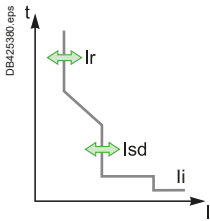

Ratings (A)	In at 40 °C [1]	40	100	160	250	400	630
Circuit breaker	ComPacT NSX100	●	●	-	-	-	-
	ComPacT NSX160	●	●	●	-	-	-
	ComPacT NSX250	●	●	●	●	-	-
	ComPacT NSX400	-	-	-	●	●	-
	ComPacT NSX630	-	-	-	●	●	●

L Long-time protection

Pick-up (A) tripping between 1.05 and 1.20 Ir	Io	Value depending on trip unit rating (In) and setting on dial								
In = 40 A	Io =	18	18	20	23	25	28	32	36	40
In = 100 A	Io =	40	45	50	55	63	70	80	90	100
In = 160 A	Io =	63	70	80	90	100	110	125	150	160
In = 250 A (NSX250)	Io =	100	110	125	140	160	175	200	225	250
In = 250 A (NSX400)	Io =	70	100	125	140	160	175	200	225	250
In = 400 A	Io =	160	180	200	230	250	280	320	360	400
In = 630 A	Io =	250	280	320	350	400	450	500	570	630
Ir = Io x ...		9 fine adjustment settings from 0.9 to 1 (0.9 - 0.92 - 0.93 - 0.94 - 0.95 - 0.96 - 0.97 - 0.98 - 1) for each value of Io								

Time delay (s) accuracy 0 to -20%	tr	Non-adjustable								
		1.5 x Ir	400							
		6 x Ir	16							
		7.2 x Ir	11							

Thermal memory 20 minutes before and after tripping

S Short-time protection with fixed time delay

Pick-up (A) accuracy ±10 %	Isd = Ir x ...	1.5	2	3	4	5	6	7	8	10
Time delay (ms)	tsd	Non-adjustable								
	Non-tripping time	20								
	Maximum break time	80								

I Instantaneous protection

Pick-up (A) accuracy ±15 %	Ii non-adjustable	600	1500	2400	3000	4800	6900			
	Non-tripping time	10 ms								
	Maximum break time	50 ms								

[1] If the trip units are used in high-temperature environments, the MicroLogic setting must take into account the thermal limitations of the circuit breaker. See the temperature derating table.

MicroLogic 1.3 M

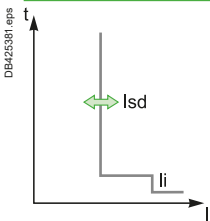

Ratings (A)	In at 65 °C [1]	320	500
Circuit breaker	ComPacT NSX400	●	-
	ComPacT NSX630	●	●

S Short-time protection

Pick-up (A) accuracy ±15 %	Isd	Adjustable directly in amps	
		9 settings: 1600, 1920, 2240, 2560, 2880, 3200, 3520, 3840, 4160 A	9 settings: 2500, 3000, 3500, 4000, 4500, 5000, 5500, 6000, 6500 A
Time delay (ms)	tsd	Non-adjustable	
	Non-tripping time	10	
	Maximum break time	60	

I Instantaneous protection

Pick-up (A) accuracy ±15 %	Ii non-adjustable	4800	6500
	Non-tripping time	0	
	Maximum break time	30 ms	

[1] Motor standards require operation at 65 °C. Circuit-breaker ratings are derated to take this requirement into account.

Protection of Distribution Systems

ComPacT NSX MicroLogic 5/6 E Trip Units

MicroLogic 5/6 E (Energy) trip units can be used on ComPacT NSX100 to 630 circuit breakers with performance levels B/F/H/N/S/L/R/HB1/HB2. They all have a display unit. They offer basic LSI protection (MicroLogic 5) or LSI and ground-fault protection G (MicroLogic 6). They also offer measurement, alarm and communication functions.



B

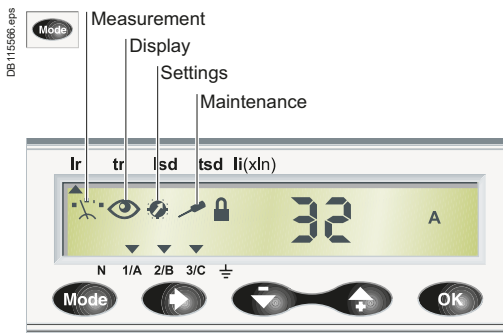

Trip unit menus

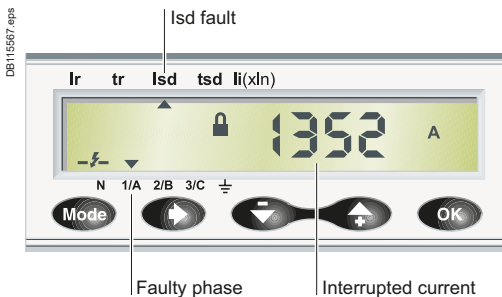

Display of interrupted current

Protection

Settings can be adjusted in two ways, using the dials and/or the keypad. The keypad can be used to make fine adjustments in 1 A steps below the maximum value defined by the setting on the dial. Access to setting modifications via the keypad is protected by a locking function displayed on the screen and controlled by a microswitch. The lock is activated automatically if the keypad is not used for 5 minutes. Access to the microswitch is protected by a transparent lead-sealable cover. With the cover closed, it is still possible to display the various settings and measurements using the keypad.

L Overloads: Long Time Protection (Ir)

Inverse time protection against overloads with an adjustable current pick-up **Ir** set using a dial or the keypad for fine adjustments. The time delay **tr** is set using the keypad.

S Short-Circuits: Short-Time Protection (Isd)

Short-circuit protection with an adjustable pick-up **Isd** and adjustable time delay **tsd**, with the possibility of including a portion of an inverse time curve (I²t On).

I Short-Circuits: Instantaneous Protection (Ii)

Instantaneous protection with adjustable pick-up **Ii**.

G Ground Fault Protection (Ig) on MicroLogic 6

Residual type ground-fault protection with an adjustable pick-up **Ig** (with Off position) and adjustable time delay **tg**. Possibility of including a portion of an inverse time curve (I²t On).

Neutral Protection

- On 4-pole circuit breakers, this protection can be set via the keypad:
 - Off: neutral unprotected
 - 0.5: neutral protection at half the value of the phase pick-up, i.e. 0.5 x Ir
 - 1.0: neutral fully protected at Ir
 - OSN: Oversized neutral protection at 1.6 times the value of the phase pick-up. Used when there is a high level of 3rd order harmonics (or orders that are multiples of 3) that accumulate in the neutral and create a high current. In this case, the device must be limited to Ir = 0.63 x In for the maximum neutral protection setting of 1.6 x Ir.
- With 3-pole circuit breakers, the neutral can be protected as an option by installing an external neutral sensor with the output (T1, T2) connected to the trip unit.

Zone Selective Interlocking (ZSI)

A ZSI terminal block may be used to interconnect a number of MicroLogic control units to provide zone selective interlocking for short-time (Isd) and ground-fault (Ig) protection, without a time delay. For ComPacT NSX 100 to 250, the ZSI function is available only in relation to the upstream circuit breaker (ZSI out).

Display of Type of Fault

On a fault trip, the type of fault (Ir, Isd, Ii, Ig), the phase concerned and the interrupted current are displayed. An external power supply is required.

Indications

Front Indications



- Green "Ready" LED: flashes slowly when the circuit breaker is ready to trip in the event of a fault.
- Orange overload pre-alarm LED: steady on when I > 90 % Ir.
- Red overload LED: steady on when I > 105 % Ir.

Remote Indications

An SDx relay module installed inside the circuit breaker can be used to remotely access to the following information:

- Overload trip
- Overload prealarm (MicroLogic 5) or ground fault trip (MicroLogic 6).

This module receives the signal from the MicroLogic electronic trip unit via an optical link and makes it available on the terminal block. The signal is cleared when the circuit breaker is closed.

These outputs can be reprogrammed to be assigned to other types of tripping or alarm. The module is described in detail in the section dealing with accessories.

Note: All the trip units have a transparent lead-sealable cover that avoids access to the adjustment dials.

Protection of Distribution Systems

ComPacT NSX MicroLogic 5/6 E Trip Units

MicroLogic 5/6 E Trip Units

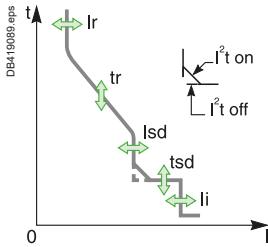

Ratings (A)	In at 40 °C [1]	40 [2]	100	160	250	400	630
Circuit breaker	ComPacT NSX100	●	●	-	-	-	-
	ComPacT NSX160	●	●	●	-	-	-
	ComPacT NSX250	●	●	●	●	-	-
	ComPacT NSX400	-	-	-	-	●	-
	ComPacT NSX630	-	-	-	-	●	●

L Long-time protection

Pick-up (A) tripping between 1.05 and 1.20 Ir	Ir = ...	Dial setting	Value depending on trip unit rating (In) and setting on dial									
	In = 40 A	Io =	18	18	20	23	25	28	32	36	40	
	In = 100 A	Io =	40	45	50	55	63	70	80	90	100	
	In = 160 A	Io =	63	70	80	90	100	110	125	150	160	
	In = 250 A	Io =	100	110	125	140	160	175	200	225	250	
	In = 400 A	Io =	160	180	200	230	250	280	320	360	400	
	In = 630 A	Io =	250	280	320	350	400	450	500	570	630	
		Keypad setting	Fine adjustment in 1 A steps below maximum value set on dial									
Time delay (s) accuracy 0 to -20 %	tr = ...	Keypad setting	0.5	1	2	4	8	16				
		1.5 x Ir	15	25	50	100	200	400				
		6 x Ir	0.5	1	2	4	8	16				
		7.2 x Ir	0.35	0.7	1.4	2.8	5.5	11				
Thermal memory			20 minutes before and after tripping									

S Short-time protection with adjustable time delay

Pick-up (A) accuracy ±10 %	Isd = Ir x ...	Dial setting for MicroLogic 5	1.5	2	3	4	5	6	7	8	10	
		Keypad settings for MicroLogic 6	Adjustment in steps of 0.5 x Ir over the range 1.5 x Ir to 10 x Ir									
Time delay (s)	tsd = ...	Keypad setting	I²Off	0	0.1	0.2	0.3	0.4				
		I²On	-	0.1	0.2	0.3	0.4					
	Non-tripping time (ms)			20	80	140	230	350				
	Maximum break time (ms)			80	140	200	320	500				

I Instantaneous protection

Pick-up (A) accuracy ±15 %	li = In x	Keypad setting	Adjustment in steps of 0.5 x In over the range 1.5 x In to: 15 x In (40 to 160 A), 12 x In (250 to 400 A) or 11 x In (630 A)									
	Non-tripping time		10 ms									
	Maximum break time		50 ms									

G Ground-fault protection - for MicroLogic 6 E

Pick-up (A) accuracy ±10 %	Ig = In x	Dial setting										
	In = 40 A		0.4	0.4	0.5	0.6	0.7	0.8	0.9	1	Off	
	In > 40 A		0.2	0.3	0.4	0.5	0.6	0.7	0.8	1	Off	
			Fine adjustment in 0.05 A steps using the keypad									
Time delay (s)	tg = ...	Keypad setting	I²Off	0	0.1	0.2	0.3	0.4				
		I²On	-	0.1	0.2	0.3	0.4					
	Non-tripping time (ms)			20	80	140	230	350				
	Maximum break time (ms)			80	140	200	320	500				
Test	Ig function		Built-in									

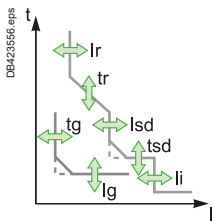

[1] If the trip units are used in high-temperature environments, the MicroLogic setting must take into account the thermal limitations of the circuit breaker. See the temperature derating table.

[2] For 40 A rating, the neutral N/2 adjustment is not possible.



Select Protection

Protection of Distribution Systems

ComPacT NSXm MicroLogic Vigi 4.1 Trip Unit with Integrated Earth Leakage Protection

ComPacT NSXm circuit breakers up to 160 A can be ordered with MicroLogic Vigi 4.1 trip unit with performance levels E/B/F/N/H.

They provide:

- Standard protection of distribution cables
- Earth leakage protection
- Indication of:
 - Overload alarming (via LEDs and via SDx module)
 - Overload tripping (via the SDx module)
 - Earth leakage alarming (via the SDx module)
 - Earth leakage tripping (via front face screen and the SDx module).

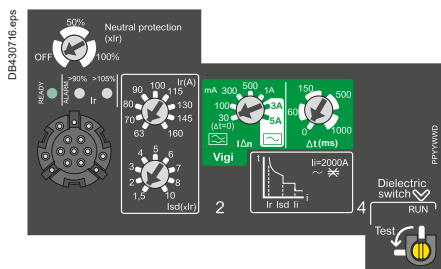

ComPacT NSXm MicroLogic Vigi 4.1

[1] On 100A and 160A circuit breakers only.

[2] If the sensitivity is set to 30 mA, there is no time delay, whatever the time-delay setting.

Note: All the trip units have a transparent lead-sealable cover that avoids access to the adjustment dials.

MicroLogic Vigi 4.1

Circuit breakers equipped with MicroLogic Vigi 4.1 trip units can be used for distribution systems supplied by transformers.

Short-Circuit and Overload Protection

Settings are made using the adjustment dials.

L Overloads: Long Time Protection (Ir)

Inverse time protection against overloads with a wide range adjustable current pick-up Ir set using a dial and a non-adjustable time delay tr.

S Short-Circuits: Short-Time Protection with Fixed Time Delay (Isd)

Protection with an adjustable pick-up Isd. Tripping takes place after a very short delay used to allow selectivity with the downstream device.

I Short-Circuits: Non-Adjustable Instantaneous Protection

Instantaneous short-circuit protection with a fixed pick-up.

Neutral Protection

- On 3-pole circuit breakers, neutral protection is not possible.
- On 4-pole circuit breakers, neutral protection may be set using a three-position switch:
 - OFF: neutral unprotected
 - 50 % [1]: neutral protection at half the value of the phase pick-up, i.e. 0.5 x Ir
 - 100 %: neutral fully protected at Ir

R Earth Leakage Protection

Protection with an adjustable leakage level (IΔn) with an adjustable delay (Δt).

Compliance with Standards

- IEC 60947-2, annex B.
- IEC 60755, class A, immunity to DC components up to 6 mA.
- Operation down to -25 °C as per VDE 664.

Power Supply

It is self-powered internally and therefore does not require any external source. It's still working even when supplied by only two phases.

Sensitivity IΔn (A)

- Type A: 30mA - 100mA - 300mA - 500mA - 1A.
- Type AC: 30mA - 100mA - 300mA - 1A - 3A - 5A.

Intentional Delay Δt (Ms)

0 - 60 [2] - 150 [2] - 500 [2] - 1000 [2].

Operated Voltage

200...440 V AC - 50/60 Hz.

Operating Safety

The earth leakage protection is a user safety device. It must be tested at regular intervals (every 6 months) using the test button.

Protection of Distribution Systems

ComPacT NSXm MicroLogic Vigi 4.1 Trip Unit with Integrated Earth Leakage Protection

Indications

Front Indications

- Green "Ready" LED: flashes slowly when the circuit breaker is ready to trip in the event of an overload or short-circuit fault.
- Orange overload pre-alarm LED: steady on when $I > 90\% I_r$.
- Red overload LED: steady on when $I > 105\% I_r$.
- Screen that indicate an earth leakage fault trip - reset when product is powered.

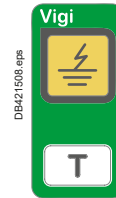
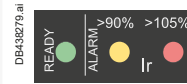

Alarming and Fault Differentiation

A side module SDx can be installed to provide alarming and fault differentiation:

- Overload alarm ($I > 105\% I_r$)
- Overload trip indication
- Earth leakage alarm ($I_{\Delta n} > 80\%$ threshold)
- Earth leakage trip indication.

This module receives the signal from the MicroLogic electronic trip unit via an optical link and makes it available on the terminal block through NO/NC dry contacts.

The signal is cleared when the circuit breaker is restarted.

For description, see page C-11.



MicroLogic Vigi 4.1

	Ratings (A)	I_n at 40 °C [1]	25	50	100	160					
	Circuit breaker	ComPacT NSXm	<input checked="" type="radio"/>	<input checked="" type="radio"/>	<input checked="" type="radio"/>	<input checked="" type="radio"/>					
L Long-time protection											
	Pick-up (A)	I_r	Value depending on trip unit rating (I_n) and setting on dial								
	tripping between 1.05 and 1.20 I_r	$I_n = 25\text{ A}$	$I_r = 10$	11	12	14	16	18	20	22	25
		$I_n = 50\text{ A}$	$I_r = 20$	22	25	28	32	36	40	45	50
		$I_n = 100\text{ A}$	$I_r = 40$	45	50	56	63	70	80	90	100
		$I_n = 160\text{ A}$	$I_r = 63$	70	80	90	100	115	130	145	160
	Time delay (s)	tr	Non-adjustable								
	accuracy 0 to -20%		1.5 x I_r	200							
			6 x I_r	8							
			7.2 x I_r	5							
	Thermal memory		20 minutes before and after tripping								
S₀ Short-time protection with fixed time delay											
	Pick-up (A)	Isd = $I_r \times \dots$	1.5	2	3	4	5	6	7	8	10
	accuracy $\pm 15\%$										
	Time delay (ms)	tsd	Non-adjustable								
		Non-tripping time	20								
		Maximum break time	80								
I Instantaneous protection											
	Pick-up (A)	li non-adjustable	375	750	1500	2000					
	accuracy $\pm 15\%$	Non-tripping time	10 ms			5 ms					
		Maximum break time	50 ms								
R Earth leakage protection											
	Sensitivity $I_{\Delta n}$ (A)	Adjustable	$I_{\Delta n} =$	0.03	0.1	0.3	0.5	1	3	5	
		Type		A and AC						AC	
	Time delay Δt (ms)	Adjustable	$\Delta t =$	0	60 [2]	150 [2]	500 [2]	1000 [2]			
		Maximum break time (ms)		< 40	< 140	< 300	< 800	< 1500			

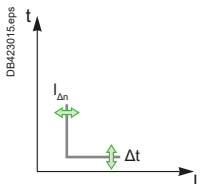
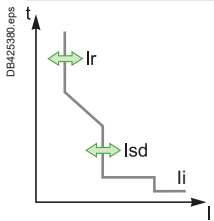

[1] If the circuit breakers are used in high-temperature environments, the setting must take into account the thermal limitations of the circuit breaker.

[2] If the sensitivity is set to 30 mA, there is no time delay, whatever the time-delay setting.

Protection of Distribution Systems

ComPacT NSX MicroLogic Vigi 4 Trip Unit with Integrated Earth Leakage Protection

The ComPacT NSX range is now complemented with a new type of MicroLogic trip unit including both circuit protection and earth leakage protection. It means that the earth leakage protection, previously located within the VigiPacT add-on, will be integrated within the existing size of the MicroLogic trip unit. MicroLogic Vigi 4 is compliant with IEC 60947-2 annex B.

B

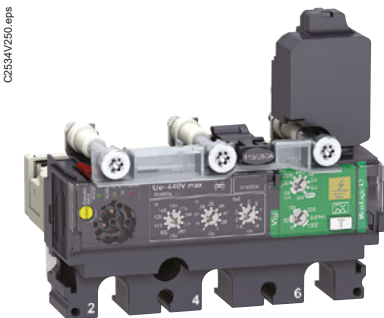

MicroLogic Vigi 4 (LS₀IR)

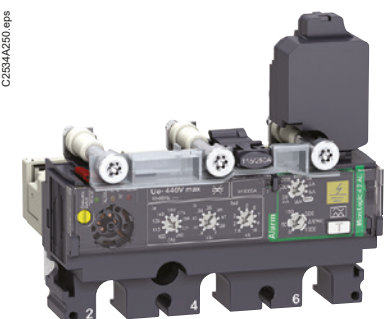

MicroLogic Vigi 4 AL (LS₀I + Earth Leakage Alarm)

MicroLogic Vigi 4

There are two versions of MicroLogic Vigi 4:

- Distribution protection including Earth Leakage Protection (LS₀IR)
- Distribution protection including Earth Leakage Alarm (LS₀I + Earth Leakage Alarm).

Protections

Settings are made using the rotary dial with fine adjustment capabilities.

Short Circuit and Overload Protections

L Overload: Long-Time Protection (I_r)

Inverse time protection against overload with an adjustable current pick-up I_r set using a dial and a non-adjustable time delay t_r.

S Short-Circuit: Short-Time Protection with Fixed Time Delay (I_{sd})

That protection is set with an adjustable pick-up I_{sd}. The tripping takes place after a very short time used to allow selectivity with downstream devices.

I Short Circuit: Non-Adjustable Instantaneous Protection

Instantaneous Short-Circuit Protection with a Fixed Pick-up.

Neutral Protection

- On a 3-pole device, neutral protection is not possible
- On a 4-pole device, neutral protection may be set using the dedicated coding wheel to meet the following configurations: 4P 3D, 4P 3D + N/2 or 4P 4D (same as for MicroLogic 2).

R Earth Leakage Protections

Adjustable leakage threshold (I_{Δn}) and adjustable time delay threshold (Dt) by using the two dials on the green area of the trip unit.

Power Supply

The trip unit is self supplied, and so does not need any external source. It works even when fed by 2 phases only.

Sensitivity I_{Δn} (A)

- Type A: 30mA - 100mA - 300mA - 500mA - 1A - 3A - 5A (for the ratings 40 to 250A)
- Type A: 300mA - 500mA - 1A - 3A - 5A - 10A (for the ratings 400 to 570A).

Caution: "OFF" setting of I_{Δn} is possible. It cancels the earth leakage protection, in that case, the circuit breaker with MicroLogic Vigi 4 behaves as a standard circuit breaker. That "OFF" position is located on the highest side of the coding wheel.

Intentional Delay I_{Δt} (S)

- Case I_{Δn} = 30mA: Δt 0 sec (whatever the setting)
- Case I_{Δn} > 30mA: Δt 0 – 60ms – 150ms – 500ms – 1sec (by setting)

Operated Voltage

200 to 440 VAC (only) – 50/60 Hz

Operating Safety

The earth leakage protection is a user safety device. It must be regularly tested using the test button (T) that simulates a real current leakage within the toroid. When I_{Δn} is set on the OFF position, press the T will cancel any test.

As for standard circuit breaker, the circuit breaker with MicroLogic Vigi 4 can be reset after any fault by operating an OFF/ON procedure.

Specific for the circuit breaker with MicroLogic Vigi 4 Alarm (AL), after testing as well as after a real leakage fault, it can be reset by pressing more than 3 seconds the test button (T), to avoid switching OFF the device.

Protection of Distribution Systems

ComPacT NSX MicroLogic Vigi 4 Trip Unit with Integrated Earth Leakage Protection

Indications

Front Indications

- Green "Ready" LED: flashes slowly when the circuit breaker is ready to trip in case of a fault.
- Orange overload pre-alarm LED: steady ON when $I > 90\% I_r$.
- Red overload LED: steady ON when $I > 105\% I_r$.
- Yellow Screen: indicates an earth leakage fault (reset when operating OFF/ON for the "trip" or when pressing >3sec the T button for the Alarm).

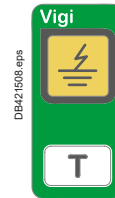
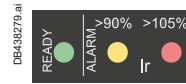

Alarming and Fault Differentiation

- An overload trip signal can be remotely available by installing an SDx relay module inside the circuit breaker on both "trip" and "alarm" versions.
- An earth leakage trip signal can be remotely available by installing an SDx module, only on the "trip" version.
- An earth leakage alarm signal (MicroLogic Vigi 4 AL) can be remotely available on the SDx, for the circuit breaker with MicroLogic Vigi 4 alarm".

This module receives the signal from the MicroLogic trip unit via an optical link and makes it available on the terminal block. The signal is reset when the breaker is operated.

MicroLogic Vigi 4

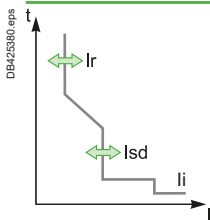

Ratings (A)	In at 40 °C [1]	40	100	160	250	400	570
Circuit breaker	ComPacT NSX100	●	●				
	ComPacT NSX160	●	●	●			
	ComPacT NSX250	●	●	●	●		
	ComPacT NSX400					●	
	ComPacT NSX630					●	●

L Long-time protection

Pick-up (A) tripping between 1.05 and 1.20 I _r	In = 40 A	lo = 18	18	20	23	25	28	32	36	40
	In = 100 A	lo = 40	45	50	55	63	70	80	90	100
	In = 160 A	lo = 63	70	80	90	100	110	125	150	160
	In = 250 A	lo = 100	110	125	140	160	175	200	225	250
	In = 400 A	lo = 160	180	200	230	250	280	320	360	400
	In = 570 A	lo = 250	280	320	350	400	450	500	570	570
	I _r = lo x	9 fine adjustment settings from 0.9 to 1 (0.9 – 0.92 ... 0.98 - 1)								
Time delay (s) accuracy 0 to -20%	tr	Non-adjustable								
	at	1.5 x I _r	tr = 400 s							
	at	6 x I _r	tr = 16 s							
	at	7.2 x I _r	tr = 11 s							
Thermal memory		20 minutes before and after tripping								

S₀ Short-time protection with fixed time delay

Pick-up (A) accuracy ±10 %	I _{sd} = I _r x ...	1.5	2	3	4	5	6	7	8	10
Time delay (ms)	tsd	Non-adjustable								
	Non-tripping time	20								
	Maximum break time	80								

I Instantaneous protection

Pick-up (A) accuracy ±15 %	I _{li} non-adjustable	600	1500	2400	3000	4800	6900			
	Non-tripping time	10 ms								
	Maximum break time	50 ms								

R Earth leakage protection/Earth leakage alarm

Sensitivity (A)	Type A, adjustable (9 positions)									
	In = 40 A	IΔn = 0.03	0.03	0.1	0.3	0.5	1	3	5	OFF
	In = 100 A	IΔn = 0.03	0.03	0.1	0.3	0.5	1	3	5	OFF
	In = 160 A	IΔn = 0.03	0.03	0.1	0.3	0.5	1	3	5	OFF
	In = 250 A	IΔn = 0.03	0.03	0.1	0.3	0.5	1	3	5	OFF
	In = 400 A	IΔn = 0.3	0.3	0.5	1	3	5	10	10	OFF
	In = 570 A	IΔn = 0.3	0.3	0.5	1	3	5	10	10	OFF
Time delay Δt (ms)	Adjustable	Δt = 0	60 [2]	150 [2]	500 [2]	1000 [2]				
	Maximum break time (ms)	<40	<140	<300	<800	<1500	ms			

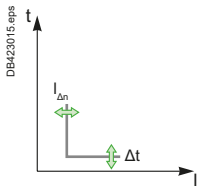

[1] For the use in high temperature environment, take into account the thermal limitation of the breaker.

[2] The time delay (Δt) is mandatory and forced to "Δt = 0" when the IΔn dial is set on 30mA (0.03). The time delay has no effect when the dial IΔn is set to the "OFF" position.

Protection of Distribution Systems

ComPacT NSX MicroLogic Vigi 7 E Trip Unit with Integrated Earth Leakage Protection

The ComPacT NSX range is now complemented with a new type of MicroLogic trip unit including circuit protection, metering and earth leakage protection. It means that the earth leakage protection, previously located within the VigiPacT add-on, will be integrated within the existing size of the MicroLogic trip unit. MicroLogic Vigi 7 E is compliant with IEC 60947-2 annex B.

B

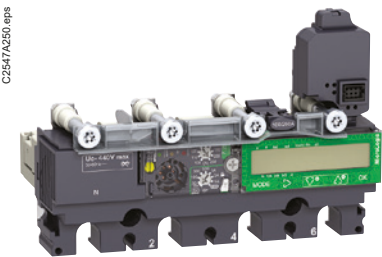

MicroLogic Vigi 7 E (LSIR)

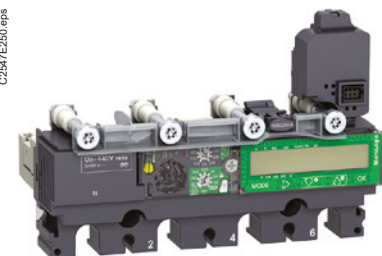

MicroLogic Vigi 7 E AL (LSI + Earth Leakage Alarm)

MicroLogic Vigi 7 E

There are two versions of MicroLogic Vigi 7 E:

- Distribution protection including Earth Leakage Protection (LSIR)
- Distribution protection including Earth Leakage Alarm (LSI + Earth Leakage Alarm).

Locking Protection - Parameter Settings

Settings are made using the rotary dial or/and the keypad. The protection parameter settings are locked when the transparent cover is closed and sealed to avoid access to the adjustment dials and the locking/unlocking microswitch. But you can display the various parameters using the keypad even when the cover is closed (and sealed).

Short Circuit and Overload Protections

L Overload: Long Time Protection (I_r)

Inverse time protection against overload with an adjustable current pick-up I_r set using the dial or the keypad for fine adjustments. The adjustable time delay t_r is set using the keypad only.

S Short-Circuit: Short Circuit Protection (I_{sd})

That protection is with an adjustable pick-up I_{sd} and an adjustable time delay t_{sd} . It is possible to include a portion of an inverse time curve (I^2t On).

I Short-Circuit: Instantaneous Protection (I_i)

Instantaneous protection with an adjustable protection pick-up I_i .

Neutral Protection

- On a 4-pole device, the neutral protection may be set using the dedicated coding wheel to meet the following configurations: 4P 3D, 4P 3D + N/2 or 4P 4D (same as for MicroLogic 5).
- OSN (Oversized Neutral Protection) at 1.6 times the phase pick-up value; useful where there is an high level of 3rd order harmonics (or multiple of 3) that create an over-current within the neutral. In that case the device has to be limited to $I_r = I_n \times 0.63$ (for each phase) to allow the neutral protection setting to 1.6 x I_r .

R Earth Leakage Protections

Adjustable leakage threshold ($I_{\Delta n}$) using the dial only (without any use of the keypad for fine-tuning) and an adjustable time delay threshold (Δt) using the keypad only.

Power Supply

The MicroLogic trip unit is powered with its own current for continuous protection functions.

If there is no optional external 24 VDC power supply, the MicroLogic trip unit only works when the circuit breaker is closed. When the circuit breaker is open or the through current is low (15 to 50 A depending on the rating), the MicroLogic trip unit is no longer powered and its display switches off.

An external 24 VDC power supply for the MicroLogic trip unit is optional for:

- Modifying the setting values when the circuit breaker is open
- Displaying measurements when there is a low current through the circuit breaker (15 to 50 A depending on the rating) when the circuit breaker is closed
- Continuing to display the reason for the trip and the breaking current when the circuit breaker is open.

Sensitivity $I_{\Delta n}$ (A)

- Type A: 30mA - 100mA - 300mA - 500mA - 1A - 3A - 5A (for the ratings 40 to 250A)
- Type A: 300mA - 500mA - 1A - 3A - 5A - 10A (for the ratings 400 to 570A)

Caution: "OFF" setting of $I_{\Delta n}$ is possible, it cancels the earth leakage protection, in that case, the circuit breaker with MicroLogic Vigi 4 behaves as a standard circuit breaker. "OFF" position is located on the highest side of the coding wheel.

Protection of Distribution Systems

ComPacT NSX MicroLogic Vigi 7 E Trip Unit with Integrated Earth Leakage Protection

Intentional Delay $I\Delta t$ (S)

- Case $I\Delta n = 30\text{mA}$: Δt 0 sec
- Case $I\Delta n > 30\text{mA}$: Δt 0 – 60ms – 150ms – 500ms – 1sec

Operated Voltage

200 to 440 VAC (only) – 50/60 Hz

Operating Safety

The earth leakage protection is a user safety device. It must be regularly tested using the test button (T) that simulates a real current leakage within the toroid. When $I\Delta n$ is set on the OFF position, press the T will cancel any test. As for the standard circuit breaker, the circuit breaker with MicroLogic Vigi 7 E ("Trip" or "Alarm" version) can be reset after any fault by using the keypad.

The MicroLogic Vigi 7 E allows you to set-up a specific "(T) test without tripping" procedure using the keypad.

Display of the Type of Fault

On a trip, the root cause of the fault (phase and interrupted current) are displayed. An external power supply is needed for this function.

Select Protection

Protection of Distribution Systems

ComPacT NSX MicroLogic Vigi 7 E Trip Unit with Integrated Earth Leakage Protection



B

Indications

Front Indication

- Green "Ready" LED: flashes slowly when the circuit breaker is ready to trip in case of a fault.
- Orange overload pre-alarm LED: steady ON when $I > 90\% I_r$.
- Red overload LED: steady ON when $I > 105\% I_r$.

Written on keypad: earth leakage fault indication (reset using the keypad) for both "Trip" and "Alarm".

Alarming and Fault Differentiation

An SDx relay module can be installed inside the earth leakage circuit breaker to remotely access to the following data:

- Overload pre-Alarm
- Overload trip
- Earth leakage pre-alarm (useful for the "trip" version of the circuit breaker with MicroLogic Vigi 7 E only)
- Earth leakage trip (exist for the "trip" version of the circuit breaker with MicroLogic Vigi 7 E only)
- Earth leakage Alarm without "trip" (circuit breaker with MicroLogic Vigi 7 E AL version only).

This module receives the signal from the MicroLogic electronic trip unit via an optical link and makes it available on the terminal block. The signal is reset when the breaker is operated.

These outputs can be reprogrammed to be assigned to other types of tripping or alarm. The module is deeper described in the section dealing with accessories.

Protection of Distribution Systems

ComPacT NSX MicroLogic Vigi 7 E Trip Unit with Integrated Earth Leakage Protection

MicroLogic Vigi 7 E

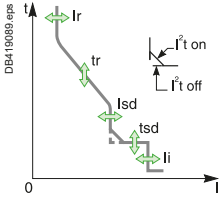

Ratings (A)	In at 40 °C [1]	40 [2]	100	160	250	400	570
Circuit breaker	ComPacT NSX100	●	●				
	ComPacT NSX160	●	●	●			
	ComPacT NSX250	●	●	●	●		
	ComPacT NSX400					●	
	ComPacT NSX630					●	●

L Long-time protection

Pick-up (A)	Dial setting	Value depending on the rating (In) and the dial setting									
tripping between 1.05 and 1.20 Ir	Ir	In = 40 A	Io = 18	18	20	23	25	28	32	36	40
	In = 100 A	Io = 40	45	50	55	63	70	80	90	100	
	In = 160 A	Io = 63	70	80	90	100	110	125	150	160	
	In = 250 A	Io = 100	110	125	140	160	175	200	225	250	
	In = 400 A	Io = 160	180	200	230	250	280	320	360	400	
	In = 570 A	Io = 250	280	320	350	400	450	500	570	570	
Time delay (s) accuracy 0 to -20%	Keypad setting	Fine adjustment in 1A step below the max value set on the dial									
	tr	Keypad setting	0.5	1	2	4	8	16			
		at 1.5 x Ir	15	25	50	100	200	400			
		at 6 x Ir	0.5	1	2	4	8	16			
		at 7.2 x Ir	0.35	0.7	1.4	2.8	5.5	11			
Thermal memory	20 minutes before and after tripping										

S Short-time protection with adjustable time delay

Pick-up (A) accuracy ±10 %	Isd = Ir x ... keypad settings	Adjustment in steps of 0.5 x Ir over the range 1.5 x Ir to 10 x Ir									
Time delay (ms)	tsd	I ² Of	0	0.1	0.2	0.3	0.4				
	Keypad	I ² On	-	0.1	0.2	0.3	0.4				
	Non-tripping time (ms)		20	80	140	230	350				
	Maximum break time		80	140	200	320	500				

I Instantaneous protection

Pick-up (A) accuracy ±15 %	Ii = In x	Adjustment in steps of 0.5 x In over the range 1.5 x In to:									
	Keypad settings	15 x In (40 to 160A), 12 x In (250 to 400A), or 12 x In (570A)									
	Non-tripping time	10 ms									
	Maximum break time	50 ms									

R Earth leakage protection/Earth leakage alarm

Sensitivity (A)	Type A, adjustable (9 positions)										
	In = 40 A	IΔn = 0.03	0.03	0.1	0.3	0.5	1	3	5	OFF	
	In = 100 A	IΔn = 0.03	0.03	0.1	0.3	0.5	1	3	5	OFF	
	In = 160 A	IΔn = 0.03	0.03	0.1	0.3	0.5	1	3	5	OFF	
	In = 250 A	IΔn = 0.03	0.03	0.1	0.3	0.5	1	3	5	OFF	
	In = 400 A	IΔn = 0.3	0.3	0.5	1	3	5	10	10	OFF	
Time delay Δt (ms)	In = 570 A	IΔn = 0.3	0.3	0.5	1	3	5	10	10	OFF	
	Adjustable keypad Δt =	0	60 [3]	150 [3]	500 [3]	1000 [3]					
	Maximum break time (ms)	<40	<140	<300	<800	<1500					

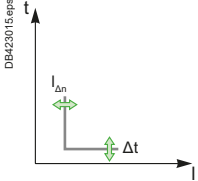

[1] For the use in high temperature environment, take into account the thermal limitation of the breaker.
 [2] For the rating 40A, the N/2 adjustment is not possible
 [3] The time delay (Δt) is mandatory and designed "Δt = 0" when the IΔn dial is set on 30mA (0.03). The time delay has no effect when the dial IΔn is set to the "OFF" position.



Select Protection

Protection of Distribution Systems

ComPacT NSX VigiPacT Add-on

Protection Against Insulation Faults

There are three ways to add earth-leakage protection and alarm to any three pole or four pole ComPacT NSX circuit breaker equipped with magnetic, thermal-magnetic or Micrologic 2, 5, 6 trip units:

- Upgrade the existing trip unit without changing the basic frame to embedded earth-leakage protection by using Micrologic 4 or 7 trip units.
- Add a VigiPacT add-on to the circuit breaker.
- Use an external VigiPacT relay and separate toroids.



ComPacT NSX and MicroLogic 4 and 7



ComPacT NSX and VigiPacT add-on

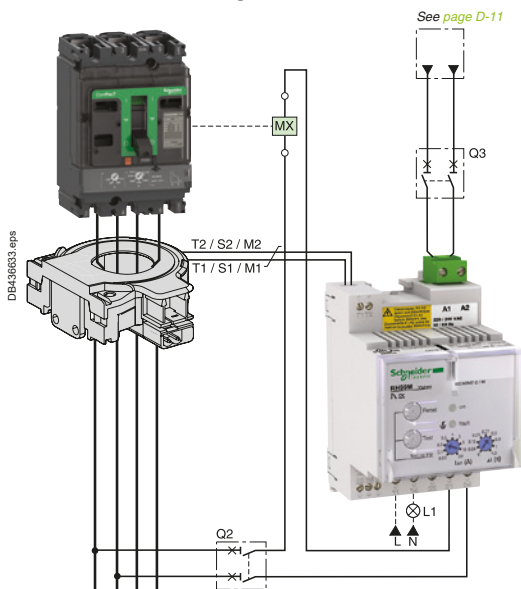

ComPacT NSX with VigiPacT external relay and toroid

Circuit Breaker with Embedded Earth-Leakage Protection Micrologic 4&7

Earth leakage protection integrated within the existing size of the Micrologic trip unit and compliant with IEC 60947-2 annex B.

Circuit Breaker with VigiPacT Add-on

- For general characteristics of circuit breakers, see pages A-6 and A-7
- VigiPacT add-on

Earth-leakage protection is achieved by installing a VigiPacT add-on (characteristics and selection criteria on next page) directly on the circuit breaker terminals. It directly actuates the trip unit (magnetic, thermal-magnetic or MicroLogic).

ComPacT NSX Circuit Breaker with a VigiPacT Relay

VigiPacT relays may be used to add external earth-leakage protection to ComPacT NSX circuit breakers.

The circuit breakers must be equipped with an MN or MX voltage release.

The VigiPacT relays add special tripping thresholds and time delays for earth-leakage protection.

VigiPacT relays are very useful when faced with major installation constraints (circuit breaker already installed and connected, limited space available, etc.).

VigiPacT relay characteristics

- Sensitivity adjustable from 30 mA to 30 A and time-delay settings (0 to 4.5 seconds)
- Closed toroids up to 630 A (30 to 300 mm in diameter), opened toroids up to 250 A (80 to 120 mm in diameter) or rectangular sensors up to 630 A
- 50/60 Hz distribution systems

Options

- Trip indication by a fail-safe contact
- Pre-alarm contact and LED, etc.

Compliance with standards

- IEC 60947-2, annex M
- IEC/EN 60755: general requirements for residual-current operated protective devices
- IEC/EN 61000-4-2 to 4-6: immunity tests
- CISPR 11: Industrial, scientific and medical equipment - Radio-frequency disturbance characteristics - Limits and methods of measurement
- UL 1053 and CSA22.2 No. 144 for RH10, RH21 and RH99 relays at supply voltages up to and including 220/240 V

Protection of Distribution Systems

ComPacT NSX VigiPacT Add-on

Protection Against Insulation Faults

ComPacT NSX VigiPacT Add-on

Addition of the VigiPacT add-on does not modify circuit-breaker characteristics:

- Compliance with standards
- Degree of protection, class II front-face insulation
- Positive contact indication
- Electrical characteristics
- Trip unit characteristics
- Installation and connection modes
- Indication, measurement and control auxiliaries
- Installation and connection accessories.

Dimensions and weights		NSX100/160/250	NSX400/630
Dimensions	3 poles	105 x 236 x 86	140 x 355 x 110
W x H x D (mm)	4 poles	140 x 236 x 86	185 x 355 x 110
Weight (kg)	3 poles	2.5	8.8
	4 poles	3.2	10.8

Compliance with standards

- IEC 60947-2, annex B
- IEC 60755, Type A, immunity to DC components up to 6 mA
- Operation down to -25 °C as per VDE 664

Remote indications

VigiPacT add-on may be equipped with an auxiliary contact (SDV) to remotely signal tripping due to an earth fault.

Use of 4-pole VigiPacT add-on with a 3-pole ComPacT NSX

In a 3-phase installation with an uninterrupted neutral, an accessory makes it possible to use a 4-pole VigiPacT add-on with connection of the neutral cable.

Power supply

VigiPacT add-on are self-powered internally by the distribution-system voltage and therefore do not require any external source. They continue to function even when supplied by only two phases.

ComPacT NSX VigiPacT Add-on		
Type	Protection	Alarm
Number of poles	3, 4	3, 4
Ratings (A)	100, 160, 250, 400, 630	100, 160, 250, 400, 630
IΔn (A) Class A	0.03, 0.1, 0.3, 0.5, 1, 3 (0.03, 0.06, 0.25, 0.375, 0.5, 3) ^[1]	0.03, 0.1, 0.3, 0.5, 1, 3 -
IΔn (A) Class AC	10, 30	10, 30
Time delay (ms)	0, 60, 150, 300, 500, 800, 1.2s, 4s	no settings 0 ms
Max break time (ms)	<40 ^[2] <150 ^[2] <500 <800 <1.2s <5s	-
Rated voltages V AC 50/60Hz	200 - 550	200 - 440

[1] Special settings for South Africa.

[2] Max break time according to IEC 60947-2 Annex B Clause B.4.2.4.

Longer time (<+20ms) may be experienced in case of closing on residual current (Clause B.8.2.4.5).



PE121561.eps

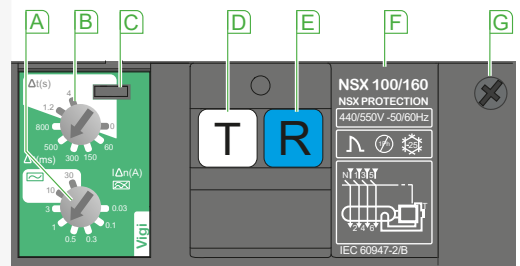

DE438280.ai



- A** Sensitivity setting
- B** Time-delay setting (for selective earth-leakage protection)
- C** Lead-seal fixture for controlled access to settings
- D** Test button simulating an earth-fault for regular checks on the tripping function
- E** Reset button (reset required after earth-fault tripping)
- F** Rating plate
- G** Housing for SDV auxiliary contact

Plug-in devices

The VigiPacT add-on can be installed on a plug-in base. Special accessories are required (see Catalog Numbers chapter).

Select Protection

Protection of Distribution Systems

ComPacT NSX and NSXm

Protection Against Insulation Faults Using a VigiPacT Relay

Detection

with Associated Toroid



Alarm

with the VigiPacT Relay

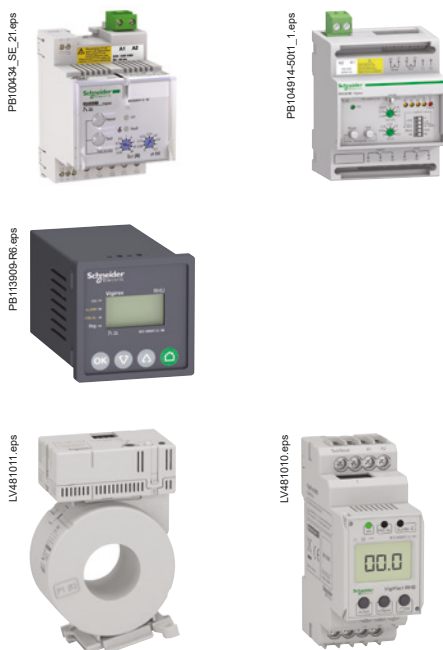

Function

VigiPacT relays measure the earth-leakage current in an electrical installation via their associated toroids.

VigiPacT relays may be used for:

- Residual-current protection (RH10, RH21, RH68, RH86, RH99, and RHB)
- Earth-leakage monitoring (RMH or RH99, and RHB)
- Residual-current protection and earth-leakage monitoring (RH197, RHUs, RHU, and RHB).

Residual-Current Protection Relay

Protection relays control the interruption of the supply of power to the monitored systems to help protect:

- People against indirect contact and, in addition, against direct contact
- Property against fire hazards
- Motors.

A relay trips the associated circuit breaker when the set residual operating current $I_{\Delta n}$ is overrun.

Depending on the relay, the threshold $I_{\Delta n}$ can be fixed, user-selectable or adjustable and the overrun can be signalled by a digital display of the measured current or a LED.

The leakage current is displayed:

- For the RH197, on a bargraph made up of 4 LEDs indicating levels corresponding to 20, 30, 40 and 50 % of $I_{\Delta n}$
- For the RHUs and RHU, by digital display of the value of the leakage current.

Circuit breaker tripping can be either instantaneous or delayed. On some relays, it is possible to adjust the time delay.

The protection relays store the residual-current fault in memory. Once the fault has been cleared and the output contact has been manually reset, the relay can be used again.

Earth-Leakage Monitoring Relays

These relays may be used to monitor drops in electrical insulation due to ageing of cables or extensions in the installation.

Continuous measurement of leakage currents makes it possible to plan preventive maintenance on the faulty circuits. An increase in the leakage currents may lead to a complete shutdown of the installation.

The control signal is issued by the relay when the residual-current operating threshold is overrun.

Depending on the relay, the threshold can be adjustable or user-selectable and the overrun can be signalled via a LED, a bargraph or a digital display of the measured current.

The leakage current is displayed:

- For the RH197, on a bargraph made up of 4 LEDs indicating levels corresponding to 20, 30, 40 and 50 % of $I_{\Delta n}$
- For the RMH, by digital display of the value of the leakage current.

The control signal can be either instantaneous or delayed. On some relays, it is possible to adjust the time delay.

Earth-leakage monitoring relays do not store the residual-current fault in memory and their output contact is automatically reset when the fault is cleared.

Use

VigiPacT relays may be used for protection and maintenance at all levels in the installation. Depending on the relays, they may be used in TT, IT or TNS low-voltage AC installations for voltages up to 1000 V and frequencies 50/60 Hz. VigiPacT protection relays are suitable for use with all electrical switchgear devices available on the market.

Protection of Distribution Systems





ComPacT NSX and NSXm

Protection Against Insulation Faults Using a VigiPacT Relay

Developed to be suitable for all installation systems, the VigiPacT range provides real simplicity of choice and assembly.

Overview of the VigiPacT Range





Protection and Monitoring Relays

Device					
	RH10M&P	RH21M&P	RH68M&P	RH86M&P	RHUs/RHU
Functions					
Protection	●	●	●	●	●
Monitoring	-	-	-	-	●
Local indications	●	●	●	●	●
Type					
A	up to 5 A	up to 5 A	up to 5 A	up to 5 A	up to 5 A
AC	●	●	●	●	●
Remote indications					
Hard-wired	●	●	●	●	●
Via com Modbus SL	-	-	-	-	● Except RHUs
Display of measurement	●	●	●	●	●

B

Protection and Monitoring Relays

Centralized Monitoring Relay

Device					
	RH99M&P	RH197M&P	RHB	RMH	RM12T
Functions					
Protection	-	●	●	-	-
Monitoring	●	●	-	●	●
Local indications	●	●	●	●	●
Type					
A	up to 5 A	up to 5 A	up to 5 A	up to 5 A	up to 5 A
AC	●	●	●	●	●
B	-	-	●	-	-
Remote indications					
Hard-wired	●	●	-	●	●
Via communication	-	-	● Except RHUs	●	●
Display of measurement	●	●	●	● 12 measurement channels	●

Formats for All Installation Systems

Schneider MCB format devices in the VigiPacT range can be mounted on a DIN rail (RH10, RH21, RH99 and RH197) or on a universal mounting plate using mounting lugs (RH10, RH21 and RH99). The 72 x 72 mm front-panel mount devices (RH10, RH21, RH99, RH197, RMH, RHUs and RHU) are mounted on panels, doors or front plates using clips.

Installation System	Suitable Format	
	Front-panel mount	DIN rail
Main LV switchboard	●	
Power distribution switchboard	Instrument zone	
	Modular-device zone	●
Motor Control Centre (MCC)		● With clip-in toroid
Automatic control panel or machine panel		● With mounting lugs
Final distribution enclosures		●

ComPacT NSX Motor Protection

General Information on Motor Feeders

B

The parameters to be considered for motor-feeder protection depend on:

- The application (type of machine driven, operating safety, frequency of operation, etc.)
- The level of continuity of service required by the load or the application
- The applicable standards for the protection of life and property.

The required electrical functions are:

- Isolation
- Switching, generally at high endurance levels
- Protection against overloads and short-circuits, adapted to the motor
- Additional special protection

A motor feeder must comply with the requirements of standard IEC 60947-4-1 concerning contactors and their protection:

- Coordination of feeder components
- Thermal-relay trip classes
- Contactor utilization categories
- Coordination of insulation

Motor-Feeder Function

A motor feeder comprises a set of devices for motor protection and control, as well as for protection of the feeder itself.

Isolation

The purpose is to isolate the live conductors from the upstream distribution system to enable work by maintenance personnel on the motor feeder at no risk. This function is provided by a motor circuit breaker offering positive contact indication and lockout/tagout possibilities.

Switching

The purpose is to control the motor (ON/OFF), either manually, automatically or remotely, taking into account overloads upon start-up and the long service life required. This function is provided by a contactor. When the coil of the contactor's electromagnet is energized, the contactor closes and establishes, through the poles, the circuit between the upstream supply and the motor, via the circuit breaker.

Basic Protection

- Short-circuit protection
Detection and breaking, as quickly as possible, of high short-circuit currents to avoid damage to the installation. This function is provided by a magnetic or thermal-magnetic circuit breaker.
- Overload protection
Detection of overload currents and motor shutdown before temperature rise in the motor and conductors damages insulation. This function is provided by a thermal-magnetic circuit breaker or a separate thermal relay.

Overloads: $I < 10 \times I_n$

They are caused by:

- An electrical problem, related to an anomaly in the distribution system (e.g. phase failure, voltage outside tolerances, etc.)
- A mechanical problem, related to a process malfunction (e.g. excessive torque) or damage to the motor (e.g. bearing vibrations).

These two causes will also result in excessively long starting times.

Impedant short-circuits: $10 \times I_n < I < 50 \times I_n$

This type of short-circuit is generally due to deteriorated insulation of motor windings or damaged supply cables.

Short-circuits: $I > 50 \times I_n$

This relatively rare type of fault may be caused by a connection error during maintenance.

- Phase unbalance or phase loss protection
Phase unbalance or phase loss can cause temperature rise and braking torques that can lead to premature ageing of the motor. These effects are even greater during starting, therefore protection must be virtually immediate.

Additional Electronic Protection

- Locked rotor
- Under-load
- Long starts and stalled rotor
- Insulation faults

Motor-Feeder Solutions

IEC 60947 defines three types of device combinations for the protection of motor feeders.

Three devices

- Magnetic circuit breaker + contactor + thermal relay

Two devices

- Thermal-magnetic circuit breaker + contactor

One device

- Thermal-magnetic circuit breaker + contactor in an integrated solution (e.g. TeSys U)

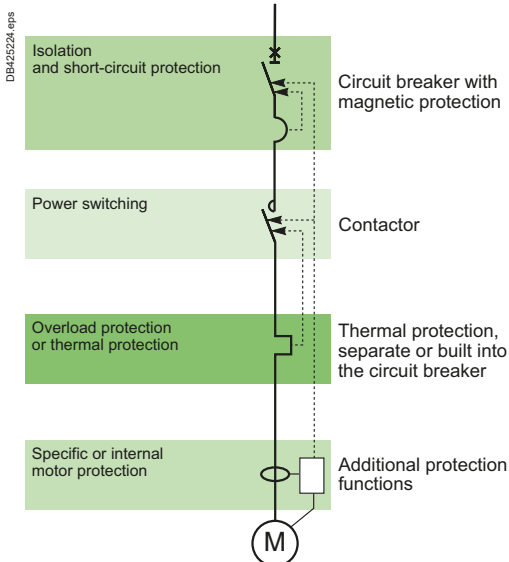
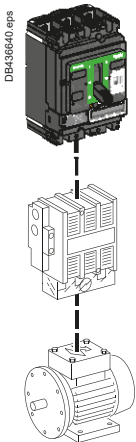

Switchgear functions in a motor feeder

ComPacT NSX Motor Protection

General Information on Motor Feeders



Device Coordination

The various components of a motor feeder must be coordinated. Standard IEC 60947-4-1 defines three types of coordination depending on the operating condition of the devices following a standardized short-circuit test.

Type 1 coordination

- No danger to life or property
- The contactor and/or the thermal relay may be damaged
- Repair and replacement of parts may be required prior to further service

Type 2 coordination

- No danger to life or property
- No damage or adjustments are allowed. The risk of contact welding is accepted as long as they can be easily separated
- Isolation must be maintained after the incident, the motor feeder must be suitable for further use without repair or replacement of parts
- A rapid inspection is sufficient before return to service

Total coordination

No damage and no risk of contact welding is allowed for the devices making up the motor feeder. The motor feeder must be suitable for further use without repair or replacement of parts.

This level is provided by integrated 1-device solutions such as TeSys U.

Contactor Utilization Categories

For a given motor-feeder solution, the utilization category determines the contactor withstand capacity in terms of frequency of operation and endurance. Selection, which depends on the operating conditions imposed by the application, may result in oversizing the contactor and circuit-breaker protection. IEC 60947 defines the following contactor utilization categories.

Contactor utilization categories (AC current)

Contactor utilization categories	Type of load	Control function	Typical applications
AC-1	Non-inductive ($\cos \varphi \geq 0.8$)	Energizing	Heating, distribution
AC-2	Slip-ring motor ($\cos \varphi \geq 0.65$)	Starting Switching off motor during running Counter-current braking Inching	Wiring-drawing machine
AC-3	Squirrel-cage motor ($\cos \varphi = 0.45$ for ≤ 100 A) ($\cos \varphi = 0.35$ for > 100 A)	Starting Switching off motor during running	Compressors, elevators, pumps, mixers, escalators, fans, conveyer systems, air-conditioning
AC-4		Starting Switching off motor during running Regenerative braking Plugging Inching	Printing machines, wire-drawing machines

Utilization category AC-3 - common coordination tables for circuit breakers and contactors

This category covers asynchronous squirrel-cage motors that are switched off during running, which is the most common situation (85 % of cases). The contactor makes the starting current and switches off the rated current at a voltage approximately one sixth of the nominal value. The current is interrupted without difficulty.

The circuit breaker-contactor coordination tables for ComPacT NSX are for use with contactors in the AC-3 utilization category, in which case they ensure type 2 coordination.

Utilization category AC-4 - possible oversizing

This category covers asynchronous squirrel-cage motors capable of operating under regenerative braking or inching (jogging) conditions

The contactor makes the starting current and can interrupt this current at a voltage that may be equal to that of the distribution system.

These difficult conditions make it necessary to oversize the contactor and, in general, the protective circuit breaker with respect to category AC-3.

ComPacT NSX Motor Protection

Motor-Feeder Characteristics and Solutions

The trip class determines the trip curve of the thermal protection device (inverse-time curve) for a motor feeder. Standard IEC 60947-4-1 defines trip classes 5, 10, 20 and 30. These classes are the maximum durations, in seconds, for motor starting with a starting current of 7.2 I_r, where I_r is the thermal setting indicated on the motor rating plate.

Example: In class 20, the motor must have finished starting within 20 seconds (6 to 20 s) for a starting current of 7.2 I_r.

Trip Class of a Thermal-Protection Device

The motor feeder includes thermal protection that may be built into the circuit breaker. The protection must have a trip class suited to motor starting. Depending on the application, the motor starting time varies from a few seconds (no-load start) to a few dozen seconds (high-inertia load). Standard IEC 60947-4-1 defines the trip classes below as a function of current setting I_r for thermal protection.

Trip class of thermal relays as a function of their I_r setting

Class	1.05 I _r [1]	1.2 I _r [1]	1.5 I _r [2]	7.2 I _r [1]
5	t > 2 h	t < 2h	t < 2 mn	2 s < t ≤ 5 s
10	t > 2 h	t < 2h	t < 4 mn	4 s < t ≤ 10 s
20	t > 2 h	t < 2h	t < 8 mn	6 s < t ≤ 20 s
30	t > 2 h	t < 2h	t < 12 mn	9 s < t ≤ 30 s

[1] Time for a cold motor (motor off and cold).

[2] Time for warm motor (motor running under normal conditions).

Currents of Squirrel-Cage Motors at Full Rated Load

Standardized values in HP

Rated operational power hp	Indicative values of the rated operational currents I _e (A) for						
	110 - 120 V	200 V	208 V	220 - 240 V	380 - 415 V	440 - 480 V	550 - 600 V
1/2	4.4	2.5	2.4	2.2	1.3	1.1	0.9
3/4	6.4	3.7	3.5	3.2	1.8	1.6	1.3
1	8.4	4.8	4.6	4.2	2.3	2.1	1.7
1 1/2	12	6.9	6.6	6	3.3	3	2.4
2	13.6	7.8	7.5	6.8	4.3	3.4	2.7
3	19.2	11	10.6	9.6	6.1	4.8	3.9
5	30.4	17.5	16.7	15.2	9.7	7.6	6.1
7 1/2	44	25.3	24.2	22	14	11	9
10	56	32.2	30.8	28	18	14	11
15	84	48.3	46.2	42	27	21	17
20	108	62.1	59.4	54	34	27	22
25	136	78.2	74.8	68	44	34	27
30	160	92	88	80	51	40	32
40	208	120	114	104	66	52	41
50	260	150	143	130	83	65	52
60	-	177	169	154	103	77	62
75	-	221	211	192	128	96	77
100	-	285	273	248	165	124	99
125	-	359	343	312	208	156	125
150	-	414	396	360	240	180	144
200	-	552	528	480	320	240	192
250	-	-	-	604	403	302	242
300	-	-	-	722	482	361	289

Note: 1 hp = 0.7457 kW.

Asynchronous-Motor Starting Parameters

The main parameters of direct on-line starting of three-phase asynchronous motors (90 % of all applications) are listed below.

- **I_r**: rated current
This is the current drawn by the motor at full rated load (e.g. approximately 100 A rms for 55 kW at 400 V).
- **I_d**: starting current
This is the current drawn by the motor during starting, on average 7.2 I_n for a duration t_d of 5 to 30 seconds depending on the application (e.g. 720 A rms for 10 seconds). These values determine the trip class and any additional "long-start" protection devices that may be needed.
- **I''_d**: peak starting current
This is the subtransient current during the first two half-waves when the system is energized, on the average 14 I_n for 10 to 15 ms (e.g. 1840 A peak).

The protection settings must effectively protect the motor, notably via a suitable thermal-relay trip class, but let the peak starting current through.

Standardized values in kW

Rated operational power kW	Standardized values in kW currents I _e (A) for:			
	230 V A	400 V A	500 V A	690 V A
0.06	0.35	0.32	0.16	0.12
0.09	0.52	0.3	0.24	0.17
0.12	0.7	0.44	0.32	0.23
0.18	1	0.6	0.48	0.35
0.25	1.5	0.85	0.68	0.49
0.37	1.9	1.1	0.88	0.64
0.55	2.6	1.5	1.2	0.87
0.75	3.3	1.9	1.5	1.1
1.1	4.7	2.7	2.2	1.6
1.5	6.3	3.6	2.9	2.1
2.2	8.5	4.9	3.9	2.8
3	11.3	6.5	5.2	3.8
4	15	8.5	6.8	4.9
5.5	20	11.5	9.2	6.7
7.5	27	15.5	12.4	8.9
11	38	22	17.6	12.8
15	51	29	23	17
18.5	61	35	28	21
22	72	41	33	24
30	96	55	44	32
37	115	66	53	39
45	140	80	64	47
55	169	97	78	57
75	230	132	106	77
90	278	160	128	93
110	340	195	156	113
132	400	230	184	134
160	487	280	224	162
200	609	350	280	203
250	748	430	344	250
315	940	540	432	313

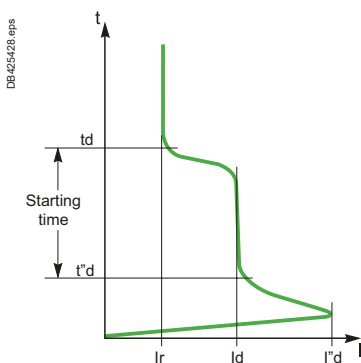

Typical motor-starting curve

ComPacT NSX Motor Protection Motor-Feeder Solutions

ComPacT NSX motor circuit breakers are designed for motor-feeder solutions using:

- Three devices, including an MA or 1.3 M magnetic-only trip unit
- Two devices including a 2 M or 6 E-M electronic trip units.

They are designed for use with contactors in the AC-3 utilization category (80 % of all cases) and they ensure type 2 coordination with the contactor.

For the AC-4 utilization category, the difficult conditions generally make it necessary to oversize the protection circuit breaker with respect to the AC-3 category.

ComPacT NSX Motor-Protection Range

ComPacT NSX trip units can be used to create motor-feeder solutions comprising two or three devices. The protection devices are designed for continuous duty at 65 °C.





Three-device solutions

- 1 NSX circuit breaker with an MA or MicroLogic 1.3 M trip unit
- 1 contactor
- 1 thermal relay

Two-device solutions

- 1 ComPacT NSX circuit breaker
 - With a MicroLogic 2.2 M or 2.3 M electronic trip unit
 - With a MicroLogic 6 E-M electronic trip unit. This version offers additional protection and power meter functions
- 1 contactor

B

Type of Motor Protection		3 Devices		2 Devices	
ComPacT NSX circuit breaker		NSX100/160/250	NSX400/630	NSX100 to 630	
Trip unit	Type 2 coordination with Type Technology	Contactor + thermal relay MA Magnetic 	MicroLogic 1.3 M Electronic 	Contactor MicroLogic 2 M Electronic 	MicroLogic 6 E-M Electronic 
Thermal relay	Separate	●	●		
	Built-in, class				
	5			●	●
	10			●	●
	20			●	●
	30				●
Protection functions of ComPacT NSX circuit breaker					
Short-circuits		●	●	●	●
Overloads				●	●
Insulation faults	Ground-fault				●
Special motor functions	Phase unbalance			●	●
	Locked rotor				●
	Under-load				●
	Long start				●
Built-in power meter functions					
I, U, energy					●
Operating assistance					
Counters (cycles, trips, alarms, hours)					●
Contact-wear indicator					●
Load profile and thermal image					●

> Discover our specific Motor Protection Offer:

TeSys GV



MKTED210011EN

ComPacT NSX Motor Protection MA Instantaneous Trip Units

MA magnetic trip units are used in 3 devices motor-feeder solutions. They can be mounted on all ComPacT NSX100/160/250 circuit breakers with performance levels B/F/H/N/S/L. They provide short-circuit protection for motors up to 110 kW at 400 V.

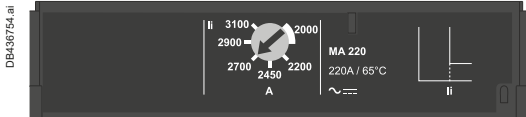

B

MA Magnetic Trip Units

In distribution applications, circuit breakers equipped with MA magnetic-only trip units are used for:

- Short-circuit protection of secondary windings of LV/LV transformers with overload protection on the primary side
- As an alternative to a switch-disconnector at the head of a switchboard in order to provide short-circuit protection.

Their main use is however for motor protection applications, in conjunction with a thermal relay and a contactor or motor starter.

Protection

Magnetic Protection (Ii)

Short-circuit protection with an adjustable pick-up Ii that initiates instantaneous tripping if exceeded.

- $I_i = I_n \times \dots$ set in amps on an adjustment dial  covering the range 6 to 14 x In for 2.5 to 100 A ratings or 9 to 14 In for 150 to 220 A ratings.

Protection Versions

- 3-pole (3P 3D): 3-pole frame (3P) with detection on all 3 poles (3D)
- 4-pole (4P 3D): 4-pole frame (4P) with detection on 3 poles (3D)

Magnetic Trip Units MA 2.5 to 220

Ratings (A)	In at 65 °C [1]	2.5	6.3	12.5	25	50	100 [1]	150	220
Circuit breaker	ComPacT NSX100	●	●	●	●	●	●	-	-
	ComPacT NSX160	-	-	-	●	●	●	●	-
	ComPacT NSX250	-	-	-	-	-	●	●	●
Instantaneous magnetic protection									
Pick-up (A) accuracy ±20 %	$I_i = I_n \times \dots$	Adjustable from 6 to 14 x In (settings 6, 7, 8, 9, 10, 11, 12, 13, 14)						Adjustable from 9 to 14 x In (settings 9, 10, 11, 12, 13, 14)	
Time delay (ms)	tm	fixed							

[1] MA100 3P adjustable from 6 to 14 x In.
MA100 4P adjustable from 9 to 14 x In.

Note: All the trip units have a transparent lead-sealable cover that avoids access to the adjustment dials.

ComPacT NSX Motor Protection MicroLogic 1.3 M Instantaneous Trip Units

MicroLogic 1.3 M trip units are used in 3 devices motor-feeder solutions on ComPacT NSX400/630 circuit breakers with performance levels B/F/H/N/S/L.

They provide short-circuit protection for motors up to 250 kW at 400 V.

They also provide the benefits of electronic technology:

- Accurate settings
- Tests
- "Ready" LED.

MicroLogic 1.3 M Trip Units

Circuit breakers with a MicroLogic 1.3 M trip unit are combined with a thermal relay and a contactor.

Protection

Settings are made using a dial.

Short-Circuits: Short-Time Protection (Isd)

Protection with an adjustable pick-up Isd. There is a very short delay to let through motor starting currents.

- Isd is set in amperes from 5 to 13 x In, as follows:
 - From 1600 to 4160 A for the 320 A rating
 - From 2500 to 6500 A for the 500 A rating

Short-Circuits: Non-Adjustable Instantaneous Protection (Ii)

Instantaneous protection with non-adjustable pick-up Ii.

Protection Version

- 3-pole (3P 3D): 3-pole frame (3P) equipped with detection on all 3 poles (3D).

Indications

Front indications

- Green "Ready" LED: flashes slowly when the circuit breaker is ready to trip in the event of a fault.

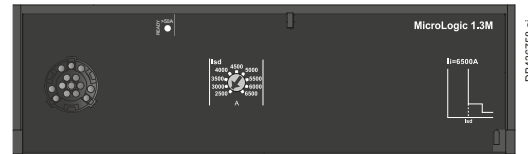

MicroLogic 1.3 M

	Ratings (A)	In at 65 °C [1]	320	500
Circuit breaker		ComPacT NSX400	●	-
		ComPacT NSX630	●	●
S Short-time protection				
Pick-up (A) accuracy ±15 %	Isd	Adjustable directly in amps		
		9 settings: 1600, 1920, 2440, 2560, 2880, 3200, 3520, 3840, 4160 A		9 settings: 2500, 3000, 3500, 4000, 4500, 5000, 5500, 6000, 6500 A
Time delay (ms)	tsd	Non-adjustable		
	Non-tripping time	10		
	Maximum break time	60		
I Instantaneous protection				
Pick-up (A) accuracy ±15 %	Ii non-adjustable	4800	6500	
	Non-tripping time	0		
	Maximum break time	30 ms		

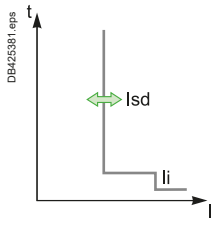

[1] Motor standards require operation at 65 °C. Circuit-breaker ratings are derated to take this requirement into account (see pages E-14 to E-17).

ComPacT NSX Motor Protection

MicroLogic 2.2/2.3 M Electronic Trip Units

MicroLogic 2.2/2.3 M trip units provide built-in thermal and magnetic protection. They are used in 2 devices motor-feeder solutions on ComPacT NSX100 to 630 circuit breakers with performance levels B/F/H/N/S/L. They provide protection for motors up to 315 kW at 400 V against:

- Short-circuits
- Overloads with selection of a trip class (5, 10 or 20)
- Phase unbalance.

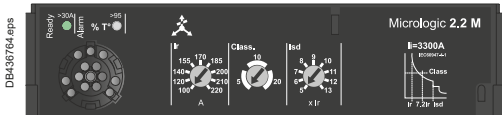

DB436764.eps

B

Circuit breakers with a MicroLogic 2.2/2.3 M trip unit include protection similar to an inverse-time thermal relay. They are combined with a contactor.

Protection

Settings are made using a dial.

L Overloads (or thermal protection): Long-time protection and trip class (I_r)
Inverse-time thermal protection against overloads with adjustable pick-up I_r. Settings are made in amperes. The tripping curve for the long-time protection, which indicates the time delay **t_r** before tripping, is defined by the selected trip class.

Trip class (class)

The class is selected as a function of the normal motor starting time.

- Class 5: starting time less than 5 s.
- Class 10: starting time less than 10 s.
- Class 20: starting time less than 20 s.

For a given class, it is necessary to check that all motor-feeder components are sized to carry the 7.2 I_r starting current without excessive temperature rise during the time corresponding to the class.

S Short-circuits: Short-time protection (I_{sd})

Protection with an adjustable pick-up I_{sd}. There is a very short delay to let through motor starting currents.

I Short-circuits: Non-adjustable instantaneous protection (I_i)

Instantaneous protection with non-adjustable pick-up I_i.

Phase unbalance or phase loss (I_{unbal}) (⚡)

This function opens the circuit breaker if a phase unbalance occurs:

- That is greater than the 30 % fixed pick-up **I_{unbal}**
- Following the non-adjustable time delay **t_{unbal}** equal to:
 - 0.7 s during starting
 - 4 s during normal operation.

Phase loss is an extreme case of phase unbalance and leads to tripping under the same conditions.

Indications

Front indications

- Green "Ready" LED: flashes slowly when the circuit breaker is ready to trip in the event of a fault.
- Red alarm LED for motor operation: goes ON when the thermal image of the rotor and stator is greater than 95 % of the permissible temperature rise.

Remote indications via SDTAM module

ComPacT NSX devices with a MicroLogic 2 can be equipped with an SDTAM module dedicated to motor applications for:

- A contact to indicate circuit-breaker overload
- A contact to open the contactor. In the event of a phase unbalance or overload, this output is activated 400 ms before circuit-breaker tripping to open the contactor and avoid circuit breaker tripping.

This module takes the place of the MN/MX coils and an OF contact.

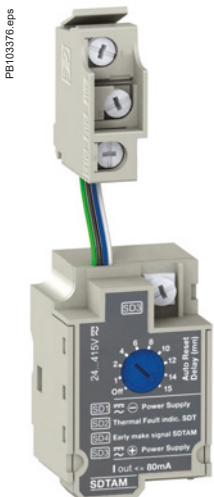

PB103376.eps

SDTAM remote indication relay module with its terminal block

Note: All the trip units have a transparent lead-sealable cover that avoids access to the adjustment dials.

ComPacT NSX Motor Protection MicroLogic 2.2/2.3 M Electronic Trip Units

MicroLogic 2.2/2.3 M

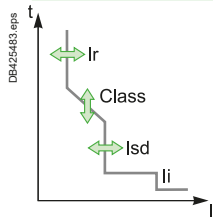

Ratings (A)	In at 65 °C [1]	25	50	100	150	220	320	500
Circuit breaker	ComPacT NSX100	●	●	●	-	-	-	-
	ComPacT NSX160	●	●	●	●	-	-	-
	ComPacT NSX250	●	●	●	●	●	-	-
	ComPacT NSX400	-	-	-	-	-	●	-
	ComPacT NSX630	-	-	-	-	-	●	●

L Overloads (or thermal protection): Long-time protection and trip class

Pick-up (A) tripping between 1.05 and 1.20 Ir	Ir	Value depending on trip unit rating (In) and setting on dial								
In = 25 A	Ir =	12	14	16	18	20	22	23	24	25
In = 50 A	Ir =	25	30	32	36	40	42	45	47	50
In = 100 A	Ir =	50	60	70	75	80	85	90	95	100
In = 150 A	Ir =	70	80	90	100	110	120	130	140	150
In = 220 A	Ir =	100	120	140	155	170	185	200	210	220
In = 320 A	Ir =	160	180	200	220	240	260	280	300	320
In = 500 A	Ir =	250	280	320	350	380	400	440	470	500
Trip class as per IEC 60947-4-1		5	10	20						

Time delay (s) depending on selected trip class	tr	1.5 x Ir	240	480	for warm motor					
		6 x Ir	6.5	13.5	26	for cold motor				
		7.2 x Ir	5	10	20	for cold motor				

Thermal memory: 20 minutes before and after tripping
Cooling fan: Non-adjustable - motor self-cooled

S₀ Short-circuits: Short-time protection with fixed time delay

Pick-up (A) accuracy ±15 %	Isd = Ir x ...	5	6	7	8	9	10	11	12	13
Time delay (ms)	tsd	Non-adjustable								
	Non-tripping time	10								
	Maximum break time	60								

I Short-circuits: Non-adjustable instantaneous protection

Pick-up (A) accuracy ±15 %	Ii non-adjustable	425	750	1500	2250	3300	4800	6500	
Time delay (ms)	Non-tripping time	0							
	Maximum break time	30							

Phase unbalance or phase loss

Pick-up (A) accuracy ±20 %	Iunbal in % average current [2]	> 30 %
Time delay (s)	Non-adjustable	0.7 s during starting 4 s during normal operation

[1] Motor standards require operation at 65 °C. Circuit-breaker ratings are derated to take this requirement into account (see pages E-14 to E-17).
[2] The unbalance measurement takes into account the most unbalanced phase with respect to the average current.



ComPacT NSX Motor Protection

MicroLogic 6 E-M Electronic Trip Units

MicroLogic 6.E-M is used in 2 devices motor-feeder solutions. It provides the same protection as MicroLogic 2 M:

- Short-circuits
- Overloads with selection of the same trip classes (5, 10 or 20), plus trip class 30 for starting of machines with high inertia.

In addition, it offers specific motor-protection functions that can be set via the keypad.



B

Protection

The protection can be fine-adjusted via the keypad . Access to setting modifications via the keypad is protected by a locking function that is controlled by a microswitch . The lock is activated automatically if the keypad is not used for 5 minutes. Access to the microswitch is protected by a transparent lead-sealable cover. It is possible to scroll through settings and measurements with the cover closed.

Overloads (or thermal), class and short-circuits

The long-time, short-time and instantaneous functions are identical to those of MicroLogic 2 M.

In addition, there is trip class 30 for long-time protection and a setting for self-cooled or fan-cooled motors ().

Ground-fault protection (lg)

Residual type ground-fault protection with an adjustable pick-up **lg** (with Off position) and adjustable time delay **tg**.

Phase unbalance or phase loss

This function opens the circuit breaker if a phase unbalance occurs:

- That is greater than the **I-unbal** pick-up that can be fine-adjusted from 10 to 40 % (30 % by default)
- Following the **tunbal** time delay that is:
 - 0.7 s during starting
 - Adjustable from 1 to 10 seconds (4 seconds by default) during normal operation.

Phase loss is an extreme case of phase unbalance and leads to tripping under the same conditions.

Locked rotor (I-jam)

This function detects locking of the motor shaft caused by the load.

During motor starting (see page B-37), the function is disabled.

During normal operation, it causes tripping:

- Above the **I-jam** pick-up that can be fine-adjusted from 1 to 8 x Ir
- In conjunction with the **tjam** time delay that can be adjusted from 1 to 30 seconds

Under-load (I-und)

This function detects motor no-load operation due to insufficient load (e.g. a drained pump). It detects phase undercurrent.

During motor starting (see page B-37), the function is always enabled.

During normal operation, it causes tripping:

- Below the **I-und** pick-up that can be fine-adjusted from 0.3 to 0.9 x Ir
- In conjunction with the **tund** time delay that can be adjusted from 1 to 200 seconds.

Long starts (I-long)

This protection supplements thermal protection (class).

It is used to better adjust protection to the starting parameters.

It detects abnormal motor starting, i.e. when the starting current remains too high or too low with respect to a pick-up value and a time delay.

It causes tripping:

- In relation with a **llong** pick-up that can be fine-adjusted from 1 to 8 x Ir
- In conjunction with the **tlong** time delay that can be adjusted from 1 to 200 seconds (see "long starts" page B-37).

Note: All the trip units have a transparent lead-sealable cover that avoids access to the adjustment dials.

ComPacT NSX Motor Protection MicroLogic 6 E-M Electronic Trip Units

Display of Type of Fault

On a fault trip, the type of fault (Ir, Isd, li, Ig, lunbal, ljam), the phase concerned and the interrupted current are displayed.

Indications

Front indications

- Green "Ready" LED: flashes slowly when the circuit breaker is ready to trip in the event of a fault.
- Red alarm LED for motor operation: goes ON when the thermal image of the rotor or stator is greater than 95% of the permissible temperature rise.

Remote indications via SDTAM or SDx module

See description on [page C-31](#) for SDTAM and for SDx.

B

MicroLogic 6.2/6.3 E-M

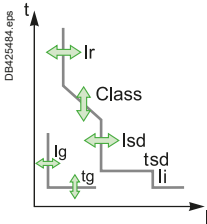

Ratings (A)	In at 65 °C [1]	25	50	80	150	220	320	500
Circuit breaker	ComPacT NSX100	●	●	●	-	-	-	-
	ComPacT NSX160	●	●	●	●	-	-	-
	ComPacT NSX250	●	●	●	●	●	-	-
	ComPacT NSX400	-	-	-	-	-	●	-
	ComPacT NSX630	-	-	-	-	-	●	●

L Overloads: Long-time protection

Pick-up (A)	Ir	Dial setting	Value depending on trip-unit rating (In) and setting on dial									
Tripping between 1.05 and 1.20 Ir		In = 25 A Ir =	12	14	16	18	20	22	23	24	25	
		In = 50 A Ir =	25	30	32	36	40	42	45	47	50	
		In = 80 A Ir =	35	42	47	52	57	60	65	72	80	
		In = 150 A Ir =	70	80	90	100	110	120	130	140	150	
		In = 220 A Ir =	100	120	140	155	170	185	200	210	220	
		In = 320 A Ir =	160	180	200	220	240	260	280	300	320	
		In = 500 A Ir =	250	280	320	350	380	400	440	470	500	
		Keypad setting	Fine adjustments in 1 A steps below maximum value defined by dial setting									
Trip class as per IEC 60947-4-1			5	10	20	30						
Time delay (s) depending on selected trip class	tr	1.5 x Ir	120	240	480	720	for warm motor					
		6 x Ir	6.5	13.5	26	38	for cold motor					
		7.2 x Ir	5	10	20	30	for cold motor					
Thermal memory			20 minutes before and after tripping									
Cooling fan			Settings for self-cooled or fan-cooled motors									

S_n Short-circuits: Short-time protection with fixed time delay

Pick-up (A) accuracy ±15 %	Isd = Ir x ...	5	6	7	8	9	10	11	12	13	
Time delay	tsd	Non-adjustable									
	Non-tripping time	10 ms									
	Maximum break time	60 ms									

I Short-circuits: Non-adjustable instantaneous protection

Pick-up (A) accuracy ±15 %	li non-adjustable	425	750	1200	2250	3300	4800	6500	
	Non-tripping time	0 ms							
	Maximum break time	30 ms							

G Ground faults

Pick-up (A) accuracy ±10 %	Ig = In x ...	Dial setting										
	In = 25 A Ig =	0.6	0.6	0.6	0.6	0.7	0.8	0.9	1	Off		
	In = 50 A Ig =	0.3	0.4	0.5	0.6	0.7	0.8	0.9	1	Off		
	In > 50 A Ig =	0.2	0.3	0.4	0.5	0.6	0.7	0.8	1	Off		
		Fine adjustments in 0.05 x In steps										
Time delay (ms)	tg	0	0.1	0.2	0.3	0.4						
	Non-tripping time	20	80	140	230	350						
	Maximum break time	80	140	200	320	500						

[1] Motor standards require operation at 65 °C. Circuit-breaker ratings are derated to take this requirement into account (see pages E-14 to E-17).

[2] The unbalance measurement takes into account the most unbalanced phase with respect to the average current.

ComPacT NSX Motor Protection

MicroLogic 6 E-M Electronic Trip Units

MicroLogic 6.2 E M/6.3 E M

Phase unbalance or phase loss

Pick-up (A) accuracy $\pm 20\%$	lunbal = in % average current ^[2]	adjustable from 10 to 40 %, default setting = 30 % fine adjustments in 1 % steps using the keypad activated during motor starting
Time delay (s)	tunbal	0.7 s during starting 1 to 10 seconds during normal operation, default setting = 4 seconds fine adjustments in 1 s steps using the keypad

Locked rotor

Pick-up (A) accuracy $\pm 10\%$	ljam = $I_r \times \dots$	1 x 8 I_r with Off position, default setting = Off fine adjustments in 0.1 x I_r steps using the keypad disabled during motor starting
Time delay (s)	tjam =	1 to 30 seconds fine adjustments in 1 s steps using the keypad, default setting = 5 s

Under-load (under-current)

Pick-up (A) accuracy $\pm 10\%$	lund = $I_r \times \dots$	0.3 x 0.9 I_r with Off position, default setting = Off Fine adjustments in $I_r \times 0.01$ steps using the EcoStruxure Power Commission software activated during motor starting
Time delay (s)	tund =	1 to 200 seconds fine adjustments in 1 s steps using the EcoStruxure Power Commission software, default setting = 10 s

Long starts

Pick-up (A) accuracy $\pm 10\%$	llong = $I_r \times \dots$	1 x 8 I_r with Off position, default setting = Off Fine adjustments in $I_r \times 0.1$ steps using the EcoStruxure Power Commission software activated during motor starting
Time delay (s)	tlong =	1 to 200 seconds fine adjustments in 1 s steps using the EcoStruxure Power Commission software, default setting = 10 s

[1] Motor standards require operation at 65 °C. Circuit-breaker ratings are derated to take this requirement into account (see pages E-14 to E-17).

[2] The unbalance measurement takes into account the most unbalanced phase with respect to the average current.

B

ComPacT NSX Motor Protection

Additional Technical Characteristics

Phase unbalance

An unbalance in three-phase systems occurs when the three voltages are not equal in amplitude and/or not displaced 120° with respect to each other. It is generally due to single-phase loads that are incorrectly distributed throughout the system and unbalance the voltages between the phases.

These unbalances create negative current components that cause braking torques and temperature rise in asynchronous machines, thus leading to premature ageing.

Phase loss

Phase loss is a special case of phase unbalance.

- During normal operation, it produces the effects mentioned above and tripping must occur after four seconds.
- During starting, the absence of a phase may cause motor reversing, i.e. it is the load that determines the direction of rotation. This requires virtually immediate tripping (0.7 seconds).

Starting time in compliance with the class (MicroLogic 2 M)

For normal motor starting, MicroLogic 2 M checks the conditions below with respect to the thermal-protection (long-time) pick-up I_r :

- Current > 10 % x I_r (motor-off limit)
- Overrun of 1.5 x I_r threshold, then return below this threshold before the end of a 10 s time delay.

If either of these conditions is not met, the thermal protection trips the device after a maximum time equal to that of the selected class.

Pick-up I_r must have been set to the current indicated on the motor rating plate.

Long starts (MicroLogic 6 E-M)

When this function is not activated, the starting conditions are those indicated above. When it is activated, this protection supplements thermal protection (class).

A long start causes tripping and is characterized by:

- Current > 10 % x I_r (motor-off limit) with:
 - Either overrun of the long-time pick-up (1 to 8 x I_r) without return below the pick-up before the end of the long-time time delay (1 to 200 s)
 - Or no overrun of the long-time pick-up (1 to 8 x I_r) before the end of the long-time time delay (1 to 200 s).

Pick-up I_r must have been set to the current indicated on the motor rating plate.

This protection should be coordinated with the selected class.

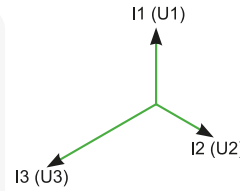

Unbalance of phase currents and voltages

DB425420.eps

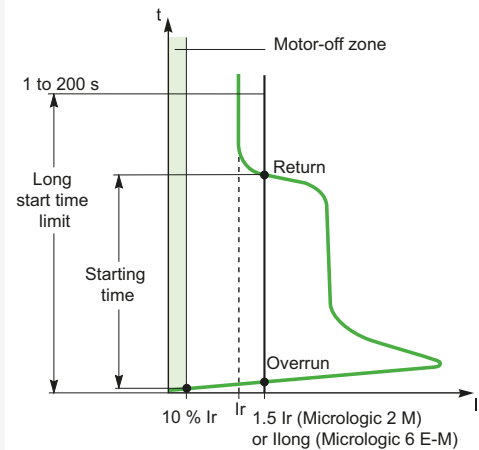

Motor starting and long starts

DB425430.eps



ComPacT NSX Measurement

MicroLogic 5/6/7 E Electronic Trip Units

ComPacT NSX with its embedded current sensors handled by a microprocessor that operates independently of protection functions and MicroLogic 5/6/7 E is a PMD-DD Power Meter Device complying with IEC/EN 61557-12, Class 0.5 for voltage, Class 1 for current and Class 2 for active power and energy measurements.

B

Measures and Electrical Parameters Calculated by the MicroLogic 5/6/7 E Trip Units

Based on the measure of line currents, neutral current, phase to phase voltages and phase to neutral voltages, the MicroLogic 5/6/7 E trip units calculate and display all the parameters required to monitor any AC electrical power supply including power quality, power management and energy efficiency:

- RMS values of currents and voltages
- Active, reactive and apparent powers, active, reactive and apparent energies
- Power factor
- Frequency
- Unbalance on voltage and THD of voltages and currents
- Demand and maximum demand values

The maximum and minimum values are stored in the MicroLogic 5/6/7 E trip units non volatile memory. They are resettable from the embedded display, FDM display or a PC running EcoStruxure Power Commission software.

Demand and Maximum Demand Values

MicroLogic E also calculates demand current and power values. These calculations can be made using a block or sliding interval that can be set from 5 to 60 minutes in steps of 1 minute. The window can be synchronized with a signal sent via the communication system. Whatever the calculation method, the calculated values can be recovered on a PC via Modbus communication.

Ordinary spreadsheet software can be used to provide trend curves and forecasts based on this data. They will provide a basis for load shedding and reconnection operations used to adjust consumption to the subscribed power.

Electrical values can be displayed on the embedded HMI, a PC running EcoStruxure Power Commission software and on the FDM display unit.

They are refreshed every second.

The display on the embedded HMI is accessed by means of a contextual menu allowing to navigate easily through the electrical values. Alternatively a Quickview option allows to display the main basic values.

Optional external 24 Vdc supply module is required to process and display the measurements including energy counters for currents below 20 % of the rated current.

The phase to neutral voltages are available for 4 poles circuit breakers and 3 poles circuit breakers as well providing the connection of the MicroLogic 5/6 E to the neutral (ENVT). This connection is mandatory for an accurate active power measurement.

Neutral-Phase measurement is only possible on the 4-pole MicroLogic Vigi 7 E (not on the 3-pole).

No External Neutral connection on the MicroLogic Vigi 7 E.

Please refer to the user manual for more details concerning the wiring and the configuration of MicroLogic 5/6/7 E.

ComPacT NSX Measurement MicroLogic 5/6/7 E Electronic Trip Units

B

MicroLogic 5/6/7 E for Energy Management Functions

Active Power and Energy metering in ComPacT NSX with MicroLogic 5/6/7 E has been designed and tested to provide accuracy: **Class 2 according to IEC/EN 61557-12**. This standard specifies requirements for combined performance of measuring and monitoring devices that measure and monitor the electrical parameters within electrical distribution systems. It covers both devices with external sensors such as current and/or voltage transformers like stand alone power meter (PMD-S) and devices with embedded sensors (PMD-D) like circuit breakers.

In addition a list of available performance class for all relevant measurement functions is specified in IEC/EN 61557-12, in opposition to most other standards such as IEC 62053-2x series that are dealing only with active and reactive energy.

ComPacT NSX equipped with MicroLogic 5/6/7 E and its own embedded sensors is a Class 2 full chain measurement PMD-D device for active power and energy metering according to IEC/EN 61557-12.

PMD-D offer the benefit of avoiding uncertainty and variation due to external sensors and wiring.

IEC/EN 61557-12 standard defines three levels of uncertainty (intrinsic uncertainty, operating uncertainty, overall system uncertainty) that need to be checked to ensure accuracy class.

The uncertainty is the estimated amount or percentage by which a measured value may differ from the true value. According to IEC/EN 61557-12, the total uncertainty of a measurement, in general, depends on the instrument, the environment, and other elements to be considered.

Note: Requirements for Class 2 active power and energy in IEC/EN 61557-12 regarding limits of uncertainty due to variation of the current for different power factor, and limits of uncertainty due to influence quantities such as temperature are equivalent to IEC 62053-2x standards.

PMD-D - Embedded Sensors

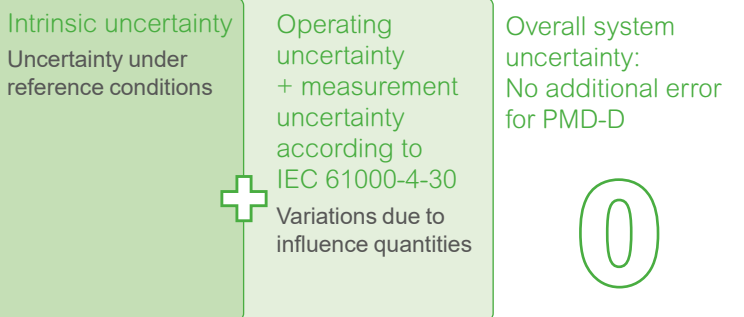

PMD-S - External Sensors

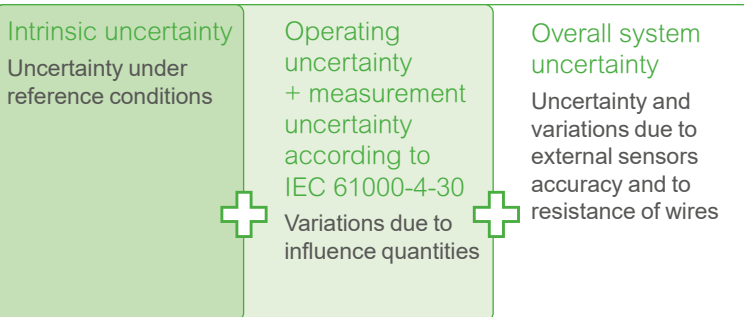

PMD-D - Embedded sensors

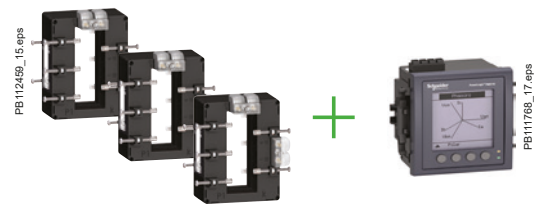

PMD-S - External sensors

ComPacT NSX Measurement

MicroLogic 5/6/7 E Electronic Trip Units



Compliance with ISO 50001: Reliability and Repeatability Over Time of Energy Measurement

Scope and main requirements of ISO 50001:

ISO 50001 specifies requirements for systems and organization dedicated to energy management. This international standard defines rules and gives recommendations to achieve continual improvement of energy performance, including energy efficiency, energy use and consumption, measurements, documentation and reporting. Energy performance shall be monitored and significant deviations shall be investigated. It implies that the accuracy of the instruments used for this purpose remains stable throughout their entire operating life which ensures the repeatability of the measurements (ISO 50001, clause 4.6 and 4.6.1 Checking, monitoring, measurement and analysis).

In ComPacT NSX with MicroLogic 5/6/7 E, the metering and protection functions are designed to perform accurate and repeatable measurements during MicroLogic E life time, provided it's used in the specified environmental conditions as defined in ComPacT NSX User Guide. Current sensors and MicroLogic E are calibrated during circuit breaker manufacturing and are not supposed to be re-calibrated during this life time. In general, electronic instrument measuring electric parameters don't request any specific maintenance provided they are working within environmental specifications. Accuracy can be reduced in case of operation under exceptional conditions, lightning strikes, high temperature, high degree of humidity, this is why a periodic verification is recommended (please refer to the annex I of the AFNOR Document FD X30-147: Metrological maintenance recommendations, applicable to electrical and fluidic measurements).

IEC 60364-8-1 Clause 8.3.1.1 Requirement on Accuracy and Measuring Range

Scope and main requirements of IEC 60364-8-1:

IEC 60364-8-1 provides requirements and recommendations for the design, erection and verification of low voltage electrical installations including local production and storage of energy for optimizing the overall efficient use of electricity. It introduces recommendations for the design of an electrical installation within the framework of an energy efficiency management approach in order to get low electrical energy consumption and acceptable energy availability. It also specifies the accuracies of the measuring instruments involved in the functions of energy management such as:

- Energy usage analysis and optimization
- Contract optimization
- Cost allocation
- Efficiency assessment
- Energy usage trends assessment.

ComPacT NSX with MicroLogic 5/6/7 E complies with the requirements of IEC 60364-8-1 dedicated to the optimization of energy efficiency. It provides a range of measurements with accuracies required for complex energy efficiency approaches.

The table below from IEC 60364-8-1:2014 Clause 8.3.1.1 "Requirement on accuracy and measuring range" specifies the accuracies required for the measurements dedicated to cost management

	Incomer	ComPacT NSX main applications		Final distribution board
		Main LV switchboard	Intermediate distribution boards	
Measurement objectives for cost management	<ul style="list-style-type: none"> ■ Revenue metering ■ Bill checking ■ Energy usage analysis and optimization ■ Contract optimization ■ Regulatory compliance 	<ul style="list-style-type: none"> ■ Cost allocation ■ Energy usage analysis and optimization ■ Efficiency assessment ■ Contract optimization ■ Regulatory compliance 	<ul style="list-style-type: none"> ■ Cost allocation ■ Energy usage analysis and optimization ■ Efficiency assessment ■ Contract optimization ■ Regulatory compliance 	<ul style="list-style-type: none"> ■ Energy usage analysis and optimization ■ Energy usage trends assessment
Overall system accuracy of active energy measurement	In general, excellent accuracy, e.g. class 0.2 to class 1	In general, good accuracy, e.g. class 0.5 to class 2	In general, medium accuracy, e.g. class 1 to class 3	In general, reliable indication should be more important than accuracy

ComPacT NSX Measurement MicroLogic 5/6/7 E Electronic Trip Units



MicroLogic 5/6/7 Integrated Power Meter Functions			Type	Display	
			E	MicroLogic LCD	FDM display
Display of protection settings					
Pick-ups (A) and delays	Settings MicroLogic 5/6	I _r , tr, I _{sd} , t _{sd} , I _i , I _g , t _g	●	●	-
	Settings MicroLogic Vigi 7 E [4]	I _r , tr, I _{sd} , t _{sd} , I _i , I _{Δn} , Δt, I _{Δn} % pre-alarm	●	●	
Measurements					
Instantaneous rms measurements					
Currents (A)	Phases and neutral	I1, I2, I3, IN	●	●	●
	Average of phases	I _{avg} = (I1 + I2 + I3)/3	●	-	●
	Highest current of the 3 phases and neutral	I _{max} of I1, I2, I3, IN	●	●	●
	Ground fault (MicroLogic 6)	% I _g (pick-up setting)	●	●	●
	Earth leakage (MicroLogic Vigi 7 E)	% I _{Δn} (pick-up setting)	●		
	Highest Earth Leakage current	I _{Δn} max	●	-	-
	Current unbalance between phases	% I _{avg}	●	-	●
Voltages (V)	Phase-to-phase	U12, U23, U31	●	●	●
	Phase-to-neutral	V1N, V2N, V3N	●	●	●
	Average of phase-to-phase voltages	U _{avg} = (U12 + U21 + U23)/3	●	-	●
	Average of phase-to-neutral voltages	V _{avg} = (V1N + V2N + V3N)/3	●	-	●
	Ph-Ph and Ph-N voltage unbalance	% U _{avg} and % V _{avg}	●	-	●
	Phase sequence	1-2-3, 1-3-2	●	●	● [3]
Frequency (Hz)	Power system	f	●	-	●
Power	Active (kW)	P, total/per phase	●/●	●/-	●/●
	Reactive (kVAR)	Q, total/per phase	●/●	●/-	●/●
	Apparent (kVA)	S, total/per phase	●/●	●/-	●/●
	Power factor and cos φ (fundamental)	PF and cos φ, total and per phase	●	-	●
Maximeters/minimeters					
	Associated with instantaneous rms measurements	Reset via MicroLogic or FDM display unit	●	-	●
Energy metering					
Energy	Active (kWh), reactive (kvarh), apparent (kVAh)	Total since last reset Absolute or signed mode [1]	●	●	●
Demand and maximum demand values					
Demand current (A)	Phases and neutral	Present value on the selected window	●	-	●
		Maximum demand since last reset	●	-	●
Demand power	Active (kWh), reactive (kvarh), apparent (kVA)	Present value on the selected window	●	-	●
		Maximum demand since last reset	●	-	●
Calculation window	Sliding, fixed or com-synchronized	Adjustable from 5 to 60 minutes in 1 minute steps [2]	●	-	-
Power quality					
Total harmonic distortion (%)	Of voltage with respect to rms value	THDU, THDV of the Ph-Ph and Ph-N voltage	●	-	●
	Of current with respect to rms value	THDI of the phase current	●	-	●

[1] Absolute mode: E absolute = E out + E in; Signed mode: E signed = E out - E in.

[2] Available via the communication system only.

[3] FDM121 only.

[4] Two last I_{Δn} and Δt values are available as well as date of setting.

Additional technical characteristics

- Measurement accuracy
 Accuracies are those of the entire measurement system, including the sensors:
- Current: Class 1 as per IEC 61557-12
 - Voltage: 0.5 %
 - Power and energy: Class 2 as per IEC 61557-12
 - Frequency: 0.1 %.



ComPacT NSX Diagnostics & Maintenance

MicroLogic 5/6/7 E Electronic Trip Units

B



MicroLogic built-in LCD display

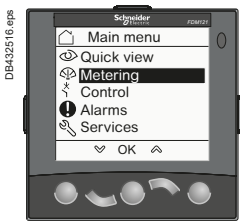

FDM121 display: navigation

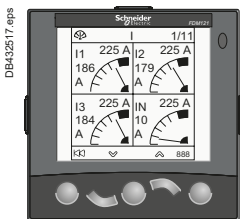

FDM121 display: current

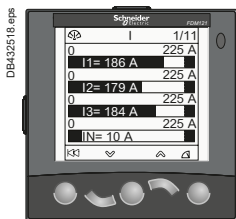

FDM121 display: voltage

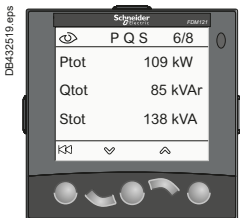

FDM121 display: power

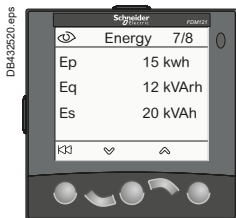

FDM121 display: consumption

Examples of operating-assistance screens on the FDM121 display unit

Personalized Alarms with Time-Stamping

Alarm types

The user can assign an alarm to all MicroLogic E measurements or events:

- Up to 12 alarms can be used together:
 - Two alarms are predefined and activated automatically:
 - MicroLogic 5: overload (Ir)
 - MicroLogic 6: overload (Ir) and ground fault (Ig)
 - MicroLogic Vigi 7 E: overload (Ir) and earth leakage fault (IΔn)
 - Thresholds, priorities and time delays can be set for ten other alarms.
- The same measurement can be used for different alarms to precisely monitor certain values, e.g. the frequency or the voltage
- Alarms can also be assigned to various states: phase lead/lag, four quadrants, phase sequence
- Selection of display priorities, with pop-up possibility
- Alarm time-stamping.

Alarm settings

Alarms cannot be set via the keypad or the FDM display unit. They are set via communication with the PC. Set-up includes the threshold, priority, activation delay before display and deactivation delay. It is also possible to reprogram the standard assignment for the two SDx relay outputs to user-selected alarms.

Alarm reading

Remote alarm indications.

- Reading on FDM display unit or on PC via the communication system.
- Remote indications via SDx relay with two output contacts for alarms.

Histories and Event Tables

MicroLogic E has histories and event tables that are always active.

Three types of time-stamped histories

- Tripping due to overruns of Ir, I_{sd}, I_l, Ig, IΔn: last 17 trips
- Alarms: last 10 alarms
- Operating events: last 10 events

Each history record is stored with:

- Indications in clear text in a number of user-selectable languages
- Time-stamping: date and time of event
- Status: pick-up/drop-out

Two types of time-stamped event tables

- Protection settings
- Minimizers/maximizers

Display of alarms and tables

The time-stamped histories and event tables may be displayed on a PC via the communication system.

Embedded memory

MicroLogic E has a non-volatile memory that registers all data on alarms, histories, event tables, counters and maintenance indicators even if power is lost.

Maintenance Indicators

MicroLogic E has indicators for, among others, the number of operating cycles, contact wear and operating times (operating hours counter) of the ComPacT NSX circuit breaker.

It is possible to assign an alarm to the operating cycle counter to plan maintenance. The various indicators can be used together with the trip histories to analyse the level of stresses the device has been subjected to.

The information provided by the indicators cannot be displayed on the MicroLogic LCD. It is displayed on the PC via the communication system.

Management of Installed Devices

Each circuit breaker equipped with a MicroLogic 5 or 6 or 7 trip unit can be identified via the communication system:

- Serial number
- Firmware version
- Hardware version
- Device name assigned by the user.

This information together with the previously described indications provides a clear view of the installed devices.

ComPacT NSX Diagnostics & Maintenance

MicroLogic 5/6/7 E Electronic Trip Units



MicroLogic 5/6/7 Operating Assistance Functions			Type	Display	
			E	MicroLogic LCD	FDM display
Operating assistance					
Personalized alarms					
Settings	Up to 10 alarms assigned to all A and E measurements ^[2]		⊙	-	-
	Phase lead/lag, four quadrants, phase sequence, display priority selection ^[2]		⊙	-	-
Display	Alarms/tripping/test (Earth Leakage)		⊙	⊙/⊙/⊙	⊙/⊙/⊙
Remote indications	Activation of two dedicated contacts on SDx module		⊙	-	-
Time-stamped histories (ms)					
Trips (last 17)	Cause of tripping	I _r , I _s d, I _i (MicroLogic 5, 6)	⊙	-	⊙
		I _g (MicroLogic 6)	⊙	-	⊙
		I _r , I _s d, I _i , I _Δ n (MicroLogic Vigi 7 E)	⊙	-	⊙
		Phase fault	⊙	-	⊙
		Interrupted current value	⊙	-	⊙
Alarms (last 10)			⊙	-	⊙
Test Earth Leakage (last 10)	MicroLogic Vigi 7 E		⊙	-	⊙
Operating events (last 10)	Event types	Modification of protection setting by dial	⊙	-	⊙
		Opening of keypad lock	⊙	-	⊙
		Test via keypad	⊙	-	⊙
		Test via external tool	⊙	-	⊙
		Time setting (date and time)	⊙	-	⊙
		Reset for maximeter/minimeter and energy meter	⊙	-	⊙
Time stamping (date and time, text, status)			⊙	-	⊙
Time-stamped event tables					
Protection settings	Setting modified (value displayed)	I _r , tr, I _s d, t _s d, I _i , I _g , t _g ^[2]	⊙	-	-
		I _r , tr, I _s d, t _s d, I _i , I _Δ n, Δt (MicroLogic Vigi 7 E) ^[2]	⊙	-	⊙
		Time-stamping	⊙	-	-
		Previous value	⊙	-	-
Min/Max	Values monitored	I ₁ , I ₂ , I ₃ , I _N	⊙	-	⊙
		U ₁₂ , U ₂₃ , U ₃₁ , f	⊙	-	⊙
		Time-stamping of each value	⊙	-	⊙
		Current min/max value	⊙	-	⊙
Maintenance indicators					
Counter		Mechanical cycles ^[1]	⊙	-	⊙
		Electrical cycles ^[1]	⊙	-	⊙
		Trips	⊙	-	-
		Alarms	⊙	-	-
		Hours	⊙	-	-
Indicator	Contact wear	%	⊙	-	⊙
Load profile	Hours at different load levels	% of hours in four current ranges: 0-49 % I _n , 50-79 % I _n , 80-89 % I _n and ≥ 90 % I _n	⊙	-	⊙

[1] The BSCM module is required for these functions.

[2] Available via the communication system only.

Additional technical characteristics

Contact wear

Each time ComPacT NSX opens, the MicroLogic 5/6/7 trip unit measures the interrupted current and increments the contact-wear indicator as a function of the interrupted current, according to test results stored in memory. Breaking under normal load conditions results in a very slight increment. The indicator value may be read on the FDM121 display. It provides an estimation of contact wear calculated on the basis of the cumulative forces affecting the circuit breaker. When the indicator reaches 80 %, it is advised to replace the circuit breaker to ensure the availability of the protected equipment.

Circuit breaker load profile

MicroLogic 5/6/7 calculates the load profile of the circuit breaker protecting a load circuit. The profile indicates the percentage of the total operating time at four current levels (% of breaker I_n):

- 0 to 49 % I_n
- 50 to 79 % I_n
- 80 to 89 % I_n
- ≥ 90 % I_n. This information can be used to optimize use of the protected equipment or to plan ahead for extensions.



ComPacT NSX Diagnostics & Maintenance

MicroLogic 5/6/7 E Electronic Trip Units

Electrical power supply availability and reliability are the main critical issues affecting profitability and competitiveness. Outage management focuses on preventing, detecting, locating and clearing faults.

B



C2E5SCZ50.eps

MicroLogic built-in LCD display

The MicroLogic 5/6/7 E control units perform in real time a high level of diagnostics on ComPacT NSX circuit breakers. They generate and store appropriate warnings, alarms and messages to help the users with maintenance and power restoration. This function complies with the following end user values:

- Prevent interruption of the power supply, to ensure continuity of operation, to preserve the asset from any damage and to support people safety.
- Reduce downtime resulting from an unexpected failure in the electrical distribution system, to be able to restart as quickly as possible after a trip.
- To keep the devices in good condition of operation.

Prevention of Power Supply Interruptions

Prevention of power supply interruptions is achieved by generation of warnings to the users, preventive operations of maintenance, and anticipation of device replacement.

By means of dedicated features, MicroLogic 5/6/7 E monitors the health of the circuit breaker and generates appropriate information to help the users in scheduling periodic checks and, if needed, anticipated replacement of devices.

ComPacT NSX Special Applications

Protection of Public Distribution Systems with MicroLogic 2-AB

MicroLogic AB trip units are used in public distribution systems to limit the current supplied according to the consumer's contract. They are available in 100, 160, 240 and 400 A ratings and are supplied with a lead-seal device to protect the settings.

ComPacT NSX circuit breakers equipped with MicroLogic AB trip units are installed as incoming devices for consumer installations connected to the public LV distribution system.

With respect to the utility, they have two functions.

- Consumption is limited to the contractual power level. If the limit is exceeded, a fast thermal-protection function trips the device at the head of the consumer's installation without the utility having to intervene.
- Total selectivity is ensured with the upstream fuses on the public distribution system in the event of a fault, overload or short-circuit in the consumer's installation, protecting the utility line.

In addition, they provide the consumer with:

- Protection for the installation as a whole, with the possibility of adding a Vigi earth-leakage protection module
- The possibility of downstream selectivity.

This type of ComPacT NSX is often used in conjunction with an ComPacT INV switch-disconnector located outside the consumer's building and providing the visible-break function.

This means the operator can directly see, through a transparent cover, the physical separation of the main contacts. The ComPacT INV range is also suitable for isolation with positive contact indication.

This means utility operators can work on the service-connection unit after isolating it from the upstream line.



ComPacT NSX with MicroLogic 2 AB

DB436766.ai

C251V4/2D250 eps

B

ComPacT NSX Special Applications

Protection of Public Distribution Systems with MicroLogic 2-AB



DB438766.ai

B

Protection

Settings are made using the adjustment dials with fine-adjustment possibilities and a lead-seal fixture.

Overloads: Long-time protection (I_r)

Inverse-time thermal protection against overloads with an adjustable current pick-up I_r and a very short, non-adjustable time delay t_r (15 seconds for $1.5 \times I_r$).

Short-circuits: Short-time protection (I_{sd}) with fixed time delay

Short-circuit protection with an adjustable pick-up I_{sd} . The short-time pick-up values are high enough to avoid nuisance tripping in the event of transient current spikes.

Short-circuits: Non-adjustable instantaneous protection

Instantaneous short-circuit protection with a fixed pick-up.

Neutral protection

Available on four-pole circuit breakers only. Neutral protection may be set using a three-position switch:

- 4P 3D: neutral unprotected
- 4P 3D + N/2: neutral protection at half the value of the phase pick-up, i.e. $0.5 \times I_r$
- 4P 4D: neutral fully protected at I_r .

Indications

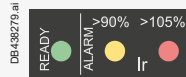

DB438279.ai

Front indications

- Green "Ready" LED: flashes slowly when the circuit breaker is ready to trip in the event of a fault.
- Orange overload pre-alarm LED: steady on when $I > 90\% I_r$.
- Red overload LED: steady on when $I > 105\% I_r$.

Remote indications

An SDx relay module installed inside the circuit breaker can be used to remote the overload-trip signal. This module receives the signal from the MicroLogic electronic trip unit via an optical link and makes it available on the terminal block. The signal is cleared when the circuit breaker is closed.

The module is described in detail in the section dealing with accessories [page C-31](#).



PS10337.aps

SDx remote indication relay module with its terminal block

ComPacT NSX Special Applications

Protection of Public Distribution Systems with MicroLogic 2-AB

B

MicroLogic 2.2/2.3 AB

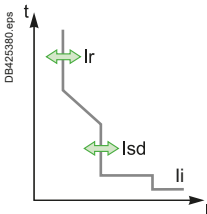

Ratings (A)	In at 40 °C ⁽¹⁾	100	160	240	400
Circuit breaker	ComPacT NSX100	●	-	-	-
	ComPacT NSX160	●	●	-	-
	ComPacT NSX250	●	●	●	-
	ComPacT NSX400	-	-	-	●
	ComPacT NSX630	-	-	-	●

L Long-time protection

Pick-up (A) tripping between 1.05 and 1.20 Ir	Ir	Value depending on trip unit rating (In) and setting on dial								
	In = 100 A	Ir = 40	40	50	60	70	80	90	100	
	In = 160 A	Ir = 90	100	110	120	130	140	150	160	
	In = 240 A	Ir = 140	150	160	170	180	200	220	240	
	In = 400 A	Ir = 260	280	300	320	340	360	380	400	
Time delay (s)	tr	Non-adjustable								
	1.5 Ir	15								
	6 Ir	0.5								
	7.2 Ir	0.35								
Thermal memory		20 minutes before and after tripping								

S_n Short-time protection with fixed time delay

Pick-up (A) accuracy ±10 %	Isd = Ir x ...	1.5	2	3	4	5	6	7	8	10
Time delay (ms)	tsd	Non-adjustable: 20								
	Non-tripping time	20								
	Maximum break time	80								

I Non-adjustable instantaneous protection

Pick-up (A) accuracy ±15 %	Ii non-adjustable	1500	1600	2880	4800					
Time delay (ms)	Non-tripping time	10								
	Maximum break time	50								

[1] If the trip units are used in high-temperature environments, the MicroLogic setting must take into account the thermal limitations of the circuit breaker. See the temperature derating table.

Technical details

Advantages of the AB trip unit

- Controls the power drawn with respect to contractual power levels. If the contractual level is overrun, the circuit breaker opens and the consumer is not billed excess costs.
- If a short-circuit occurs, the circuit breaker opens and the upstream HRC fuses on utility lines are not affected. No expensive utility servicing is billed to the consumer.

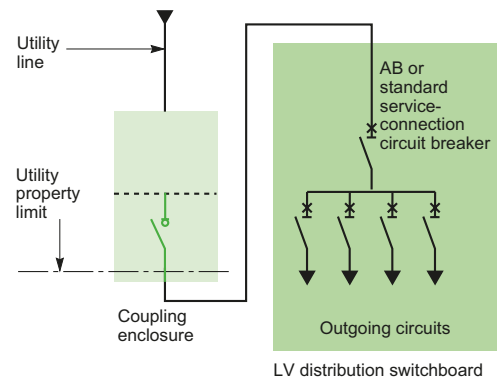

Consumer connection diagram

ComPacT NSX Special Applications

ComPacT NSX MicroLogic Vigi 4-AB Trip Unit with Embedded Earth Leakage Protection

The ComPacT NSX range for public distribution is now complemented with a new type of MicroLogic AB trip unit including both circuit protection and earth leakage protection. It means that the earth leakage protection, previously located within the VigiPacT add-on, will be embedded within the existing size of the MicroLogic AB trip unit.

B

C2544B250.eps

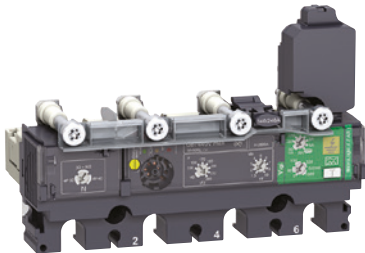

MicroLogic Vigi 4.2-AB trip unit

MicroLogic Vigi 4-AB

ComPacT ELCB ⁽¹⁾ equipped with that "new" earth leakage trip unit MicroLogic AB are installed as an incoming device for installation connected with the public LV distribution system. With respect to the utility requirement, it ensures the same functions as the standard circuit breaker: limitation of consumption, selectivity upstream and downstream, combination with ComPacT INV to ensure the visible break or positive contact indication.

Short Circuit and Overload Protections

Settings are made using the rotary dial with fine adjustment capabilities and lead-seal fixture.

Overload: Long-Time Protection (I_r)

Inverse time protection against overload with an adjustable current pick-up I_r set using a dial and a very short non-adjustable time delay t_r (15 seconds at 1.5 I_r).

Short-Circuit: Short-Time Protection with Fixed Time Delay (I_{sd})

That protection is set with an adjustable pick-up I_{sd} . The short time pick-up values are high enough to avoid nuisance tripping in the event of transient current spikes.

Short Circuit: Non-Adjustable Instantaneous Protection (with a Fix Pick-up)

Neutral Protection

Available on four-pole ComPacT NSX MicroLogic Vigi 4-AB only, the neutral protection may be set using the dedicated coding wheel to meet the following configurations: 4P 3D, 4P 3D + N/2 or 4P 4D. (same as for the MicroLogic 2-AB)

Earth Leakage Protections

Adjustable leakage threshold ($I_{\Delta n}$) and adjustable time threshold (Δt) by using the two dials on the green area of the trip unit.

The ComPacT NSX MicroLogic Vigi 4-AB, embedding a MicroLogic AB can only be "Trip" type, the "Alarm" version (as for MicroLogic Vigi 4 and 7 E) doesn't exist.

Power Supply

The trip unit is self supplied, and so does not need any external source. It works even when fed by 2 phases only!

Sensitivity $I_{\Delta n}$ (A)

- Type A: 30mA - 100mA - 300mA - 500mA - 1A - 3A - 5A (for the ratings 100 to 240A)
- Type A: 300mA - 500mA - 1A - 3A - 5A - 10A (for the rating 400A)

Caution: "OFF" setting of $I_{\Delta n}$ is possible, it cancels the earth leakage protection, in that case, the ComPacT NSX MicroLogic Vigi 4-AB behaves as a standard circuit breaker. "OFF" position is located on the highest side of the coding wheel.

Intentional Delay Δt (S)

Case $I_{\Delta n} = 30\text{mA}$: 0 sec (whatever the setting)

Case $I_{\Delta n} > 30\text{mA}$: 0 - 60ms - 150ms - 500ms - 1sec (by setting)

Operated Voltage

200 to 440 VAC (only) - 50/60 Hz

Operating Safety

The earth leakage protection is a user safety device. It must be regularly tested using the test button (T) that simulates a real current leakage within the toroid.

When $I_{\Delta n}$ is set on the OFF position, press the T will cancel any test.

As for standard circuit breaker, the circuit breaker with MicroLogic Vigi 4-AB can be reset after any fault by operating an OFF/ON procedure.

ComPacT NSX Special Applications

ComPacT NSX MicroLogic Vigi 4-AB Trip Unit with Embedded Earth Leakage Protection

Indications

Front Indications

- Green "Ready" LED: flashes slowly when the circuit breaker is ready to trip in case of a fault.
- Orange overload pre-alarm LED: steady ON when $I > 90\% I_r$.
- Red overload LED: steady ON when $I > 105\% I_r$.
- Yellow Screen: indicates an earth leakage fault (reset when the device is operated OFF/ON).

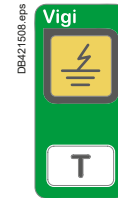
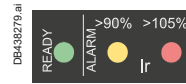

Alarming and Fault Differentiation

- An overload trip signal can be remotely available by installing an SDx relay module inside the circuit breaker.
 - An earth leakage pre-alarm can be remotely available by installing an SDx module, only on the ComPacT NSX MicroLogic Vigi 4-AB.
- This module receives the signal from the MicroLogic electronic trip unit via an optical link and makes it available on the terminal block. The signal is reset when the breaker is operated.



MicroLogic Vigi 4-AB (Earth Leakage "Trip" Version Only)

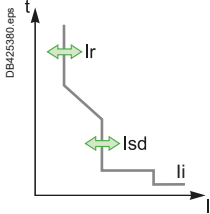

Ratings (A)	In at 40 °C [1]	100	160	240	400
Circuit breaker	ComPacT NSX100	●			
	ComPacT NSX160	●	●		
	ComPacT NSX250	●	●	●	
	ComPacT NSX400				●
	ComPacT NSX630				●

L Long-time protection											
Pick-up (A)	Ir	Value depending on the rating (In) and the dial setting (9 positions)									
tripping between 1.05 and 1.20 Ir	In = 100 A	Io =	40	40	40	50	60	70	80	90	100
	In = 160 A	Io =	90	90	100	110	120	130	140	150	160
	In = 240 A	Io =	140	140	150	160	170	180	200	220	240
	In = 400 A	Io =	260	260	280	300	320	340	360	380	400

Time delay (s)	tr	Non-adjustable									
accuracy 0 to -20%	at	1.5 x Ir	tr = 15 s								
	at	6 x Ir	tr = 0.5 s								
	at	7.2 x Ir	tr = 0.35 s								

Thermal memory 20 minutes before and after tripping

S ₀ Short-time protection with fixed time delay											
Pick-up (A)	Isd = Ir x ...	1.5	2	3	4	5	6	7	8	10	
accuracy ±10 %											
Time delay (ms)	tsd	Non-adjustable									
	Non-tripping time	20									
	Maximum break time	80									

I Instantaneous protection											
Pick-up (A)	Ii non-adjustable	1500	1600	2880	4800						
	accuracy ±15 %										
	Non-tripping time	10 ms									
	Maximum break time	50 ms									

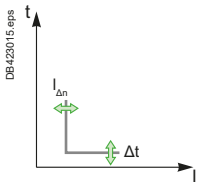

R Earth leakage protection											
Sensitivity (A)	Type A, adjustable (9 positions)										
	In = 100 A	IΔn =	0.03	0.03	0.1	0.3	0.5	1	3	5	OFF
	In = 160 A	IΔn =	0.03	0.03	0.1	0.3	0.5	1	3	5	OFF
	In = 240 A	IΔn =	0.03	0.03	0.1	0.3	0.5	1	3	5	OFF
	In = 400 A	IΔn =	0.3	0.3	0.5	1	3	5	10	10	OFF
Time delay Δt (ms)	Adjustable	Δt =	0	60 [2]	150 [2]	500 [2]	1000 [2]				
	Maximum break time (ms)		<40	<140	<300	<800	<1500				

[1] For the use in high temperature environment, take into account the thermal limitation of the breaker.
 [2] The time delay (Δt) is mandatory and designed "Δt = 0" when the IΔn dial is set on 30mA (0.03). The time delay has no effect when the dial IΔn is set to the "OFF" position.

ComPacT NSX Special Applications

Generator Protection with MicroLogic 2.2 G

MicroLogic G trip units are used for the protection of systems supplied by generators or comprising long cable lengths. They can be mounted on all ComPacT NSX100/160/250 circuit breakers. With extensive setting possibilities, MicroLogic 5 offers the same functions from 100 to 630 A. A thermal-magnetic trip unit is also available for the NSX100 to 250 (see page B-6).

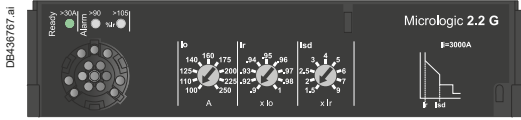

Circuit breakers equipped with MicroLogic G trip units help protect systems supplied by generators (lower short-circuit currents than with transformers) and distribution systems with long cable lengths (fault currents limited by the resistance of the cable).

Protection

Settings are made using the adjustment dials with fine adjustment possibilities.

Overloads: Long-time protection (Ir)

Inverse-time thermal protection against overloads with an adjustable current pick-up Ir and a very short, non-adjustable time delay tr (15 seconds for 1.5 x Ir).

Short-circuits: Short-time protection (Isd) with fixed time delay

Short-circuit protection with an adjustable pick-up Isd, delayed 200 ms, in compliance with the requirements of marine classification companies.

Short-circuits: Non-adjustable instantaneous protection (Ii)

Instantaneous short-circuit protection with a fixed pick-up required for generator protection.

Neutral protection

- On 3-pole circuit breakers, neutral protection is not possible.
- On four-pole circuit breakers, neutral protection may be set using a three-position switch:
 - 4P 3D: neutral unprotected
 - 4P 3D + N/2: neutral protection at half the value of the phase pick-up, i.e. 0.5 x Ir
 - 4P 4D: neutral fully protected at Ir.

Indications

Front indications



- Green "Ready" LED: flashes slowly when the circuit breaker is ready to trip in the event of a fault.
- Orange overload pre-alarm LED: steady on when $I > 90\% I_r$.
- Red overload LED: steady on when $I > 105\% I_r$.

Remote indications

An SDx relay module installed inside the circuit breaker can be used to remote the overload-trip signal.

This module receives the signal from the MicroLogic electronic trip unit via an optical link and makes it available on the terminal block. The signal is cleared when the circuit breaker is closed.

The module is described in detail in the section dealing with accessories.



SDx remote indication relay module with its terminal block

ComPacT NSX Special Applications Generator Protection with MicroLogic 2.2 G

MicroLogic 2.2 G

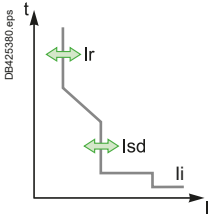

Ratings (A)	In at 40 °C [1]	40	100	160	250
Circuit breaker	ComPacT NSX100	<input checked="" type="radio"/>	<input checked="" type="radio"/>	-	-
	ComPacT NSX160	<input checked="" type="radio"/>	<input checked="" type="radio"/>	<input checked="" type="radio"/>	-
	ComPacT NSX250	<input checked="" type="radio"/>	<input checked="" type="radio"/>	<input checked="" type="radio"/>	<input checked="" type="radio"/>

L Long-time protection																																																								
Pick-up (A) tripping between 1.05 and 1.20 I _r	<table border="1"> <thead> <tr> <th>I_o</th> <th colspan="10">Value depending on trip unit rating (I_n) and setting on dial</th> </tr> </thead> <tbody> <tr> <td>I_n = 40 A</td> <td>I_o =</td> <td>18</td> <td>18</td> <td>20</td> <td>23</td> <td>25</td> <td>28</td> <td>32</td> <td>36</td> <td>40</td> </tr> <tr> <td>I_n = 100 A</td> <td>I_o =</td> <td>40</td> <td>45</td> <td>50</td> <td>55</td> <td>63</td> <td>70</td> <td>80</td> <td>90</td> <td>100</td> </tr> <tr> <td>I_n = 160 A</td> <td>I_o =</td> <td>63</td> <td>70</td> <td>80</td> <td>90</td> <td>100</td> <td>110</td> <td>125</td> <td>150</td> <td>160</td> </tr> <tr> <td>I_n = 250 A (NSX250)</td> <td>I_o =</td> <td>100</td> <td>110</td> <td>125</td> <td>140</td> <td>150</td> <td>176</td> <td>200</td> <td>225</td> <td>250</td> </tr> </tbody> </table>	I _o	Value depending on trip unit rating (I _n) and setting on dial										I _n = 40 A	I _o =	18	18	20	23	25	28	32	36	40	I _n = 100 A	I _o =	40	45	50	55	63	70	80	90	100	I _n = 160 A	I _o =	63	70	80	90	100	110	125	150	160	I _n = 250 A (NSX250)	I _o =	100	110	125	140	150	176	200	225	250
I _o	Value depending on trip unit rating (I _n) and setting on dial																																																							
I _n = 40 A	I _o =	18	18	20	23	25	28	32	36	40																																														
I _n = 100 A	I _o =	40	45	50	55	63	70	80	90	100																																														
I _n = 160 A	I _o =	63	70	80	90	100	110	125	150	160																																														
I _n = 250 A (NSX250)	I _o =	100	110	125	140	150	176	200	225	250																																														
	I _r = I _o x ... 9 fine-adjustment settings from 0.9 to 1 for each I _o value																																																							
Time delay (s) accuracy 0 to -20 %	<table border="1"> <thead> <tr> <th>t_r</th> <th>Non-adjustable</th> </tr> </thead> <tbody> <tr> <td>1.5 x I_r</td> <td>15</td> </tr> <tr> <td>6 x I_r</td> <td>0.5</td> </tr> <tr> <td>7.2 x I_r</td> <td>0.35</td> </tr> </tbody> </table>	t _r	Non-adjustable	1.5 x I _r	15	6 x I _r	0.5	7.2 x I _r	0.35																																															
t _r	Non-adjustable																																																							
1.5 x I _r	15																																																							
6 x I _r	0.5																																																							
7.2 x I _r	0.35																																																							
Thermal memory	20 minutes before and after tripping																																																							

S ₀ Short-time protection with fixed time delay												
Pick-up (A) accuracy ±10 %	<table border="1"> <thead> <tr> <th>I_{sd} = I_r x ...</th> <th>1.5</th> <th>2</th> <th>2.5</th> <th>3</th> <th>4</th> <th>5</th> <th>6</th> <th>7</th> <th>8</th> <th>9</th> </tr> </thead> </table>	I _{sd} = I _r x ...	1.5	2	2.5	3	4	5	6	7	8	9
I _{sd} = I _r x ...	1.5	2	2.5	3	4	5	6	7	8	9		
Time delay (ms)	<table border="1"> <thead> <tr> <th>t_{sd}</th> <th>Non-adjustable</th> </tr> </thead> <tbody> <tr> <td>Non-tripping time</td> <td>140</td> </tr> <tr> <td>Maximum break time</td> <td>200</td> </tr> </tbody> </table>	t _{sd}	Non-adjustable	Non-tripping time	140	Maximum break time	200					
t _{sd}	Non-adjustable											
Non-tripping time	140											
Maximum break time	200											

I Non-adjustable instantaneous protection																
Pick-up (A) accuracy ±15 %	<table border="1"> <thead> <tr> <th>I_i non-adjustable</th> <th>600</th> <th>1500</th> <th>2400</th> <th>3000</th> </tr> </thead> <tbody> <tr> <td>Non-tripping time</td> <td>15 ms</td> <td></td> <td></td> <td></td> </tr> <tr> <td>Maximum break time</td> <td>50 ms</td> <td></td> <td></td> <td></td> </tr> </tbody> </table>	I _i non-adjustable	600	1500	2400	3000	Non-tripping time	15 ms				Maximum break time	50 ms			
I _i non-adjustable	600	1500	2400	3000												
Non-tripping time	15 ms															
Maximum break time	50 ms															

[1] If the trip units are used in high-temperature environments, the MicroLogic setting must take into account the thermal limitations of the circuit breaker. See the temperature derating table.



ComPacT NSX Special Applications

Protection of Industrial Control Panels

ComPacT NSX circuit breakers are also used in industrial control panels.

They serve as an incoming devices or can be combined with contactors to protect motor feeders:

- Compliance with worldwide standards including IEC 60947-2 and UL 60947-4/CSA 22-2 no. 14
- Overload and short-circuit protection
- Isolation with positive contact indication, making it possible to isolate machines from all power sources
- Installation in universal and functional type enclosures
- NA switch-disconnector version.

B

DB438641.ai

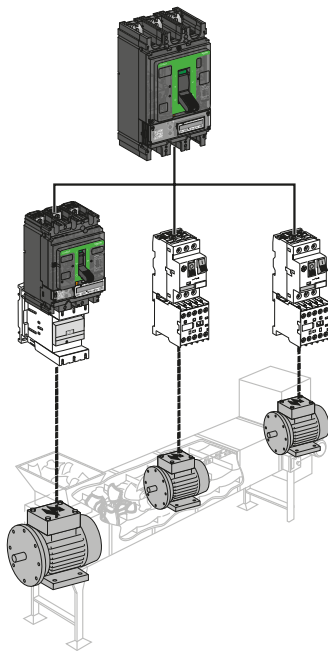

DB119234.eps



Industrial Control Panels

ComPacT NSX circuit breakers equipped for public distribution or motor protection functions as described in the previous pages can be used in industrial control panels. The accessories for the ComPacT NSX range are suitable for the special needs of these switchboards.

Auxiliaries

All auxiliaries can be added to the circuit breaker by the user:

- Padlocking devices (in the OFF position)
- Rotary handle
- Status-indication auxiliary contacts (ON, OFF and tripped)
- Shunt (MX) or undervoltage (MN) releases
- Early-make or early-break contacts.

Rotary handle

Direct or extended versions for mounting up to 600 mm behind the front:

- Black front with black handle
- Yellow front with red handle (for machine tools or emergency off as per IEC 204/VDE 0013).

All rotary handles can be padlocked in the OFF position. Optional door interlock, recommended for MCC panels (motor control centres).

When the device is equipped with an extended rotary handle, a control accessory mounted on the shaft makes it possible to operate the device with the door open. The device can be padlocked in the OFF position in compliance with UL508.

Early-make or early-break contacts

These contacts can be used respectively to supply an MN undervoltage release before the circuit breaker closes or to open the contactor control circuit before the circuit breaker opens.

Special functions

- Indication of thermal overloads with the SDx module.
- Early opening of the contactor for overload faults with the SDTAM module.
- Links with PLCs via the communication system.
- Measurement of all electrical parameters with MicroLogic E.
- Programmable alarms with MicroLogic 5 and 6.

Installation in Enclosures

ComPacT circuit breakers can be installed in a metal enclosure together with other devices (contactors, motor-protection circuit breakers, LEDs, etc.).

ComPacT NSX Special Applications

Protection of Industrial Control Panels



Compliance with North American Industrial Control Equipment Standards

ComPacT NSX devices have received UL508/CSA 22-2 no. 14 approval for industrial control equipment of the "Manual Motor Controller", "Across the Line Starter", "General Use" and "Disconnecting Means" types. Type NA devices are switch-disconnectors that must always be protected upstream.

UL508 approval

Circuit breakers	Trip units	Approvals
ComPacT NSX100 to 630 F/N/H	TMD, MicroLogic 2, 5 and 6	General Use Motor Disconnecting Means
	NA, MA, MicroLogic 1.3 M, 2.2 M, 2.3 M, MicroLogic 6.2 E-M and 6.3 E-M	Manual Motor Controller Across the Line Starter Motor Disconnecting Means

Table of 3-phase motor ratings in hp (1 hp = 0.7457 kW)

V AC ratings		115	230	460	575
TMD MicroLogic 2, 5 and 6	NA, MA MicroLogic 1.3 M, 2.2 M, 2.3 M MicroLogic 6.2 E-M and 6.3 E-M				
25	25	3	7.5	15	20
50	50	7.5	15	30	40
100	100	15	30	75	100
160	150	25	50	100	150
250	220	40	75	150	200
400	320	-	125	250	300
550	500	-	150	350	500

The deratings indicated on pages E-14 to E-17 apply to TMD, MicroLogic 2, 5 and 6 trip units, rated at 40 °C

ComPacT NSX Special Applications

16 Hz 2/3 Network Protection - MicroLogic 5 A-Z Trip Unit

ComPacT NSX circuit breakers may be used on 16 Hz 2/3 systems with special thermal-magnetic and electronic (MicroLogic 5 A-Z) trip units.

B

16 Hz 2/3 Networks

Single-phase distribution networks with a frequency of 16 Hz 2/3 are used for railroad applications in certain European countries.

Breaking Capacity for 16 Hz 2/3 at 250/500 V

ComPacT NSX circuit breakers of the 3P 3D type protect 16 Hz 2/3 networks at 250 V or 500 V.

They can be equipped with either:

- A TM-D thermal-magnetic trip unit for ComPacT NSX100 to 250
- Or an electronic MicroLogic 5.2 A-Z trip unit for ComPacT NSX100 to 250 or a 5.3 A-Z for ComPacT NSX400/630.

The possible breaking-capacity performance levels are B, F, N and H as indicated below.

Breaking capacity I_{cu}

Operating voltage	Performance	TMD and MicroLogic 5 A-Z trip units			
		B	F	N	H
250 V/500 V	I _{cu} (kA)	25	36	50	70

Protection

TM-D Thermal-Magnetic Trip Units

The 16 Hz 2/3 frequency does not modify the thermal settings with respect to those at 50 Hz (see page B-6). The magnetic pick-ups are modified as shown below.

Magnetic protection for ComPacT NSX 100/160/250 at 50 Hz and at 16 Hz 2/3

Rating (A) I _n at 40 °C		16	25	32	40	50	63	80	100	125	160	200	250	
Pick-up (A) I _i accur. ±20%	Fixed												Adjustable	
NSX100	50Hz	190	300	400	500	500	500	640	800					
	16Hz 2/3	170	270	360	450	450	450	580	720					
NSX160/250	50Hz	190	300	400	500	500	500	640	800	1250	1250			
	16 Hz 2/3	170	270	360	450	450	450	580	720	1100	1100	4.5 to 9 I _n		

MicroLogic 5 A-Z Trip Units

MicroLogic 5.2 A-Z and 5.3 A-Z are dedicated to 16 Hz 2/3 networks.

They use a suitable sampling frequency. The protection settings are identical to those of MicroLogic 5 A (see page B-12). They also offer a current-measurement function for this specific frequency.

Trip-Unit Selection

Rating	16	63	100	160	250	400	630
ComPacT							
NSX100	TM-D						
NSX160		TM-D					
NSX250				TM-D			
NSX100 to 250			MicroLogic 5.2 A-Z				
NSX400/630						MicroLogic 5.3 A-Z	

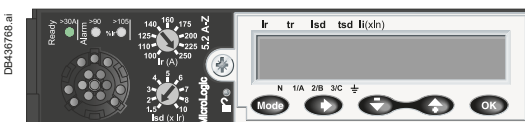

Wiring for NSX100 to 630 A

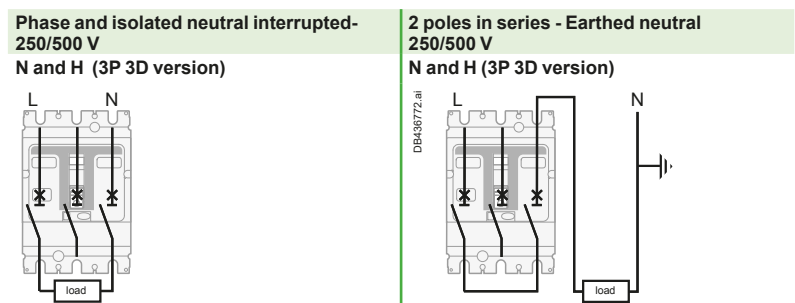

ComPacT NSXm Special Applications

Protection of 400 Hz Systems

ComPacT NSXm circuit breakers may be used on 400 Hz systems.

Breaking Capacity in 400 Hz, 440 V Systems

The power levels of 400 Hz applications rarely exceed a few hundred kW with relatively low short circuit current, generally not exceeding four times the rated current.

Circuit breaker	Max. Breaking Capacity at 400 Hz
NSXm	10 kA

Thermal-Magnetic Trip Units

Thermal-Magnetic trip units require the current rating (In) to be derated and the magnetic trip setting (Ii) to be increased.

Current Rating (In) and Magnetic Trip Setting (Ii) Rerating

Circuit breaker	Maximum setting Coefficient	Max Ir setting at 400 Hz	Magnetic Ii coefficient at 400 Hz
NSXm	0.9	144	1.6

Shunt Trip (MX) or Undervoltage Trip (MN) Voltage Release at 400 Hz and 440 V

Undervoltage releases (MN) rated 24 V AC/DC, 48 V AC/DC, or 110/130 V AC/DC are 400 Hz compliant with their nominal voltages. For voltages greater than 110/130 V AC/DC, please contact Schneider Electric for additional information. Shunt Trips (MX), please contact Schneider Electric.



ComPacT NSXm TM-D

C12H3TM160L.eps



ComPacT NSX Special Applications

Protection of 400 Hz Systems

ComPacT NSX circuit breakers may be used on 400 Hz systems.

B



MicroLogic TM-D trip unit

400 Hz Distribution Systems

The main 400 Hz applications are in aeronautics and certain military ships. Modern aircraft have three-phase 115/200 V 400 Hz networks.

Impact on Protective Devices

Due to the higher frequency, circuit breakers are subjected to additional temperature rise for identical current levels, resulting from higher losses caused by Foucault currents and an increase in the skin effect (reduction in the useful CSA of conductors). To remain within the rated temperature-rise limits of devices, current derating is required.

The power levels of 400 Hz applications rarely exceed a few hundred kW with relatively low short-circuit currents, generally not exceeding four times the rated current.

The standard ComPacT NSX range is suitable for 400 Hz applications if derating coefficients are applied to the protection settings. See the derating table below.

Breaking Capacity of ComPacT NSX Circuit Breakers in 400 Hz, 440 V Systems

Circuit breaker	Breaking capacity I _{cu}
NSX100	10 kA
NSX160	10 kA
NSX250	10 kA
NSX400	10 kA
NSX630	10 kA

Trip Units Equipped with Thermal-Magnetic Protection

The 400 Hz current settings are obtained by multiplying the 50 Hz values by the following adaptation coefficient:

- K1 for thermal trip units
- K2 for magnetic trip units.

These coefficients are independent of the trip-unit setting.

Thermal trip units

The current settings are lower at 400 Hz than at 50 Hz ($K1 < 1$).

Magnetic trip units

The current settings are conversely higher at 400 Hz than at 50 Hz ($K2 > 1$).

Consequently, when the trip units are adjustable, they must be set to the minimum value.

Adaptation coefficients for thermal-magnetic trip units

Circuit breaker	Trip unit	I _n (A) 50Hz	Thermal at 40°C		I _i (A) 50Hz	Magnetic	
			K1	400 Hz		K2	400 Hz
NSX100	TM16G	16	0.95	15	63	1.6	100
	TM25G	25	0.95	24	80	1.6	130
	TM40G	40	0.95	38	80	1.6	130
	TM63G	63	0.95	60	125	1.6	200
NSX100	TM16D	16	0.95	15	240	1.6	300
	TM25D	25	0.95	24	300	1.6	480
	TM40D	40	0.95	38	500	1.6	800
	TM63D	63	0.95	60	500	1.6	800
	TM80D	80	0.9	72	650	1.6	1040
	TM100D	100	0.9	90	800	1.6	1280
	NSX160	TM80D	80	0.9	72	650	1.6
NSX160	TM100D	100	0.9	90	800	1.6	1280
	TM125D	125	0.9	112.5	1250	1.6	2000
	TM160D	160	0.9	144	1250	1.6	2000
	NSX250	TM100D	100	0.9	90	800	1.6
NSX250	TM160D	160	0.9	144	1250	1.6	2000
	TM200D	200	0.9	180	1000 to 2000	1.6	1600 to 3200
	TM250D	250	0.9	225	1250 to 2500	1.6	2000 to 4000

Example

NSX100 equipped with a TM16G with 50 Hz settings I_r = 16 A and I_i = 63 A. 400 Hz settings I_r = 16 x 0.95 = 15 A and I_i = 63 A x 1.6 = 100 A.

ComPacT NSX Special Applications

Protection of 400 Hz Systems

Protection

MicroLogic Electronic Trip Units

MicroLogic 2.2, 2.3 or 5.2, 5.3 with E measurement functions are suitable for 400 Hz. The use of electronics offers the advantage of greater operating stability when the frequency varies. However the units are still subject to temperature rise caused by the frequency.

The practical consequences are:

- Limit settings: see the I_r derating table below.
- The long-time, short-time and instantaneous pick-ups are not modified (see page B-10 or page B-12).
- The accuracy of the displayed measurements is 2 % (class II).

Thermal derating: maximum I_r setting

Circuit breaker	Maximum setting coefficient	Max. I _r setting at 400 Hz
NSX100	1	100
NSX250	0.9	200
NSX400	0.8	320
NSX630	0.63	400

Example

An NSX250N, equipped with a MicroLogic 2.2, I_r = 250 A at 50 Hz, must be limited to use at I_r = 250 x 0.9 = 225 A.

Its short-time pick-up with fixed time delay is adjustable from 1.5 to 10 I_r (337.5 to 2250 A).

The instantaneous pick-up remains at 3000 A.

OF Auxiliary Contacts in 400 Hz Networks

Electrical characteristics of auxiliary contacts

Contacts	Standard		Low level	
	AC12	AC15	AC12	AC15
Utilization cat. (IEC 60947-5-1)	AC12	AC15	AC12	AC15
Operational current ^{24 V} (A)	6	6	5	3
48 V	6	6	5	3
110 V	6	5	5	2.5
220/240 V	6	4	5	2
380/415 V	6	2	5	1.5

MN and MX Voltage Releases for ComPacT NSX100/630 at 400 Hz and 440 V

For circuit breakers on 400 Hz systems, only 125 V DC MN or MX releases may be used. The release must be supplied by the 400 Hz system via a rectifier bridge (to be selected from the table below) and an additional resistor with characteristics depending on the system voltage.

U (V) 400 Hz	Rectifier	Additional resistor
220/240 V	Thomson 110 BHz or General Instrument W06 or Semikron SKB at 1.2/1.3	4.2 kΩ-5 W
380/420 V	Semikron SKB at 1.2/1.3	10.7 kΩ-10 W

Note: Other models of rectifier bridges may be used if their characteristics are at least equivalent to those stated above.

SDx Indication Contacts

The SDx module may be used in 400 Hz systems for voltages from 24 to 440 V. An SDx relay module installed inside the circuit breaker can be used to remote the overload-trip signal.

This module receives the signal from the MicroLogic electronic trip unit via an optical link and makes it available on the terminal block. The signal is cleared when the circuit breaker is closed.

These outputs can be reprogrammed to be assigned to other types of tripping or alarm (see page C-31).



MicroLogic 5 E trip unit

C2598E250 eps



OF auxiliary contact

L426454 eps



MX or MN voltage release

PB120468 eps

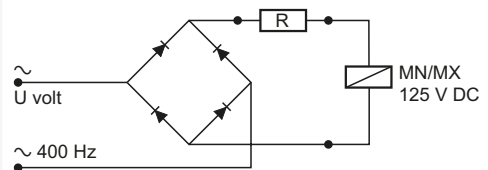

Wiring diagram

DB11579 eps



SDx remote indication relay module with its terminal block

PB103377 eps



ComPacT NSX Special Applications

ComPacT NSX400K at 1000 V AC

The ComPacT NSX range includes the NSX400K 3P and 4P at 800 VAC and 1000 VAC models, with adjustable electronic trip unit Micrologic 2.3 rating 250A and 400A.

The ComPacT NSX400K offers the following features of the ComPacT NSX range:

- Compliance with most standards
- Service breaking capacity of 10 kA at 1000 VAC and 36 kA at 800 VAC
- Suitable for isolation with positive break indication
- Accessories, MN, MX, ON/OFF, auxiliary, motor mechanism, and rotary handles.

B



NSX400K.eps

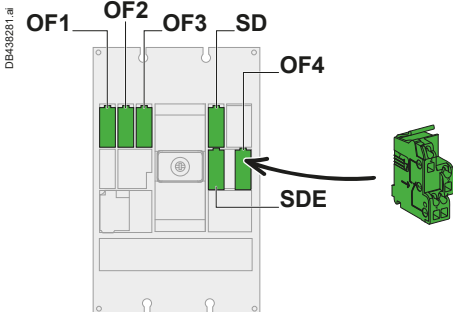

DB438261.ai

Compliance with Standards

- International: IEC 60947-1 to 5
- Europe: EN 60947

Suitability for Isolation and People Safety

All Compact circuit-breakers are suitable for isolation as defined in IEC standard 60947-2. The operating handle cannot indicate the "off" position unless the contacts are actually open. Fitting a rotary handle or a motor mechanism does not alter the reliability of the position indication system.

For protection against direct contact with live parts, Compact circuit breakers may be installed through the door of Class II switchboards (as per IEC 60664).

Electrical Characteristics

Number of poles	3 & 4		
IEC 60947-2 and EN 60947-2			
Rated insulation voltage	Ui (VAC)	1000	
Rated impulse withstand voltage	Uimp (kV)	8	
Rated operational voltage	Ue (V)	AC 50/60 Hz	1000
Ultimate breaking capacity	Icu (kA rms)	AC 1000 V	10
		AC 800 V	36
Service breaking capacity	Ics (% Icu)	AC 1000 V	10
		AC 800 V	10
Suitability for isolation	■		
Utilization category	A		
Pollution degree	3		

Electronic Trip Unit

Factory mounted	Refer to Micrologic 2.3 section for trip settings
-----------------	---

Auxiliaries for Indication, Measurement and Control

- Direct or extended rotary handles
- Padlocking and keylocking devices
- Motor mechanism featuring short closing time
- Status indication auxiliary contacts (contact positions, tripped, electrical fault, earth fault)
- Shunt and undervoltage auxiliary releases

ComPacT NSX Special Applications

ComPacT NSX400K at 1000 V AC

Safety Parameters

Fixed front connection.

Supply by the top or the bottom. Connection by cables or busbars.

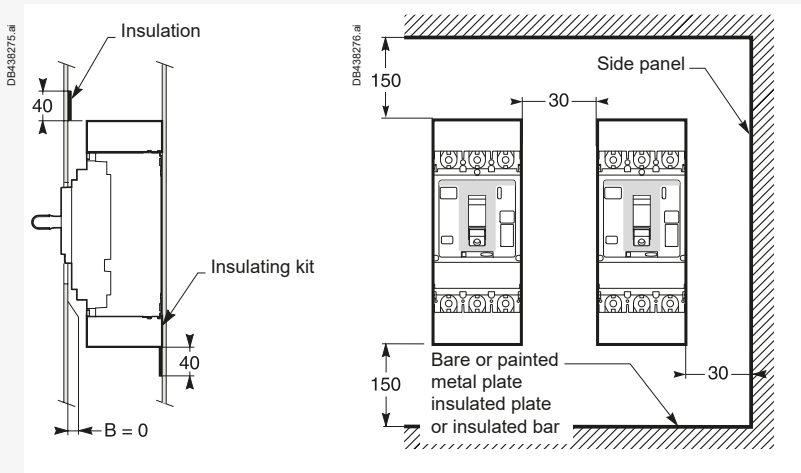

B



Customize Circuit Breaker with Accessories

ComPacT NSXm Accessories and Auxiliaries

Overview	C-2
Power Connection of Fixed Devices	C-4
Insulation of Live Parts.....	C-6
Selection of Auxiliaries.....	C-7
Connection of Auxiliaries.....	C-8
Indication Contacts.....	C-9
Voltage Release	C-10
SDx Module for MicroLogic Vigi 4.1	C-11
Rotary Handles	C-12
Locks and Sealing Accessories	C-14

ComPacT NSX Accessories and Auxiliaries

Overview Fixed Version	C-16
Overview Plug-in and Withdrawable Versions	C-17
Device Installation	C-18
Connection of Fixed Devices	C-20
Connection of Withdrawable and Plug-in Devices	C-22
Insulation of Live Parts.....	C-23
Selection of Auxiliaries.....	C-24
Connection of Electrical Auxiliaries	C-28
Indication Contacts.....	C-30
SDx and SDTAM	C-31
Motor Mechanism	C-32
Remote Tripping.....	C-33
Rotary Handles	C-34
Manual and Automatic Transfer Switch	C-36
Mechanical Interlocking.....	C-37
Mechanical and Electrical Interlocking for Source-Changeover Systems.....	C-38
Automatic Source-Changeover Systems with Controller	C-39
Additional Measurement Module: PowerLogic PowerTag NSX....	C-40
Additional Measurement and Indication Modules	C-44
Locks.....	C-46
Sealing Accessories	C-47
Escutcheons and Protection Collars	C-48

Other Chapters

Select Circuit Breakers and Switch-Disconnectors	A-1
Select Protection	B-1
Smart Panel Integration	D-1
Switchboard Integration.....	E-1
Catalog Numbers	F-1
Glossary	G-1
Additional Characteristics.....	H-1



ComPacT NSXm Accessories and Auxiliaries

Overview

DB438218.ai

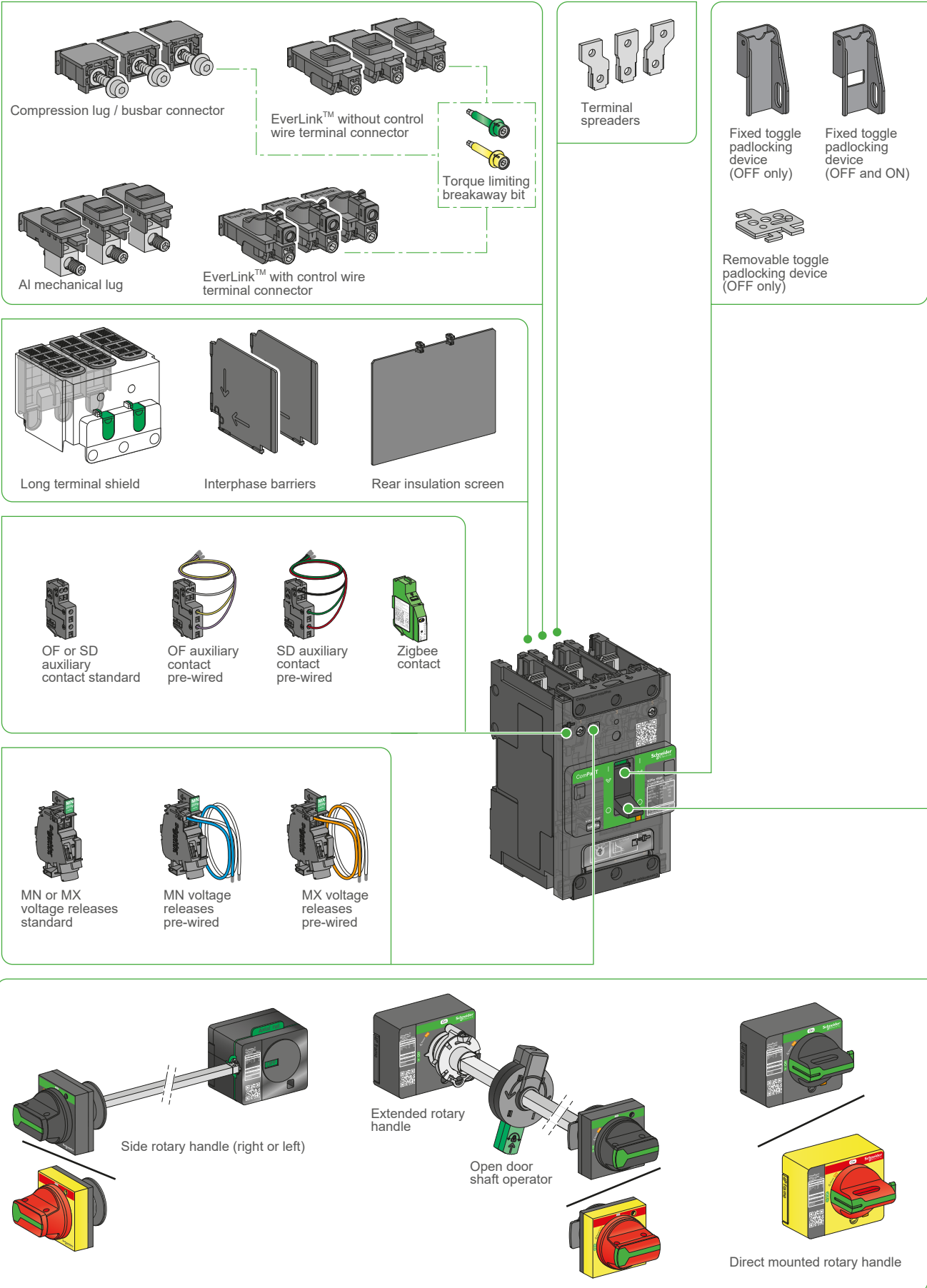

Customize Circuit Breakers with Accessories ComPacT NSXm Accessories and Auxiliaries

Overview

DB438219_01

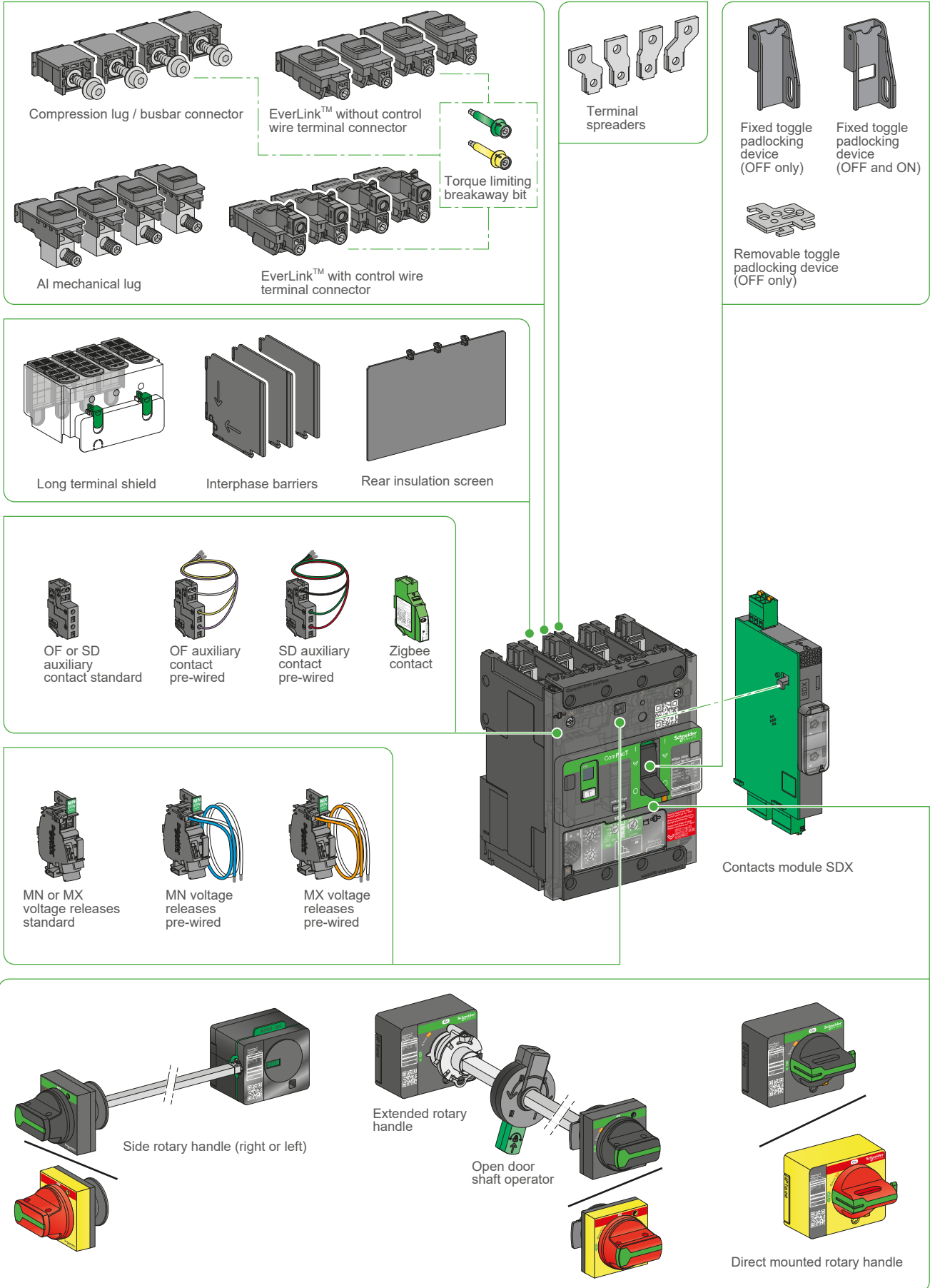

ComPacT NSXm Accessories and Auxiliaries

Power Connection of Fixed Devices



Fixed circuit breakers are designed for standard front connection using cables. Bars or cables with lugs connectors are also available.

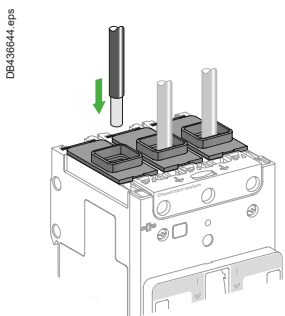
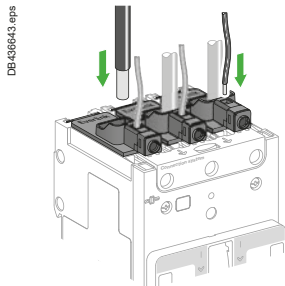
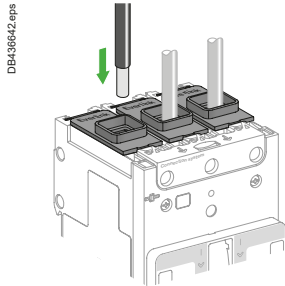

Power Connection

Circuit breakers are delivered with EverLink™ lug connectors for bare cables. They may be delivered with connectors for bars or cables with compression lugs. The connectors can be removed for the installation of one of the 4 kinds of connectors available (EverLink™ lug with control wire terminal, EverLink™ lug, compression lugs/busbar, aluminium mechanical lug). For connection of large cables, a number of solutions with spreaders may be used for both cables with lugs or bars.

Bare Cables

Standard terminal: EverLink™ lug connector

This type of connection uses the EverLink™ system with creep [1] compensation (Schneider Electric patent).

This technique makes it possible to achieve accurate and durable tightening torque, in order to avoid cable creep.

When ordered as spare part, EverLink™ connectors have control wire terminal in order to make some measurement connection (limited to 10 A).

EverLink™ lugs for use with Al or Cu wire

Wire range

Solid/stranded	Flexible	Torque
Power connection 15-160 A (Cu), 15-100 A (Al)		
2.5 - 10 mm ²	2.5 - 10 mm ²	5 N.m ±0.5
16 - 95 mm ²	16 - 70 mm ²	9 N.m ±0.9
Control wire terminal up to 10 A (Cu)		
1.5 - 6 mm ²	0.5 - 6 mm ²	1 N.m ±0.1

Aluminium mechanical connectors up to 125 A

The standard EverLink lugs can be removed for the installation of mechanical lugs. Lugs suitable for copper and aluminum conductors are made of tin-plated aluminum. The mechanical lugs are fastened to the terminals with lug mounting screws, inserted from the bottom of the circuit breaker. The lug cover is held in place with built-in snap features. They are sold as field installable kits.

Aluminium mechanical connectors up to 125 A

Power connection

Ampere rating	Wire range	
	Solid/stranded	Torque
15-125 A (Cu)	2.5 - 6 mm ²	4 N.m ±0.4
15-125 A (Al)	10 - 70 mm ²	5.6 N.m ±0.6

[1] Creep: normal crushing phenomenon of conductors, that is accentuated over time.



ComPacT NSXm Accessories and Auxiliaries

Power Connection of Fixed Devices

Bars or Cables with Lugs

Compression lug/busbar connectors

The ComPacT NSXm circuit breakers may be equipped with captive nuts and M6 screws connectors. These are readily field-installable, simply by removing the EverLink lug and replacing with the appropriate terminal nut.

They are also available factory installed. These terminals may be used for:

- Direct connection of insulated bars or cables with compression (crimp) lugs.
- Terminal extensions offering a wide range of connection possibilities.

Compression lug/busbar connectors, 15-160 A

Power Connection	Torque
≤ 10 mm ²	5 N.m ±0.5
≥ 16 mm ²	9 N.m ±0.9

Interphase barriers or terminal shields are recommended. They are mandatory for certain connection accessories (in which case the interphase barriers are provided).

Crimp lugs large size cables

There are two models, for aluminium and for copper cables. It is necessary to use narrow lugs, compatible with device connections. They must be used with interphase barriers or long terminal shields.

The lugs are supplied with interphase barriers and may be used for the types of cables listed below.

Crimp lugs for use with ComPacT NSXm

Copper cables	size	rigid	70 mm ²	95 mm ²	120 mm ²
		flexible	50 mm ²	70 mm ²	95 mm ²
	crimping	hexagonal barrels or punching			
Aluminium cables	size	rigid		95 mm ²	120 mm ²
	crimping	hexagonal barrels			

Bars

When the switchboard configuration has not been tested, insulated bars are mandatory.

Bar and lugs dimensions

Dimensions	A	B	C	D	E
mm	6.4	≤ 8	≤ 20	7	≥ 17

Spreaders

Spreaders may be used to increase the pitch from 27 mm to 35 mm. Bars or cable lugs can be attached to the ends.

They are provided with M8 screws for power connection and interphase barriers (not compatible with long terminal shield). Rear insulation screens may have to be used too depending on the distance between the live uninsulated parts and the grounded metallic back pan.

Torque Limiting Breakaway Bits

Torque limiting breakaway bits may be used, particularly in the field, to tighten at the right torque EverLink™, compression lug or busbar power connections.

Throwaway tips

Circuit breaker application			Qty per kit
Ampere rating	Torque		
16-160 A	5 N.m		6 or 8
16-160 A	9 N.m		6 or 8

DB436645.eps

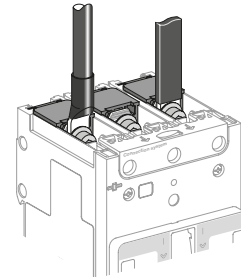

DB418860.eps

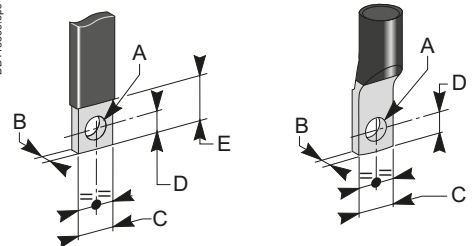

DB436646.eps

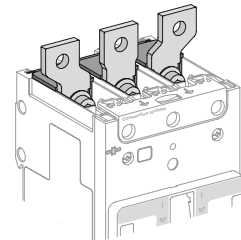

DB438647.eps

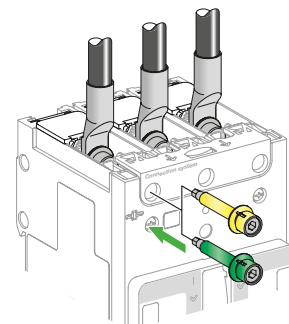

ComPacT NSXm Accessories and Auxiliaries

Insulation of Live Parts

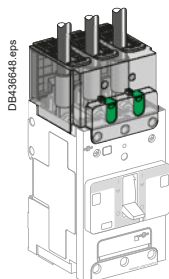

Long terminal shields

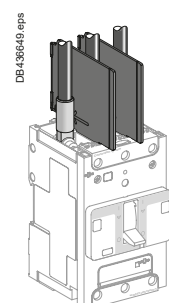

Interphase barriers

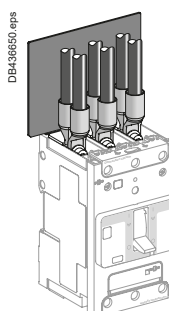

Rear insulating screens

Long Terminal Shields IP40

ComPacT NSXm 3P or 4P can be equipped with long terminal shields. They can be mounted upstream and downstream and are used for protection against direct contact with power circuits. They provide IP40 degree of protection and IK07 mechanical impact protection. Moreover long terminal shields can be mounted after product installation on plate or DIN rail, and can be removed and put in place even if there are auxiliary wires.

They are used for connection with cables or insulated bars.

They are comprised of two parts assembled with 2 locks and/or captive screws, forming an IP40 cover.

- The top part is transparent in order to be able to see the connection through it and is equipped with sliding grids with break marks for precise adaptation to cables or insulated bars.
- The rear part completely blocks off the connection zone. Partially cut squares can be removed to adapt to all types of connection for cables with lugs or copper bars.

Interphase Barriers

Accessories for maximum insulation at the power-connection points:

- They clip easily onto the circuit breaker
- Not compatible with long terminal shield
- 2 ways mounting: short/long insulation.

Rear Insulating Screens

Accessories providing insulation at the rear of the device.

Their use may be mandatory if no long terminal shield depending of the distance between bare conductors and backplate.

The screen dimensions are shown below.

Circuit breaker		NSXm
3P	W x H x thickness (mm)	110 x 84 x 1
4P	W x H x thickness (mm)	145 x 84 x 1



Customize Circuit Breakers with Accessories

ComPacT NSXm Accessories and Auxiliaries

Selection of Auxiliaries

Standard

All ComPacT NSXm circuit breakers and switch-disconnectors have slots for the electrical auxiliaries listed below:

- 2 indication contacts (see page C-9):
 - 1 ON/OFF (OF)
 - 1 trip indication (SD)
- Either 1 MN undervoltage release or 1 MX shunt trip (see page C-10).

Remote Indications

Circuit breakers with MicroLogic Vigi 4.1 may be equipped with an alarming/fault trip indication module to inform before a trip or to identify the type of fault (see page C-11).

All these auxiliaries may be installed with a rotary handle or a toggle handle.

The following drawing indicates auxiliary possibilities depending on the type of device.



Thermal Magnetic Circuit Breaker (TM-D), Switch (NA)

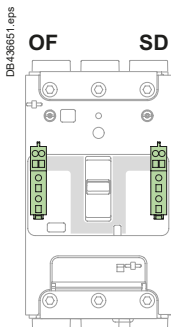

3 poles device

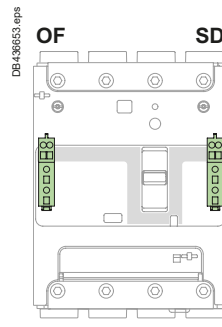
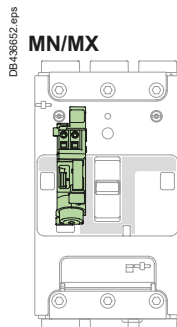

4 poles device

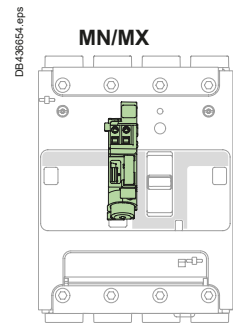

Earth Leakage Circuit Breaker (MicroLogic Vigi 4.1)

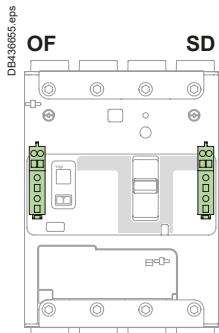

3/4 poles device in 4 poles footprint

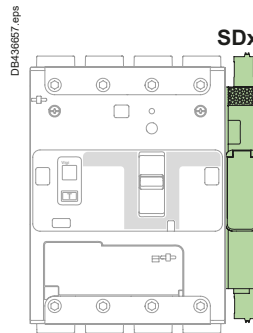
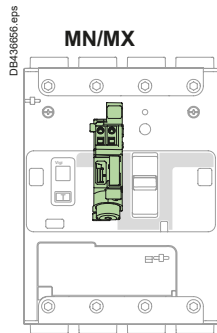

ComPacT NSXm Accessories and Auxiliaries

Connection of Auxiliaries

Wiring

Electrical accessories are fitted with numbered spring terminal blocks for wires. The maximum wire size is 1.5 mm² for auxiliary switches (OF or SD), shunt trip MX or undervoltage release MN.

Electrical accessory wire routing can be exited out any of the four corners of the breaker, under the accessory cover even when using long terminal shield

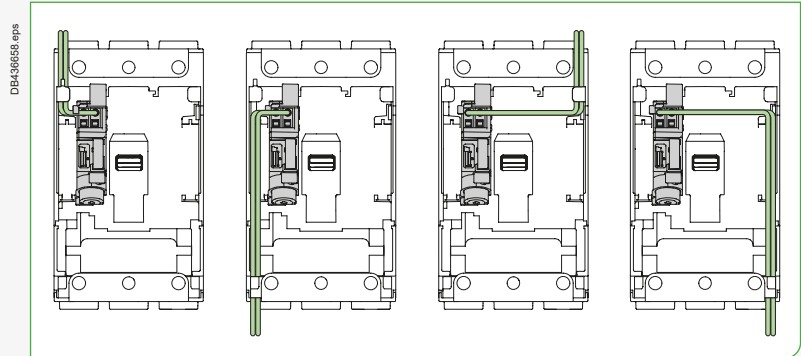

Customize Circuit Breakers with Accessories

ComPacT NSXm Accessories and Auxiliaries

Indication Contacts

Auxiliary and Alarm Indication Contacts

Indication contacts provide remote information of the circuit breaker status and can thus be used for indications, electrical locking, relays, etc.

They are common point changeover type contacts, with a normally open (NO) contact and a normally closed (NC) contact.

Terminals are spring type in order to ensure a fast and reliable connection.

Open/Closed - Auxiliary Switches (OF)

- Indicates the position of the circuit breaker contacts.

Trip Indication - Alarm Switch (SD)

- Indicates that the circuit breaker has tripped due to:
 - An electrical fault (overload, short circuit)
 - The operation of a shunt trip
 - Undervoltage release
 - The “push-to-trip” button
- Resets when the circuit breaker is reset.

Installation and Connection

- The auxiliary switch (OF) and alarm switch (SD) indication contacts snap into cavities behind the front accessory cover of the circuit breaker and their presence is visible on the front face through green flags.
- One model serves for all indication functions depending on where it is fitted in the circuit breaker.
- Each NO and NC spring terminal may be connected by one 0.5...1.5 mm² Flexible copper wire and by two for the common point.

Electrical Characteristics of Auxiliary Contacts

Characteristics						
Rated thermal current (A)	5					
Minimum load	2 mA at 17 V DC					
Utilization cat. (IEC 60947-5-1)	AC12	AC15	DC12	DC13	DC14	
Operational current (A)	24 V AC/DC	5	5	5	2.5	1
	48 V AC/DC	5	5	2.5	1.2	0.2
	110...127 V AC/110 V DC	5	4	0.6	0.35	0.05
	220/240 V AC	5	3	-	-	-
	250 V DC	-	-	0.3	0.05	0.03
	380/440 V AC	5	2.5	-	-	-
660/690 V AC	5	0.1	-	-	-	

Standards

- Auxiliary indicator contacts comply with IEC 60947-5-1.
- Auxiliary contacts have also been tested according IEC 60 947-5-4.



Auxiliary Switch (OF) / Alarm Switch (SD)

PB119125_L12.eps

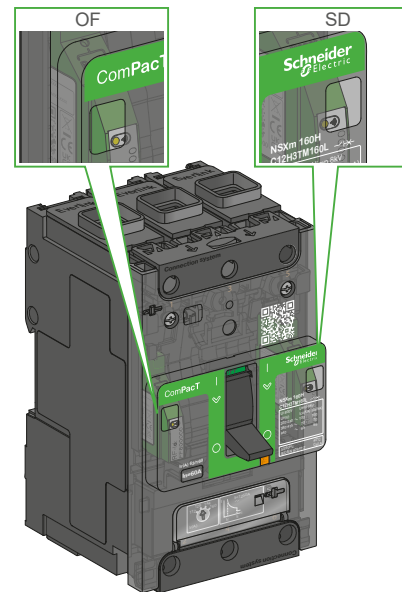

DB438222.ai

ComPacT NSXm Accessories and Auxiliaries

Voltage Release



MX or MN voltage release

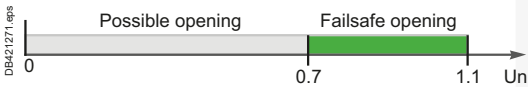

Opening conditions of the MX release

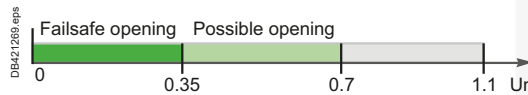

Opening conditions of the MN release



Closing conditions of the MN release

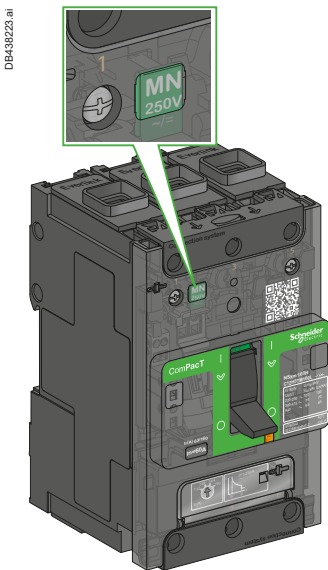

Operating voltages for MN/MX

Shunt Trip (MX) and Undervoltage Release (MN)

A voltage release can be used to trip the circuit breaker using a control signal. They serve primarily for remote, emergency-off commands. It is advised to test the system every six months.

Shunt Trip (MX)

- Trips the circuit breaker when the control voltage rises above 70 % of its rated voltage (U_n).
- Impulse type ≥ 20 ms or maintained control signals.
- Shunt trip 110...130 V AC is suitable for ground-fault protection when combined with a Class I ground-fault sensing element.
- Continuous duty rated coil ^[1].

Undervoltage Release (MN)

- Trips the circuit breaker when the control voltage drops below 35 % of its rated voltage.
- Between 35 % and 70 % of the rated voltage opening is possible but not ensured.
- Above 70 % of the rated voltage, opening does not take place.
- Continuous duty rated coil.
- Circuit breaker closing is possible only if the voltage exceeds 85 % of the rated voltage. If an undervoltage condition exists, operation of the closing mechanism of the circuit breaker will not permit the main contacts to touch, even momentarily. This is commonly called "Kiss Free".

Time-Delay Unit for an Undervoltage Release (MN)

- A time delay unit eliminates the risk of nuisance tripping due to a transient voltage dip lasting less than 200 ms for fixed delay units and up to 3 seconds for adjustable units. For shorter micro-outages, a system of capacitors provides temporary supply to the MN at $U > 0.7 U_n$ to ensure non tripping.

The correspondence between MN and time-delay units is shown below.

Power supply	Corresponding MN
Unit with fixed delay 200 ms	
48 V AC	48 V DC
220/240 V AC	250 V DC
Unit with adjustable delay ≥ 200 ms	
48 - 60 V AC/DC	48 V DC
100 - 130 V AC/DC	125 V DC
220 - 250 V AC/DC	250 V DC

Installation and Connection

- Accessories snap into cavities under the front accessory cover of the circuit breaker. The presence and characteristics of the voltage release is visible from the front face through a window.
- Terminals are spring type in order to ensure a fast and reliable connection.
- Each terminal may be connected by one 0.5...1.5 mm² flexible copper wire.

Operation

- The circuit breaker must be reset locally after being tripped by shunt trip (MX) or undervoltage release (MN).
- Tripping by the shunt trip or undervoltage release has priority over manual closing; in the presence of a standing trip order such an action does not result in any closing, even temporarily, of the main contacts.
- Endurance: 50 % of the rated mechanical endurance of the circuit breaker.

Standard

- MN/MX voltage releases comply with IEC 60947-2.

[1] Except for MX 24 V AC/DC (in case of continuous activation, may generate some minor perturbation in sensitive environment).

Customize Circuit Breakers with Accessories

ComPacT NSXm Accessories and Auxiliaries

SDx Module for MicroLogic Vigi 4.1

SDx Module for ComPacT NSXm MicroLogic Vigi 4.1

The SDx module provides alarming and fault differentiation for the ComPacT NSXm with MicroLogic Vigi 4.1.

This module has 2 NO/NC outputs dry contacts. Each can be assigned with one of the following status:

- Overload alarm (SDT105): current is higher than 105 % of the setting current (I_r).
- Overload trip indication (SDT): circuit breaker has tripped due to an overload fault.
- Earth leakage alarm (SDV80): leakage current is higher than 80 % of the earth leakage trip threshold (I_{Δn}).
- Earth leakage trip indication (SDV): circuit breaker has tripped due to an earth leakage current.

Outputs are automatically reset when the alarm disappears or when the circuit breaker is restarted.

Output Characteristics

- 2 NO/NC dry contacts
- 24...250 V AC/DC
- 2 mA...5 A max
- AC15 (230 V max - 400 VA)
- DC13 (24 V - 50 W)

Power Characteristics

- 24...240 V AC/DC

Front Face Indication



- Green led "On": flashes slowly when the module is powered.
- 2 red led for output status indication.
- 2 setting dials.

Installation and Connection

The SDx module is clipped on the right side on the circuit breaker. Each removable spring terminal can be connected by one 0.5... 1.5 mm² copper wire.

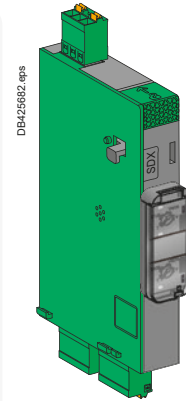

SDx relay module with its terminal block

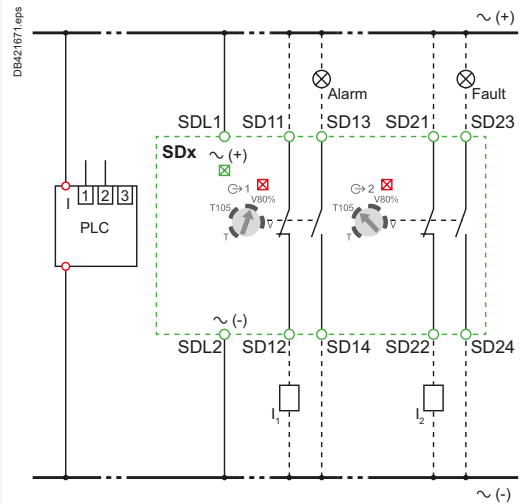

SDx wiring diagram



ComPacT NSXm Accessories and Auxiliaries

Rotary Handles

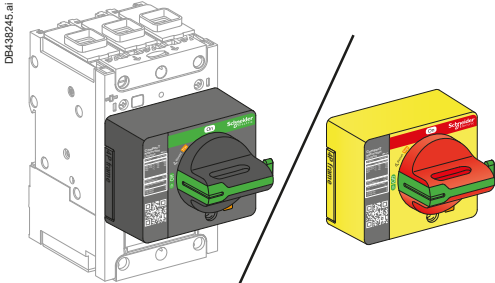

Directly mounted rotary handle

Direct Rotary Handles

Installation

The direct mounted rotary handle has to be mounted by 3 screws on the front accessory cover.

Operation

The direct rotary handle maintains:

- Suitability for isolation
- Indication of the three positions OFF (O), ON (I) and tripped (Trip)
- Access to the "push-to-trip" button
- Visibility and access to the trip unit.

Device padlocking

The circuit breaker may be locked in the OFF position by using one to three padlocks (not supplied) or in ON position after customer modification of the rotary handle before installation, padlock shackle Ø4-8 mm. Locking in the ON position does not prevent the circuit breaker from tripping if a fault occurs. In this case, the handle remains in the ON position after the circuit breaker trips. Unlocking is required for the handle to go to the tripped then the OFF position.

Variations: door locking

Door locking built-in functionality can be activated by the customer to prevent opening the door when the circuit breaker is ON or in trip position. For exceptional situations, door locking can be temporarily disabled with a tool by qualified personnel to open the door when the circuit breaker is closed.

Models

- Standard with black handle.
- VDE type with red handle and yellow bezel for machine tool control.

Extended Rotary Handles

Installation

The door-mounted (extended) rotary handle is made up of:

- A unit that has to be screwed on the front accessory cover of the circuit breaker.
- An assembly (handle mechanism and front plate) on the door that is always secured in the same position, whether the circuit breaker is installed vertically or horizontally
- An adjustable extension shaft.

The handle mechanism is fixed with a nut (Ø22 mm) to make assembly easier. The Laser Square tool (GVAPL01) can be used to accurately align the hole on the door with the circuit breaker.

Operation when door is closed

The door mounted handle makes it possible to operate a circuit breaker installed in an enclosure from the front. The door mounted operating handle maintains:

- Suitability for isolation
- Indication of the three positions OFF (O), ON (I) and tripped (Trip)
- Visibility and access to trip unit when the door is open
- Degree of protection of the handle on the door: IP54 or IP65 as per 60520.

Mechanical door locking when device closed

A standard feature of the extended rotary handle is a locking function, built into the shaft, that disables door opening when the circuit breaker is in the ON or tripped positions.

Door locking can be temporarily disabled with a tool by qualified personnel to open the door without opening the circuit breaker. This operation is not possible if the handle is locked by a padlock.

Device and door padlocking

Padlocking locks the circuit breaker handle and disables door opening:

- Standard situation, in the OFF position, using 1 to 3 padlocks, shackle Ø4-8 mm, padlocks are not supplied
- For the black handle, with a voluntary modification of the door handle (to be done by the customer during installation), in the ON and OFF positions. Locking in the ON position does not prevent the circuit breaker from tripping if a fault occurs. In this case, the handle remains in the ON position after the circuit breaker trips. Unlocking is required for the handle to go to the tripped then the OFF position.

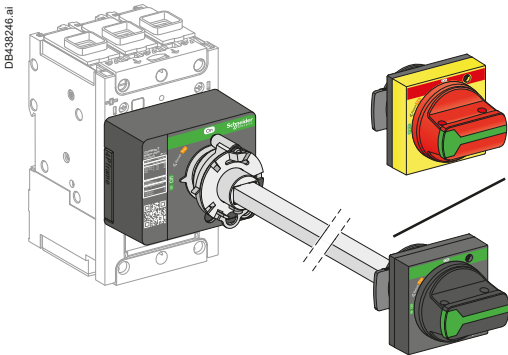

Door-mounted rotary handle

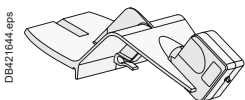

Laser Square tool

Customize Circuit Breakers with Accessories

ComPacT NSXm Accessories and Auxiliaries

Rotary Handles

Operation when door is opened

An open door shaft operator can be used to operate the circuit breaker when door is opened. This accessory complies with UL 508A.

The indication of the three positions OFF (O), ON (I) and tripped (Trip) is visible on the circuit breaker.

The circuit breaker itself may be locked in OFF position when the door is opened by 1 padlock/lockout hasp, shackle Ø4-8 mm.

Shaft length

The shaft length is the distance between the back of the circuit breaker and the door:

- Minimum shaft length is 200 mm
- Maximum shaft length is 600 mm
- Shaft length must be adjusted

Models

- Standard with black handle (IP54)
- VDE type with red handle and yellow bezel for machine tool control (IP54)
- IP65 with red handle and yellow bezel

Side Rotary Handles (Left or Right)

Installation

The side-mounted rotary handle is made up of:

- A unit that has to be screwed on the front accessory cover of the circuit breaker
- An assembly (handle and front plate) on the side (left or right) of the enclosure
- An adjustable extension shaft.

The handle mechanism is fixed with a nut (Ø22 mm) to make assembly easier.

Operation

The side mounted rotary handle makes it possible to operate circuit breakers installed in enclosure from the side. The side mounted rotary handle maintains:

- Suitability for isolation
- Indication of the three positions OFF (O), ON (I) and tripped (Trip). Moreover, the position is visible on the circuit breaker itself
- Visibility and access to trip unit when the door is open
- Degree of protection of the handle on the side: IP54 or IP65 as per 60520.

Device padlocking

The circuit breaker may be locked in the OFF position, or, for the black rotary handle only, in ON position after voluntary modification of the side handle (to be done by the customer during installation), by using one to three padlocks, padlock shackle Ø4-8 mm ; padlocks are not supplied.

Locking in the ON position does not prevent free circuit breaker from tripping if a fault occurs. In this case, the handle remains in the ON position after the circuit breaker tripping. Unlocking is required to go to the tripped then the OFF position.

Shaft length

The shaft length is the distance between the side of the circuit breaker and the side of the enclosure:

- Minimum shaft length is 45 mm
- Maximum shaft length is 480 mm
- Shaft length must be adjusted.

Models

- Standard with black handle (IP54).
- VDE type with red handle and yellow bezel for machine tool control (IP54).
- IP65 with red handle and yellow bezel (by ordering a standard one and an IP65 universal handle).

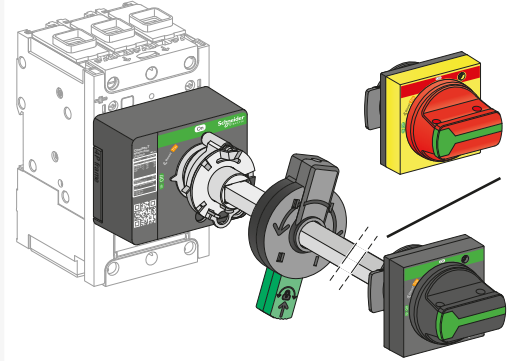

Door-mounted rotary handle with open door shaft operator

DB439247.ai

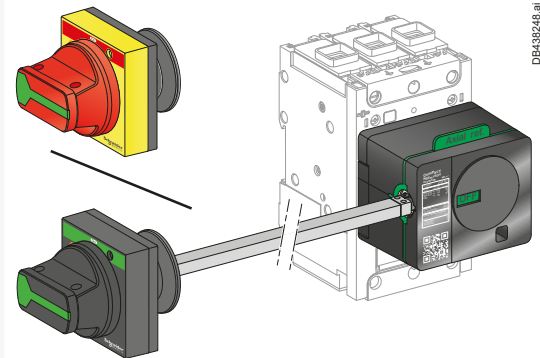

Side mounted rotary handle

DB439248.ai

C

ComPacT NSXm Accessories and Auxiliaries

Locks and Sealing Accessories

Locks

Padlocking systems can receive up to three padlocks with diameters of 5-8 mm ; padlocks not supplied. Locking in the OFF position isolates as per IEC 60947-2.

Control device	Function	Means	Required accessories
Toggle	Lock in OFF position	Padlock	Removable device
	Lock in OFF or ON position	Padlock	Fixed device
	Lock in OFF position	Padlock	Fixed device
Direct rotary handle	Lock in <ul style="list-style-type: none"> ■ OFF position ■ OFF or ON position ^[1] 	Padlock	-
Extended/side rotary handle	Lock in <ul style="list-style-type: none"> ■ OFF position ■ OFF or ON position ^[2] With door opening prevented	Padlock	-

[1] Following a simple modification of the mechanism.

[2] Following a simple modification of the mechanism - black handle only.

Handle Padlocking Device ^[1]

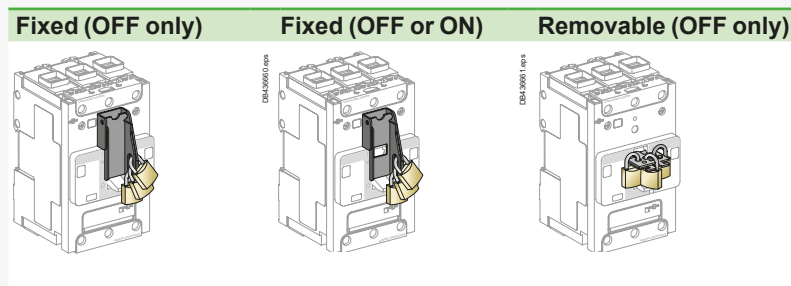

[1] Rotary handle has integrated padlocking capability.



Customize Circuit Breakers with Accessories

ComPacT NSXm Accessories and Auxiliaries

Locks and Sealing Accessories

Sealing Accessories

Sealing accessories are available. Each bag of accessories contains all the parts required for the types of sealing indicated below.

A bag contains:

- 6 sealing accessories
- 6 lead seals.

Types of Seals and Corresponding Functions



LV429335: Bag of sealing accessories

Protected operations			
Control type	<ul style="list-style-type: none"> ■ Front removal ■ Access to auxiliaries. 	<ul style="list-style-type: none"> ■ Access to power connections 	<ul style="list-style-type: none"> ■ Access to settings and test connector
Toggle	<p>DB436862.eps</p>	<p>DB436863.eps</p>	<p>DB436864.eps</p>
Rotary handle	<p>DB421512.eps</p>	<p>DB421513.eps</p>	<p>DB423080.eps</p>



ComPacT NSX Accessories and Auxiliaries

Overview Fixed Version

DB439220.ai

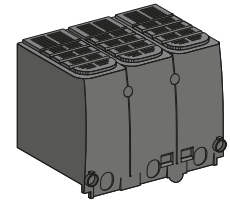

Sealable terminal shields

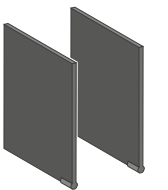
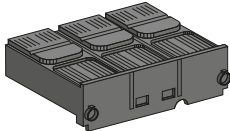

Interphase barriers

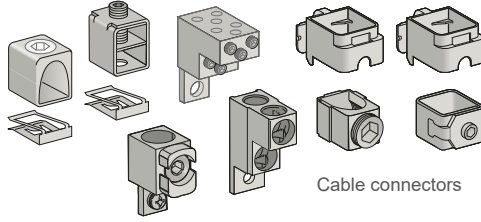

Cable connectors

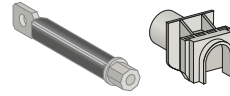

Rear connectors

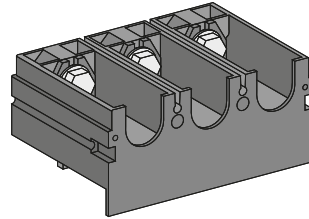

One-piece spreader

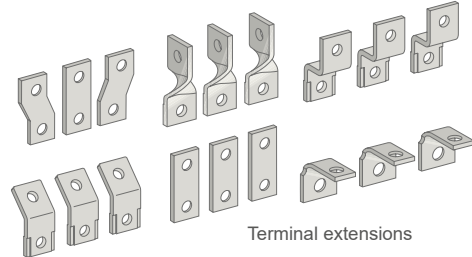

Terminal extensions

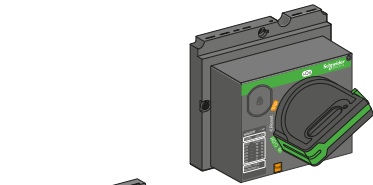
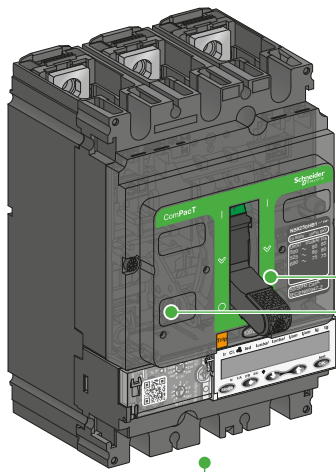

Direct rotary handle

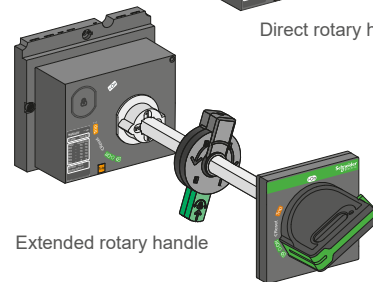

Extended rotary handle

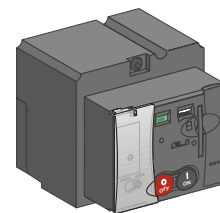

Motor mechanism

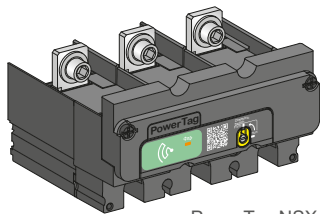

PowerTag NSX

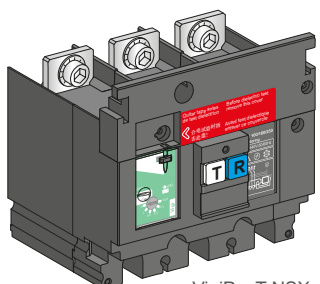

VigiPacT NSX

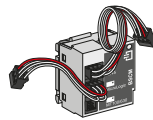

BSCM module

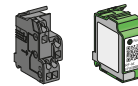

Indication contact



Voltage release

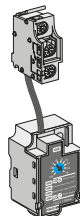

SDTAM module

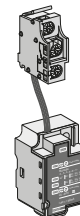

SDx module



NSX cord



ComPacT NSX Accessories and Auxiliaries

Overview Plug-in and Withdrawable Versions

DB438221.ai

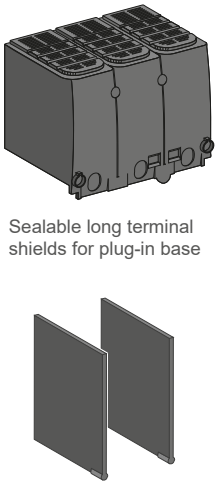

Sealable long terminal shields for plug-in base

Interphase barriers

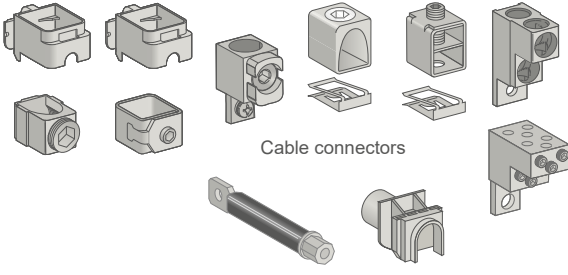

Cable connectors

Rear connectors

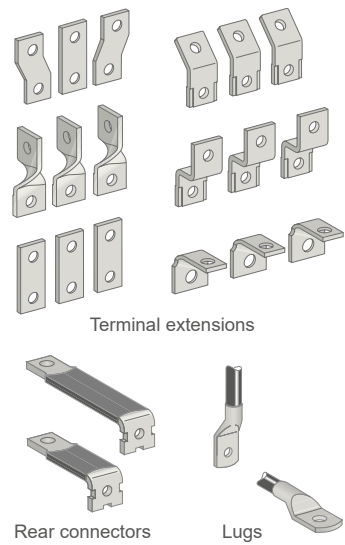

Terminal extensions

Rear connectors

Lugs

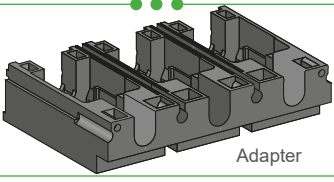

Adapter

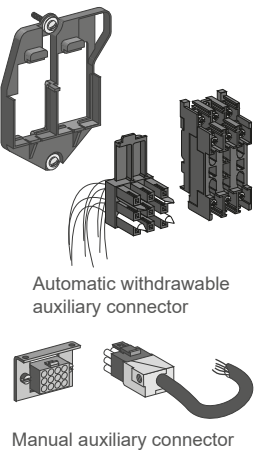

Automatic withdrawable auxiliary connector

Manual auxiliary connector

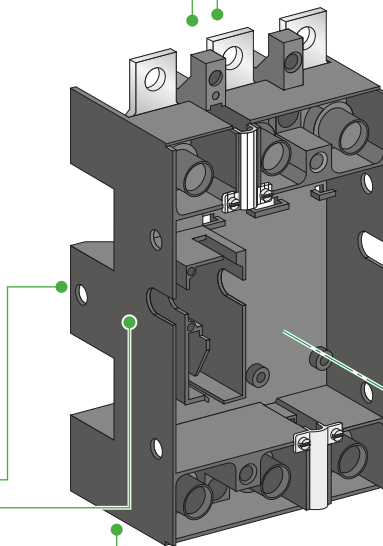
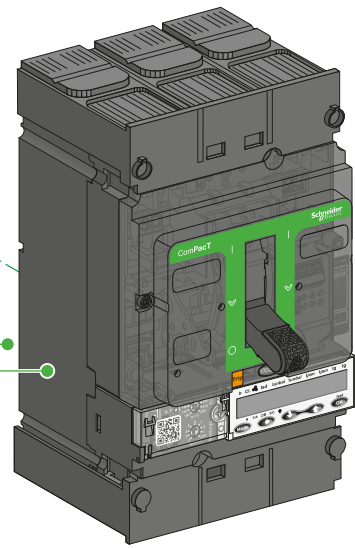
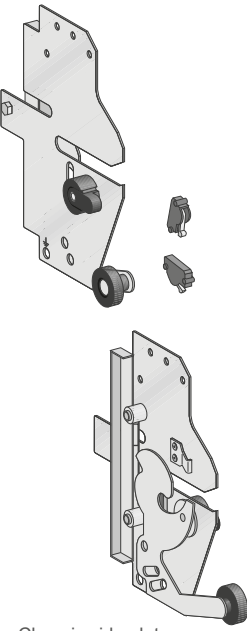
Chassis side plate

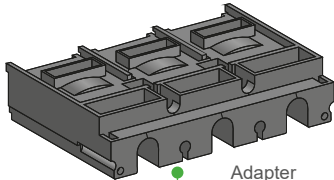

Adapter

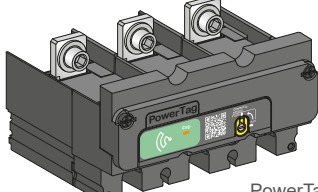

PowerTag NSX

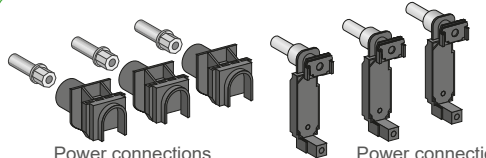

Power connections

Power connections for VigiPacT add-on

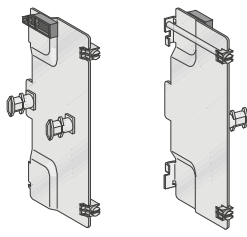

Circuit breaker side plate

[1] For PowerLogic PowerTag NSX 630 A, add a 4 mm intercalary under the module when plate mounted (see page C-43).



ComPacT NSX Accessories and Auxiliaries

Device Installation

Plug-in Circuit Breakers

The plug-in version makes it possible to:

- Extract and/or rapidly replace the circuit breaker without having to touch the connections on the base
- Allow for the addition of future circuits by installing bases that will be equipped with a circuit breaker at a later date
- Isolate the power circuits when the device is mounted on or through a panel. It acts as a barrier for the connections of the plug-in base. Insulation is made complete by the mandatory short terminal shields on the device. The degrees of protection are:
 - circuit breaker plugged in = IP4
 - circuit breaker removed = IP2
 - circuit breaker removed, base equipped with shutters = IP4.

Parts of a plug-in configuration

A plug-in configuration is made by adding a "plug-in kit" to a fixed device. To avoid connecting or disconnecting the power circuits under load conditions, a safety trip causes automatic tripping if the device is ON, before engaging or withdrawing it. The safety trip, supplied with the kit, must be installed on the device. If the device is disconnected, the safety trip does not operate. The device can be operated outside the switchboard.

Accessories

Optional insulation accessories are available.

- Terminal shields to protect against direct contact.
- Interphase barriers to reinforce insulation between phases and to protect against direct contact.

Mounting

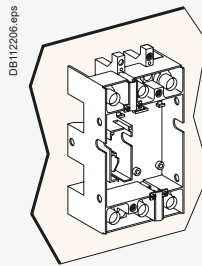

Mounting on a backplate

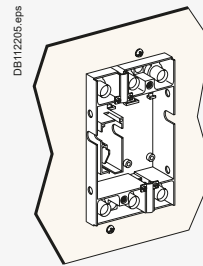

Mounting through a front panel

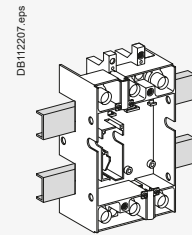

Mounting on rails



Customize Circuit Breakers with Accessories

ComPacT NSX Accessories and Auxiliaries

Device Installation

Withdrawable Circuit Breakers

In addition to the advantages provided by the base, installation on a chassis facilitates handling. It offers three positions, with transfer from one to the other after mechanical unlocking:

- Connected: the power circuits are connected.
- Disconnected: the power circuits are disconnected, the device can be operated to check auxiliary operation.
- Removed: the device is free and can be removed from the chassis.

Parts of a withdrawable configuration

A withdrawable configuration requires two side plates installed on the base and two sides plates mounted on the circuit breaker. Similar to the plug-in version, a safety trip causes automatic tripping if the device is ON, before engaging or withdrawing it, and enables device operation in the disconnected position.

Accessories

Accessories are the same as for the base, with in addition:

- Auxiliary contacts for installation on the fixed part, indicating the "connected" and "disconnected" positions.
- Locking by 1 to 3 padlocks (shackle diameter 5 to 8 mm), to:
 - prevent insertion for connection
 - lock the circuit breaker in connected or disconnected position.
- Toggle collar for circuit breakers with a toggle mounted through a front panel, intended to maintain the degree of protection whatever the position of the circuit breaker (supplied with a toggle extension).
- Telescopic shaft for extended rotary handles. The door can then be closed with the device in the connected and disconnected positions.



Withdrawable ComPacT NSX250

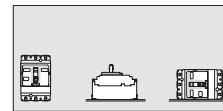

Installation positions

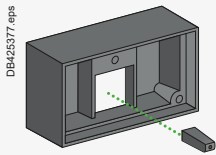
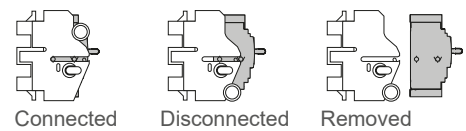

Protection collar for toggle and toggle extension to provide IP4 in the connected and disconnected positions

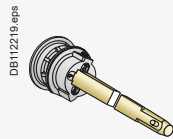

Telescopic shaft

Mounting

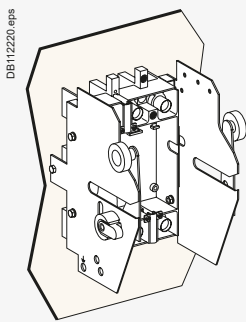

Mounting on a backplate

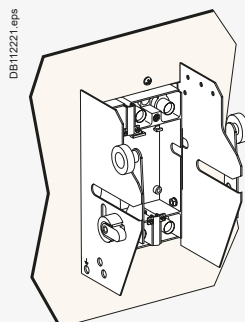

Mounting through a front panel

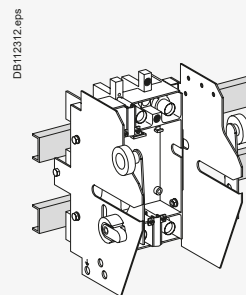

Mounting on rails

PB105122_0.eps

DB438665.eps

DB438666.eps



ComPacT NSX Accessories and Auxiliaries

Connection of Fixed Devices

Fixed circuit breakers are designed for standard front connection using bars or cables with lugs. Cable connectors are available for bare cables. Rear connection is also possible.

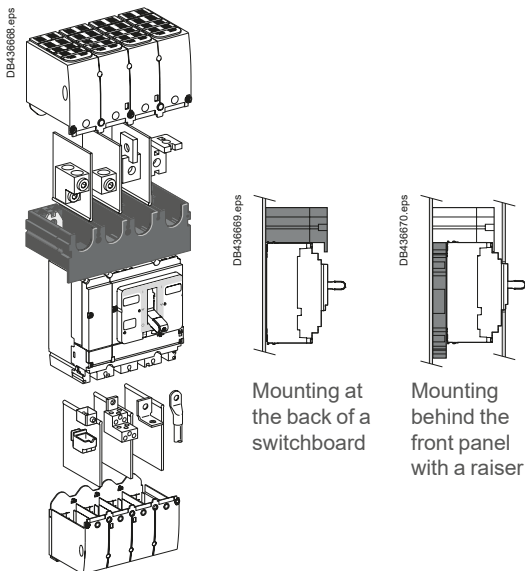
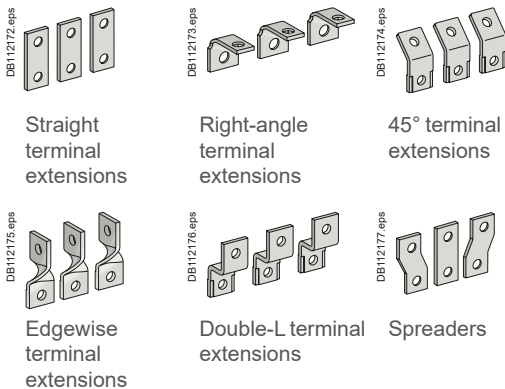
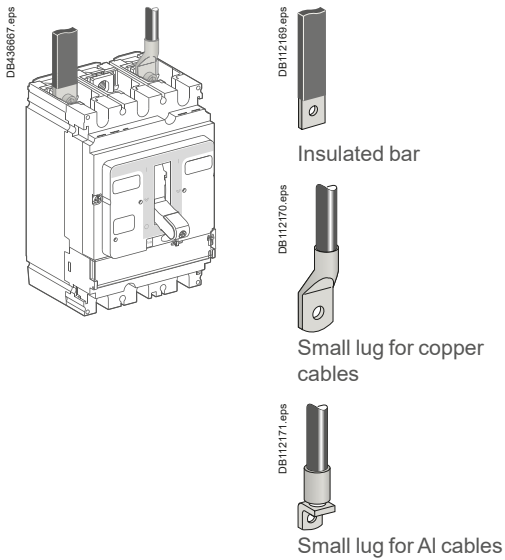

Front Connection

Bars or Cables with Lugs

Standard terminals

ComPacT NSX100 to 630 come with terminals comprising snap-in nuts with screws:

- ComPacT NSX100: M6 nuts and screws. ComPacT NSX160/250: M8 nuts and screws
- ComPacT NSX400/630: M10 nuts and screws.

These terminals may be used for:

- Direct connection of insulated bars or cables with lugs
- Terminal extensions offering a wide range of connection possibilities.

Interphase barriers or terminal shields are recommended. They are mandatory for certain connection accessories (in which case the interphase barriers are provided).

Bars

When non-insulated bars are used, a complete switchboard type test is mandatory to verify the switchboard configuration.

Maximum size of bars

ComPacT NSX circuit breaker		100/160/250	400/630
Without spreaders	pitch (mm)	35	45
	maximum bar size (mm)	20 x 2	32 x 6
With spreaders	pitch (mm)	45	52.5
	maximum bar size (mm)	32 x 2	40 x 10

Crimp lugs

There are two models, for aluminium and copper cables.

It is necessary to use narrow lugs, compatible with device connections. They must be used with interphase barriers or long terminal shields. The lugs are supplied with interphase barriers and may be used for the types of cables listed below.

Cable sizes for connection using lugs

ComPacT NSX circuit breaker		100/160/250	400/630
Copper cables	size (mm ²)	120, 150, 185	240, 300
	crimping	hexagonal barrels or punching	
Aluminium cables	size (mm ²)	120, 150, 185	240, 300
	crimping	hexagonal barrels	

Terminal extensions

Extensions with anti-rotation ribs can be attached to the standard terminals to provide numerous connection possibilities in little space:

- Straight terminal extensions
- Right-angle terminal extensions
- Edgewise terminal extensions
- Double-L extensions
- 45° extensions.

Spreaders

Spreaders may be used to increase the pitch:

- NSX100 to 250: the 35 mm pitch can be increased to 45 mm
- NSX400/630: the 45 mm pitch can be increased to 52 or 70 mm.

Bars, cable lugs or cable connectors can be attached to the ends.

One-piece spreader for NSX100 to 250

Connection of large cables may require an increase in the distance between the device terminals.

The one-piece spreader is the means to:

- Increase the 35 mm pitch of the NSX100 to 250 circuit-breaker terminals to the 45 mm pitch of a NSX400/630 device
- Use all the connection and insulation accessories available for the next largest frame size (lugs, connectors, spreaders, right-angle and edgewise terminal extensions, terminal shields and interphase barriers).

It may also be used for ComPacT INS switch-disconnectors.

Equipped with a single-piece spreader, ComPacT NSX devices can be mounted:

- At the back of a switchboard
- Behind the front panel with a raiser.

The one-piece spreader is also the means to:

- Align devices with different frame sizes in the switchboard
- Use the same mounting plate, whatever the device.

Pitch (mm) depending on the type of spreader

ComPacT NSX circuit breaker	NSX100 to 250	NSX400 to 630
Without spreaders	35	45
With spreaders	45	52.5 or 70
With one-piece spreader	45	-

ComPacT NSX Accessories and Auxiliaries

Connection of Fixed Devices

Bare Cables

For bare cables (without lugs), the prefabricated bare-cable connectors may be used for both copper and aluminium cables.

1-cable connectors for ComPacT NSX100 to 250

The connectors snap directly on to the device terminals or are secured by clips to right-angle and straight terminal extensions as well as spreaders.

1-cable connectors for ComPacT NSX400 to 630

The connectors are screwed directly to the device terminals.

2-cable connectors for ComPacT NSX100 to 250 and 400/630

The connectors are screwed to device terminals or right-angle terminal extensions.

Distribution connectors for ComPacT NSX100 to 250

These connectors are screwed directly to device terminals. Interphase barriers are supplied with distribution connectors, but may be replaced by long terminal shields. Each connector can receive six cables with cross-sectional areas ranging from 1.5 to 35 mm² each.

Lineryg DX and Lineryg DP distribution block for ComPacT NSX100 to 630

Lineryg DX and Lineryg DP connects directly to device terminals.

It is used to connect up to six or nine flexible or rigid cables with cross-sectional areas not exceeding 10 mm² or 16 mm², to each pole.

Connection is made to spring terminals without screws.

Maximum size of cables depending on the type of connector

ComPacT NSX circuit breaker		100/160	250	400	630
Steel connectors	1.5 to 95 mm ²	●			
Aluminium connectors	25 to 95 mm ²	●	●		
	120 to 185 mm ²	●	●		
	120 to 240 mm ²	●	●		
	2 cables 50 to 120 mm ²	●	●		
	2 cables 35 to 240 mm ²			●	●
	35 to 300 mm ²			●	●
Distribution connectors	6 cables 35 mm ²	●	●		
Lineryg DX and Lineryg DP distribution blocks	6 or 9 cables 10/16 mm ²	●	●		

Rear Connection

Device mounting on a backplate with suitable holes enables rear connection.

Bars or Cables with Lugs

Rear connections for bars or cables with lugs are available in two lengths. Bars may be positioned flat, on edge or at 45° angles depending on how the rear connections are positioned.

The rear connections are simply fitted to the device connection terminals. All combinations of rear connection lengths and positions are possible on a given device.

Bare Cables

For the connection of bare cables, the 1-cable connectors for ComPacT NSX100 to 250 may be secured to the rear connections using clips.

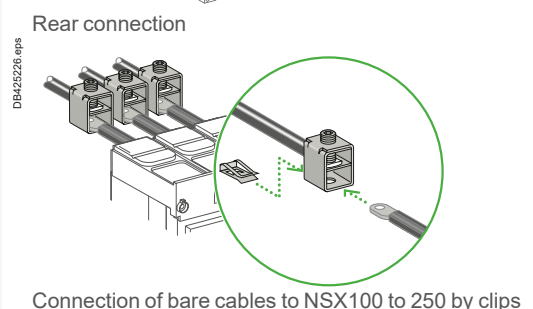
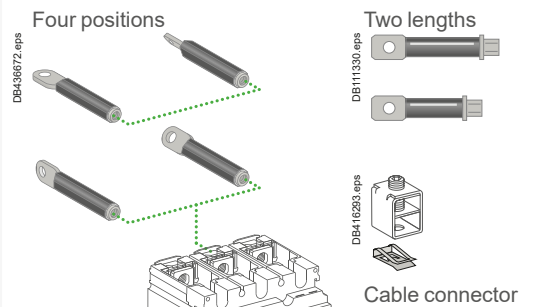
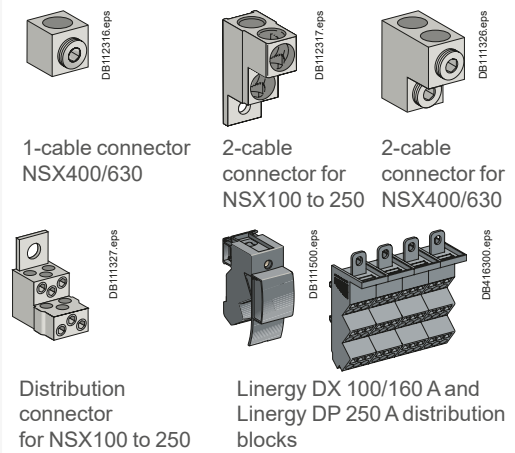
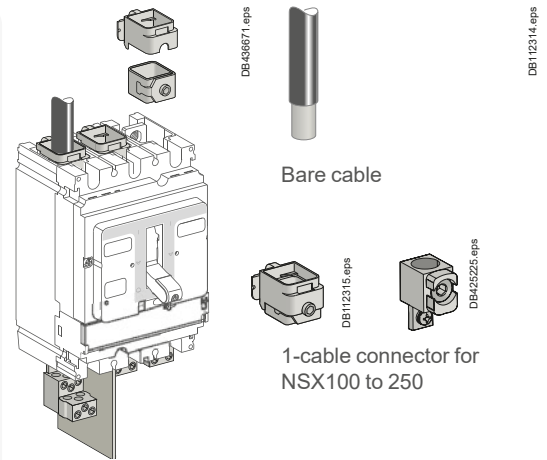

Connection of bare cables to NSX100 to 250 by clips

ComPacT NSX Accessories and Auxiliaries

Connection of Withdrawable and Plug-in Devices

Connection is identical for both withdrawable and plug-in versions. The same accessories as for fixed devices may be used.

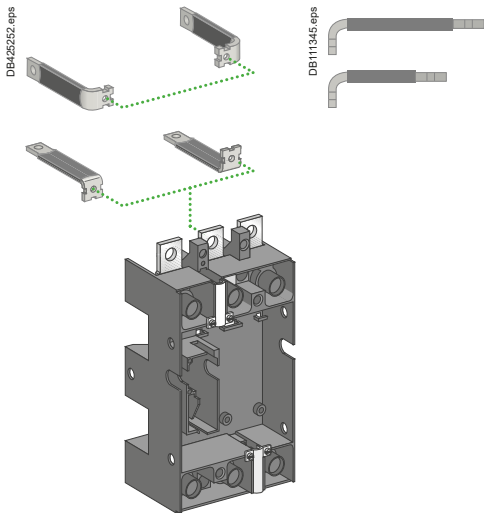

Four positions

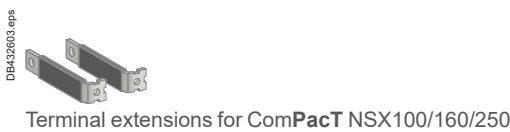

Terminal extensions for ComPacT NSX100/160/250



Terminal extensions for ComPacT NSX400/630

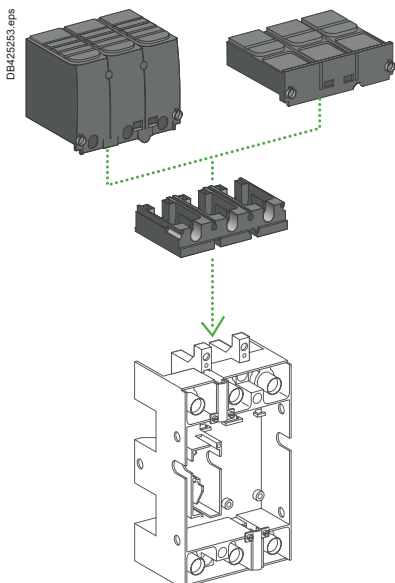

Bars or Cables with Lugs

The plug-in base is equipped with terminals which, depending on their orientation, serve for front and rear connection.

For rear connection of a base mounted on a backplate, the terminals must be replaced by insulated, long right-angle terminal extensions.

For ComPacT NSX630 devices, connection most often requires the 52.5 or 70 mm pitch spreaders.

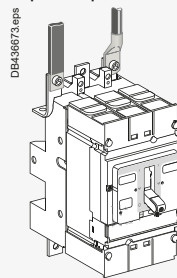

Front connection

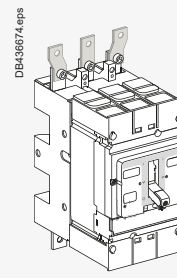

Front connection with spreaders

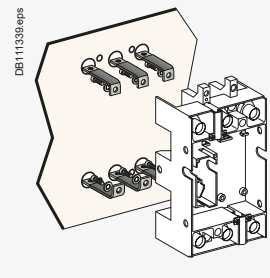

Rear connection of a base mounted on a backplate

Connection accessories

All accessories for fixed devices (bars, lugs, terminal extensions and spreaders) may be used with the plug-in base.

Bare Cables

All terminals may be equipped with bare-cable connectors. See the "Connection of fixed devices" section.

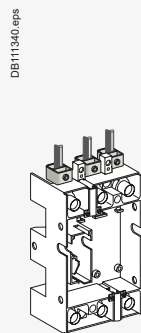

With a 100 to 250 A base

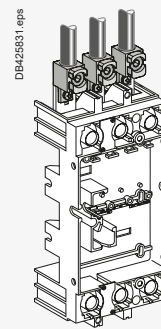

With 240 mm² cable connector for NSX100 to 250

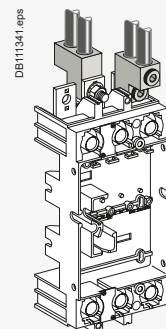

With a 400/630 A base

Adapter for Plug-in Base

The adapter is a plastic component for the 100 to 250 base and the 400/630 base that enables use of all the connection accessories of the fixed device.

It is required for interphase barriers and the long and short terminal shields.

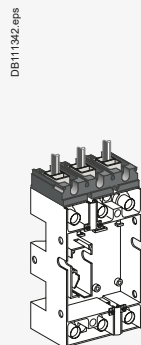

Adapter for 100 to 250 A - 3P base. Connection with bars or cables with lugs

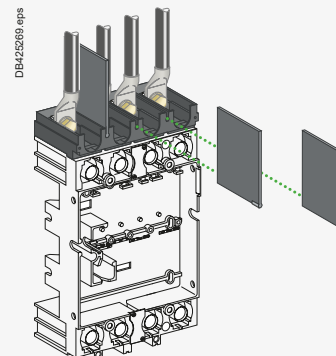

Adapter for 400/630 A - 4P base. Connection with spreaders and interphase barriers

ComPacT NSX Accessories and Auxiliaries

Insulation of Live Parts

Terminal Shields

Insulating accessories used for protection against direct contact with power circuits. They provide IP40 degree of protection and IK07 mechanical impact protection.

Terminal-shield types

ComPacT NSX100 to 250 and NSX400/630 3P or 4P can be equipped with:

- Short terminal shields
- Short terminal shields ≥ 500 V
- Long terminal shields.

All terminal shields have holes or knock-outs in front for voltage-measurement indicators.

Short terminal shields

They are used with:

- Plug-in and withdrawable versions in all connection configurations
- Fixed versions with rear connection.

Long terminal shields

They are used for front connection with cables or insulated bars.

They comprise two parts assembled with captive screws, forming an IP40 cover.

- The top part is equipped with sliding grids with break marks for precise adaptation to cables or insulated bars.
- The rear part completely blocks off the connection zone. Partially cut squares can be removed to adapt to all types of connection for cables with lugs or copper bars. Long terminal shields may be mounted upstream and downstream of:
- Fixed devices
- The base of plug-in and withdrawable versions, thus completing the insulation provided by the mandatory short terminal shields on the device
- The one-piece spreader for NSX100 to 250
- The 52.5 mm spreaders for NSX400/630.

Terminal shields and pitch

Combination possibilities are shown below.

Circuit breaker	NSX100/160/250	NSX400/630	
Short terminal shields			
Pitch (mm)	35	45	
Long terminal shields			
Pitch (mm)	35	45	52.5

Interphase Barriers

Accessories for maximum insulation at the power-connection points:

- They clip easily onto the circuit breaker
- Single version for fixed devices and adapters on plug-in bases
- Not compatible with terminal shields
- The adapter for the plug-in base is required for mounting on plug-in and withdrawable versions.

Rear Insulating Screens

Accessories providing insulation at the rear of the device.

Their use is mandatory for devices with spreaders, installed on backplates, when terminal shields are not used.

The available screen dimensions are shown below.

Circuit breaker	NSX100/160/250	NSX400/630
3P W x H x thickness (mm)	140 x 105 x 1	203 x 175 x 1.5
4P W x H x thickness (mm)	175 x 105 x 1	275 x 175 x 1.5

Terminal shields are identical for fixed and plug-in/withdrawable versions and cover all applications up to 1000 V.

They exist for the 100 to 250 A and 400/630 A ratings, in long and short versions.

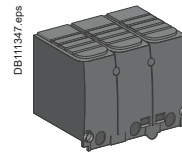

Long terminal shields

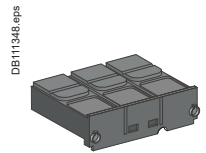

Short terminal shields

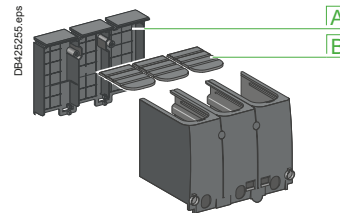

- A** Partially cut removable squares
- B** Grids with break marks

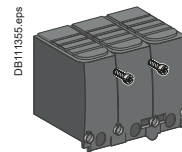

Assembled with captive screws

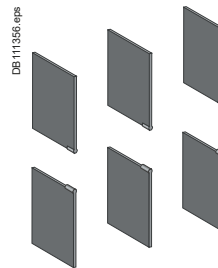

Interphase barriers

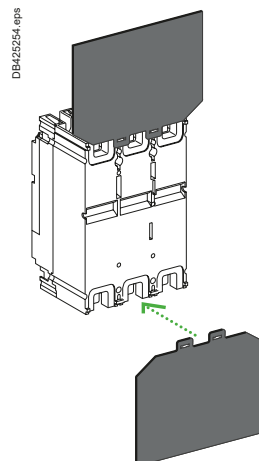

Rear insulating screens



ComPacT NSX Accessories and Auxiliaries

Selection of Auxiliaries

Standard

All ComPacT NSX100/160/250 circuit breakers and switch-disconnectors have slots for the electrical auxiliaries listed below.

5 indication contacts (see page C-30)

- 2 ON/OFF (OF1 and OF2)
- 1 trip indication (SD)
- 1 fault-trip indication (SDE)
- 1 earth-fault indication (SDV), when the device is equipped with a VigiPacT add-on.

1 remote-tripping release (see page C-33)

- Either 1 MN undervoltage release
- Or 1 MX shunt release.

Remote Indications

Circuit breakers equipped with MicroLogic trip units may be equipped with a fault-trip indication to identify the type of fault by installing:

1 indication module with two outputs (see page C-31)

- Either an SDx module with MicroLogic 2.2/4.2/5.2 E/6.2 E or 7 E
 - Or an SDTAM module with MicroLogic 2.2 M or 6-2 E-M (motor protection).
- This module occupies the slots of one OF contact and an MN/MX release.

All these auxiliaries may be installed with a motor mechanism or a rotary handle or a toggle handle.

The following table indicates auxiliary possibilities depending on the type of trip unit.

NA, TMD, TMG, MA

Standard

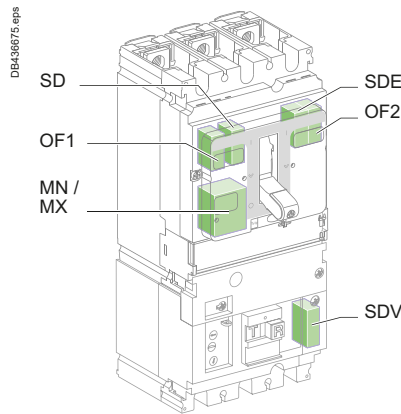
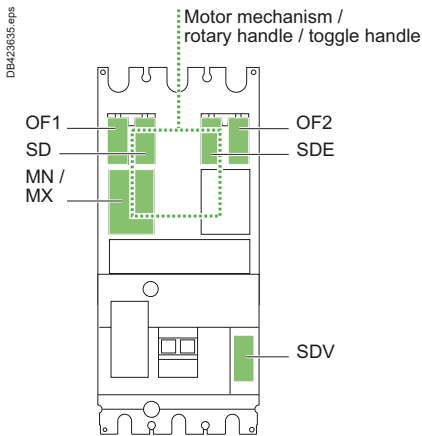

MicroLogic 2/4/5/6/7

Standard

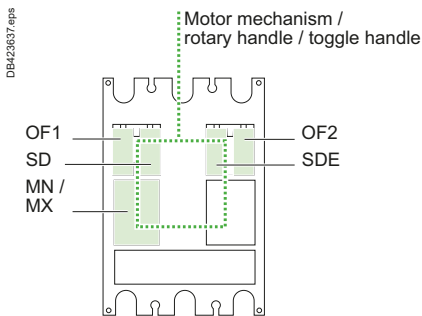

Remote indications via SDx or SDTAM

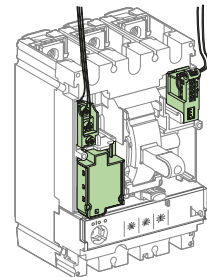
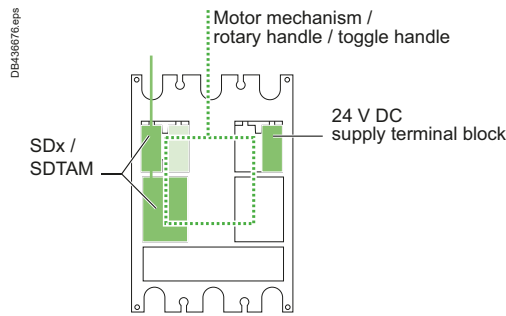

The SDx or SDTAM uses the OF1 and MN/MX slots.

External connection is made via a terminal block in the OF1 slot.

The 24 V DC supply provides for the MicroLogic 5/6/7 display when the device is OFF or under low-load conditions.

Customize Circuit Breakers with Accessories

ComPacT NSX Accessories and Auxiliaries

Selection of Auxiliaries

Communication

Communication requires specific auxiliaries.

Communication of status indications

- 1 BSCM module.
- 1 NSX cord (internal terminal block) for both communication and 24 V DC supply to the BSCM. The insulated NSX cord is mandatory for system voltages greater than 480 V AC.

Communication of status conditions is compatible with a toggle handle and a rotary handle.

Communication of status indications and controls

This requires, in addition to the previous auxiliaries:

- 1 communicating motor mechanism connected to the BSCM.

Communication of measurements

Available on MicroLogic 5/6/7, the system consists of:

- 1 NSX cord (internal terminal block) for both communication and 24 V DC supply to the MicroLogic.

Communication of measurements is compatible with a standard or communicating motor mechanism and a rotary handle.

Communication of status indications, controls and measurements

Available on MicroLogic 5/6/7, the system consists of:

- 1 BSCM module
- 1 NSX cord (internal terminal block) for both communication and 24 V DC supply to the BSCM and the MicroLogic
- 1 communicating motor mechanism connected to the BSCM.

Installation of SDx or SDTAM is compatible with communication.

The following table indicates auxiliary possibilities depending on the type of trip unit.



NA, TMD, TMG, MA, MicroLogic 2/4

Communication of status indications

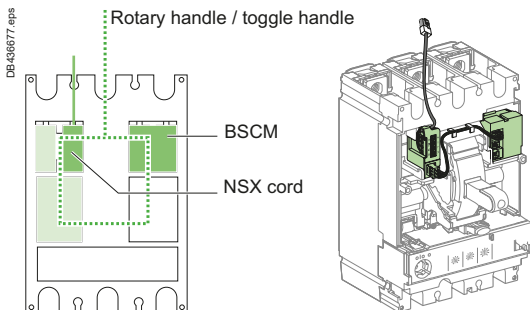

or

Communication of status indications and controls

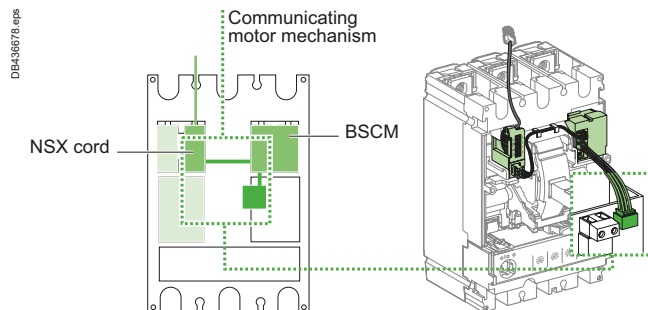

MicroLogic 5/6/7

Communication of measurements with or without FDM121 display

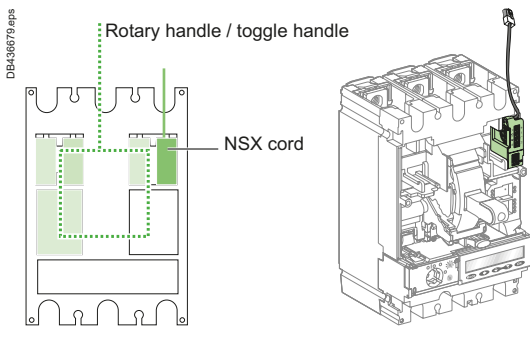

or

Communication of status indications, controls and measurements with or without FDM121 display

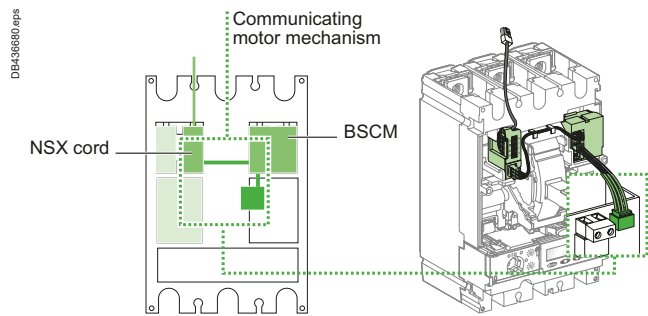

ComPacT NSX Accessories and Auxiliaries

Selection of Auxiliaries

Standard

All ComPacT NSX400/630 circuit breakers and switch-disconnectors have slots for the electrical auxiliaries listed below.

7 indication contacts (see page C-30)

- 4 ON/OFF (OF1, OF2, OF3, OF4)
- 1 trip indication (SD)
- 1 fault-trip indication (SDE)
- 1 earth-fault indication (SDV), when the device is equipped with a VigiPacT add-on.

1 remote-tripping release (see page C-33)

- Either 1 MN undervoltage release
- Or 1 MX shunt release.

Remote Indications

Circuit breakers equipped with MicroLogic trip units may be equipped with a fault-trip indication to identify the type of fault by installing:

1 indication module with two outputs (see page C-31)

- Either an SDx module with MicroLogic 2.3/4.3/5.3 E/6.3 E or 7 E
- Or an SDTAM module with MicroLogic 2.3 M or 6-3 E-M (motor protection).

This module occupies the slots of an MN/MX release.

All these auxiliaries may be installed with a motor mechanism or a rotary handle or a toggle handle.

The following table indicates auxiliary possibilities depending on the type of trip unit.

NA, MicroLogic 1.3 M

Standard

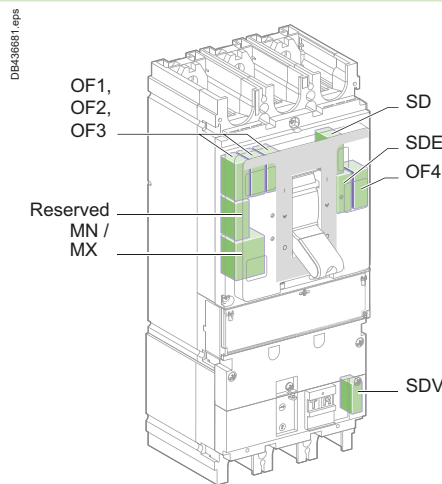
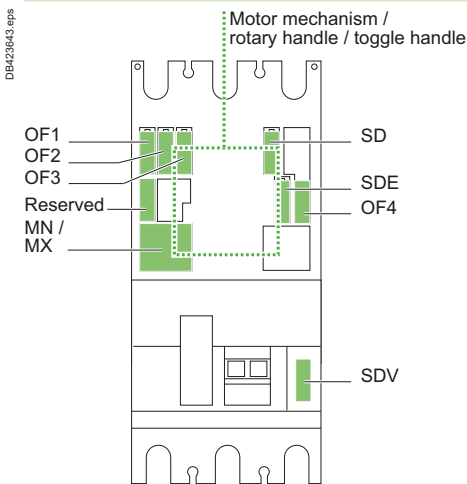

MicroLogic 2/4/5/6/7

Standard

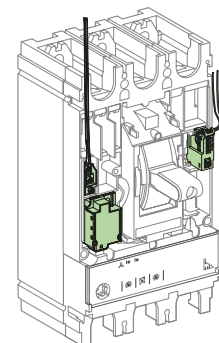
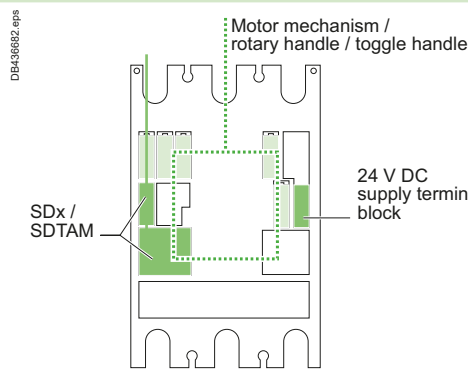
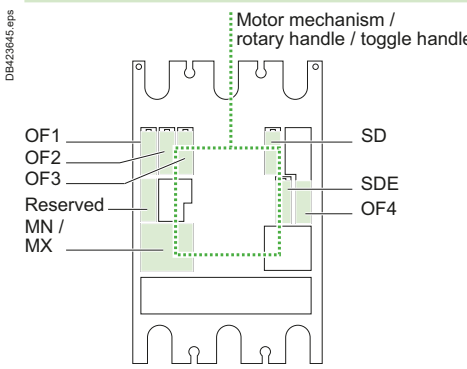

OR

The SDx or SDTAM uses the reserved slot and the MN/MX slots. External connection is made via a terminal block in the reserved slot. The 24 V DC supply provides for the MicroLogic 5/6/7 display when the device is OFF or under low-load conditions.

Customize Circuit Breakers with Accessories

ComPacT NSX Accessories and Auxiliaries

Selection of Auxiliaries

Communication

Communication requires specific auxiliaries.

Communication of status indications

- 1 BSCM module
- 1 NSX cord (internal terminal block) for both communication and 24 V DC supply to the BSCM. The insulated NSX cord is mandatory for system voltages greater than 480 V AC.

Communication of status conditions is compatible with a toggle handle and a rotary handle.

Communication of status indications and controls

This requires, in addition to the previous auxiliaries:

- 1 communicating motor mechanism connected to the BSCM.

Communication of measurements

Available on MicroLogic 5/6/7, the system consists of:

- 1 NSX cord (internal terminal block) for both communication and 24 V DC supply to the MicroLogic.

Communication of measurements is compatible with a standard or communicating motor mechanism and a rotary handle.

Communication of status indications, controls and measurements

Available on MicroLogic 5/6/7, the system consists of:

- 1 BSCM module
- 1 NSX cord (internal terminal block) for both communication and 24 V DC supply to the BSCM and the MicroLogic
- 1 communicating motor mechanism connected to the BSCM.

Installation of SDx or SDTAM is compatible with communication.

The following table indicates auxiliary possibilities depending on the type of trip unit.



NA, MicroLogic 1.3 M, MicroLogic 2/4

Communication of status indications

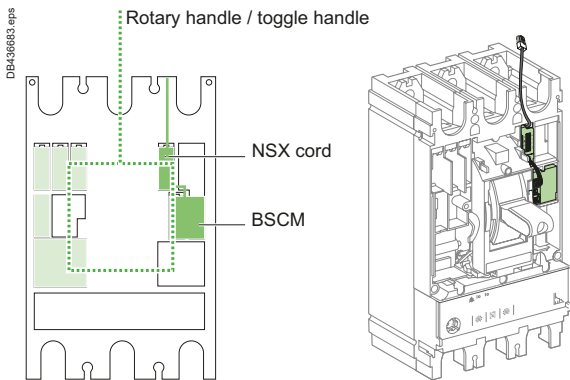

Communication of status indications and controls

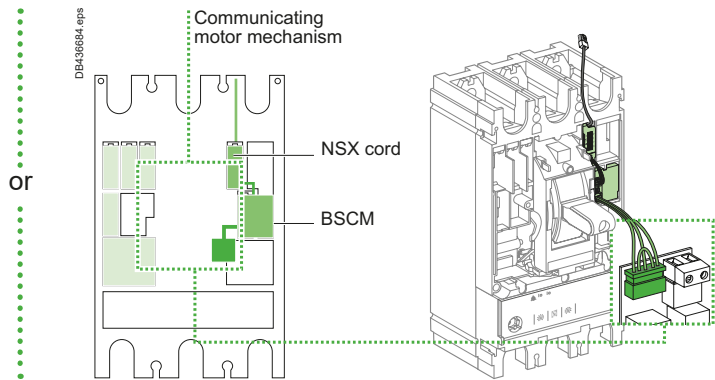

MicroLogic 5/6/7

Communication of status indications

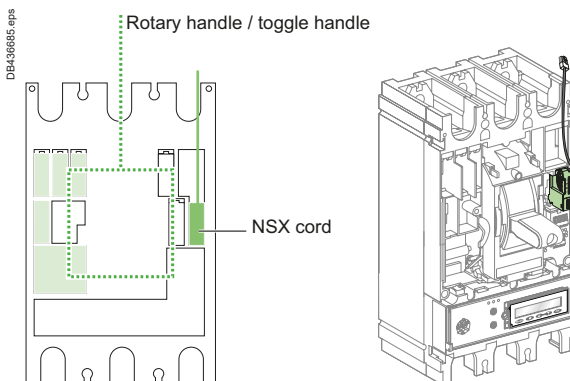

Communication of status indications, controls and measurements with or without FDM121 display

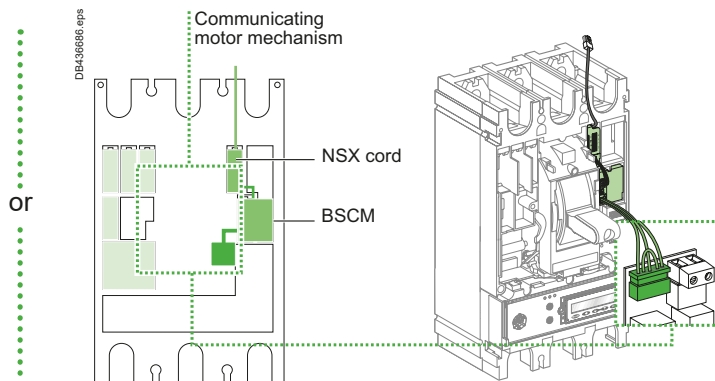

ComPacT NSX Accessories and Auxiliaries

Connection of Electrical Auxiliaries

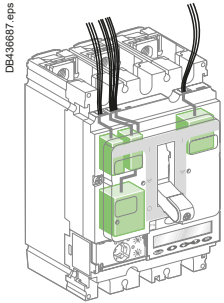

Fixed ComPacT NSX

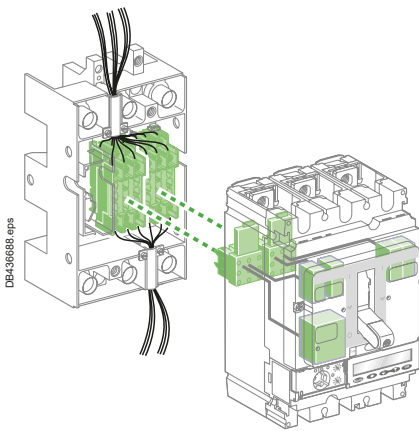

Plug-in/withdrawable ComPacT NSX

Fixed ComPacT NSX

Auxiliary circuits exit the device through a knock-out in the front cover.

Withdrawable or Plug-in ComPacT NSX

Automatic Auxiliary Connectors

Auxiliary circuits exit the circuit breaker via one to three automatic auxiliary connectors (nine wires each). These are made up of:

- A moving part, connected to the circuit breaker via a support (one support per circuit breaker)
- A fixed part, mounted on the plug-in base, equipped with connectors for bare cables up to 2.5 mm².

MicroLogic trip unit options are also wired via the automatic auxiliary connectors.

Selection of automatic auxiliary connectors

Depending on the functions installed, one to three automatic auxiliary connectors are required.

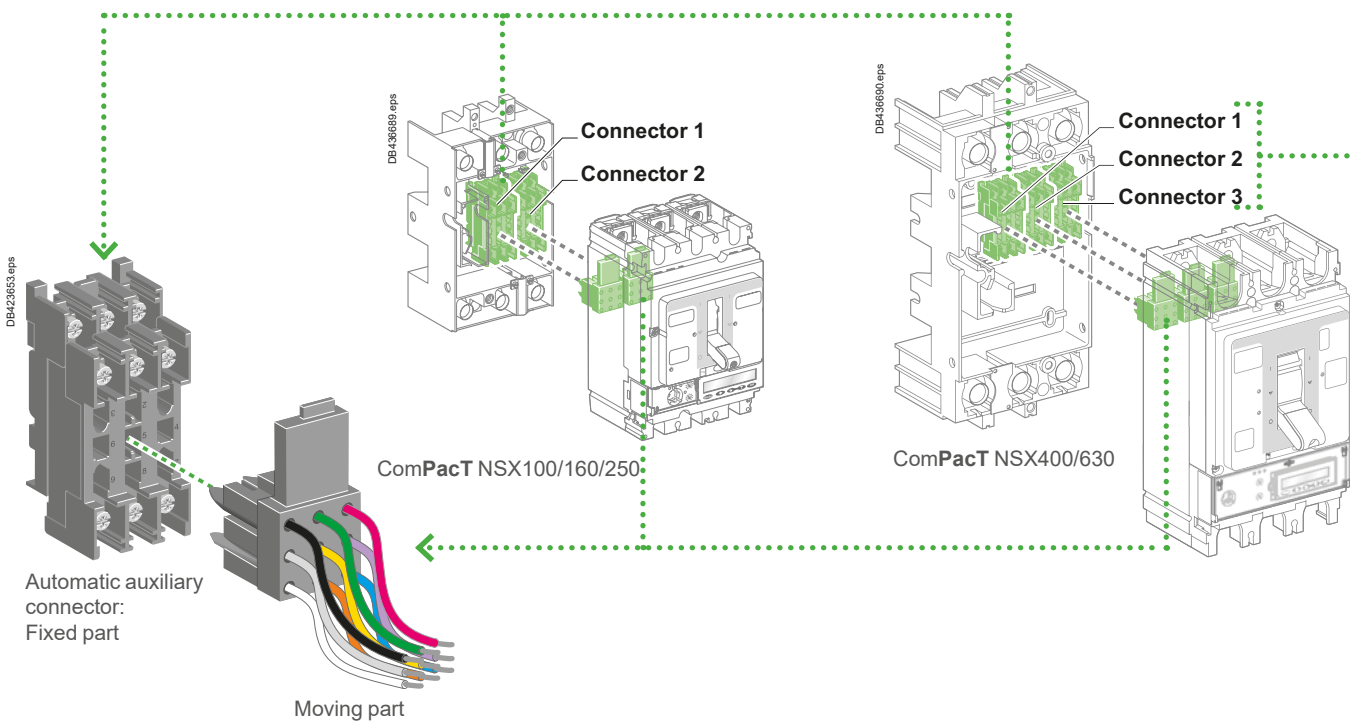

Customize Circuit Breakers with Accessories

ComPacT NSX Accessories and Auxiliaries

Connection of Electrical Auxiliaries

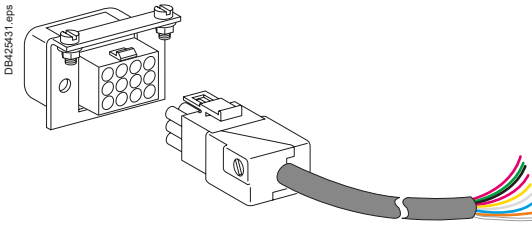

Nine-wire manual auxiliary connector

Withdrawable ComPacT NSX

Manual Auxiliary Connectors

As an option to the automatic auxiliary connectors, withdrawable circuit breakers may be equipped with one to three plugs with nine wires each. In "disconnected" position, the auxiliaries remain connected. They can then be tested by operating the device.

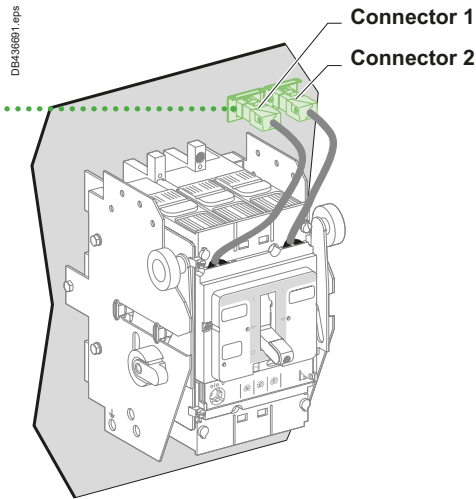

ComPacT NSX100/160/250

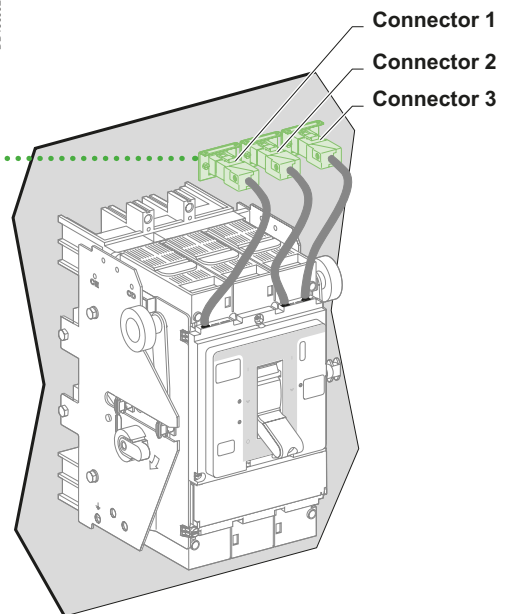

ComPacT NSX400/630

Each auxiliary is equipped with a terminal block with numbered terminals for connection of wires up to:

- 1.5 mm² for auxiliary contacts and voltage releases
- 2.5 mm² for the motor-mechanism module.

Circuit breaker	Connector 1	Connector 2	Connector 3
	OF1 MN/MX or SDx/ SD or SDTAM	OF2/SDV ^[1] /ZSI out ^[1] SDE NSX cord MT MTc 24 V DC	OF3 OF4 ZSI in ZSI out SDV
NSX100/160/250	●	●	-
NSX400/630	●	●	●

[1] Only for NSX100 to 250.

MT: motor mechanism

MTc: communicating motor mechanism



ComPacT NSX Accessories and Auxiliaries

Indication Contacts

One contact model provides circuit-breaker status indications (OF - SD - SDE - SDV).
 An early-make or early-break contact, in conjunction with a rotary handle, can be used to anticipate device opening or closing.
 A CE/CD contact indicates that the chassis is connected/disconnected.



Indication contacts



CE/CD carriage switches

These common-point changeover contacts provide remote circuit-breaker status information.

They can be used for indications, electrical locking, relaying, etc.

They comply with the IEC 60947-5 international standards.

Terminals are spring type in order to ensure a fast and reliable connection.

Functions

Breaker-status indications, during normal operation or after a fault

A single type of contact provides all the different indication functions:

- OF (ON/OFF) indicates the position of the circuit breaker contacts
- SD (trip indication) indicates that the circuit breaker has tripped due to:
 - An overload
 - A short-circuit
 - An earth fault (Vigi) or a ground fault (MicroLogic 6)
 - Operation of a voltage release
 - Operation of the "push to trip" button
 - Disconnection when the device is ON.

The SD contact returns to de-energized state when the circuit breaker is reset.

- SDE (fault-trip indication) indicates that the circuit breaker has tripped due to:
 - An overload
 - A short-circuit
 - An earth fault (Vigi) or a ground fault (MicroLogic 6).

The SD contact returns to de-energized state when the circuit breaker is reset.

- SDV indicates that the circuit breaker has tripped due to an earth fault. It returns to de-energized state when the VigiPacT add-on is reset.

All the above auxiliary contacts are also available in "low-level" versions capable of switching very low loads (e.g. for the control of PLCs or electronic circuits).

Rotary-handle position contact for early-make or early-break functions

- CAM (early-make or early-break function) contacts indicate the position of the rotary handle.

They are used in particular for advanced opening of safety trip devices (early break) or to energize a control device prior to circuit-breaker closing (early make).

Chassis-position contacts

- CE/CD (connected/disconnected) contacts are microswitch-type carriage switches for withdrawable circuit breakers.

Installation

- OF, SD, SDE and SDV functions: a single type of contact provides all these different indication functions, depending on where it is inserted in the device.
 The contacts clip into slots behind the front cover of the circuit breaker (or the VigiPacT add-on for the SDV function).

The SDE function on a ComPacT NSX100-250 A equipped with a magnetic, thermal-magnetic or MicroLogic 2 trip unit requires the SDE actuator.

- CAM function: the contact fits into the rotary-handle unit (direct or extended).
- CE/CD function: the contacts clip into the fixed part of the chassis.

Electrical Characteristics of Auxiliary Contacts

Contacts	Standard					Low level				
	S					OF, SD, SDE, SDV				
Rated thermal current (A)	5					5				
Minimum load	100 mA at 24 V DC					1 mA at 4 V DC				
Utilization cat. (IEC 60947-5-1)	AC12	AC15	DC12	DC13	DC14	AC12	AC15	DC12	DC14	
Operational current (A)	24 V AC/DC	5	5	5	2.5	1	5	3	5	1
	48 V AC/DC	5	5	2.5	1.2	0.2	5	3	2.5	0.2
	110 V AC/DC	5	5	0.6	0.35	0.05	5	2.5	0.6	0.05
	220/240 V AC	5	4	-	-	-	5	2	-	-
	250 V DC	-	-	0.3	0.03	0.03	5	-	0.3	0.03
	380/440 V AC	5	2	-	-	-	5	1.5	-	-
	480 V AC	5	1.5	-	-	-	5	1	-	-
660/690 V AC	5	0.1	-	-	-	-	-	-	-	

Customize Circuit Breakers with Accessories

ComPacT NSX Accessories and Auxiliaries

SDx and SDTAM

SDx Module

The SDx module remotes the trip or alarm conditions of ComPacT NSX circuit breakers equipped with electronic protection. The SD2 output, available on all MicroLogic trip units, corresponds to the overload-trip indication.

The SD4 output, available on MicroLogic 5/6/7, is assigned to:

- MicroLogic 5: overload (Ir)
- MicroLogic 6: overload (Ir) and ground fault (Ig)
- MicroLogic Vigi 7E: overload (Ir) and earth leakage fault (IΔn).

These two outputs automatically reset when the device is closed (turned ON).

For MicroLogic 5/6/7, the SD2 and SD4 outputs can be reprogrammed to be assigned to other types of tripping or alarm.

Output characteristics

It is possible to assign a function:

- Latching with a time delay. Return to the initial state occurs at the end of the time delay
- Permanent latching. In this case, return to the initial state takes place via the communication function.

Static outputs: 24 to 415 V AC/V DC; 80 mA max.

SDTAM Module

The SDTAM module is specifically for the motor-protection MicroLogic trip units 2.2 M, 2.3 M and 6.2 E-M, 6.3 E-M.

The SDTAM module, linked to the contactor controller, opens the contactor when an overload or other motor fault occurs, thus avoiding opening of the circuit breaker.

MicroLogic 2 M

The SD4 output opens the contactor 400 ms before normal circuit-breaker opening in the following cases:

- Overload (long-time protection for the trip class)
- Phase unbalance or phase loss.

The SD2 output serves to memorize contactor opening by SDTAM.

MicroLogic 6 E-M

The SD4 output opens the contactor 400 ms before normal circuit-breaker opening in the following cases:

- Overload (long-time protection for the trip class)
- Phase unbalance or phase loss
- Locked rotor
- Underload (undercurrent protection)
- Long start.

The SD2 output serves to memorize contactor opening by SDTAM.

Output characteristics

Output reset can be:

- Manual by a pushbutton included in the wiring diagram
- Automatic after an adjustable time delay (1 to 15 minutes) to take into account the motor-cooling time.

Static outputs: 24 to 415 V AC/V DC; 80 mA max.

SDx and SDTAM are relay modules with two static outputs. They send different signals depending on the type of fault. They may not be used together.



SDx relay module with its terminal block

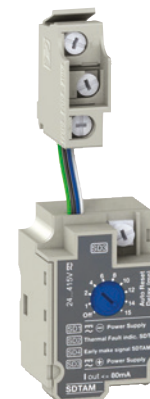

SDTAM relay module with its terminal block

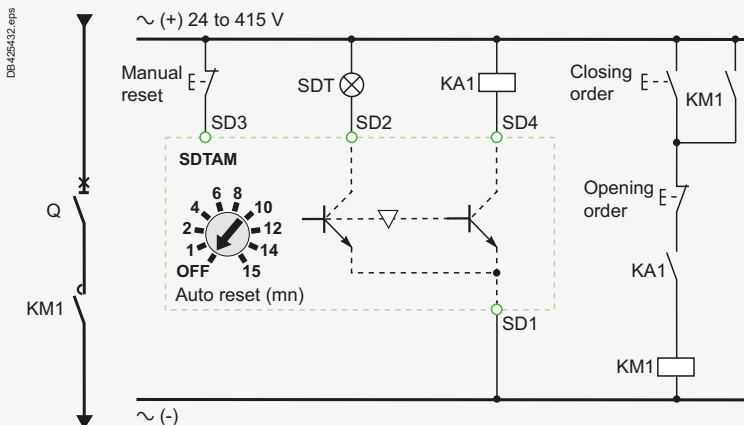

SDTAM wiring diagram with contactor control

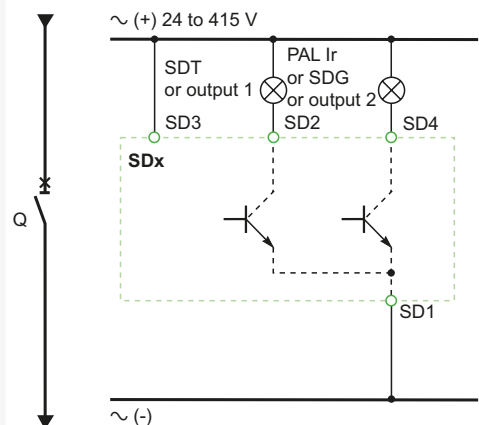

SDx wiring diagram

ComPacT NSX Accessories and Auxiliaries

Motor Mechanism



ComPacT NSX250 with motor mechanism

When equipped with a **motor-mechanism** module, ComPacT NSX circuit breakers feature very high mechanical endurance as well as easy and reliable operation:

- All circuit-breaker indications and information remain visible and accessible, including trip-unit settings and indications.
- Suitability for isolation is maintained and padlocking remains possible.
- Double insulation of the front face.

A specific motor mechanism is required for operation via the communication function. This **communicating motor mechanism** must be connected to the BSCM module to receive the opening and closing orders. Operation is identical to that of a standard motor mechanism.

Applications

- Local motor-driven operation, Centralized operation, automatic distribution control.
- Normal/standby source changeover or switching to a replacement source for availability and energy cost optimization.
- Load shedding and reconnection.
- Synchrocoupling.

Operation

The type of operation is selected using the manual/auto mode selection switch (7). A transparent, lead-seal cover controls access to the switch.

Automatic

When the switch is in the "auto" position, the ON/OFF (I/O) buttons and the charging lever on the mechanism are locked.

- Circuit-breaker ON and OFF controlled by two impulse-type or maintained signals.
- Automatic spring charging following voluntary tripping (by MN or MX), with standard wiring.
- Mandatory manual reset following tripping due to an electrical fault.

Manual

When the switch is in the "manual" position, the ON/OFF (I/O) buttons may be used. A microswitch linked to the manual position can remote the information.

- Circuit-breaker ON and OFF controlled by 2 pushbuttons I/O.
- Recharging of stored-energy system by pumping the lever 8 times.
- Padlocking in OFF position.

Installation and Connections

All installation (fixed, plug-in/withdrawable) and connection possibilities are maintained.

Motor-mechanism module connections are made behind its front cover to integrated terminals, for cables up to 2.5 mm².

Optional Accessories

- Keylock for locking in OFF position.
- Operations counter for the ComPacT NSX400/630, indicating the number of ON/OFF cycles. Must be installed on the front of the motor-mechanism module.

Characteristics

Motor mechanism		MT100 to MT630	
Response time (ms)	opening	< 700	
	closing	< 80	
Operating frequency	cycles/minute max.	4	
Control voltage (V)	DC	24/30 - 48/60 - 110/130 - 250	
	AC 50/60 Hz	48 (50 Hz) - 110/130 - 220/240 - 380/440	
Consumption ⁽¹⁾	DC (W)	opening	≤ 500
		closing	≤ 500
	AC (VA)	opening	≤ 500
		closing	≤ 500

[1] For NSX100 to NSX250, the inrush current is 2 In for 10 ms.

Electrical Endurance

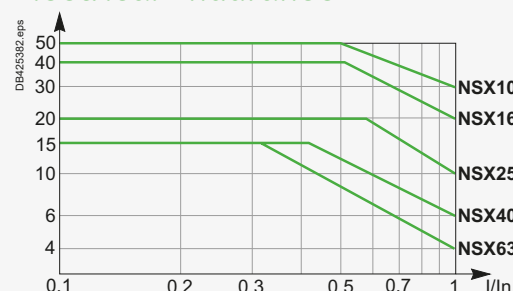

Circuit breaker + motor-mechanism module, in thousands of operations, at 440 V

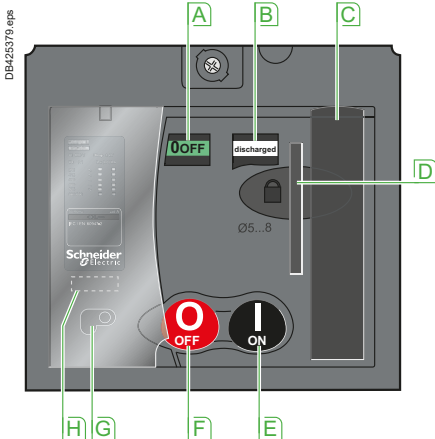

- A** Position indicator (positive contact indication)
- B** Spring status indicator (charged, discharged)
- C** Manual spring-charging lever
- D** Keylock device (optional)
Locking device (OFF position), using 1 to 3 padlocks, shackle diameter 5 to 8 mm, not supplied
- E** I (ON) pushbutton
- F** O (OFF) pushbutton
- G** Manual/auto mode selection switch The position of this switch can be indicated remotely
- H** Operation counter (ComPacT NSX400/630)

Customize Circuit Breakers with Accessories

ComPacT NSX Accessories and Auxiliaries

Remote Tripping

MX or MN voltage releases are used to trip the circuit breaker. They serve primarily for remote, emergency-off commands. It is advised to test the system every six months. Terminals are spring type in order to ensure a fast and reliable connection.

MN Undervoltage Release

The MN release opens the circuit breaker when its supply voltage drops to a value below 35 % of its rated voltage U_n .

Undervoltage tripping, combined with an emergency-off button, provides fail-safe tripping. The MN release is continuously supplied, i.e. if supply is interrupted:

- Either voluntarily, by the emergency-off button
- Or accidentally, through loss of power or faulty wiring.

The release provokes opening of the circuit breaker.

Opening conditions

Circuit-breaker tripping by an MN release meets the requirements of standard IEC 60947-2.

- Automatic opening of the circuit breaker is ensured when the continuous voltage supply to the release $U \leq 0.35 \times U_n$.
- If the supply voltage is between 0.35 and 0.7 U_n , opening is possible, but not guaranteed. Above 0.7 U_n , opening does not take place.

Closing conditions

If there is no supply to the MN release, it is impossible to close the circuit breaker, either manually or electrically. Closing is ensured when the voltage supply to the release $U \geq 0.85 \times U_n$. Below this threshold, closing is not ensured.

Characteristics

Power supply	V AC	50/60 Hz: 24 - 48 - 100/130 - 200/240 50 Hz: 380/415 60 Hz: 208/277
	V DC	12 - 24 - 30 - 48 - 60 - 125 -250
Operating threshold	Opening	0.35 to 0.7 U_n
	Closing	0.85 U_n
Operating range		0.85 to 1.1 U_n
Consumption (VA or W)		Pick-up: 10 - Hold: 5
Response time (ms)		50

Time-delay unit for an MN release

A time delay unit for the MN release eliminates the risk of nuisance tripping due to a transient voltage dip. For shorter micro-outages, a system of capacitors provides temporary supply to the MN at $U > 0.7$ to ensure non tripping. The correspondence between MN releases and time-delay units is shown below.

Power supply	Corresponding MN release
Unit with fixed delay 200 ms	
48 V AC	48 V DC
220/240 V AC	250 V DC
Unit with adjustable delay ≥ 200 ms	
48 - 60 V AC/DC	48 V DC
100 - 130 V AC/DC	125 V DC
220 - 250 V AC/DC	250 V DC

MX Shunt Release

The MX release opens the circuit breaker via an impulse-type (≥ 20 ms) or maintained order.

Opening conditions

When the MX release is supplied, it automatically opens the circuit breaker. Opening is ensured for a voltage $U \geq 0.7 \times U_n$.

Characteristics

Power supply	V AC	50/60 Hz: 24 - 48 - 100/130 - 200/240 50 Hz: 380/415 60 Hz: 208/277
	V DC	12 - 24 - 30 - 48 - 60 - 125 -250
Operating range		0.7 to 1.1 U_n
Consumption (VA or W)		Pick-up: 10
Response time (ms)		50

Circuit Breaker Control by MN or MX

When the circuit breaker has been tripped by an MN or MX release, it must be reset before it can be reclosed.

MN or MX tripping takes priority over manual closing.

In the presence of a standing trip order, closing of the contacts, even temporary, is not possible.

Connection using wires up to 1.5 mm² to integrated terminal blocks with screwless connections.



MX or MN voltage release

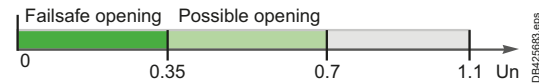

Opening conditions of the MN release



Closing conditions of the MN release

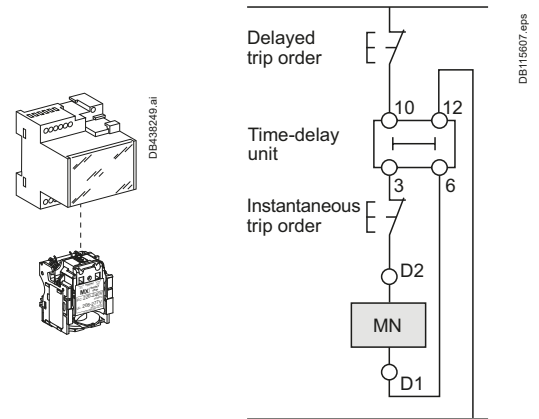

MN release with a time-delay unit

Wiring diagram for emergency-off function with MN + time-delay unit

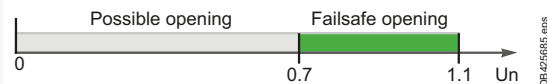

Opening conditions of the MX release

Note: Circuit breaker opening using an MN or MX release must be reserved for safety functions. This type of tripping increases wear on the opening mechanism. Repeated use reduces the mechanical endurance of the circuit breaker by 50 %.

ComPacT NSX Accessories and Auxiliaries

Rotary Handles

There are two types of rotary handle:

- Direct rotary handle
- Extended rotary handle.

There are two models:

- Standard with a black handle
- Red handle and yellow front for machine-tool control.



PB105116-Q.eps

ComPacT NSX with a rotary handle



PB103807-50-Q.eps

ComPacT NSX with an MCC rotary handle



PB103808-50-Q.eps

ComPacT NSX with a CNOMO machine-tool rotary handle



PB105117-Q.eps

ComPacT NSX with an extended rotary handle installed at the back of a switchboard, with the keylock option and key

Direct Rotary Handle

Standard Handle

Degree of protection IP40, IK07.

The direct rotary handle maintains:

- Visibility of and access to trip-unit settings
- Suitability for isolation
- Indication of the three positions O (OFF), I (ON) and tripped
- Access to the "push to trip" button.

Device locking

The rotary handle facilitates circuit-breaker locking.

- Padlocking:
 - Standard situation, in the OFF position, using 1 to 3 padlocks, shackle diameter 5 to 8 mm, not supplied.
 - With a simple modification, in the ON and OFF positions. Locking in the ON position does not prevent free circuit-breaker from tripping if a fault occurs. In this case, the handle remains the ON position after the circuit breaker tripping. Unlocking is required to go to the tripped then the OFF position.
- Keylock (and padlock).

It is possible to install a Ronis or Profalux keylock (optional) on the base of the handle to obtain the same functions as with a padlock.

Early-make or early-break contacts (optional)

Early-make and/or early-break contacts may be used with the rotary handle. It is thus possible to:

- Supply an MN undervoltage release before the circuit breaker closes
- Open the contactor control circuit before the circuit breaker opens.

MCC Switchboard Control

Control of an MCC switchboard is achieved by adding a kit to the standard handle. In addition to the standard functions, the kit offers the characteristics listed below.

Higher degree of protection IP

Degree of protection IP43, IK07.

The IP is increased by a built-in gasket.

Door locking depending on device position

- The door cannot be opened if the circuit breaker is ON or in the tripped position. For exceptional situations, door locking can be temporarily disabled with a tool to open the door when the circuit breaker is closed.
- Circuit-breaker closing is disabled if the door is open. This function can be deactivated.

Machine-Tool Control in Compliance with CNOMO

Control of a machine-tool is achieved by adding a kit to the standard handle. In addition to the standard functions, the kit offers the characteristics listed below.

Enhanced waterproofness and mechanical protection

- Degree of protection IP54, IK08.
- Compliance with CNOMO E03.81.501N.

Extended Rotary Handle

Degree of protection IP55, IK08.

The extended rotary handle makes it possible to operate circuit breakers installed at the back of switchboards, from the switchboard front.

It maintains:

- Visibility of and access to trip-unit settings
- Suitability for isolation
- Indication of the three positions O (OFF), I (ON) and tripped.

Mechanical door locking when device closed

A standard feature of the extended rotary handle is a locking function, built into the shaft, that disables door opening when the circuit breaker is in the ON or tripped positions.

Door locking can be temporarily disabled with a tool to open the door without opening the circuit breaker. This operation is not possible if the handle is locked by a padlock.

Voluntary disabling of mechanical door locking

A modification to the handle, that can be carried out on site, completely disables door locking, including when a padlock is installed on the handle. The modification is reversible.

When a number of extended rotary handles are installed on a door, this disabling function is the means to ensure door locking by a single device.

Customize Circuit Breakers with Accessories

ComPacT NSX Accessories and Auxiliaries

Rotary Handles

Extended Rotary Handle (Cont.)

Operation when door is opened

An open door shaft operator can be used to operate the circuit breaker when door is opened. This accessory complies with UL508.

The indication of the three positions OFF (O), ON (I) and tripped (Trip) is visible on the circuit breaker.

Device and door padlocking

Padlocking locks the circuit-breaker handle and disables door opening:

- Standard situation, in the OFF position, using 1 to 3 padlocks, shackle diameter 5 to 8 mm, not supplied.
- With a simple modification, in the ON and OFF positions. Locking in the ON position does not prevent free circuit-breaker tripping if a fault occurs.

In this case, the handle remains in the ON position after the circuit breaker tripping.

Unlocking is required to go to the tripped then the OFF position.

If the door controls were modified to voluntarily disable door locking, padlocking does not lock the door, but does disable handle operation of the device.

Device locking using a keylock inside the switchboard

It is possible to install a Ronis or Profalux keylock (optional) on the base of the rotary handle to lock the device in the OFF position or in either the ON or OFF positions.

Accessory for device operation with the door open

When the device is equipped with an extended rotary handle, a control accessory mounted on the shaft makes it possible to operate the device with the door open.

- The device can be padlocked in the OFF position.
- The accessory complies with UL508.

Early-make or early-break contacts (optional)

The extended rotary handle offers the same possibilities with early-make and/or early-break contacts as the standard rotary handle.

Parts of the extended rotary handles

- A unit that replaces the front cover of the circuit breaker (secured by screws).
- An assembly (handle and front plate) on the door that is always secured in the same position, whether the circuit breaker is installed vertically or horizontally.
- An extension shaft that must be adjusted to the distance. The min/max distance between the back of circuit breaker and door is:
 - 185...600 mm for ComPacT NSX100 to 250
 - 209...600 mm for ComPacT NSX400/630.

For withdrawable devices, the extended rotary handle is also available with a telescopic shaft to compensate for device disconnection. In this case, the min/max distances are:

- 248...600 mm for ComPacT NSX100 to 250
- 272...600 mm for ComPacT NSX400/630.

Manual Source-Changeover Systems

An additional accessory interlocks two devices with rotary handles to create a source-changeover system. Closing of one device is possible only if the second is open.

This function is compatible with direct or extended rotary handles.

Up to three padlocks can be used to lock in the OFF or ON position.



PB105127-Q.eps

C

ComPacT NSX Accessories and Auxiliaries

Manual and Automatic Transfer Switch

Schneider Electric offers source change-over systems based on ComPacT and MasterPacT devices. They are made of up to 3 circuit breakers or switch-disconnectors linked by an electrical interlocking system that may have different configurations. Moreover, a mechanical interlocking system must be added to protect against electrical malfunctions or incorrect manual operations. In addition, a controller can be used for automatically control the source transfer. The following pages present the different solutions for mechanical and electrical interlocking and associated controllers.

M

Manual source-changeover system (or MTSE: Manual Transfer Switching Equipment)

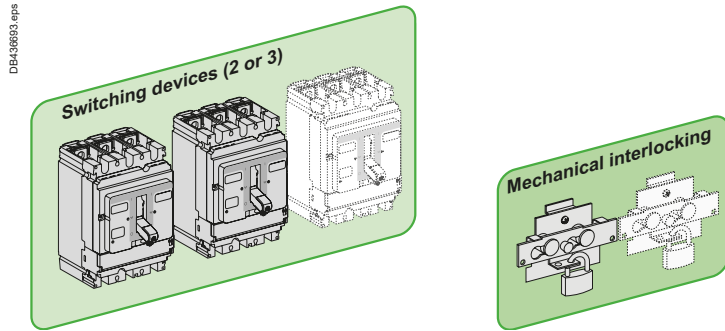

R/A

Remote-operated source-changeover system (or RTSE: Remote Transfer Switching Equipment)

Automatic source-changeover system (or ATSE: Automatic Transfer Switching Equipment)

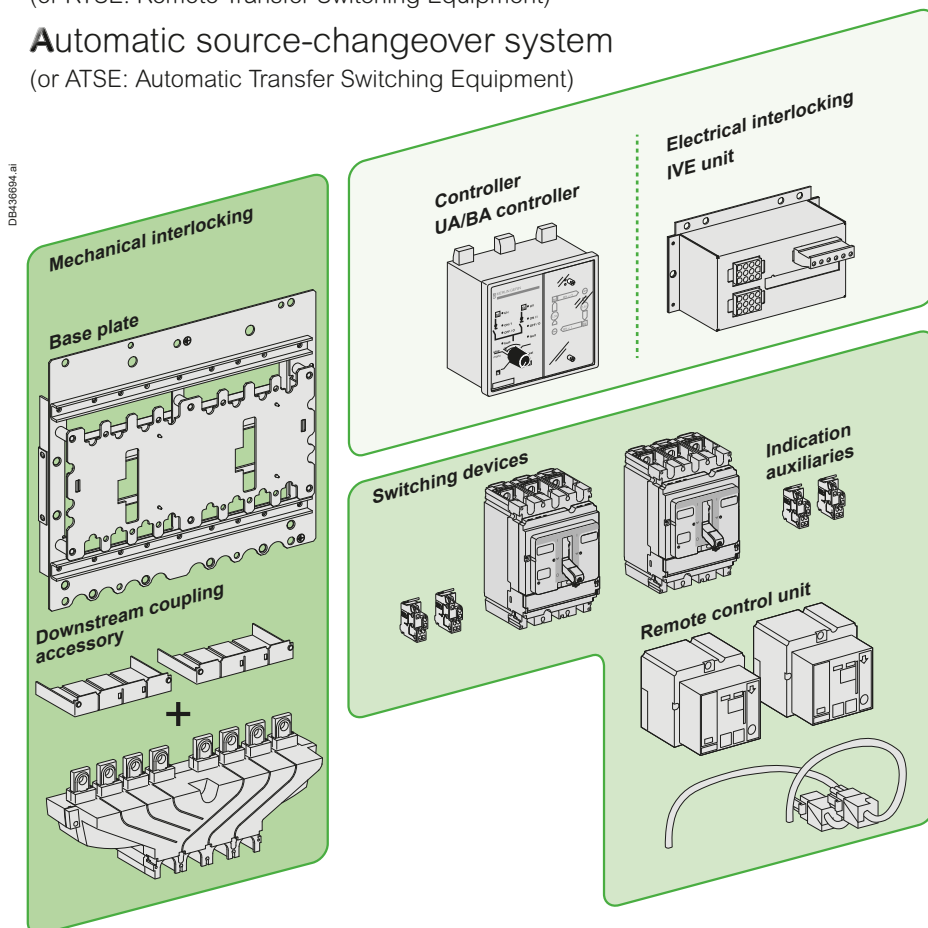

Customize Circuit Breakers with Accessories

ComPacT NSX Accessories and Auxiliaries

Mechanical Interlocking

Interlocking of Two or Three Toggle-Controlled Devices

Interlocking system

Two devices can be interlocked using this system. Two identical interlocking systems can be used to interlock three devices installed side by side.

Authorized positions:

- One device closed (ON), the others open (OFF)
- All devices open (OFF).

The system is locked using one or two padlocks (shackle Ø5 to 8 mm).

This system can be expanded to more than three devices.

There are two interlocking-system models:

- One for ComPacT INS/INV
- One for ComPacT NSX100 to NSX250
- One for ComPacT NSX400 to NSX630.

Combinations of Normal and Replacement devices

All toggle-controlled fixed or plug-in ComPacT NSX100 to NSX630 circuit breakers and switch-disconnectors of the same frame size can be interlocked. The devices must be either all fixed or all plug-in versions.

Interlocking of Two Devices by Rotary Handles

Interlocking system

Interlocking involves padlocking the direct and extended rotary handles on two devices which may be either circuit breakers or switch-disconnectors.

Authorized positions:

- One device closed (ON), the other open (OFF)
- Both devices open (OFF).

The system is locked using up to three padlocks (shackle Ø5 to 8 mm).

There are two interlocking-system models:

- One for ComPacT INS/INV
- One for ComPacT NSX100 to NSX250
- One for ComPacT NSX400 to NSX630.

Combinations of Normal and Replacement devices

All rotary-handle fixed or plug-in ComPacT NSX100 to NSX630 circuit breakers and switch-disconnectors of the same frame size can be interlocked. The devices must be either all fixed or all plug-in versions.

Interlocking of Two Devices by Base Plate

Interlocking system

A base plate designed for two ComPacT NSX devices can be installed horizontally or vertically on a mounting rail. Interlocking is carried out on the base plate by a mechanism located behind the devices. In this way, access to the device controls and trip units is not blocked.

Combinations of Normal and Replacement devices

All rotary-handle and toggle-controlled ComPacT NSX100 to NSX630 circuit breakers and switch-disconnectors can be interlocked. Devices must be either all fixed or all plug-in versions, with or without earth-leakage protection or measurement modules.

An adaptation kit is required to interlock:

- Two plug-in devices
- A ComPacT NSX100 to NSX250 with an NSX400 to NSX630.

Connection to the downstream installation can be made easier using a coupling accessory.

Interlocking of Devices by Keylocks (Captive Keys)

Interlocking using keylocks is very simple and makes it possible to interlock two or more devices that are physically distant or that have very different characteristics, for example medium-voltage and low-voltage devices or a ComPacT NSX100 to NSX630 switch-disconnector and circuit breaker.

Interlocking system

Each device is equipped with an identical keylock and the key is captive on the closed (ON) device. A single key is available for all devices. It is necessary to first open (OFF position) the device with the key before the key can be withdrawn and used to close another device.

A system of wall-mounted captive key boxes makes a large number of combinations possible between many devices.

Combinations of Normal and Replacement devices

All rotary-handle ComPacT NSX100 to NSX630 circuit breakers and switch-disconnectors can be interlocked between each other or with any other device equipped with the same type of keylock.



Interlocking of two or three toggle-controlled devices



Interlocking of two devices by rotary handles

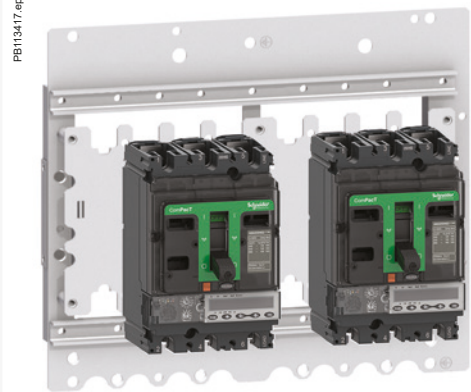

Interlocking on a base plate

> TransferPacT (source-changeover systems)



LVPED216028EN

ComPacT NSX Accessories and Auxiliaries

Mechanical and Electrical Interlocking for Source-Changeover Systems

PB113419.eps



Remote-operated source-changeover system

- A** Circuit breaker QS1 equipped with a motor mechanism and auxiliary contacts, connected to the N source
- B** Circuit breaker QS2 equipped with a motor mechanism and auxiliary contacts, connected to the R source
- C** Base plate with mechanical interlocking
- D** Electrical interlocking unit IVE
- E** Coupling accessory (downstream connection)

DB41733.eps

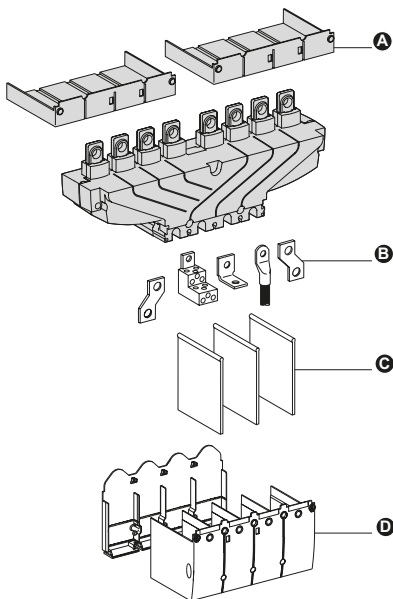

- A** Short terminal shields
- B** Terminals
- C** Interphase barriers
- D** Long terminal shields

It is made up of two devices with motor mechanisms, mounted on a base plate and combined with:

- An electrical interlocking unit
- Optional mechanical interlocking system.

Electrical interlocking unit (IVE)

Interlocks two devices equipped with motor mechanisms and auxiliary contacts. The IVE unit is mandatory to ensure the necessary time-delays required for safe switching.

Mechanical interlocking system

The mechanical interlocking system is strongly recommended to limit the effects of design or wiring errors and to avoid manual switching errors.

DB423006.ai

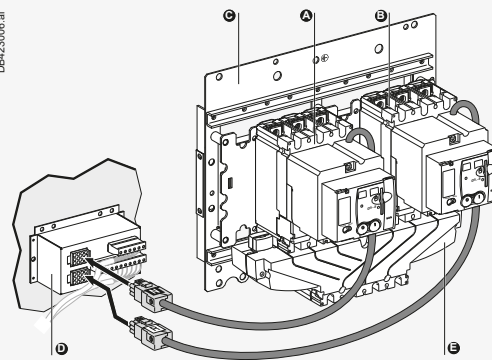

Downstream Coupling Accessory

This accessory simplifies connection to bars and cables with lugs. It may be used to couple two circuit breakers of the same size.

Pitch between outgoing terminals:

- ComPacT NSX100 to NSX250: 35 mm
- ComPacT NSX400 to NSX630: 45 mm.

For ComPacT NSX circuit breakers, the downstream coupling accessory can be used only with **fixed versions**.

Connection and Insulation Accessories

The coupling accessory can be fitted with the same connection and insulation accessories as the circuit breakers.

Possible Uses	Downstream Coupling	
	Possible mounting	Outgoing pitch (mm)
Remote-operated source-changeover systems		
NSX100 to NSX250	●	35
NSX400 to NSX630	●	45

ComPacT NSX Accessories and Auxiliaries

Automatic Source-Changeover Systems with Controller

By combining a remote-operated source-changeover system with an integrated BA or UA automatic controller, it is possible to automatically control source transfer according to user-selected sequences. These controllers can be used on source-changeover systems comprising 2 circuit breakers. For source-changeover systems comprising 3 circuit breakers, the automatic control diagram must be prepared by the installer as a complement to diagrams provided in the “electrical diagrams” section of the catalog source-changeover systems.

Functions of the BA and UA Controllers



BA controller



UA controller



TransferPacT ACP control plate

Controller		BA	UA				
Compatible circuit breakers		ComPacT NSX100 to 630 circuit breakers					
4-position switch							
Automatic operation		<input checked="" type="radio"/>	<input checked="" type="radio"/>				
Forced operation on Normal source		<input checked="" type="radio"/>	<input checked="" type="radio"/>				
Forced operation on Replacement source		<input checked="" type="radio"/>	<input checked="" type="radio"/>				
Stop (both Normal and Replacement sources OFF)		<input checked="" type="radio"/>	<input checked="" type="radio"/>				
Automatic operation							
Monitoring of the Normal source and automatic transfer from one source to the other		<input checked="" type="radio"/>	<input checked="" type="radio"/>				
Engine generator set start-up control			<input checked="" type="radio"/>				
Delayed shutdown (adjustable) of engine generator set			<input checked="" type="radio"/>				
Load shedding and reconnection of non-priority loads			<input checked="" type="radio"/>				
Transfer to Replacement source if one of the Normal source phases is absent			<input checked="" type="radio"/>				
Test							
By opening the P25M circuit breaker upstream of the controller		<input checked="" type="radio"/>					
By pressing the test button on the front of the controller			<input checked="" type="radio"/>				
Indications							
Circuit-breaker status indication on the front of the controller: ON, OFF, fault trip		<input checked="" type="radio"/>	<input checked="" type="radio"/>				
Automatic-mode indication contact		<input checked="" type="radio"/>	<input checked="" type="radio"/>				
Other functions							
Selection of type of Normal source (single-phase or three-phase)			<input checked="" type="radio"/>				
Voluntary transfer to Replacement source		<input checked="" type="radio"/>	<input checked="" type="radio"/>				
Forced operation on Normal source if Replacement source is not operational			<input checked="" type="radio"/>				
Additional test contact (not part of controller)		<input checked="" type="radio"/>	<input checked="" type="radio"/>				
Transfer to Replacement source only if contact closed (e.g. for a UR frequency check)		<input checked="" type="radio"/>	<input checked="" type="radio"/>				
Setting of maximum start-up time for the Replacement-source			<input checked="" type="radio"/>				
Power supply							
Control voltages ^[1]	220 to 240 V 50/60 Hz	<input checked="" type="radio"/>	<input checked="" type="radio"/>				
	380 to 415 V 50/60 Hz	<input checked="" type="radio"/>	<input checked="" type="radio"/>				
	440 V 60 Hz	<input checked="" type="radio"/>	<input checked="" type="radio"/>				
Operating thresholds							
Undervoltage	0.35 Un ≤ voltage ≤ 0.7 Un	<input checked="" type="radio"/>	<input checked="" type="radio"/>				
Phase failure	0.5 Un ≤ voltage ≤ 0.7 Un		<input checked="" type="radio"/>				
Voltage presence	voltage ≥ 0.85 Un	<input checked="" type="radio"/>	<input checked="" type="radio"/>				
Characteristics of output contacts (dry, volt-free contacts)							
Rated thermal current (A)	8						
Minimum load	10 mA at 12 V						
		AC				DC	
		AC12	AC13	AC14	AC15	DC12	DC13
Utilization category (IEC 60947-5-1)							
Operational current (A)	24 V	8	7	5	6	8	2
	48 V	8	7	5	5	2	-
	110 V	8	6	4	4	0.6	-
	220/240 V	8	6	4	3	-	-
	250 V	-	-	-	-	0.4	-
	380/415 V	5	-	-	-	-	-
	440 V	4	-	-	-	-	-
660/690 V	-	-	-	-	-	-	

[1] The controller is powered by the ACP control plate. The same voltage must be used for the ACP plate, the IVE unit and the circuit-breaker operating mechanisms. If this voltage is the same as the source voltage, then the “Normal” and “Replacement” sources can be used directly for the power supply. If not, an isolation transformer must be used.



ComPacT NSX Accessories and Auxiliaries

Additional Measurement Module: PowerLogic PowerTag NSX

PowerTag NSX is a ComPacT NSX wireless-communication modules for 3P and 3P+N electrical networks, mounted directly on the bottom side of the circuit breaker or the VigiPacT add-on. PowerTag NSX provides capability to measure energy, monitor voltage loss, and trigger alarms. It then delivers useful data for monitoring and diagnosis of the associated circuit breaker to a concentrator.

In combination with PowerTag, you can take advantage of a full wireless class 1 solution to monitor energy and to be aware in case of voltage loss or alarming at any level of a distribution panel, being able to take immediately the right actions in case of electrical issue. In addition to monitoring and alarming, PowerTag solution provides a complete knowledge of real time electrical values with a rich and accurate data transfer every 5 seconds.

PowerTag energy sensors can be quickly and easily installed in new or existing panels at any time. Compared to traditional metering solutions, installation time and commissioning are much shorter with no wiring, hence an error proof high density solution and a built-in class 1 accuracy.



PowerLogic PowerTag NSX

Functions

PowerTag NSX energy sensor measures the following values in accordance with the IEC 61557-12 standard:

- Energy (4 quadrants):
 - Active energy (kWh): total and partial, delivered and received
 - Active energy per phase (kWh): total
 - Reactive energy (VARh): partial, delivered and received.
- Power:
 - Active power (W): total and per phase
 - Reactive power (VAR): total
 - Apparent power (VA): total.
- Voltages (V): phase-to-phase (U12, U23, U31) and phase-to-neutral (V1N, V2N, V3N)
- Currents (A): per phase (I1, I2, I3)
- Frequency
- Power factor
- Voltage loss alarm:
 - PowerTag energy sensor sends a "voltage loss" alarm and the current-per-phase value before being de-energized,
 - At "voltage loss", PowerTag adds an overload alarm if the current is higher than the rated current of the associated protective device.

Installation

The module is self-powered and is installed for fixed devices directly on the bottom side of the circuit breaker or VigiPacT add-on terminals. For plug-in devices, it has to be installed on the base itself.

PowerTag NSX 3P has to be used with 3P devices, and an external neutral voltage tap is provided in case of the installation has a neutral to provide phase-to-neutral voltages, active energy per phase and power per phase. PowerTag 3P+N has to be used with 4P devices.

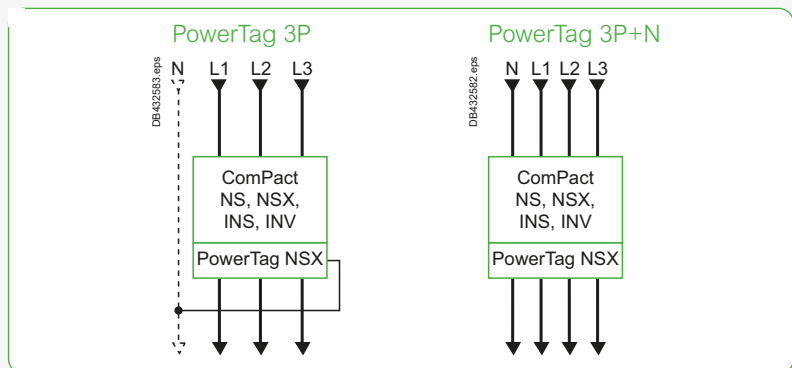

PowerTag NSX modules are compatible with ComPacT NSX100/160/250, ComPacT NSX400/630, ComPacT INS250-100A to 250A, ComPacT INS320/400/500/630, ComPacT INV100/160/200/250, ComPacT INV320/400/500/630, ComPacT NS100/160/250 and ComPacT NS400/630.

In case of retrofit, following points have to be checked:

- Clearance to be able to add PowerTag module (see dimensions in chapter E) and to respect bending radius of cables.
- Condition of power connectors: to be replaced if damaged.
- Tightening torques depending of the connector used.

ComPacT NSX Accessories and Auxiliaries

Additional Measurement Module: PowerLogic PowerTag NSX

How to Install PowerTag in Your Existing Panel



How to Commission Your PowerTag







Introducing PowerTag® The Smallest Wireless Energy Sensor Available



Integration in Concentrator

PowerTag Link concentrate wirelessly data from PowerTag and make them available over Ethernet:

For Commercial & Building applications		
PowerTag Link (Monitoring)	PowerTag Link HD (Monitoring)	Smartlink SI B (Monitoring & Control)
 <p>A9XMWD20_image.eps</p>	 <p>A9XMWD100_image.eps</p>	 <p>PB113286_120.eps</p>
A9XMWD20	A9XMWD100	A9XMZA08

For Small Business applications
PowerTag Link C (Monitoring)
 <p>DB428088.eps</p>
A9XELC10

Concentrator embedded web pages allow:

- To do commissioning.
- To display measured values.
- To set and display alarms and pre-alarms.

PowerTag NSX is also compatible with Wiser Energy (Residential). Refer to the concentrator catalogs for more information.

Commissioning

Commissioning can be done very easily:

- For PowerTag Link C: with a smartphone
- For PowerTag Link, PowerTag Link HD and Smartlink SI B: with embedded webpages or with EcoStruxure Power Commission which provides a test report for system integration with all the Modbus registers, including bits and descriptions associated.



ComPacT NSX Accessories and Auxiliaries

Additional Measurement Module: PowerLogic

PowerTag NSX

How to Monitor
PowerTag NSX
Sensors in FDM128
Local Display



Metering and Monitoring

PowerTag Link/PowerTag Link HD
(Ethernet)

Metering, Monitoring and Control

Smartlink SI B (Ethernet)

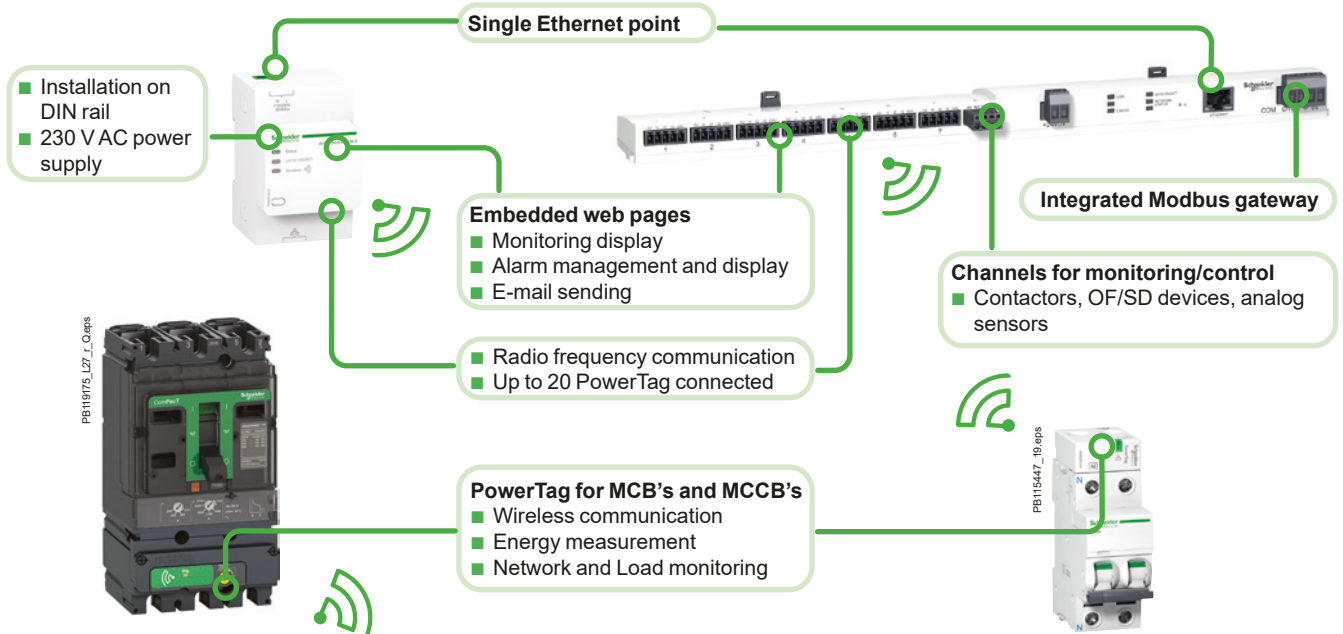

Technical Characteristics

Main characteristics			
Rated voltage	Un	Phase-to-neutral	230 VAC ± 20 %
		Phase-to-phase	400 VAC ± 20 %
Frequency			50/60 Hz
Operating current	In		250 A/630 A
Maximum operating current			1.2 x In
Saturation current			2 x In
Maximum consumption			3.7 VA
Starting current	Ist		160 mA/400 mA
Base current	Ib		40 A/100 A
Additional characteristics			
Operating temperature			-25 °C to +70 °C
Storage temperature			-50 °C to +85 °C
Overtoltage category		As per IEC 61010-1	Cat. IV
Measuring category		As per IEC 61010-2-30	Cat. III
Pollution degree			3
Altitude			Up to 2000 m without derating ^[1]
Degree of protection device			IP20 IK07
Radio-frequency communication			
ISM band 2.4 GHz			2.4 GHz to 2.4835 GHz
Channels		As per IEEE 802.15.4	11 to 26
Isotropic Radiated Power		Equivalent (EIRP)	0 dBm
Maximum transmission time			< 5 ms
Channel occupancy		For 1 device	Messages sent every 5 seconds
Characteristics of measuring functions			
Function	Symbol	Performance as per IEC 61557-12	Measuring range (250 A/630 A)
Active power (per phase, total)	P	Class 1	4 to 250 A/10 to 630 A
Total reactive power	Q _A	2	
Total apparent power	S _A	2	
Active Energy (per phase, total, partial)	E _a	1	
Total reactive Energy	E _{rA}	2	
Frequency	f	1	45 to 55 Hz
Phase current	I	1	8 to 250 A/20 to 630 A
Voltages (Line to Line)	U	0.5	Un ± 20 %
Power factor (arithmetic)	PF _A	1	From 0.5 inductive to 0.8 capacitive
			-1 to 1

[1] Above 2000 m, please consult us.

ComPacT NSX Accessories and Auxiliaries

Additional Measurement Module: PowerLogic PowerTag NSX

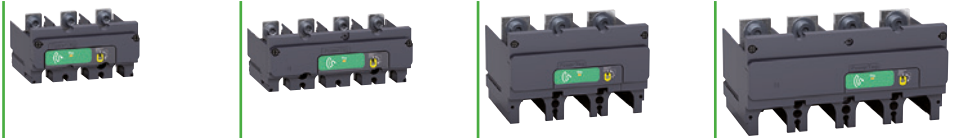

Products (AC network)	Mounting position	250 3P	250 3P+N	630 3P	630 3P+N
ComPacT					
Circuit breakers					
NSX100/160/250 B/F/N/H/S/L/R Fixed	3P Bottom	✓	-	-	-
	4P Bottom	-	✓	-	-
NSX400/630 F/N/H/S/L/R Fixed	3P Bottom	-	-	✓	-
	4P Bottom	-	-	-	✓
NSX100/160/250 B/F/N/H/S/L/R Plug-In (mounted on the base)	3P Top/Bottom	✓	-	-	-
	4P Top/Bottom	-	✓ [1]	-	-
NSX400/630 F/N/H/S/L/R Plug-In (mounted on the base)	3P Top/Bottom	-	-	✓ [2]	-
	4P Top/Bottom	-	-	-	✓ [1] [2]
NS100/160/250 N/SX/H/L Fixed	3P Bottom	✓	-	-	-
	4P Bottom	-	✓	-	-
NS400/630 N/H/L Fixed	3P Bottom	-	-	✓	-
	4P Bottom	-	-	-	✓
NS100/160/250 N/SX/H/L Plug-in (mounted on the base)	3P Top/Bottom	✓	-	-	-
	4P Top/Bottom	-	✓ [1]	-	-
NS400/630 N/H/L Plug-in (mounted on the base)	3P Top/Bottom	-	-	✓ [2]	-
	4P Top/Bottom	-	-	-	✓ [1] [2]
Circuit breakers equipped with Vigi block					
NSX100/160/250 B/F/N/H/S/L/R Fixed	3P Bottom	✓	-	-	-
	4P Bottom	-	✓	-	-
NSX400/630 F/N/H/S/L/R Fixed	3P Bottom	-	-	✓	-
	4P Bottom	-	-	-	✓
NSX100/160/250 B/F/N/H/S/L/R Plug-In (mounted on the base)	3P Top	✓	-	-	-
NSX400/630 F/N/H/S/L/R Plug-In (mounted on the base)	3P Top	-	-	✓ [2]	-
Switches					
INS250/INV - 100/160/200/250	3P Bottom	-	✓	-	-
	4P Top/Bottom	-	✓ [1]	-	-
INS/INV - 320/400/500/630	3P Bottom	-	-	-	✓
	4P Top/Bottom	-	-	-	✓ [1]

[1] Neutral on the right when mounted on top side

[2] When plate mounted, need to add an intercalary wedging plate under the PowerTag module with following dimensions:

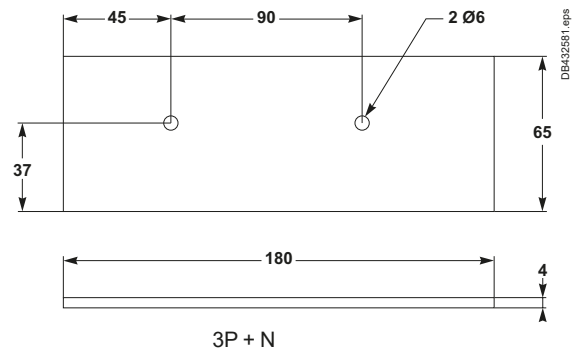
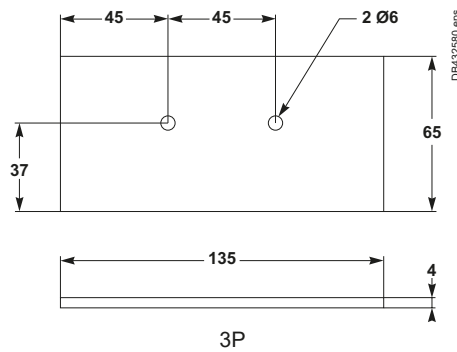

ComPacT NSX Accessories and Auxiliaries

Additional Measurement and Indication Modules

PF105123_C.eps



ComPacT NSX with current-transformer module

C

Current-Transformer Module

This module enables direct connection of a measurement device such as a power meter.

Installation

- The module is installed directly on the downstream circuit-breaker terminals.
- Degree of protection IP40, IK04.
- Class II insulation between front and the power circuits.
- Connection to 6 integrated connectors for cables up to 2.5 mm².

Electrical characteristics

- Current transformer with 5 A secondary winding.
- Class 3 for the following output-power consumptions:

Accuracy:

- 100 A rating: 1.6 VA
- 150 A rating: 3 VA
- 250 A rating: 5 VA
- 400/600 A rating: 8 VA.

Current-Transformer Module with Voltage Measurement Outputs

This module enables direct connection of a digital measurement device such as a Power Meter PM700, PM800, etc. (not supplied).

Installation

- The module is installed directly on the downstream circuit-breaker terminals.
- Degree of protection IP40, IK04.
- Class II insulation between front and the power circuits.
- Built-in connectors for cables from 1.5 to 2.5 mm².

Electrical characteristics

- Rated operational voltage U_e: 530 V.
- Frequencies of measured values: 50...60 Hz.
- Three CTs with 5 A secondary windings for the rated primary current I_n:
 - Class 0.5 to 1 for rated power consumption values at the output:
 - 125 A, 150 A and 250 A ratings: class 1 for 1.1 VA
 - 400/600 A rating: class 0.5 for 2 VA
 - Connection using a 2.5 mm² cable up to 2.5 m long.
- Four voltage measurement outputs including protection with automatic reset.
 - Voltage measurement output resistance 3500 Ω ±25 %, maximum current 1 mA
 - The voltage measurement outputs are intended only for measurements (1 mA max.) and may not be used to supply the display.

Customize Circuit Breakers with Accessories

ComPacT NSX Accessories and Auxiliaries

Additional Measurement and Indication Modules

VigiPacT Add-on Alarm

This module detects and indicates an insulation drop on a load circuit (TN-S or TT systems).

Operation is identical to that of a VigiPacT add-on, but without circuit-breaker tripping.

Indication by a red LED in front.

An auxiliary contact may be installed for remote insulation-drop indications.

When insulation drops below a minimum, user-set threshold, the LED goes on and the auxiliary contact switches. The fault indication cannot be cancelled except by pressing the manual reset button.

Installation

- The module is installed directly on the downstream circuit-breaker terminals.
- Degree of protection IP40, IK04.
- Double insulation of the front face.

Electrical characteristics

- Settings: 100 - 200 - 500 - 1000 mA.
- Accuracy: -50 +0 %.
- Time delay following insulation drop: 5 to 10 seconds.
- AC-system voltage: 200 to 440 V AC.



VigiPacT add-on alarm

ComPacT NSX Accessories and Auxiliaries

Locks

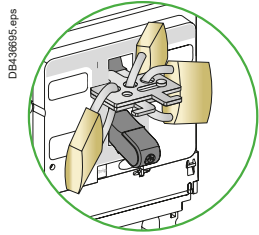

Toggle locking using padlocks and an accessory:
Removable device

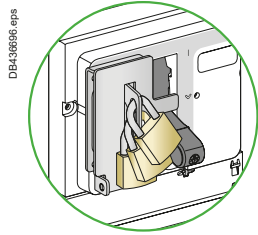

Fixed device attached to the case ^[3]

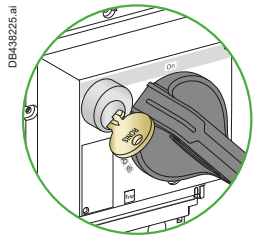

Rotary-handle locking using a keylock

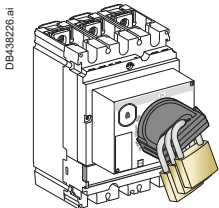

Rotary-handle locking using a padlock or a keylock

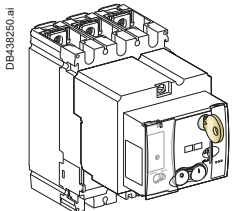
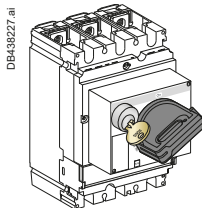

Motor-mechanism locking using a padlock or a keylock

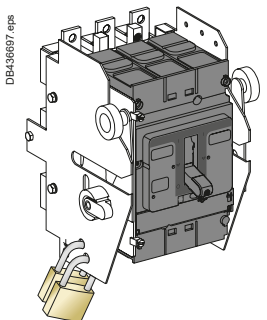
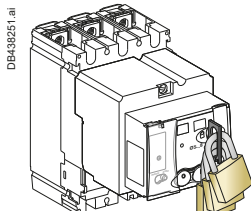

Chassis locking in the connected position

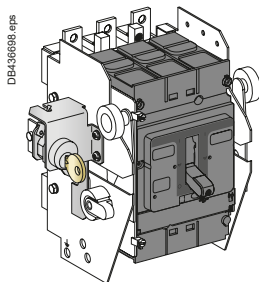

Locking in the OFF position guarantees isolation as per IEC 60947-2. Padlocking systems can receive up to three padlocks with shackle diameters ranging from 5 to 8 mm (padlocks not supplied). Certain locking systems require an additional accessory.

Control device	Function	Means	Required accessories
Toggle	Lock in OFF position	Padlock	Removable device
	Lock in OFF or ON position	Padlock	Fixed device
Direct rotary handle	Lock in	Padlock	-
	■ OFF position	Keylock	Locking device + keylock
	■ OFF or ON position ^[1]		
MCC	Lock in	Padlock	-
	■ OFF position		
	■ OFF or ON position ^[1]		
CNOMO	Lock in	Padlock	-
	■ OFF position		
	■ OFF or ON position ^[1]		
Extended rotary handle	Lock in	Padlock	-
	■ OFF position		
	■ OFF or ON position ^[1] with door opening prevented ^[2]		
	Lock in OFF position	Padlock	UL508 control accessory
	■ OFF or ON position ^[1] inside the switchboard	Keylock	Locking device + keylock
Motor mechanism	Lock in OFF position	Padlock	-
	remote operation disabled	Keylock	Locking device + keylock
Withdrawable circuit breaker	Lock in	Padlock	-
	■ disconnected position	Keylock	Locking device + keylock
	■ connected position	Keylock	Locking device + keylock

[1] Following a simple modification of the mechanism.

[2] Unless door locking has been voluntarily disabled.

[3] Only for 3P-4P.



Customize Circuit Breakers with Accessories

ComPacT NSX Accessories and Auxiliaries

Sealing Accessories

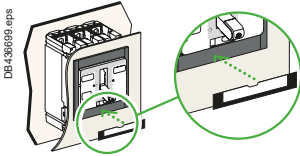

Identification accessories

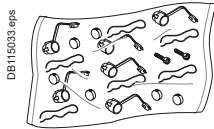

Sealing accessories

Outgoing-Circuit Identification

ComPacT NSX 100 to 630 can be equipped with label holders supplied in sets of ten (cat. no. LV429226). They are compatible with escutcheons.

Sealing Accessories

Sealing accessories are available. Each bag of accessories contains all the parts required for the types of sealing indicated below.

- A bag contains:
- 6 sealing accessories
 - 6 lead seals
 - 0.5 m of wire
 - 2 screws.

Types of Seals and Corresponding Functions

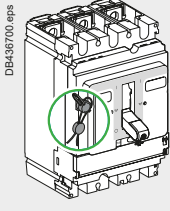
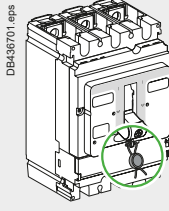
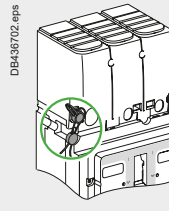
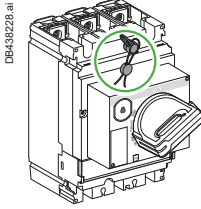
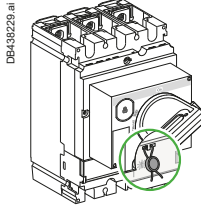
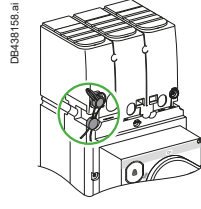
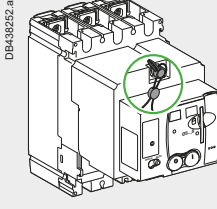
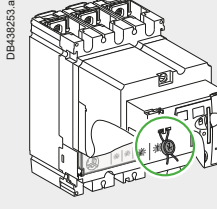
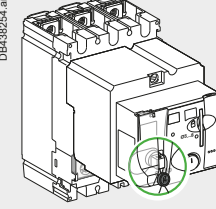
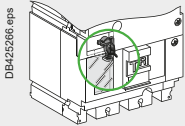
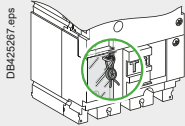
Toggle control			
Rotary handle			
Motor mechanism			
Types of seals	Front-cover fixing screw	Trip-unit transparent cover	Motor-mechanism transparent cover
Protected operations	<ul style="list-style-type: none"> ■ Front removal ■ Access to auxiliaries ■ Trip-unit removal. 	<ul style="list-style-type: none"> ■ Modification of settings ■ Access to test connector. 	<ul style="list-style-type: none"> ■ Access to manual/auto mode selection switch: depending on its position, manual [1] or automatic operation is not possible. <p>[1] In this case, local operation is not possible.</p>
Access to VigiPacT add-on settings			
Types of seals	VigiPacT add-on fixing device	Protection cover for settings	
Protected operations	<ul style="list-style-type: none"> ■ Removal of the VigiPacT add-on. 	<ul style="list-style-type: none"> ■ Modification of settings. 	



ComPacT NSX Accessories and Auxiliaries

Escutcheons and Protection Collars

Escutcheons are an optional feature mounted on the switchboard door. They increase the degree of protection to IP40, IK07. Protection collars maintain the degree of protection, whatever the position of the device (connected, disconnected).

PB105119.eps



IP30 escutcheon

PB105120.eps



IP30 escutcheon with access to the trip unit

IP30 or IP40 Escutcheons for Fixed Devices

IP30

The three types are glued to the cut-out in the front door of the switchboard:

- Escutcheon for all control types (toggle, rotary handle or motor mechanism)
 - Without access to the trip unit
 - With access to the trip unit
- For VigiPacT add-on, can be combined with the above.

IP40

The four types, with a gasket, are screwed to the door cut-out:

- Three escutcheons identical to the previous, but IP40
- A wide model for Vigi modules that can be combined with the above.

DE436703.eps

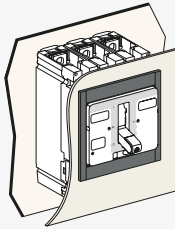

DE436704.eps

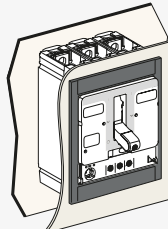

Escutcheon for toggle without and with access to the trip unit

DE436705.eps

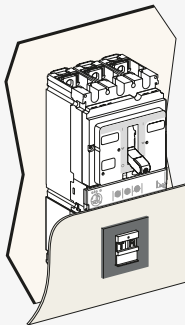

Escutcheon for VigiPacT add-on

Customize Circuit Breakers with Accessories

ComPacT NSX Accessories and Auxiliaries

Escutcheons and Protection Collars

IP40 Escutcheons for Withdrawable Devices

IP40 for Withdrawable Devices

The two types, with a gasket, are screwed to the door cut-out:

- For rotary handle or motor mechanism: standard IP40 escutcheon
- For toggle with extension: standard escutcheon + collar for withdrawal.

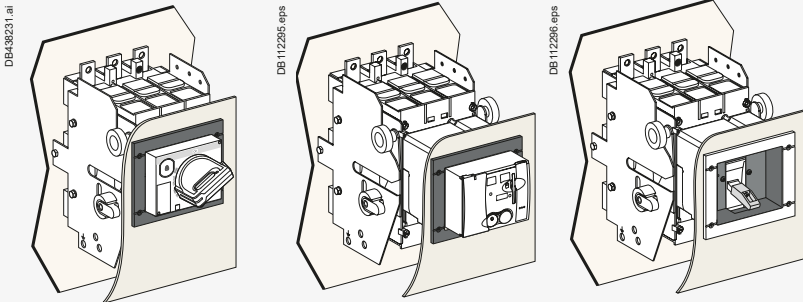

Standard escutcheon with rotary handle

Standard escutcheon for motor mechanism

Standard escutcheon with collar for withdrawal, for toggle

IP40 for VigiPacT Add-on on Withdrawable Devices

The two types, with a gasket, are screwed to the door cut-out:

- For rotary handle or motor mechanism: standard IP40 escutcheon
- For toggle: standard escutcheon + collar for withdrawal.

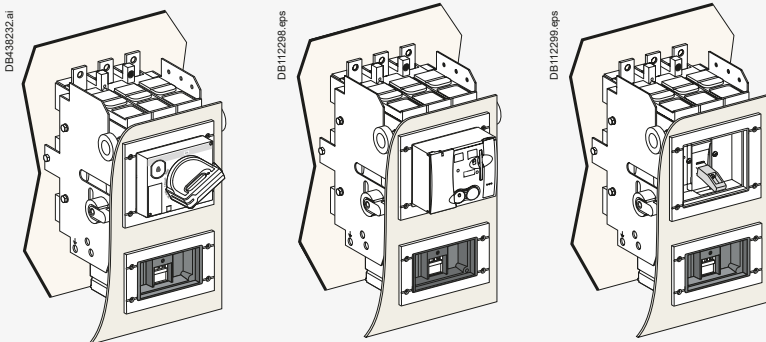

Escutcheon for VigiPacT add-on, with escutcheons for the three types of control

IP43 Toggle Cover

Available only for devices with toggles. Fits over toggle and front cover of the device.

- Mounted on the front of the circuit breaker.
- Degree of protection IP43, IK07.



Toggle cover



Toggle cover

Retrofit Front Covers

These replacement front covers make it possible to install NSX devices in existing switchboards containing NS devices by installing the NS-type retrofit covers on the NSX devices.

- NS100 to 250 cover.
- NS400/630 cover.



NS retrofit front cover



PB103775-40.eps

PB103820_35.eps

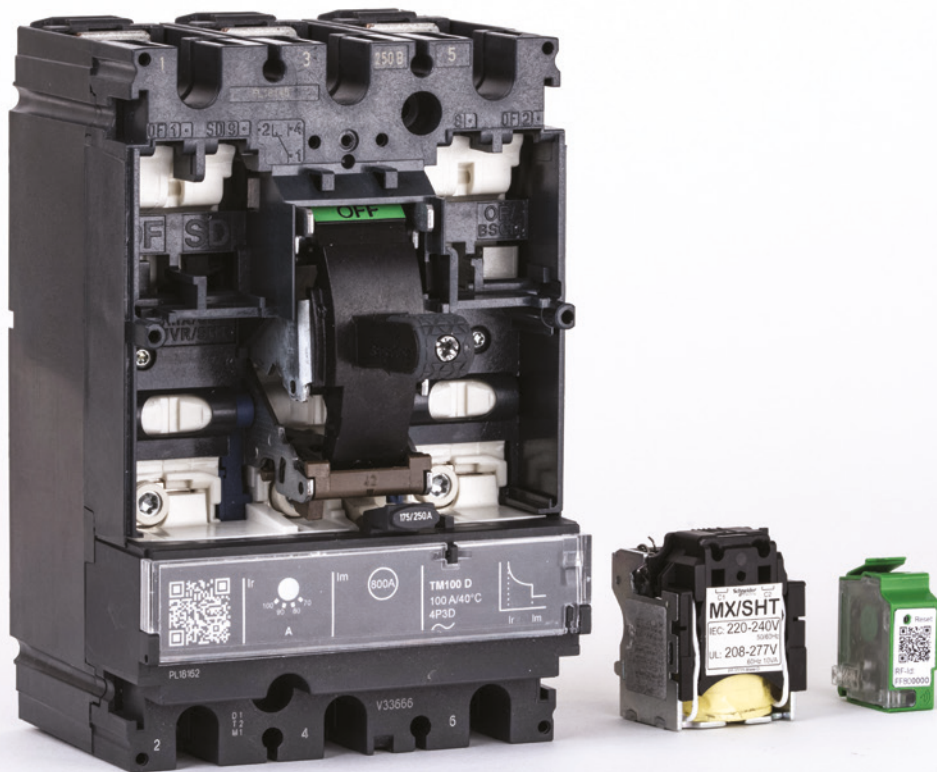

Smart Panel Integration

Enerlin'X Functions	
Communication Wiring System.....	D-2
Overview of Functions.....	D-3
Enerlin'X Digital System	
Overview.....	D-4
Com'X 510	
Energy Server.....	D-6
FDM128 Ethernet Switchboard Display.....	D-7
FDM121 Switchboard Display.....	D-8
Customer Engineering Tool:	
EcoStruxure Power Commission Software.....	D-10



Other Chapters	
Select Circuit Breakers and Switch-Disconnectors.....	A-1
Select Protection.....	B-1
Customize Circuit Breakers with Accessories.....	C-1
Switchboard Integration.....	E-1
Catalog Numbers.....	F-1
Glossary.....	G-1
Additional Characteristics.....	H-1

Smart Panel Integration
Enerlin'X Functions
 Communication Wiring System

Give your Electrical System a Voice with Smart Panels, from Schneider Electric

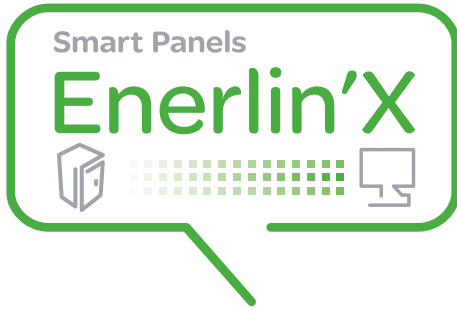

Get Circuit Breaker Status and Electrical Values Available Information and Functions



C2538E250.eps



C2545E250.eps

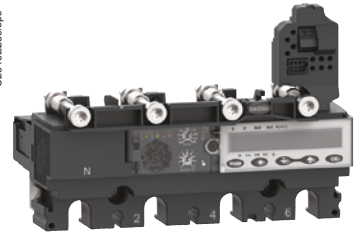

MicroLogic trip units for 3 poles, 4 poles ComPacT circuit breakers

MicroLogic E available functions

Status indications

- ON/OFF (O/F)
- Fault-trip SDE
- Connected/disconnected/test position CE/CD/CT (I/O module only)

Controls

- Open
- Close

Measurements

- Instantaneous measurement information
- Averaged measurement information
- Maximeter/minimeter
- Energy metering
- Demand for current and power
- Power quality

Operating assistance

- Protection and alarm settings
- Histories
- Time stamped event tables
- Maintenance indicators

All ComPacT circuit breakers are equipped with a MicroLogic trip unit. This adjustable unit is mainly designed for tripping the circuit breaker in case of necessity and monitoring the downstream circuit. Alarms may be programmed for remote indications. Electrical measurements, operation data for predictive maintenance, are provided for local display or distant monitoring.

D

Smart Panel Integration

Enerlin'X Functions

Overview of Functions

Fixed ComPacT NSX circuit breaker

Drawout ComPacT NSX circuit breaker

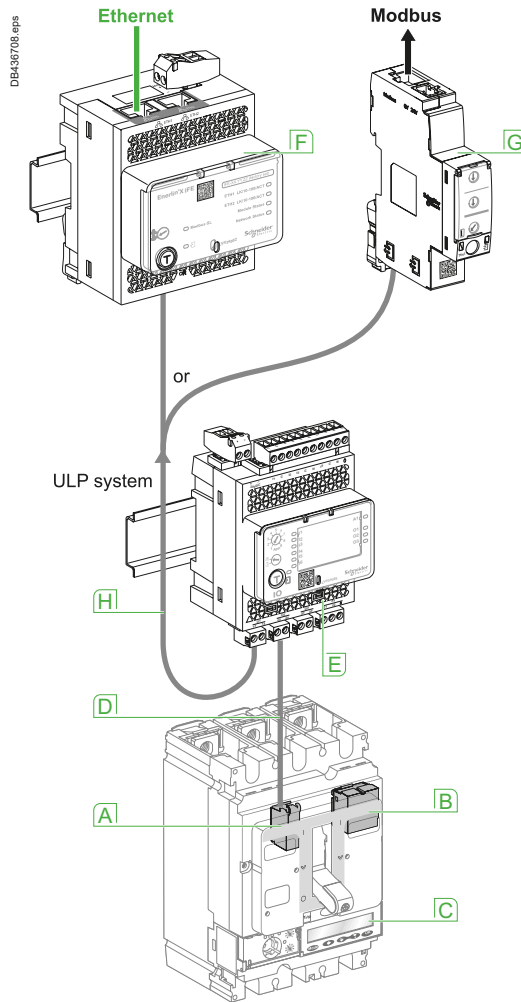
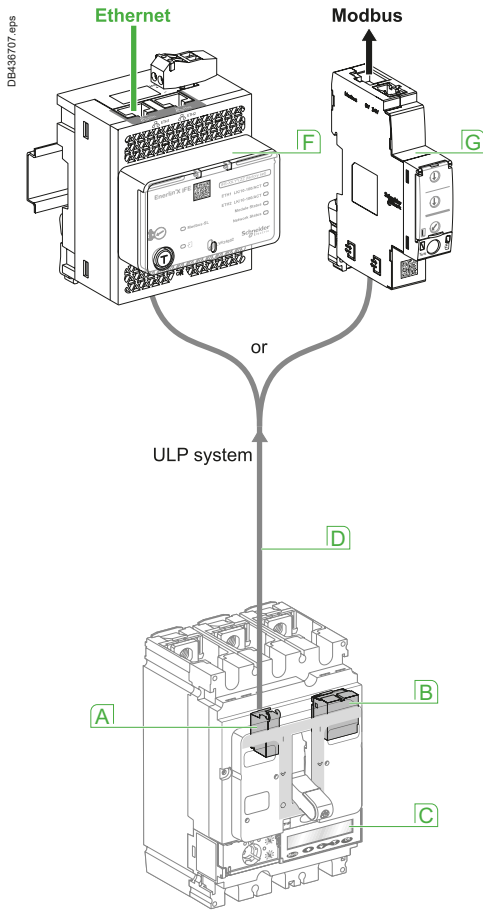

- A** Internal terminal block for communication via NSX cord
- B** BSCM module
- C** MicroLogic trip unit
- D** NSX cord
- E** I/O module
- F** IFE interface module
- G** IFM module
- H** ULP cable



ULP system

is a fast communication link dedicated to circuit breaker monitoring and control. Based on a RS485 physical liaison with cable segments up to 5 meters, it is well adapted to severe environment. A choice of 6 pre-connectorized cables with different length is provided.

IFE interface ULP to Ethernet interface module

Provides an IP address to any circuit breaker fitted with an ULP port. The IFE interface makes all available data from the circuit breaker accessible from an Ethernet compatible display (FDM128), a PC with common browser, or IFE switchboard server which generates its own web pages.

IFM ULP to Modbus Interface module

Makes all available data of a circuit breaker fitted with an ULP port accessible via a Modbus network. IFM acts as a Modbus Smartlink SI B, accessible from a Modbus Smartlink SI B (IFE switchboard server, Smartlink SI B or Com'X).

I/O I/O application module

I/O is dedicated to circuit breaker with ULP liaison. It provides the monitoring and control of any application around the circuit breaker (lighting or load control, cooling system, pulse metering acquisition...).

Enerlin'X Digital System Overview

Enerlin'X communication system provides access to status, electrical values and devices control using Ethernet and Modbus SL communication protocols.





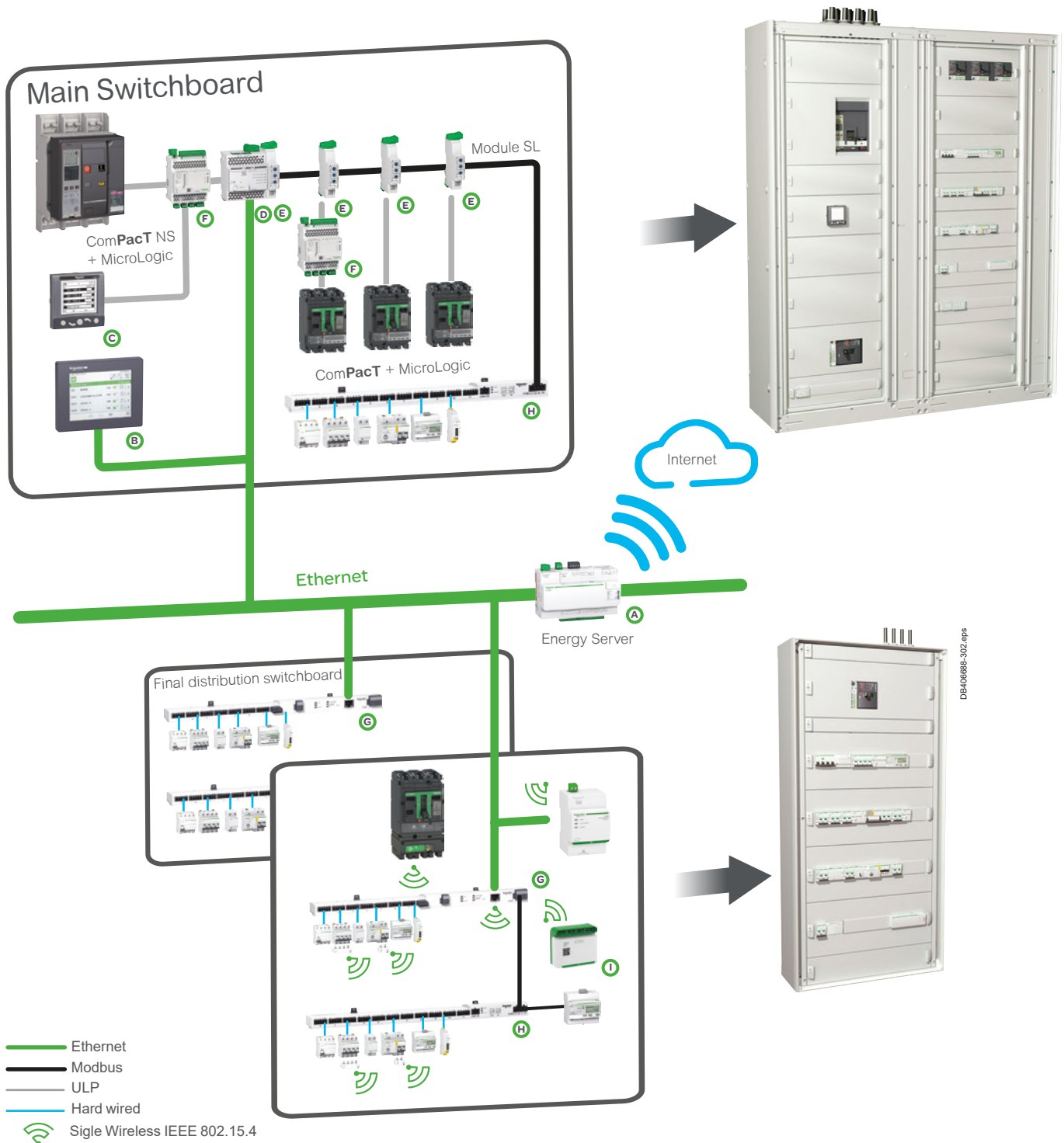



Ethernet has become the universal link between switchboards, computers and communication devices inside the building. The large amount of information which can be transferred makes the connection of Enerlin'X digital system to hosted web services of Schneider Electric a reality. More advantages are offered to integrators thanks to configuration web pages available remotely or on the local Ethernet network.

Modbus SL is the most widely used communication protocol in industrial networks. It operates in master-slave. The devices (slaves) communicate one after the other with a gateway (master).



D

Smart Panel Integration Enerlin'X Digital System Overview

Enerlin'X digital devices and displays							
	Name	Function	Port (to device)	Port (to server)	Inputs	Outputs	Cial. Ref.
A	 Com'X 210	Energy data logger + Ethernet Gateway	Ethernet Modbus Smartlink SI B, Zigbee (to wireless meters)	Ethernet cable + WiFi	64 devices: 6 binary 2 analog 32 Modbus devices + other Ethernet devices (Modbus TCP)	-	EBX210
	Com'X 510 24 V DC + PoE	Energy server + Ethernet Gateway				-	EBX510
B	 FDM128	Ethernet LCD color touch screen	-	Ethernet		-	LV434128
C	 FDM121	LCD display for circuit breaker	ULP	-	1 circuit breaker	-	TRV00121
D	 IFE Switchboard server	Switchboard server	Modbus Smartlink SI B & ULP	Ethernet	20 circuit breakers	-	LV434002
	IFE interface	Ethernet interface for circuit breakers	ULP	Ethernet	1 circuit breaker	-	LV434001
E	 IFM	Modbus interface for circuit breaker	ULP	Modbus Smartlink SI B	1 circuit breaker	-	LV434000
F	 I/O	Input/Output application module for circuit breaker	ULP	ULP	6 binary 1 analog (PT100 sensor)	3	LV434063
G	 Smartlink SI B Ethernet wireless	Ethernet server for I/O and Modbus Smartlink SI B devices	Modbus Smartlink SI B & Wireless to PowerTag	Ethernet	14 binary 2 analog	7	A9XMZA08
H	 Smartlink Modbus Smartlink SI B	Modbus interface with Input/Output functions	-	Modbus Smartlink SI B	22 binary	11	A9XMSB11
I	 HeatTag	Detection of overheating cables	-	-	-	-	SMT10020



> EcoStruxure Power Connected Products Catalog



LVCATENLX_EN

Ethernet Gateway or Interface: routes an internal traffic (ULP or other protocols) to the Internet, the outgoing messages are coded with Modbus TCP/IP protocol.

Server (Switchboard, Energy): routes the internal traffic to the Internet. Other complementary functions such as data logging and storage. Provides devices status and energy trends on internal web pages...

PowerLogic™ HeatTag: HeatTag is a smart sensor for early detection of overheating wire connections or overheating cables. HeatTag helps prevent electrical switchboards from being damaged, by analyzing gas and particles in the air and sending alerts before any smoke or insulator browning.

Note: For more information, see [Configuration & commissioning guide of connected devices & software - New buildings](#)

Com'X 510 Energy Server

EcoStruxure Power
Monitoring Expert



Main Functions

DB498122.ai

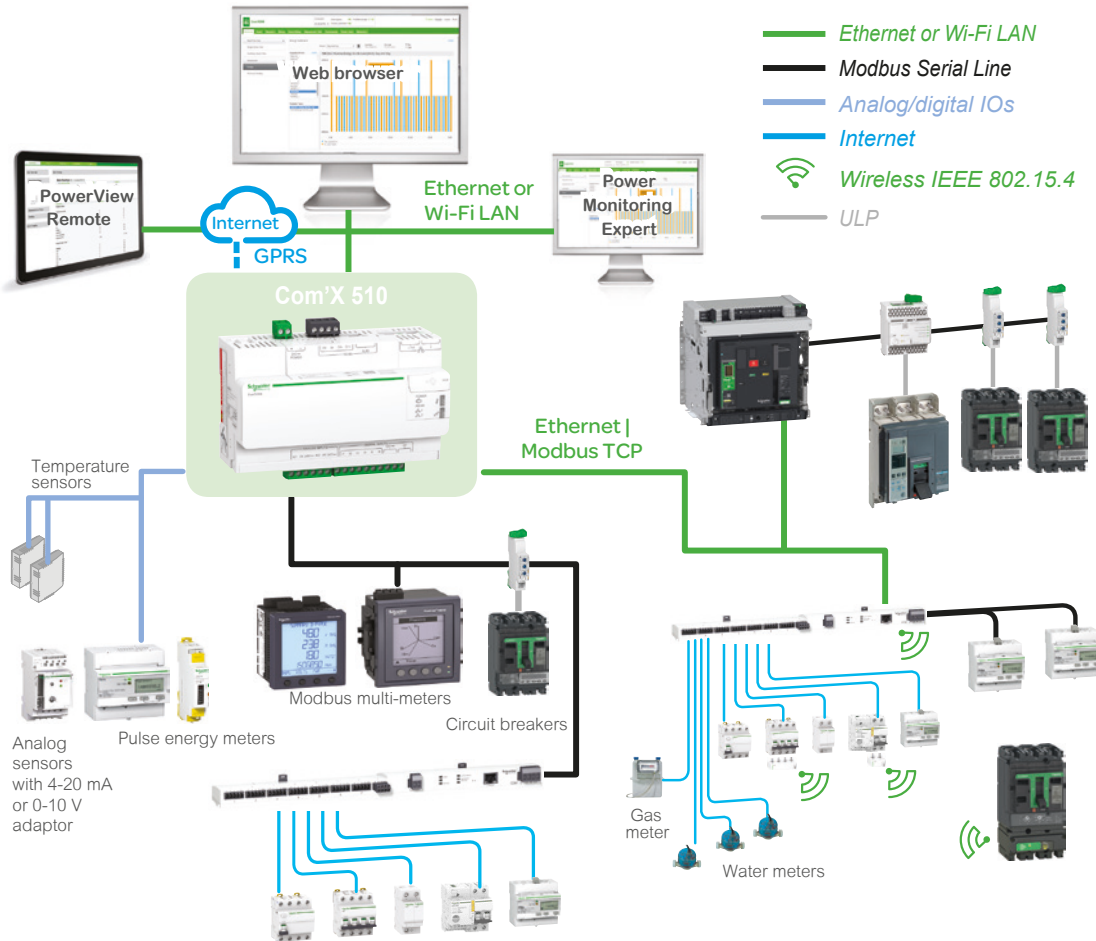

D

Basic Mobile Energy Management: Facility Managers



PB114852_08.eps

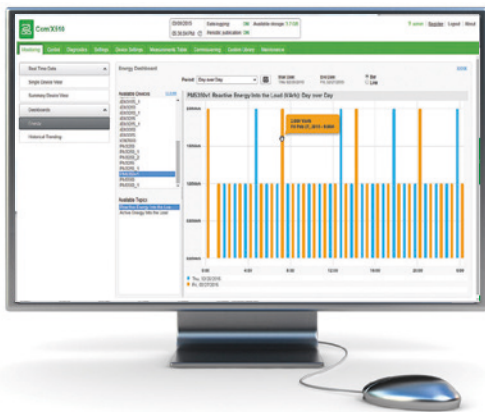

Energy dashboard comparing accumulated over time energy values (partial screen)

Data collector

Collects and stores energy data from up to 64 field devices, connected to either:

- Ethernet TCP/IP field network
- Modbus Serial line network (up to 32 devices)
- Embedded digital and analog inputs.

"Field devices" consist of:

- PowerLogic meters for power and energy monitoring
- MasterPact, PowerPact, or ComPact circuit-breakers for protection and monitoring
- Protection devices, meters, remote controlled switches, etc
- Water, air, gas, electricity, and steam consumption meters, from specialized manufacturers, delivering pulses as per standard (see table at end of this document)
- Environmental sensors such as temperatures, humidity, and CO2 levels in a building, providing analogue information.

Data logging and storage capabilities include:

- Data logging period: configurable from every minute to once a week
- Data storage duration: up to 2 years, depending on quantity of collected data
- Able to set time and send reset instructions to field devices.

Embedded energy management software

The Com'X provides the end-user with immediate visibility into energy consumption throughout the site. As soon as the Com'X is connected to the Local Area Network (LAN), several web pages are accessible via any standard web browser, (without plug-in or additional components).

These web pages display real-time data as it is collected, in easy to understand tabular and summary formats. In addition, users can get simple analysis of historical data in bar graph or trending formats.

Com'X 510 Commercial reference numbers

Com'X 510 energy server 24 V DC power supplied UL rated

EBX510

Please see your Schneider Electric representative for complete ordering information.

FDM128 Ethernet Switchboard Display

FDM128

The FDM128 is an intelligent Ethernet display. It collects the data from up to 8 devices via Ethernet network. The FDM128 switchboard display unit can be connected to a MicroLogic COM option (BCM ULP via IFE). It uses the sensors and processing capacity of the MicroLogic control unit. It is easy to use and requires no special software or settings. The FDM128 is a large display, but requires very little depth. The anti-glare graphic screen is backlit for very easy reading even under poor ambient lighting and at sharp angles.

Display of MicroLogic Measurements and Trips

The FDM128 is intended to display MicroLogic E measurements, trips and operating information. It cannot be used to modify the protection settings. Measurements may be easily accessed via a menu. Trips are automatically displayed. A pop-up window displays the time-stamped description of the trip.

Status Indications

When the circuit breaker is equipped with the Breaker Status Command Module (BSCM) and NSX cord, the FDM128 display can also be used to view circuit breaker status conditions:

- O/F: ON/OFF
- SDE: Fault-trip indication (overload, short-circuit, ground fault)
- CE, CD cradle management with I/O application module.

Remote Control

When the circuit breaker is equipped with the BSCM, NSX cord and Communicating Motor Mechanism (MTC), the FDM128 display can also be used to control (open/close) the circuit breaker.

Main Characteristics

- 115.2 x 86.4 mm with 5.7" QVGA display 320 x 240 pixels.
- Color TFT LCD, LED backlight.
- Wide viewing angle: vertical ±80°, horizontal ±70°.
- High resolution: excellent reading of graphic symbols.
- Operating temperature range -10 °C to +55 °C.
- CE/UL/CSA marking (pending).
- 24 V DC power supply, with tolerances 24 V (limit 20.4 - 28.8 V DC).
- Consumption ≤ 6.8 W.

Mounting

The FDM128 is easily installed in a switchboard.

- Standard door hole Ø 22 mm.

 The FDM128 degree of protection is IP65 in front and IP54.

Connection





The FDM128 is equipped with:

- A 24 V DC terminal block:
 - Power supply range of 24 V DC (limit 20.4 - 28.8 V DC). The FDM128 display unit has a 2-point screw connector on the rear panel of the module for this purpose.
- One RJ45 Ethernet jacks.

 The MicroLogic connects to the internal communication terminal block on the MasterPact via the breaker ULP cord and Ethernet connection through IFE.

Screens

Main menu

-  Quick view
-  Alarms
-  Metering
-  Maintenance
-  Control

When not in use, the screen is automatically shifted to low back-lighting.

Fast access to essential information

- "Quick view" provides access to five screens that display a summary of essential operating information (I, U, f, P, E, THD, circuit breaker On/Off).

Access to detailed information

- "Metering" can be used to display the measurement data (I, U-V, f, P, Q, S, E, THD, PF) with the corresponding min/max values.
- Alarms displays the trip history.
- Services provides access to the operation counters, energy and maximeter reset function, maintenance indicators, identification of modules connected to the internal bus and FDM128 internal settings (language, contrast, etc.).

MicroLogic measurement capabilities come into full play with the FDM128 switchboard display. It connects to Ethernet communication via RJ45 port and displays MicroLogic information. The result is a true integrated unit combining a circuit breaker and a Power Meter. Additional operating assistance functions can also be displayed.



FDM128 display.



Surface mount accessory.



FDM128 display.

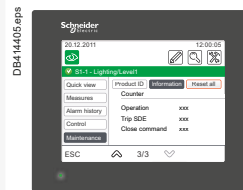

Product identification.

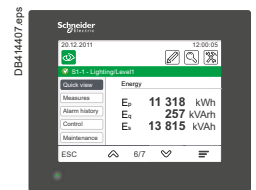

Metering: meter.

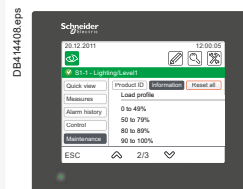

Services.

FDM121 Switchboard Display

MicroLogic measurement capabilities come into full play with the FDM121 switchboard display. It connects to COM option (BCM ULP) via a breaker ULP cord and displays MicroLogic information. The result is a true integrated unit combining a circuit breaker and a Power Meter. Additional operating assistance functions can also be displayed.

FDM121

An FDM121 switchboard display unit can be connected to a ULP IMU using a prefabricated cord to display all measurements, alarms, histories and event tables, maintenance indicators, management of installed devices on a screen. The result is a veritable 96 x 96 mm Power Meter.

The FDM121 display unit requires a 24 V DC power supply.

The FDM121 is a switchboard display unit that can be integrated in the ComPacT NSX100 to 630 A, PowerPacT H/J/L/P/R, ComPacT NS or MasterPact systems. It uses the sensors and processing capacity of the MicroLogic trip unit. It is easy to use and requires no special software or settings. It is immediately operational when connected to the ComPacT NSX by a simple cord.

Also, it provides monitoring and control with the use of the I/O application module, the motor mechanism module, or the Breaker Status module.

The FDM121 is a large display, but requires very little depth. The anti-glare graphic screen is backlit for very easy reading even under poor ambient lighting and at sharp angles.

Display of MicroLogic Measurements and Alarms

The FDM121 is intended to display MicroLogic 5/6 measurements, alarms and operating information. It cannot be used to modify the protection settings.

Measurements may be easily accessed via a menu. All user-defined alarms are automatically displayed. The display mode depends on the priority level selected during alarm set-up:

- High priority: a pop-up window displays the time-stamped description of the alarm and the orange LED flashes
- Medium priority: the orange "Alarm" LED goes steady on
- Low priority: no display on the screen.

All faults resulting in a trip automatically produce a high-priority alarm, without any special settings required. In all cases, the alarm history is updated. MicroLogic saves the information in its non-volatile memory in the event of an FDM121 power failure.

Status Indications and Remote Control

When the circuit breaker is equipped with the Breaker Status Module, the FDM121 display can also be used to view circuit breaker status conditions:

- O/F: ON/OFF
- SD: trip indication
- SDE: Fault-trip indication (overload, short-circuit, ground fault).

When the circuit breaker system is equipped with the I/O Application module, the FDM121 can monitor and control:

- Cradle management
- Circuit breaker operation
- Light and load control
- Custom application.

When the circuit breaker system is equipped with the motor mechanism module, the FDM121 offers remote closing and opening control.

Main Characteristics

- 96 x 96 x 30 mm screen requiring 10 mm behind the door (or 20 mm when the 24 V power supply connector is used).
- White backlighting.
- Wide viewing angle: vertical $\pm 60^\circ$, horizontal $\pm 30^\circ$.
- High resolution: excellent reading of graphic symbols.
- Alarm LED: flashing orange for alarm pick-up, steady orange after operator reset if alarm condition persists.
- Operating temperature range -10°C to $+55^\circ\text{C}$.
- CE/UL/CSA marking (pending).
- 24 V DC power supply, with tolerances 24 V -20% (19.2 V) to 24 V $+10\%$ (26.4 V).
When the FDM121 is connected to the communication network, the 24 V DC can be supplied by the communication system wiring system.
- Consumption 40 mA.

Mounting

The FDM121 is easily installed in a switchboard.

- Standard door cut-out 92 x 92 mm.
- Attached using clips.

To avoid a cut-out in the door, an accessory is available for surface mounting by drilling only two 22 mm diameter holes.

The FDM121 degree of protection is IP54 in front. IP54 is maintained after switchboard mounting by using the supplied gasket during installation.

Connection

The FDM121 is equipped with:

- A 24 V DC terminal block:
 - Plug-in type with 2 wire inputs per point for easy daisy-chaining
 - Power supply range of 24 V DC -20% (19.2 V) to 24 V DC $+10\%$ (26.4 V).

A 24 V DC type auxiliary power supply must be connected to a single point on the ULP system. The FDM121 display unit has a 2-point screw connector on the rear panel of the module for this purpose. The ULP module to which the auxiliary power supply is connected distributes the supply via the ULP cable to all the ULP modules connected to the system and therefore also to MicroLogic.

D

PB119233.eps



FDM121 display

PB103807_392.eps



Surface mount accessory

PB119235.eps



Connection with FDM121 display unit

Smart Panel Integration FDM121 Switchboard Display

- Two RJ45 jacks.
The MicroLogic connects to the internal communication terminal block on the ComPacT NSX via the NSX cord. Connection to one of the RJ45 connectors on the FDM121 automatically establishes communication between the MicroLogic and the FDM121 and supplies power to the MicroLogic measurement functions. When the second connector is not used, it must be fitted with a line terminator.

Navigation

Five buttons are used for intuitive and fast navigation. The "Context" button may be used to select the type of display (digital, bargraph, analogue). The user can select the display language (Chinese, English, French, German, Italian, Portuguese, Spanish, etc.).

Screens

Main menu

When powered up, the FDM121 screen automatically displays the ON/OFF status of the device.



When not in use, the screen is not backlit. Backlighting can be activated by pressing one of the buttons. It goes off after 3 minutes.

Fast access to essential information

- "Quick view" provides access to five screens that display a summary of essential operating information (I, U, f, P, E, THD, circuit breaker On/Off).

Access to detailed information

- "Metering" can be used to display the measurement data (I, U-V, f, P, Q, S, E, THD, PF) with the corresponding min/max values.
- Alarms displays active alarms and the alarm history.
- Services provides access to the operation counters, energy and maximeter reset
- Function, maintenance indicators, identification of modules connected to the internal bus and FDM121 internal settings (language, contrast, etc.).

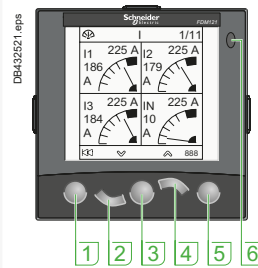

- 1 escape
- 2 down
- 3 ok
- 4 up
- 5 context
- 6 alarm LED

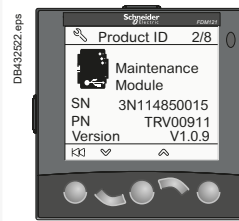

Product identification

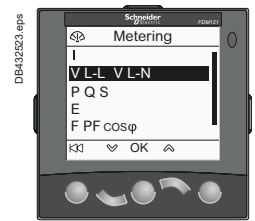

Metering: sub-menu

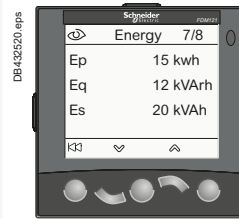

Metering: meter

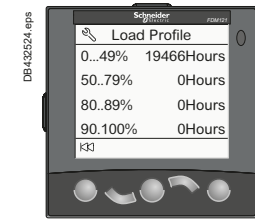

Services

Communication Components and FDM121 Connections

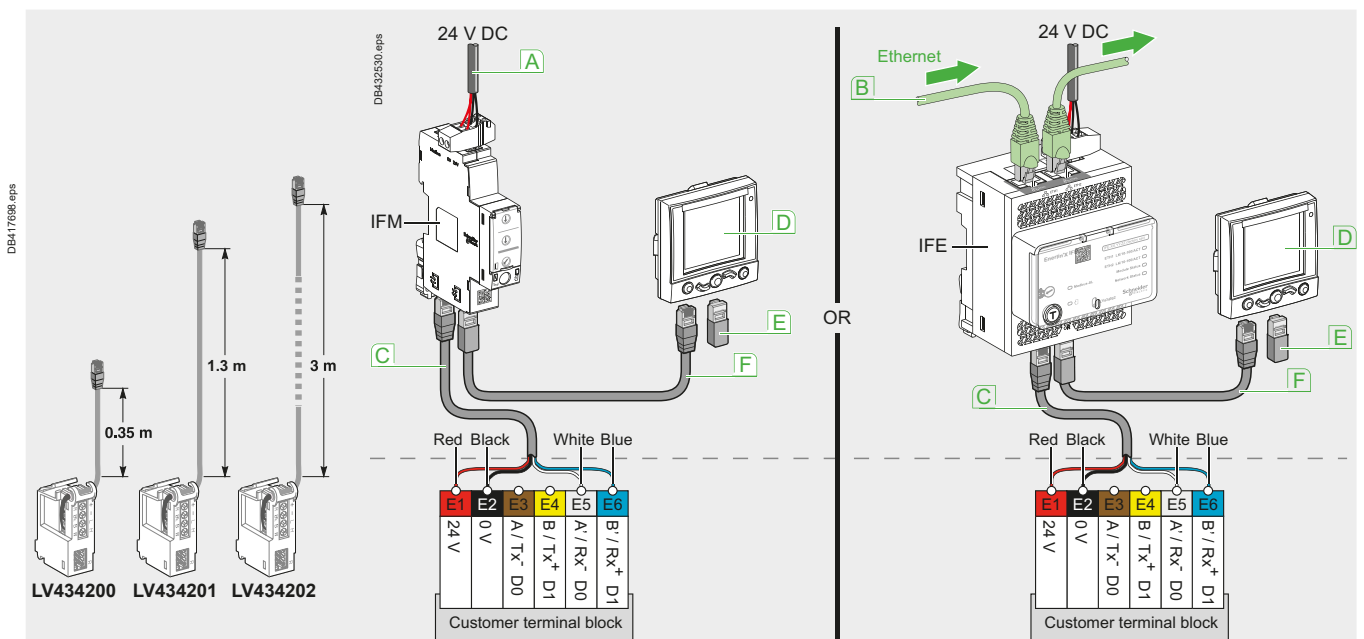

Connections

- ComPacT NSX is connected to the ULP devices (FDM121 display, IFM, IFE or I/O) unit via the NSX cord.
 - Cord available in three lengths: 0.35 m, 1.3 m and 3 m.
 - ULP lengths up to 10 m possible using extensions.

- A Modbus network
- B Ethernet network
- C NSX cord
- D FDM121 display
- E ULP termination
- F ULP cable

Customer Engineering Tool: EcoStruxure Power Commission Software

EcoStruxure Power Commission Experience

Project Lifecycle

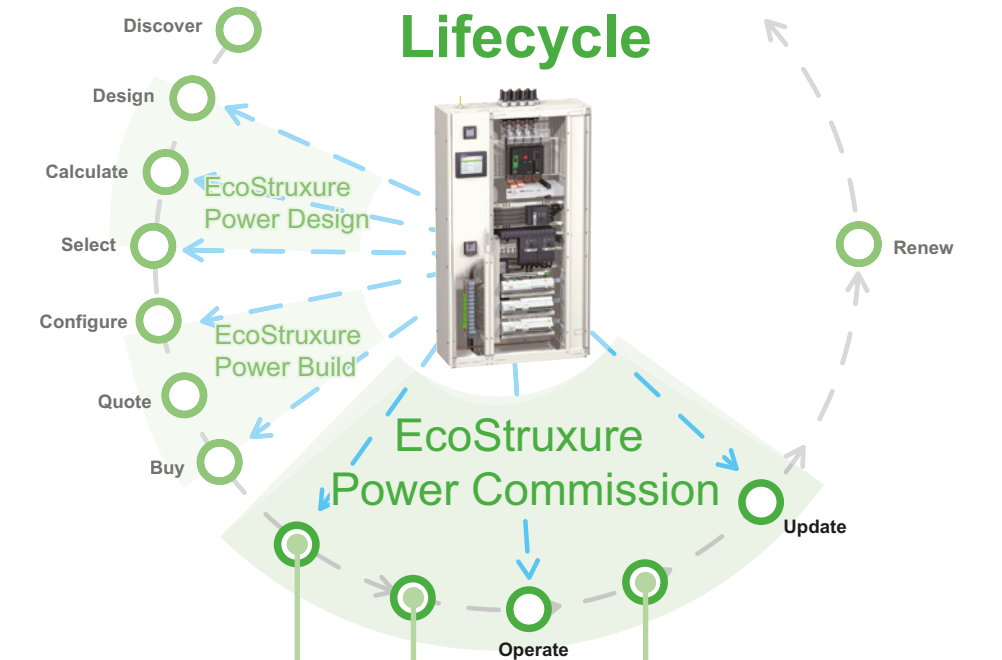

Key Features

Build

I want to test & deliver a “ready to commission” panel

- Device Discovery
- Switchboard setting & testing
- Communication Test & Reports
- Save my project & reports

Commission

I want to “shorten” my commissioning time

- Device Discovery
- Multi Device Configuration
- Communication Test & Reports
- Save my project & reports

Maintain

I want to ensure “continuity” of services in “safe conditions”

- Settings consistency check
- Firmware upgrade
- Standard Diagnostic data
- Save my project & reports

Build



Panel Builders

Simple & Easy Software to Set up and Test a Panelboard with Smart Phones

Commission



Electrical Contractors & System Integrator

Shorten Commissioning Time and Speed up SAT Delivery with Easy-to-Use Software

Maintain



Facility Managers

Software to Track Installation Changes & Diagnostic Features for Preventive Maintenance

D

Smart Panel Integration Customer Engineering Tool: EcoStruxure Power Commission Software

Operation and Maintenance

- Devices monitoring and control.
- Measurement parameter logs.
- Log reports.
- Download of current devices settings, compare with previous settings saved In EcoStruxure Power Commission.
- Firmware upgrade and compatibility matrix.

Compatibility

Devices

Configuration of below devices through the range of Enerlin'X interfaces devices.

- Circuit breakers: MasterPact MTZ, ComPact NSX ranges.
- Circuit breakers and control components.

EcoStruxure Power Commission software for PC

- Compatible with Windows 10.

Example of EcoStruxure Power Commission Win

Browsing tabs

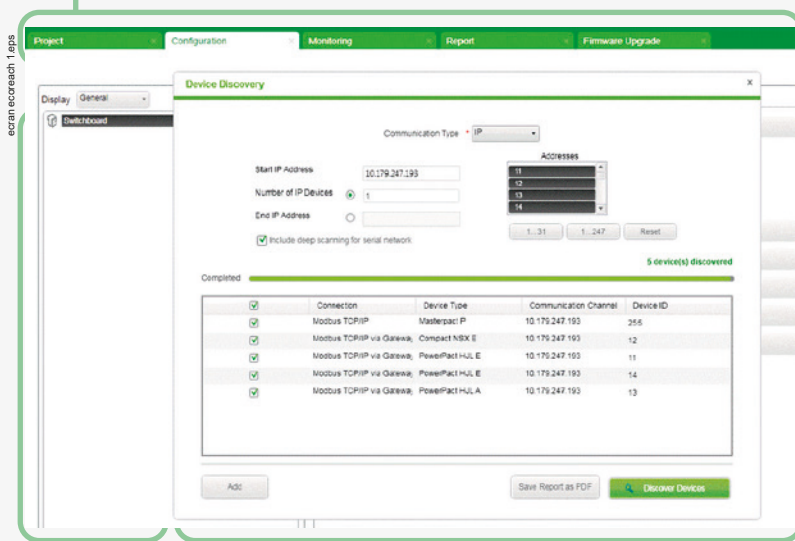

Smart Panels architecture

Contextual window, for monitoring, settings...

Key Features

- **Device Discovery**
EcoStruxure Power Commission helps the user to discover the communicating devices in a switchboard either through Ethernet or a serial network. Once the devices in the switchboard are discovered, the user can add those devices to the project area.
- **Communication Test**
When a user has installed communicating devices in a switchboard, EcoStruxure Power Commission offers the capability to test the communication network. Once a communication test is done, the user can generate a time stamped communication test report.
- **Reports**
EcoStruxure Power Commission offers the following reports to the users
- **Firmware Upgrade**
EcoStruxure Power Commission offers the compatibility check and firmware upgrade for the following devices.





Switchboard Integration

ComPacT NSX & NSXm

Operating and Installation Conditions	E-4
Safety Clearances and Minimum Distances	E-10
Voltage Release Wiring Rules	E-12
Power Loss/Resistance.....	E-13

ComPacT NSX Temperature Derating

Equipped with Thermal-Magnetic Trip Units	E-14
Equipped with Electronic Trip Units.....	E-16

ComPacT NSX Installation in Switchboards

Safety Clearances and Minimum Distances	E-18
Installation Example.....	E-19
Control Wiring.....	E-20

Power Supplies.....E-21

ComPacT NSX Power Loss/ Resistance

Equipped with Thermal-Magnetic Trip Units	E-23
Equipped with Electronic Trip Units.....	E-24



Other Chapters	
Select Circuit Breakers and Switch-Disconnectors	A-1
Select Protection	B-1
Customize Circuit Breakers with Accessories.....	C-1
Smart Panel Integration	D-1
Catalog Numbers	F-1
Glossary	G-1
Additional Characteristics.....	H-1

Switchboard Integration

ComPacT NSXm Dimensions and Mounting

Circuit Breaker and Switch-DisconnecterE-25

ComPacT NSX Dimensions and Mounting

ComPacT NSX100 to NSX250 Fixed Version, 1P-2PE-34

ComPacT NSX100 to 630 Fixed VersionE-36

ComPacT NSX100 to 630 VigiPacT Add-on Fixed VersionE-37

ComPacT NSX100 to 630 Plug-in Version.....E-38

ComPacT NSX100 to 630 Withdrawable VersionE-40

ComPacT NSX100 to 630 VigiPacT Add-on Plug-in and
Withdrawable Versions.....E-42

Visu Function for ComPacT NSX100 to 250 Fixed VersionE-43

Visu Function for ComPacT NSX400/630 Fixed VersionE-44

Motor Mechanism Module for ComPacT NSX100 to 630E-45

Direct Rotary Handle for ComPacT NSX100 to 630.....E-46

MCC and CNOMO Type Direct Rotary Handles for ComPacT
NSX100 to 630 Fixed VersionE-47

Extended Rotary Handle for ComPacT NSX100 to 630.....E-48

Indication and Measurement Modules for ComPacT NSX100
to 630 Fixed Version.....E-49

One-Piece Spreader for ComPacT NSX100 to 250 Fixed VersionE-50

External ModulesE-51

FDM121 Switchboard DisplayE-52

FDM128 Switchboard DisplayE-53

ComPacT NSX Front-Panel Accessories

ComPacT NSX100 to 630E-54

ComPacT NSX Front-Panel Cutouts

ComPacT NSX100 to 630 Fixed VersionE-56

ComPacT NSX100 to 630 VigiPacT Add-on Fixed VersionE-58

ComPacT NSX100 to 630 Plug-in and Withdrawable Versions....E-60

ComPacT NSX100 to 630 VigiPacT Add-on Plug-in and
Withdrawable Versions.....E-61

Visu Function for ComPacT NSX100 to 630 Fixed VersionE-62

Motor Mechanism Module for ComPacT NSX100 to 630 with/without
VigiPacT Add-onE-63

Direct Rotary Handle for ComPacT NSX100 to 630 with/without
VigiPacT Add-onE-64

Other Chapters

Select Circuit Breakers and Switch-DisconnectorsA-1

Select ProtectionB-1

Customize Circuit Breakers with Accessories.....C-1

Smart Panel IntegrationD-1

Catalog NumbersF-1

GlossaryG-1

Additional Characteristics.....H-1

Switchboard Integration

ComPacT NSX Power Connections

ComPacT NSX100 to 630 with/without VigiPacT Add-on Fixed Version.....E-66

ComPacT NSX100 to 630 with/without VigiPacT Add-on Plug-in and Withdrawable VersionsE-70

Connection of Insulated Bars or Cables with Lugs to ComPacT NSX100 to 630 with/without VigiPacT Add-on.....E-74

Connection of Bare Cables to ComPacT NSX100 to 630 with/without VigiPacT Add-onE-75

ComPacT NSXm

AuxiliariesE-76

SDx Module for MicroLogic Vigi 4.1 (ELCB).....E-77

Communication.....E-78

ComPacT NSX

Fixed Circuit Breakers.....E-79

Plug-in/Withdrawable Circuit Breakers.....E-81

Motor MechanismE-83

SDx Module with MicroLogic.....E-85

SDTAM Module with MicroLogic ME-86

Communication.....E-87



Other Chapters	
Select Circuit Breakers and Switch-Disconnectors	A-1
Select Protection	B-1
Customize Circuit Breakers with Accessories.....	C-1
Smart Panel Integration	D-1
Catalog Numbers	F-1
Glossary	G-1
Additional Characteristics.....	H-1

ComPacT NSX & NSXm

Operating and Installation Conditions

ComPacT NSXm may be mounted vertically, horizontally or flat on their back or on their side without any derating of characteristics.



ComPacT NSXm



Fixed Circuit Breakers

ComPacT NSXm may be mounted vertically, horizontally or flat on their back or on their side without any derating of characteristics.

These devices can be mounted on a DIN rail using the integrated DIN rail mounting feature.

For backplate mounting, the devices are supplied with two mounting screws (M4), washers and nuts. These mounting screws can be inserted through mounting holes molded into the device case and threaded into the mounting enclosure, rails or plate.

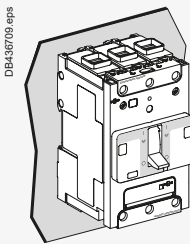

Mounting on a backplate

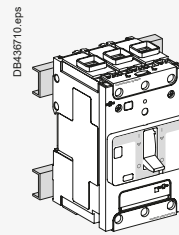

Mounting on rails

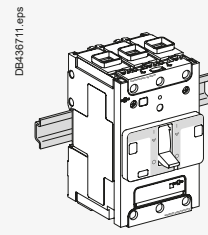

Mounting on DIN rail

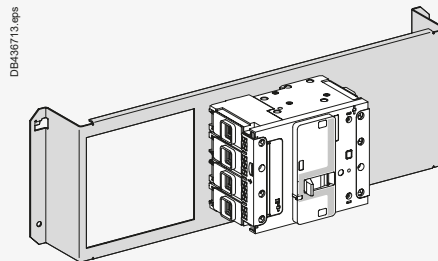

Mounting on a Prisma mounting plate

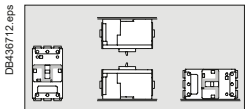

Fixed device installation positions



E

Switchboard Integration

ComPacT NSX & NSXm

Operating and Installation Conditions

ComPacT NSX circuit breakers may be installed horizontally, vertically or flat on their back, without derating performance levels.

There are three installation versions:

- Fixed
- Plug-in (on a base)
- Withdrawable (on a chassis).

For the last two, components must be added (base, chassis) to the fixed version. Many connection components are shared by the three versions.

Fixed Circuit Breakers

Fixed circuit breakers are designed for standard connection using bars or cables with lugs. Bare-cable connectors are available for connection to bare copper or aluminium cables.

For connection of large cables, a number of solutions with spreaders may be used for both cables with lugs or bare cables.

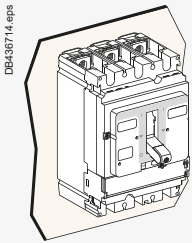

Mounting on a backplate

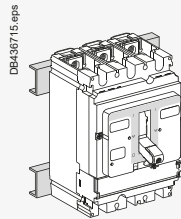

Mounting on rails

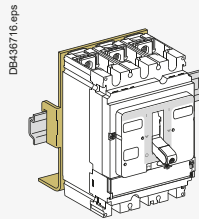

Mounting on DIN rail (with adapter)

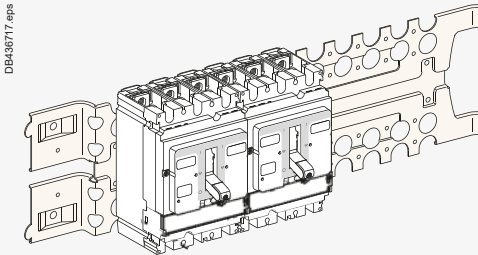

Mounting on a Prisma mounting plate

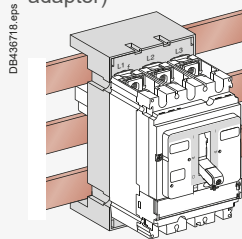

Mounting on busbars with an adapter



Fixed ComPacT NSX250

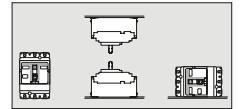

Fixed device installation positions



Plug-in ComPacT NSX250

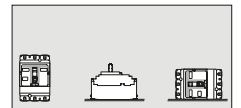

Withdrawable device installation positions



ComPacT NSX & NSXm

Operating and Installation Conditions

DB4-36800.ai

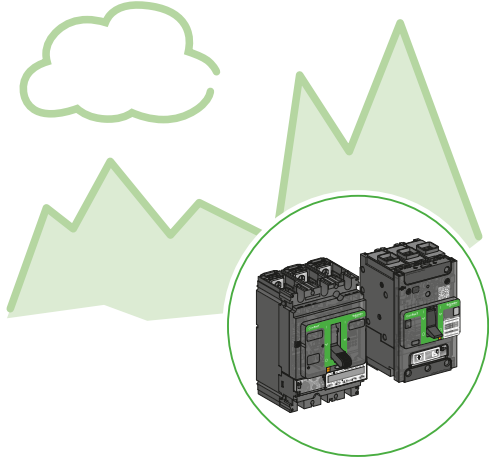

DB4-36801.ai

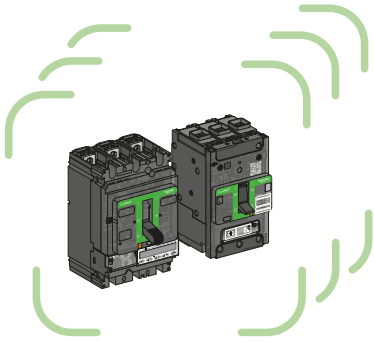

E

DB4-36802.ai

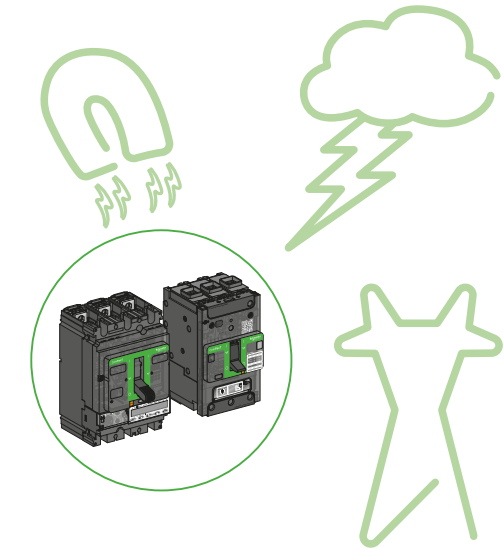

Altitude Derating

Altitude does not significantly affect the characteristics of ComPacT NSX and NSXm circuit breakers up to 2000 m. Above this altitude, it is necessary to take into account the decrease in the dielectric strength and cooling capacity of air. The following table gives the corrections to be applied for altitudes above 2000 m. The breaking capacities remain unchanged.

Altitude (m)		2000	3000	4000	5000
Impulse withstand voltage (kV)		8	7.1	6.4	5.6
Insulation voltage (V)	Ui	800	710	635 ^[1]	560
for ELCB ^[3]	Ui	500	445	400	350
Maximum operating voltage (V)	Ue	1000	886	790	696
for NSX400K					
Maximum operational voltage (V)	Ue	690	690	635 ^[1]	560
for ELCB ^[3]	Ue	440	440	400	350
Average current capacity (A) at 40 °C	In x	1.0	0.98 ^[2]	0.96	0.94

Vibrations

ComPacT NSX and NSXm devices resist mechanical vibrations. They meet IEC 60068-2-6:

- 2.0 to 13.2 Hz and amplitude ±1 mm
- 13.2 to 100 Hz acceleration ±0.7 g.

Excessive vibration may cause tripping, breaks in connections or damage to mechanical parts.

Electromagnetic Disturbances

ComPacT NSX and NSXm devices are protected against:

- Overvoltages caused by circuit switching
- Overvoltages caused by an atmospheric disturbances or by a distribution-system outage (e.g. failure of a lighting system)
- Devices emitting radio waves (radios, walkie-talkies, radar, etc.)
- Electrostatic discharges produced directly by users.

ComPacT NSX and NSXm devices have successfully passed the electromagnetic-compatibility tests (EMC) defined by the international standards listed [page A-15](#).

These tests ensure that:

- No nuisance tripping occurs
- Tripping times are respected.

[1] 640 for ComPacT NSX.

[2] 0.99 for ComPacT NSX.

[3] Earth Leakage Circuit Breaker.



Switchboard Integration

ComPacT NSX & NSXm

Operating and Installation Conditions

Protection Degree

Protection degree of the product, according to IEC 60529, depends of its configuration:

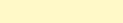
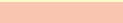
Colors	Definition
	IP54/65: side/front extended rotary handle
	IP40: front cover, side, back, long terminal shield, direct rotary handle
	IP20: power connection cover
	may be IP20 or less depending of the kind of power connections and cable size used

Power Supply from the Top or Bottom

ComPacT NSXm circuit breakers can be supplied from either the top or the bottom, even when equipped with a MicroLogic Vigi 4.1 with integrated earth leakage protection, without any reduction in performance. This capability facilitates connection when installed in a switchboard.

All connection and insulation accessories can be used on circuit breakers supplied either from the top or bottom.

Power Supply from the Top or Bottom ^[1]

ComPacT NSX circuit breakers can be supplied from either the top or the bottom, even when equipped with a VigiPacT add-on, without any reduction in performance. This capability facilitates connection when installed in a switchboard.

All connection and insulation accessories can be used on circuit breakers supplied either from the top or bottom.

[1] All R, HB1, and HB2 circuit breakers are restricted for use as line-load connection. They can not have power fed into the bottom of the circuit breaker. They will be marked with Line and Load markings.

Weight

The table below presents the weights (in kg) of the circuit breakers and the main accessories, which must be summed to obtain the total weight of complete configurations. The values are valid for all performance categories.

Type of device	Circuit breakers	Base	Chassis	VigiPacT add-on	Visu module	Motor mech.	
NSX100	3P/3D	2.05	0.8	2.2	0.87	2	1.2
	4P/4D	2.4	1.05	2.2	1.13	2.2	1.2
NSX160	3P/3D	2.2	0.8	2.2	0.87	2	1.2
	4P/4D	2.58	1.05	2.2	1.13	2.2	1.2
NSX250	3P/3D	2.4	0.8	2.2	0.87	2	1.2
	4P/4D	2.78	1.05	2.2	1.13	2.2	1.2
NSX400/630	3P/3D	6.19	2.4	2.2	2.8	4.6	2.8
	4P/4D	8.13	2.8	2.2	3	4.9	2.8

Compact™ NSXm Features Integrated Earth Leakage Protection



Compact™ NSXm Circuit Breaker Featuring Insulation Accessories

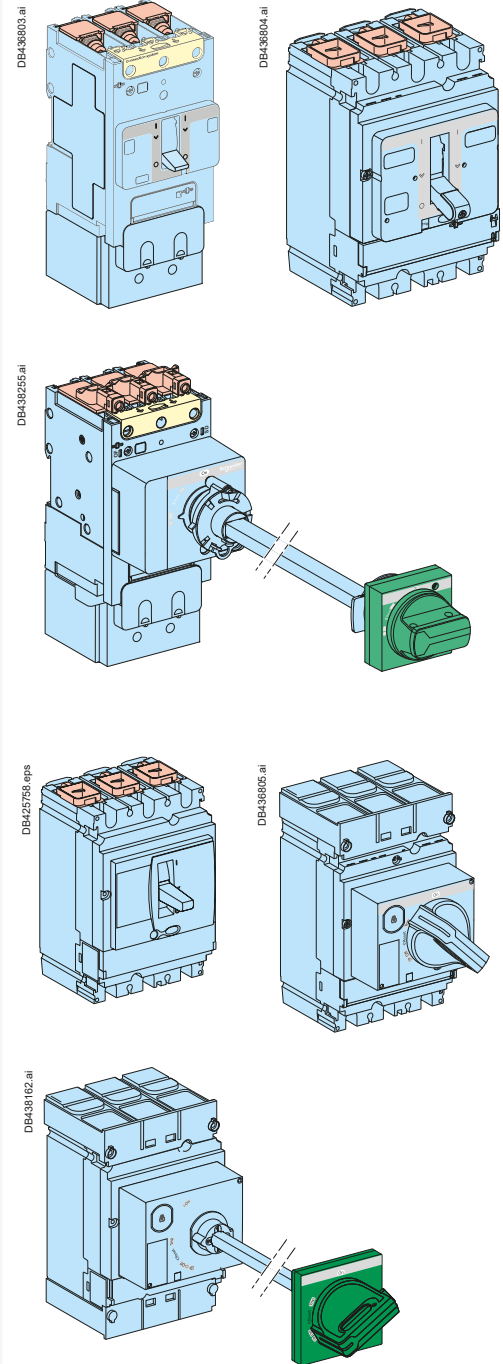

ComPacT NSXm

Operating and Installation Conditions

Derating and Correction Factor Depending of Temperature

The overload protection is calibrated at 40 °C in the lab. This means that when the ambient temperature is less or greater than 40 °C, the Ir protection pick-up is slightly modified.

Choosing the Right Rating Depending on the Temperature:

Over the reference temperature of 40 °C, the circuit breaker has to be derated following the table below:

Temperature derating for thermal-magnetic (TM-D) NSXm at In

Temperature °C						
40	45	50	55	60	65	70
Rating (A) In						
16	16	15	15	14	14	13
25	24	24	23	23	22	21
32	31	30	30	29	28	27
40	39	38	37	36	34	33
50	49	48	46	45	44	42
63	61	60	58	56	54	53
80	77	73	70	67	64	60
100	96	94	90	87	83	80
125	120	117	113	109	104	100
160	155	149	144	139	133	126

Temperature derating for NSXm with MicroLogic Vigi 4.1 at In

Temperature °C						
40	45	50	55	60	65	70
Rating (A) In						
25	25	25	25	25	25	25
50	50	50	50	50	50	50
100	100	100	100	100	100	100
160	155	150	145	140	135	130

Doing the Setting or Calculating the Tripping Time for a Given Temperature:

After having determine the corrected ratio I/I_n , the tripping time at 40 °C is defined with the tripping curves (see pages H-2 to H-3).

To obtain the right setting or the tripping time at a different temperature, the ratio I/I_n has to be corrected with the correction factor below:

Correction factor table for thermal magnetic (TM-D) NSXm to determine setting or tripping time at I_n													
Rating (A) I_n	Temperature °C												
	10	15	20	25	30	35	40	45	50	55	60	65	70
16	1.16	1.13	1.11	1.08	1.05	1.03	1.00	0.97	0.94	0.91	0.88	0.85	0.81
25	1.13	1.11	1.09	1.07	1.05	1.02	1.00	0.98	0.95	0.93	0.90	0.88	0.85
32	1.14	1.11	1.09	1.07	1.05	1.02	1.00	0.98	0.95	0.93	0.90	0.87	0.84
40	1.15	1.12	1.10	1.08	1.05	1.03	1.00	0.97	0.95	0.92	0.89	0.86	0.83
50	1.13	1.11	1.09	1.07	1.05	1.02	1.00	0.98	0.95	0.93	0.90	0.87	0.85
63	1.14	1.12	1.10	1.07	1.05	1.02	1.00	0.97	0.95	0.92	0.89	0.86	0.83
80	1.21	1.18	1.14	1.11	1.07	1.04	1.00	0.96	0.92	0.88	0.83	0.80	0.75
100	1.18	1.16	1.12	1.10	1.06	1.04	1.00	0.96	0.94	0.90	0.87	0.83	0.80
125	1.17	1.14	1.11	1.08	1.06	1.03	1.00	0.96	0.93	0.90	0.87	0.84	0.80
160	1.17	1.15	1.12	1.09	1.06	1.03	1.00	0.97	0.93	0.90	0.87	0.83	0.79

Doing the right setting depending of the temperature:

Example: What is the setting to obtain a real I_r of 105 A, taking into account the temperature, for a ComPacT NSXm 125 A?

The necessary dial setting, in amperes, is shown below.

- At 40 °C, $I_r = 105/1 = 105$ A
- At 20 °C, $I_r = 105/1.11 = 95$ A
- At 60 °C, $I_r = 105/0.87 = 121$ A.

Calculating the tripping time at $I_r = I_n$ for a given temperature:

Example: What is the tripping time of a ComPacT NSXm 100A at $I_r = I_n$ for an overload of 500 A?

- At 40 °C, $I/I_r = 5$, tripping time is between 6 and 60 seconds
- At 20 °C, $I/I_r = 5/1.12 = 4.46$, tripping time is between 8 and 80 seconds
- At 60 °C, $I/I_r = 5/0.87 = 5.75$, tripping time is between 5 and 50 seconds

For $I_r = 0.7$ to $0.9 I_n$, additional correction factor need to be applied - please consult us.

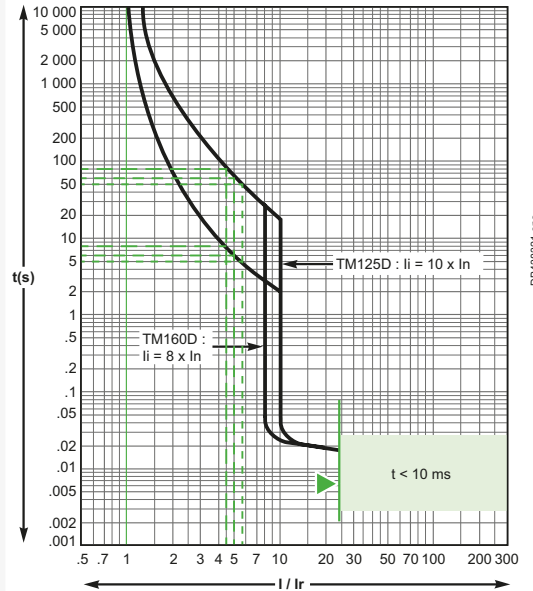

DB438321.eps



ComPacT NSXm

Safety Clearances and Minimum Distances

General Rules

When installing a circuit breaker, minimum distances (safety clearances) must be maintained between the device and panels, bars and other protection devices installed nearby. These distances, which depend on the ultimate breaking capacity, are defined by tests carried out in accordance with standard IEC 60947-2.

If installation conformity is not checked by type tests, it is also necessary to:

- Use insulated bars for circuit-breaker connections
- Segregate the busbars using insulating screens.

For ComPacT NSXm devices, terminal shields and interphase barriers are recommended and may be mandatory depending on the kind of power connections of the device and type of installation.

Power Connections

The table below indicates the rules to be respected for ComPacT NSXm devices to ensure insulation of live parts for the various types of connection.



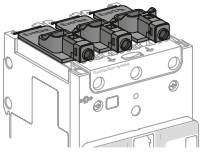
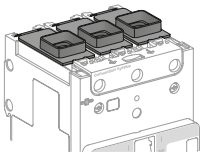
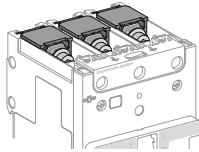

Connection accessories such as crimp lugs, power distribution connectors, and spreaders are supplied with interphase barriers.

Long terminal shields provide a degree of protection of IP40 (ingress) and IK07 (mechanical impact).

ComPacT NSXm: Rules to Be Respected to Ensure Insulation of Live Parts

	EverLink connector with or without control wire terminal	Mechanical lug connector	Compression lug/ busbar connector
	 DB448721.eps	 DB448722.eps	 DB448723.eps

Insulation Accessory Options Per Conductor Type

Type of conductor	No insulating accessory	Interphase barriers	Long terminal shield	No insulating accessory	Interphase barriers	Long terminal shield	No insulating accessory	Interphase barriers	Long terminal shield
Cables  DB419248.eps	Possible	-	-	Possible	Possible	Possible	-	-	-
Insulated bars  DB419249.eps	-	-	-	-	-	-	Possible [2]	Possible	Possible
Cables + crimp lugs  DB419250.eps	-	-	-	-	-	-	Forbidden	Mandatory [3]	Possible [1]
Cables + crimp lugs with heat-shrinkable sheath  DB419251.eps	-	-	-	-	-	-	Possible [2]	Possible	Possible
Extension terminals: spreader  DB419252.eps	-	-	-	-	-	-	Forbidden	Mandatory [4]	-

[1] Instead of phase barriers.

[2] Safety air clearance of 8 mm has to be respected between live parts.

[3] When > 5 mm clearance between devices Interphase barriers are mandatory otherwise for < 5 mm Long terminal shields are mandatory.

[4] When > 5 mm clearance between devices Interphase barriers are mandatory otherwise > 5 mm clearance between devices is forbidden.

Note: For uninsulated bar connections, please consult us.

E

IEC Standard

Minimum Safety Clearances

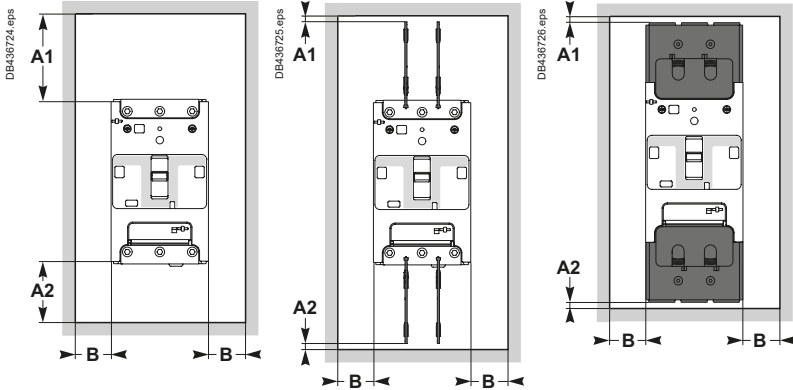

Operating voltage	Clearance (mm)						
	Between devices	Between device and sheet metal			Bare sheet metal		
		Painted sheet metal	A2	B	A1	A2	B
$U \leq 690 \text{ V}$		A1	A2	B	A1	A2	B
for devices equipped with:							
no accessories	0	30 mm	5 mm	0	40 mm	5 mm	5 mm
interphase barriers ^[1]	0	0	0	0	0	0	5 mm
long terminal shields	0	0	0	0	0	0	5 mm

[1] 20 mm clearance when using spreaders and 5mm clearance when using crimp lugs between devices is mandatory.

Minimum Safety Clearances to Bare Busbars

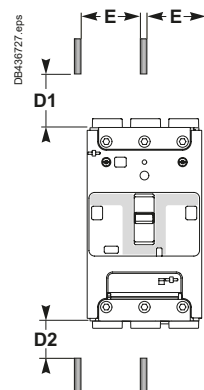

Operating voltage	Clearances to live bare busbars ^[2]			
	Spacing $E \leq 60 \text{ mm}$		Spacing $E > 60 \text{ mm}$	
	D1	D2	D1	D2
$U \leq 690 \text{ V}$	200 mm	100 mm	120 mm	60 mm

[2] These clearances can be reduced for special installations as long as the configuration is checked by tests.

Compression Lug Safety Clearance

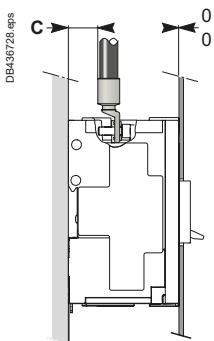

An insulating screen or long terminal shield is required if $C < 8 \text{ mm}$.



ComPacT NSXm

Voltage Release Wiring Rules

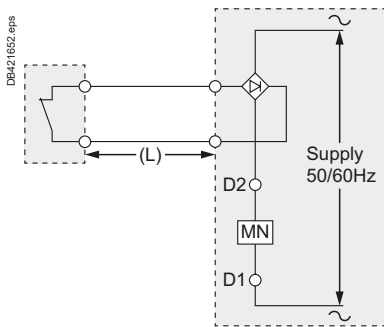
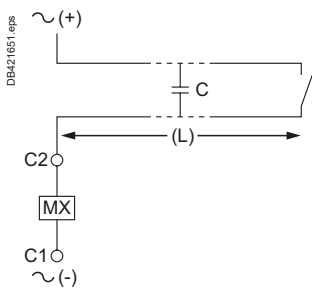
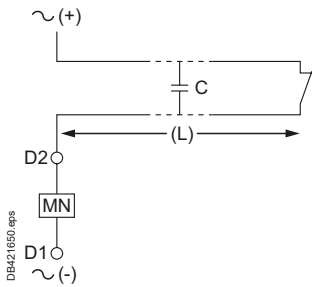

Shunt Trip (MX) and Undervoltage Release (MN)

Recommended maximum cable lengths

In certain circumstances, high cable capacitance due to an excessive cable length could prevent an undervoltage release MN from dropping out resulting in safety issues. In case of a shunt trip MX, an untimely trip may occur due to capacitive current leak.

To avoid these dysfunction due to cable capacitance C, the maximum cable length (L) is defined by the following table for a 1.5 mm² cable.

Power supply voltage (Un)	Maximum cable length undervoltage trip (MN) [1]	Shunt trip (MX) [1]
24 V AC	1 243 m	3 653 m
24 V DC	unlimited	> 3653 m
48 V AC	583 m	1 667 m
48 V DC	unlimited	> 1667 m
110...130 V AC	126 m	913 m
110...130 V DC	unlimited	> 913 m
208-240 V AC	109 m	160 m
250 V DC	unlimited	> 160 m
277 V AC	98 m	120 m
380-415 V AC	86 m	80 m
440-480 V AC	56 m	67 m

[1] Make sure auxiliaries supply voltage is within working range (0.85 Un mini...1.1 Un maxi).

If a longer cable length is required, several solutions are possible to counteract excessive cable capacitance:

- Use DC operated auxiliaries
- Use lower control voltage (make sure auxiliaries supply voltage is within working range: 0.85 Un minimum...1.1 Un maximum)
- If high voltage and long control cables are required for an AC undervoltage release (MN), add a rectifier bridge (ref LV426899 – DIN rail compatible) in the control circuit. It will prevent drop out problems but increase operating time.

Electrical Characteristics of MN/MX

Characteristics			AC	DC
Rated voltage (V)			24, 48, 110...130, 208...240, 277, 380...415, 440...480	24, 48, 125, 250
Power requirements	MX	Pickup (< 50 ms)	< 6 VA	< 10 W
		Seal-in	< 4 VA	< 1 W
	MN		< 7 VA	< 2 W
Clearing time (ms)			< 50	< 50
Operating range			up to 1.1 Un	

ComPacT NSXm thermal power loss values are used to calculate total temperature rise in the switchboard in which the circuit breakers are installed.

The values indicated in the tables below are typical values for a device at full rated load and 50/60 Hz.

Power loss per pole (P/pole) in Watts (W)

The value indicated is the power loss at I_n , 50/60 Hz, for a three-pole or four-pole circuit breaker. Measurement and calculation of power loss are carried out in compliance with the recommendations of Annex G of standard IEC 60947-2.

Resistance per pole (R/pole) in milliohms (mΩ)

The value of the resistance per pole is provided as a general indication for a new device.

The value of the contact resistance is determined on the basis of the measured voltage drop, in accordance with the manufacturer's test procedure.

Note: This measurement is not sufficient to determine the quality of the contacts, i.e. the capacity of the circuit breaker to carry its rated current.

Calculation of total power loss

Total power loss at full rated load and 50/60 Hz is equal to power losses per pole multiplied by the number of poles (3 or 4).

ComPacT NSXm with TM-D

Rating (A)	R total/pole (mΩ)	P/Pole (W)
16	8.87	2.3
25	4.50	2.8
32	3.10	3.3
40	2.30	3.8
50	1.85	4.6
63	1.44	5.7
80	0.90	5.8
100	0.75	7.5
125	0.59	9.3
160	0.53	13.7

ComPacT NSXm with MicroLogic Vigi 4.1

Rating (A)	R total/pole (mΩ)	P/Pole (W)
25	2.44	1.5
50	0.48	1.2
100	0.48	4.8
160	0.48	12.3



ComPacT NSX Temperature Derating Equipped with Thermal-Magnetic Trip Units

When thermal-magnetic trip units are used at ambient temperatures other than 40 °C, the Ir pick-up is modified.

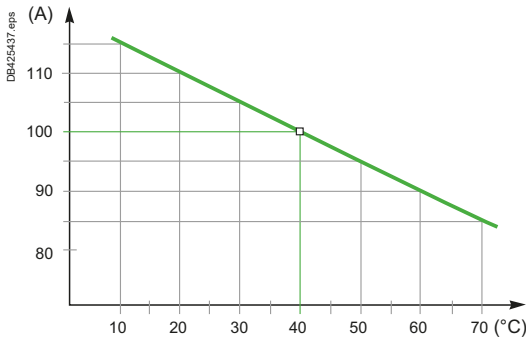

Temperature derating curve for ComPacT NSX100

Derating and Correction Factor Depending of Temperature

The overload protection is calibrated at 40 °C in the lab. This means that when the ambient temperature is less or greater than 40 °C, the Ir protection pick-up is slightly modified.

Choosing the Right Rating Depending of the Temperature:

Over the reference temperature of 40 °C, the circuit breaker has to be derated following the table below:

Temperature derating for thermal-magnetic (TM-D) NSX at In						
Temperature °C						
40	45	50	55	60	65	70
Rating (A) In						
16	15.6	15.2	14.8	14.5	14	13.8
25	24.5	24	23.5	23	22	21
32	31.3	30.5	30	29.5	29	28.5
40	39	38	37	36	35	34
50	49	48	47	46	45	44
63	61.5	60	58	57	55	54
80	78	76	74	72	70	68
100	97.5	95	92.5	90	87.5	85
125	122	119	116	113	109	106
160	156	152	148	144	140	136
200	195	190	185	180	175	170
250	244	238	231	225	219	213

Doing the Setting or Calculating the Tripping Time for a Given Temperature:

After having determine the corrected ratio I/In, the tripping time at 40 °C is defined with the tripping curves (see pages H-5 to H-7).

To obtain the right setting or the tripping time at a different temperature, the ratio I/In has to be corrected with the correction factor below:

Correction factor table for thermal magnetic (TM-D) NSX to determine setting or tripping time at In													
Rating (A) In	Temperature °C												
	10	15	20	25	30	35	40	45	50	55	60	65	70
16	1.15	1.17	1.13	1.13	1.06	1.04	1.00	0.98	0.95	0.93	0.91	0.88	0.86
25	1.15	1.12	1.10	1.08	1.05	1.02	1.00	0.98	0.96	0.94	0.92	0.88	0.84
32	1.15	1.13	1.10	1.07	1.05	1.03	1.00	0.98	0.95	0.94	0.92	0.91	0.89
40	1.15	1.13	1.10	1.08	1.05	1.03	1.00	0.98	0.95	0.93	0.9	0.88	0.85
50	1.15	1.12	1.10	1.08	1.05	1.02	1.00	0.98	0.96	0.94	0.92	0.90	0.88
63	1.14	1.13	1.10	1.08	1.05	1.03	1.00	0.98	0.95	0.92	0.90	0.87	0.86
80	1.15	1.13	1.10	1.08	1.05	1.03	1.00	0.98	0.95	0.93	0.90	0.88	0.85
100	1.15	1.13	1.10	1.08	1.05	1.03	1.00	0.98	0.95	0.93	0.90	0.88	0.85
125	1.15	1.128	1.10	1.07	1.05	1.02	1.00	0.98	0.95	0.93	0.90	0.87	0.85
160	1.15	1.125	1.10	1.08	1.05	1.03	1.00	0.98	0.95	0.93	0.90	0.88	0.85
200	1.15	1.125	1.10	1.08	1.05	1.03	1.00	0.98	0.95	0.93	0.90	0.88	0.85
250	1.15	1.124	1.11	1.08	1.05	1.02	1.00	1.63	0.95	0.92	0.90	0.88	0.85

For Ir = 0.7 to 0.9 In, additional correction factor need to be applied - please consult us.

E

ComPacT NSX Temperature Derating Equipped with Thermal-Magnetic Trip Units

Example 1. What is the tripping time of a ComPacT NSX100 equipped with a TM100D trip unit set to 100 A, for an overload $I = 500$ A? The overload I/I_r is calculated as a function of the temperature. Use the above values and the curve on page H-6 (shown on the left) to determine the corresponding time.

- At 40 °C, $I_r = 100$ A, $I/I_r = 5$ and the tripping time is between 6 and 60 seconds.
- At 20 °C, $I_r = 110$ A, $I/I_r = 4.54$ and the tripping time is between 8 and 80 seconds.
- At 60 °C, $I_r = 90$ A, $I/I_r = 5.55$ and the tripping time is between 5 and 50 seconds.

Example 2. What is the setting to obtain a real I_r of 210 A, taking into account the temperature, for a ComPacT NSX250 equipped with a TM250D trip unit? The necessary dial setting, in amperes, is shown below.

- At 40 °C, $I_r = (210/250) \times 250$ A = 210 A
- At 20 °C, $I_r = (210/277) \times 250$ A = 189.5 A
- At 60 °C, $I_r = (210/225) \times 250$ A = 233 A

Additional Derating Coefficient for an Add-on Module

The values indicated in the previous tables are valid for **fixed** circuit breakers equipped with one of the following modules:

- VigiPacT add-on
- VigiPacT add-on alarm
- Current-transformer module.

They also apply for **plug-in or withdrawable** circuit breakers equipped with:

- Current-transformer module.

However, for **plug-in or withdrawable** circuit breakers equipped with a VigiPacT add-on or a VigiPacT add-on alarm, the coefficient 0.84 must be applied.

The table below sums up the situation for add-on modules.

Type of device	Circuit breaker	TM-D trip-unit rating	VigiPacT add-on or VigiPacT add-on alarm	Current transformer module, or PowerTag NSX
Fixed	NSX100	16 to 100	1	1
	NSX160 to 250	125 to 160		
	NSX250	200 to 250		
Plug-in or withdrawable	NSX100	16 to 100	0.84	
	NSX160	125 to 160		
	NSX250	200 to 250		

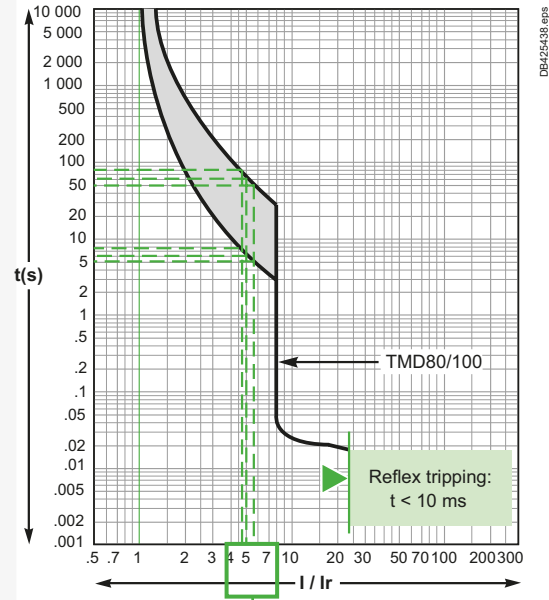

Example 1. Fault $I = 500$ A

I/I_r	4.5	5	5.5
T °C	20 °C	40 °C	60 °C
t min.	8 s	6 s	5 s
t max.	80 s	60 s	50 s

Thermal-protection curve with minimum and maximum values



ComPacT NSX Temperature Derating

Equipped with Electronic Trip Units

Changes in temperature do not affect measurements by electronic trip units.

- The built-in CT sensors with Rogowski toroids measure the current.
- The control electronics compare the value of the current to the settings defined For 40 °C.

Because temperature has no effect on the toroid measurements, the tripping thresholds do not need to be modified.

However, the temperature rise caused by the flow of current and the ambient temperature increase the temperature of the device. To avoid reaching the thermal withstand level of the equipment, it is necessary to limit the current flowing through the device, i.e. the maximum I_r setting as a function of the temperature.

ComPacT NSX100/160/250

The table below indicates the maximum long-time (LT) protection setting I_r (A) depending on the ambient temperature.

Type of device	Rating (A)	Temperature (°C)						
		40	45	50	55	60	65	70
NSX100/160								
Fixed, plug-in	100	no derating						
or withdrawable	160	no derating						
NSX250 + MicroLogic 2.2/5.2/6.2								
Fixed	250	250	250	250	245	237	230	225
Plug-in or withdr.	250	250	245	237	230	225	220	215
NSX250 + MicroLogic Vigi 4.2/7.2								
Fixed	250	250	250	245	237	230	225	218
Plug-in or withdr.	250	225	220	215	210	205	198	190

ComPacT NSX400 and 630

The table below indicates the maximum long-time (LT) protection setting I_r (A) depending on the ambient temperature.

Type of device	Rating (A)	Temperature (°C)						
		40	45	50	55	60	65	70
NSX400 + MicroLogic 2.3/5.3/6.3								
Fixed	400	400	400	400	390	380	370	360
Plug-in/withdr.	400	400	390	380	370	360	350	340
NSX400 + MicroLogic Vigi 4.3/ 7.3								
Fixed	400	400	400	390	380	370	360	350
Plug-in/withdr.	400	400	390	380	370	360	350	340
NSX630 + MicroLogic 2.3/5.3/6.3								
Fixed	630	630	615	600	585	570	550	535
Plug-in/withdr.	630	570	550	535	520	505	490	475
NSX630 + MicroLogic Vigi 4.3/7.3								
Fixed	630	570	555	540	530	515	500	485
Plug-in/withdr.	630	480	470	457	445	435	420	405

Example A fixed ComPacT NSX400 equipped with a MicroLogic can have a maximum I_r setting of:

- 400 A up to 50 °C
- 380 A up to 60 °C.

ComPacT NSX Temperature Derating Equipped with Electronic Trip Units

Additional Derating Coefficient for an Add-on Module

For **fixed** or **plug-in/withdrawable** circuit breakers, the addition of a:

- VigiPacT add-on
- VigiPacT add-on alarm
- Current-transformer module can modify the derating values.
Apply the coefficients shown below.

Derating of a ComPacT NSX equipped with a MicroLogic trip unit

Type of device	Circuit breaker	MicroLogic type	VigiPacT add-on or VigiPacT add-on alarm	PowerTag NSX	Coupling busbar	Current transformer	
Fixed	NSX100	2.2/5.2/6.2	1	1	1	1	
		4.2/7.2	-		1		
	NSX160	2.2/5.2/6.2	1		1		
		4.2/7.2	-		1		
	NSX250	2.2/5.2/6.2	1		1		
		4.2/7.2	-		0.95		
Plug-in or withdrawable	NSX100	2.2/5.2/6.2	1		-		
		4.2/7.2	-				
	NSX160	2.2/5.2/6.2	1				
		4.2/7.2	-				
	NSX250	2.2/5.2/6.2	0.86				
		4.2/7.2	-				
Fixed	NSX400	2.3/5.3/6.3	0.97	0.97	1	1	
		4.3/7.3	-		0.97		
	NSX630	2.3/5.3/6.3	0.9	0.9	1		
		4.3/7.3	-		0.9		
	Plug-in or withdrawable	NSX400	2.3/5.3/6.3	0.97	1		-
			4.3/7.3	-			
NSX630		2.3/5.3/6.3	0.9				
		4.3/7.3	-				

Note:

- Coupling busbar is forbidden with VigiPacT add-on.
- Current transformer is forbidden with VigiPacT add-on and coupling busbar.
- Coupling busbar is forbidden with withdrawable installation.
- To provide the Visu function, ComPacT NSX circuit breakers, with or without a VigiPacT add-on, are combined with INV switch-disconnectors.
Tripping values for the selected combination are indicated in the ComPacT INS/INV catalog.



ComPacT NSX Installation in Switchboards

Safety Clearances and Minimum Distances

General Rules

When installing a circuit breaker, minimum distances (safety clearances) must be maintained between the device and panels, bars and other protection devices installed nearby. These distances, which depend on the ultimate breaking capacity, are defined by tests carried out in accordance with standard IEC 60947-2. If installation conformity is not checked by type tests, it is also necessary to:

- Use insulated bars for circuit-breaker connections
- Segregate the busbars using insulating screens.

For ComPacT NSX100 to 630 devices, terminal shields and interphase barriers are recommended and may be mandatory depending on the operating voltage of the device and type of installation (fixed, withdrawable, etc.).

Power Connections

The table below indicates the rules to be respected for ComPacT NSX100 to 630 devices to ensure insulation of live parts for the various types of connection.

- Fixed devices with front connection (FC) or rear connection (RC).
- Plug-in or withdrawable devices.

Connection accessories such as crimp lugs, bare-cable connectors, terminal extensions (straight, right-angle, double-L and 45°) and spreaders are supplied with interphase barriers.

Long terminal shields provide a degree of protection of IP40 (ingress) and IK07 (mechanical impact).

ComPacT NSX100 to 630: Rules to Be Respected to Ensure Insulation of Live Parts

Type of connection		Fixed, front connection			Fixed, rear connection	Plug-in or withdrawable	
						On backplate 	Through panel
Possible, recommended or mandatory accessories:		No insulating accessory	Interphase barriers	Long terminal shields	Short terminal shields	Short terminal shields	Short terminal shields
With:							
operating voltage	type of conductor						
< 500 V	Insulated bars 	Possible	Possible	Possible	Recommended	Recommended	Mandatory
	Extension terminals Cables + crimp lugs 	No	Mandatory (supplied)	Possible (instead of ph. barriers)	Recommended	Recommended	Mandatory
	Bare cables + connectors 	Possible for cable connectors NSX100 to 250	Possible for cable connectors NSX100 to 250	Possible for cable connectors NSX100 to 250	Recommended	Recommended	Mandatory
≥ 500 V	Insulated bars 	No	No	Mandatory (use of short terminal shield possible)	Mandatory [2]	Mandatory [2]	Mandatory [2]
	Extension terminals Cables + crimp lugs 	No	No	Mandatory	Mandatory [2]	Mandatory [2]	Mandatory [2]
	Bare cables + connectors 	No	No	Mandatory	Mandatory [2]	Mandatory [2]	Mandatory [2]

[1] Long terminal shields, mandatory if the device is fixed through the door, whatever the voltage.

[2] LV433693 (3P) or LV433694 (4P) Short Terminal Shield are mandatory for R/HB1/HB2 400 A and 630 A performance.

ComPacT NSX Installation in Switchboards Installation Example

Safety Clearance

Minimum distance between two adjacent circuit breakers

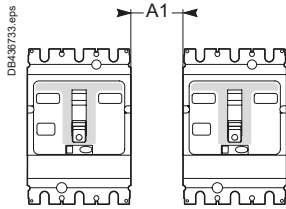

Minimum distance between circuit breaker and front or rear panels

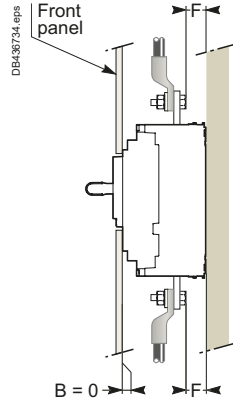

Bare or painted sheetmetal

Note: If $F < 8$ mm: an insulating screen or long terminal shield is mandatory (see page C-23).

> ComPacT NSX High Performance User Guide



DOCA0187EN

Minimum distance between circuit breaker and top, bottom or side panels

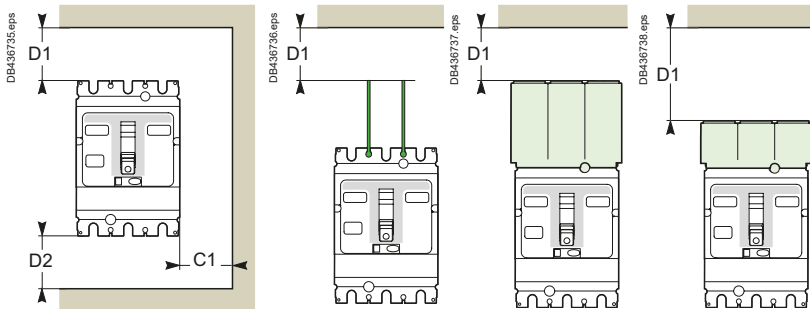

Devices without accessories

Devices with interphase barriers or long or short terminal shields

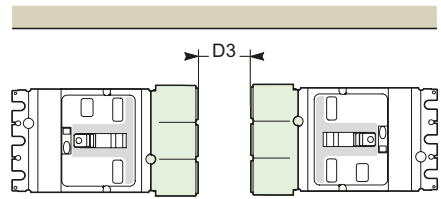

Short terminal shield rear connected

Minimum safety clearances for ComPacT NSX100 to 630

Operating voltage	Clearance (mm)							
	Between devices A1	Between device and sheetmetal						D3
		Between devices C1	Painted sheet metal		Bare sheet metal			
		C1	D1	D2	C1	D1	D2	
U ≤ 440 V								
for devices equipped with:								
■ No accessories	0	0	30	30	5	40	40	-
■ Short terminal shields	0	0	30	30	5	40	40	50
■ Interphase barriers	0	0	0	0	5	0	0	-
■ Long terminal shields	0	0	0	0	0	0	0	-
440 V < U ≤ 500 V								
for devices equipped with:								
■ Short terminal shields	0	0	30	30	10	40	40	50
■ Interphase barriers ^[1]	0	0	0	0	20	10	10	-
■ Long terminal shields ^[2]	0	0	0	0	10	10	10	-
U > 500 V								
for devices equipped with:								
■ Short terminal shields	0	10	50	50	20	100	100	50
■ Long terminal shields	0	10	30	30	20	40	40	-

[1] Only for NSX100 to 250.

[2] For all cases.

Clearances with Respect to Live Bare Busbars

Minimum clearances for ComPacT NSX100 to 630

Operating voltage	Clearances with respect to live bare busbars			
	spacing ≤ 60 mm		spacing > 60 mm	
	F1	F2	F1	F2
U < 440 V	350	350	80	80
440 V ≤ U ≤ 500 V	350	350	120	120
U > 500 V	prohibited: insulating screen required between device and busbars			

These clearances can be reduced for special installations as long as the configuration is checked by tests

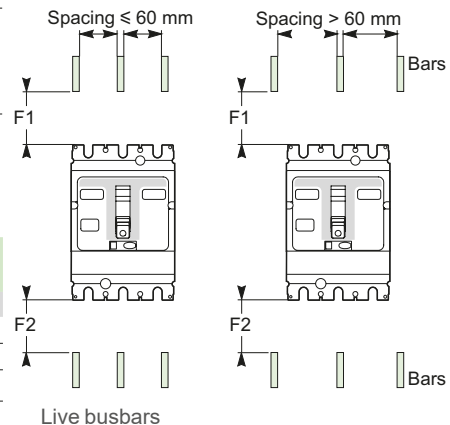

ComPacT NSX Control Wiring

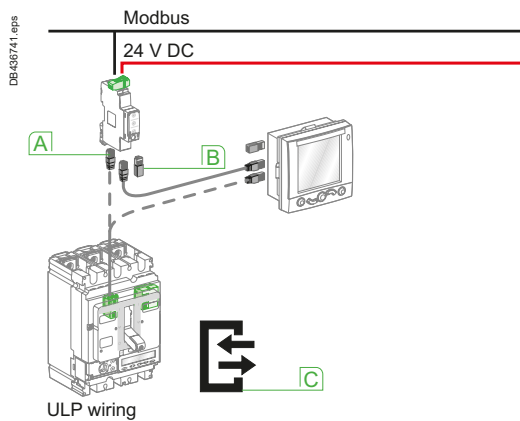
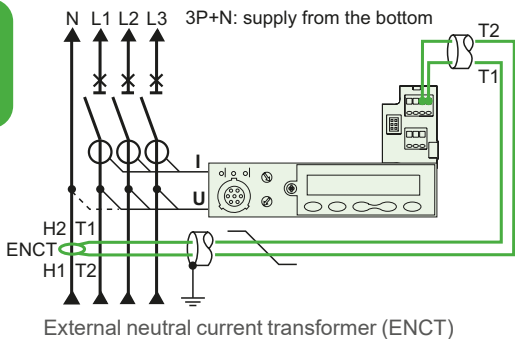
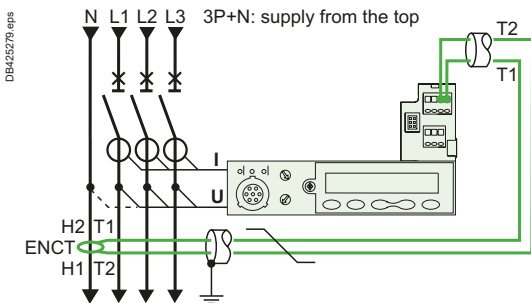
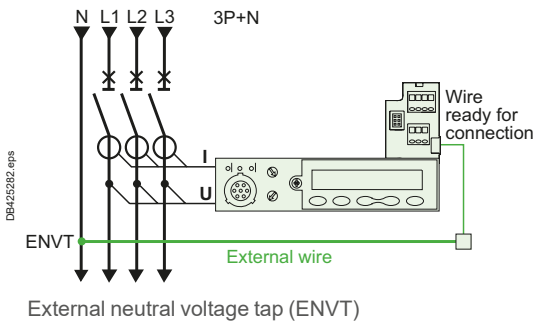

ULP connection system

- A** RJ45
- B** Line terminator
- C** ULP symbol

Remote Tripping by MN or MX Release

Power consumption is approximately:

- 30 VA for pick-up of the MN and MX releases
- 300 VA to 500 VA for the motor mechanism.

The table below indicates the maximum permissible cable length for different supply voltages and cable cross-sectional areas.

Recommended maximum cable lengths (in metres)

Power supply voltage (V DC)		12 V		24 V		48 V	
Cable cross-section (mm ²)		1.5	2.5	1.5	2.5	1.5	2.5
MN	U source 100 %	15	–	160	–	640	–
	U source 85 %	7	–	40	–	160	–
MX	U source 100 %	60	–	240	–	960	–
	U source 85 %	30	–	120	–	480	–
Motor mechanism	U source 100 %	–	–	10	16	65	110
	U source 85 %	–	–	2	4	17	28

Note: The indicated length is that of each of the two wires.

External Neutral Voltage Tap (ENVT)

This connection is required for accurate power measurements on 3-pole circuit breakers equipped with MicroLogic 5/6 E trip units in installations with a distributed neutral. It can be used to measure phase-neutral voltages and calculate power using the 3 wattmeter method.

ComPacT NSX 3-pole circuit breakers come with a wire installed on the device for the connection to the ENVT.

This wire is equipped with a connector for connection to an external wire with the following characteristics:

- Cross-sectional area of 1 mm² to 2.5 mm²
- Maximum length of 10 metres.

External Neutral Current Transformer (ENCT)

This connection is required to protect the neutral on 3-pole circuit breakers equipped with MicroLogic 5/6 E trip units in installations with a distributed neutral. For MicroLogic 6 E, it is required for type G ground-fault protection.

The ENCT is connected in the same way for fixed, plug-in or withdrawable devices:

- Fixed devices are connected via terminals T1 and T2 of the internal terminal block.
- Plug-in and withdrawable devices are not connected via the auxiliary terminals. The wires must be connected/disconnected inside the device via terminals T1 and T2.

The ENCT must be connected to the MicroLogic trip unit by a shielded twisted pair. The shielding should be connected to the switchboard earth only at the CT end, no more than 30 cm from the CT.

- The power connections of the CT to the neutral (H2 and H1) must be made in the same way for power supply from the top or the bottom (see figure). Make sure they are not reversed for devices with power supply from the bottom.
- Cross-sectional area of 0.4 mm² to 1.5 mm²
- Maximum length of 10 metres.

ULP Connection System between MicroLogic, FDM121 Switchboard Display and Modbus Interface

The ULP (Universal Logic Plug) wiring system used by ComPacT NSX for connections through to the Modbus network requires neither tools nor settings. The prefabricated cords are used for both data transfer and distribution of 24 V DC power. Connectors on each component are identified by ULP (Universal Logic Plug) symbols, ensuring total compatibility between each component.

Available cords

All connections are made with prefabricated cords:

- NSX cord for connection of the internal terminal block to the Modbus interface or the FDM121 display via an RJ45 connector. The cord is available in three lengths, 0.35 m, 1.3 m and 3 m
- ULP cords with RJ45 connectors at each end for the other connections between components. The cord is available in six lengths, 0.3 m, 0.6 m, 1 m, 2 m, 3 m and 5 m. For greater distances, two cords can be interconnected using the RJ45 female/female accessory.

Maximum length of 10 m between 2 modules and 30 m in all.

A line terminator must be fitted to all components with an unused RJ45 connector.

External 24 V DC power-supply module (AD)

The external power-supply module makes it possible:

- To use the display even if the circuit breaker is open or not supplied (for the exact conditions of use, see the “electrical diagrams” part of this catalog)
- To display fault currents after tripping
- To modify settings when the circuit breaker is open (OFF position)

An external 24 V DC power supply is required for installation with communication, whatever the type of trip unit.

This module is not designed to power on 24 V DC voltage releases and electric motor mechanism.

This module powers both the control unit and the M2C programmable contacts. We recommended using the AD power supply due to its low stray primary secondary capacitance. Good operation of the MicroLogic control unit in noisy environment is not guaranteed with other power supplies.

If the COM option is used, a second dedicated power supply shall be used.

This module powers both the control unit and the M2C programmable contacts or ESM module.

Characteristics

- Power supply AC-to-DC or DC-to-DC
- Output voltage: 24 V DC $\pm 5\%$
- Output current: 1 A.
- DIN rail or platine Fixing with Acti9 form factor
- Conducted emissions power line: class B per EN/IEC 61000-6-3

Wiring (See Page E-87)

MicroLogic 5/6/7 not using the Communication function

The external 24 V DC supply is connected via the circuit breaker terminal block. Use of a 24 V DC battery provides backup power for approximate 3 hours (100 mA) in the event of an interruption in the external supply.

MicroLogic 5/6/7 using the Communication function

The external 24 V DC supply is connected via the Modbus interface using a five-pin connector, including two for the power supply. Stacking accessories (see page D-2) can be used to supply a number of interfaces by fast clip-on connection. The 24 V DC power is distributed downstream by the ULP (Universal Logic Plug) communication cords with RJ45 connectors. This system ensures both data transfer and power distribution to the connected modules.

Recommendations for 24 V DC wiring

- Do not connect the positive terminal to earth.
- Do not connect the negative terminal to earth.
- The maximum length for each conductor (+/-) is ten metres.
- For connection distances greater than ten metres, the plus and minus conductors of the 24 V DC supply must be twisted to improve EMC.
- The 24 V DC conductors must cross the power cables perpendicularly. If this is difficult or impossible, the plus and minus conductors must be twisted.

Modbus (See Page E-87)

Each ComPact NSX circuit breaker equipped with MicroLogic 5/6/7 and an FDM121 display is connected to the Modbus network via the Modbus interface module.

Connection of all the circuit breakers and other Modbus devices in the switchboard to a Modbus bus is made much easier by using a Modbus RJ45 junction block installed in the switchboard.

Recommendations for Modbus wiring

- The shielding may be earthed.
- The conductors must be twisted to improve immunity (EMC).
- The Modbus conductors must cross the power cables perpendicularly.

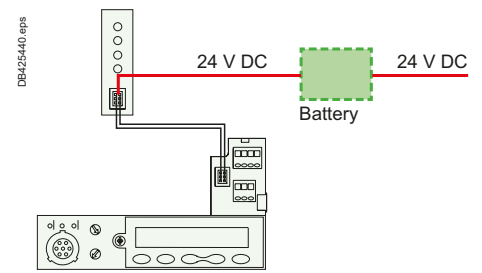

Power supply, without the Communication function, via the terminal block with a backup battery

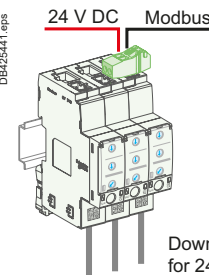

Downstream ULP wiring for 24 V DC supply



Supply, with the Communication function, via the Modbus interface



External 24 V DC power supply module (AD)





ABL8 RPS power supply

PF106348SE_ABL8RPS24050.eps

24 V DC Universal Phaseo™ ABL8 Power Supplies

The Universal Phaseo ABL8 RPS 24050 and ABL8 RPS 24030 power supplies can be connected phaseto-neutral or phase-to-phase.

They deliver a voltage that is precise to 3%, whatever the load and whatever the value of the AC

supply, within the ranges 85 to 132 V AC and 170 to 550 V AC.

The Universal Phaseo ABL8 powers:

- Circuit breaker communication module and interface
- Programmable MicroLogic.

Characteristics

- Power supply AC-to-DC
- Network frequency: 50/60 Hz (±5 %)
- Output voltage: 24 V DC ±3%.
- Output current: 3 or 5 A
- DIN rail or platine Fixing
- Conducted emissions power line: class B per EN/IEC 61000-6-3

To assist cooling there must be sufficient clearance around the Universal range Phaseo power supplies:

- 50 mm above and below
- 10 mm on the side.

		ABL8RPS●●●●	Module AD
Over Voltage Category		Cat I per VDE 0106-1	Cat IV per IEC 62477-1 (AC model) Cat III per IEC 62477-1 (DC model) Cat III per UL 61010-1
Degree of pollution as per IEC 60664-1		2	3
Input supply voltage AC		100...120 V AC and 200...500 V AC	110-130 or 200-240 V AC
Input supply voltage DC		N/A	24-30 or 48-60 or 100-125 V DC
Dielectric	Input/Output	4 kV rms -1 mn.	3 kV rms - 1 mn. (110-130 V AC and 200-240 V AC model) 3 kV rms - 1 mn. (110-125 V DC model) 2 kV rms - 1 mn. (24-30 V DC and 48-60 V DC model)
	Input/Ground	3.5 kV rms -1 mn.	3 kV rms - 1 mn.
	Output /Ground	0,5 kV rms - 1 mn.	1.5 kV rms - 1 mn.
Temperature		<ul style="list-style-type: none"> ■ 50 °C ■ 60 °C with 80 % of the rated current maximum 	70°C
Output current		3 A (ABL8RPS24030) 5 A (ABL8RPS24050)	1 A
Inrush current for 2 ms		< 30 A	< 20 A
Ripple		200 mV peak-peak	200 mV peak-peak
Output voltage limits		24 to 28.8 V DC	22.8 to 25.2 V DC
Protection degree		IP20	IP4x front face/IP2x terminals/IP3x other

Note: For the applications requiring an over voltage category higher than 2, a surge arrester shall be associated to ABL8 RPS power supplies. The iQuick20prd type 2 surge arrester is recommended.

ComPacT NSX Power Loss/ Resistance

Equipped with Thermal-Magnetic Trip Units

ComPacT NSX thermal power loss values are used to calculate total temperature rise in the switchboard in which the circuit breakers are installed.

The values indicated in the tables below are typical values for a device at full rated load and 50/60 Hz.

Power loss per pole (P/pole) in Watts (W)

The value indicated is the power loss at I_N , 50/60 Hz, for a three-pole or four-pole circuit breaker. Measurement and calculation of power loss are carried out in compliance with the recommendations of Annex G of standard IEC 60947-2.

Resistance per pole (R/pole) in milliohms (mΩ)

The value of the resistance per pole is provided as a general indication for a new device.

The value of the contact resistance must be determined on the basis of the measured voltage drop, in accordance with the manufacturer's test procedure (ABT instruction document no. 1 - BEE - 02.2 -A).

Note: This measurement is not sufficient to determine the quality of the contacts, i.e. the capacity of the circuit breaker to carry its rated current.

Additional power loss

Additional power loss is equal to the sum of the power dissipated by the following:

- VigiPacT add-on: note that the deviation of the N and L3 bars required to pass through the toroid results in higher power losses compared to those of the L1 and L2 bars (diagram opposite). When calculating total power loss, use L1, L2, L3 for a 3P device and N, L1, L2, L3 for a 4P device
- Disconnecting contacts (plug-in and withdrawable devices)
- Transformer module.

Calculation of total power loss

Total power loss at full rated load and 50/60 Hz is equal to the sum of the device and additional power losses per pole multiplied by the number of poles (2, 3 or 4).

If a Vigi is installed, it is necessary to differentiate between N and L3 on one hand and L1 and L2 on the other.

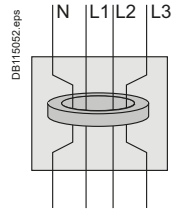

With a VigiPacT add-on, the deviation of the N and L3 bars required to pass through the toroid results in higher power losses compared to those of the L1 and L2 bars

ComPacT NSX100 to 250 Equipped with TM-D and TM-G Trip Units

Type of device	Fixed device			Additional power/pole					
	3/4 poles	Rat. (A)	R/pole	P/pole	VigiPacT add-on (N, L3)	VigiPacT add-on (L1, L2)	Plug-in/ withdr.	Transfo. module	PowerTag NSX module
NSX100	16		11.42	2.92	0	0	0	0	0
	25		6.42	4.01	0	0	0.1	0	0
	32		3.94	4.03	0.06	0.03	0.15	0.1	0
	40		3.42	5.47	0.10	0.05	0.2	0.1	0
	50		1.64	4.11	0.15	0.08	0.3	0.1	0.1
	63		2.17	8.61	0.3	0.15	0.4	0.1	0.1
	80		1.37	8.77	0.4	0.2	0.6	0.1	0.1
	100		0.88	8.8	0.7	0.35	1	0.2	0.2
NSX160	80		1.26	8.06	0.4	0.2	0.6	0.1	0.1
	100		0.77	7.7	0.7	0.35	1	0.2	0.2
	125		0.69	10.78	1.1	0.55	1.6	0.3	0.3
	160		0.55	13.95	1.8	0.9	2.6	0.5	0.5
NSX250	125		0.61	9.45	1.1	0.55	1.6	0.3	0.3
	160		0.46	11.78	1.8	0.9	2.6	0.5	0.5
	200		0.39	15.4	2.8	1.4	4	0.8	0.8
	250		0.3	18.75	4.4	2.2	6.3	1.3	1.3

ComPacT NSX100 to 630 Equipped with MA/1.3-M Trip Units

Type of device	Fixed device			Additional power/pole					
	3 poles	Rat. (A)	R/pole	P/pole	VigiPacT add-on (N, L3)	VigiPacT add-on (L1, L2)	Plug-in/ withdr.	Transfo. module	PowerTag NSX module
NSX100	2.5		148.42	0.93	0	0	0	0	0
	6.3		99.02	3.93	0	0	0	0	0
	12.5		4.05	0.63	0	0	0	0	0
	25		1.66	1.04	0	0	0.1	0	0
	50		0.67	1.66	0.2	0.1	0.3	0.1	0.1
	100		0.52	5.2	0.7	0.35	1	0.2	0.2
NSX160	150		0.38	8.55	1.35	0.68	2.6	0.45	0.5
NSX250	220		0.3	14.52	2.9	1.45	4.89	0.97	1
NSX400	320		0.12	12.29	3.2	1.6	6.14	1.54	1.43
NSX630	500		0.1	25	13.99	7	15	3.75	3.5



ComPacT NSX Power Loss/ Resistance

Equipped with Electronic Trip Units

The values indicated in the table below are typical values for a device at full rated load and 50/60 Hz. The definitions and information are the same as that for circuit breakers equipped with thermal-magnetic trip units.

ComPacT NSX100 to 630 Equipped with MicroLogic Trip Units

Type of device 3/4 poles	Rating (A)	Fixed device		Additional power (W)/ pole						
		R/pole (mΩ)	P/Pole (w)	VigiPacT add-on (N/ L3)	VigiPacT add-on (L1/L2)	Plug-In	Transfo Module	PowerTag NSX module		
NSX + MicroLogic 2.2/5.2/6.2										
NSX100	<40 A	0.84	1.3	0.1	0.06	0.2	0.1	0		
	40 A ≤ 100 A	0.47	4.7	0.7	0.35	1	0.2	0.2		
NSX160	<40 A	0.73	1.2	0.4	0.2	0.6	0.1	0		
	40 A ≤ 160 A	0.36	9.2	1.8	0.9	2.6	0.5	0.5		
NSX250	<40 A	0.27	2.7	1.1	0.55	1.6	0.2	0		
	40 A ≤ 250 A	0.28	17.6	4.4	2.2	6.3	1.3	1.3		
NSX + MicroLogic 2.3/5.3/6.3										
NSX400	<400 A	0.12		19.2		3.2	1.6	9.6	2.4	2.24
NSX630	<630 A	0.1		39.7		6.5	3.25	19.49	5.95	5.56
NSX + MicroLogic add-on 4.2/7.2		N/L1/L3	L2	N/L1/L3	L2					
NSX100	<100 A	0.58	0.49	5.8	4.9	-	-	1	0.2	0.2
NSX160	<160 A	0.48	0.39	12.3	10.0	-	-	2.6	0.5	0.5
NSX250	<250 A	0.4	0.33	25	20.6	-	-	6.3	1.3	1.3
NSX + MicroLogic add-on 4.3/7.3										
NSX400	<400 A	0.16	0.14	25.6	22.4	-	-	9.6	2.4	2.24
NSX630 ^[1]	<630 A	0.14	0.12	55.6	47.6	-	-	19.49	5.95	5.56

Power loss/resistance values presented above are not contractual.

[1] The power loss values for VigiPacT add-on and withdrawable circuit breakers are given for 570 A.

ComPacT NSXm Dimensions and Mounting

Circuit Breaker and Switch-Disconnecter

Circuit Breaker

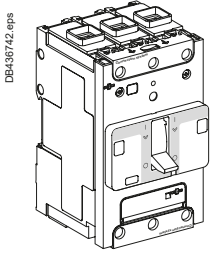

3P

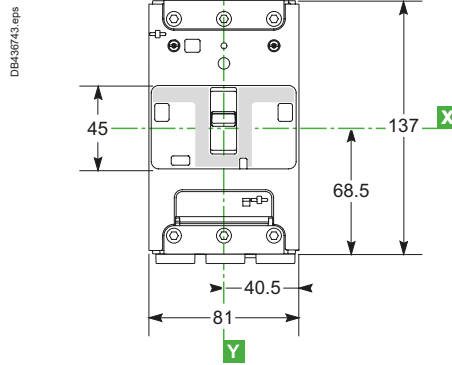

4P

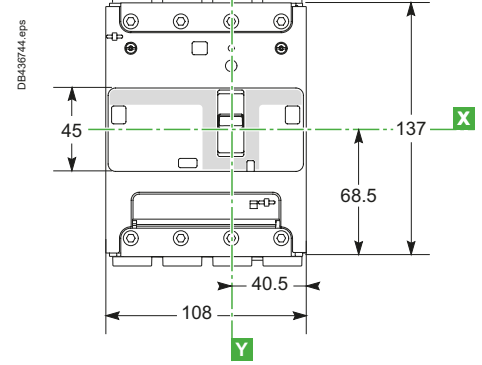

Circuit Breaker with MicroLogic Vigi 4.1

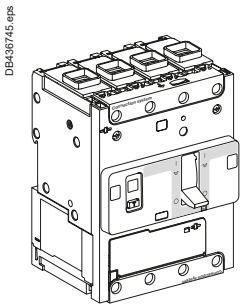

3P

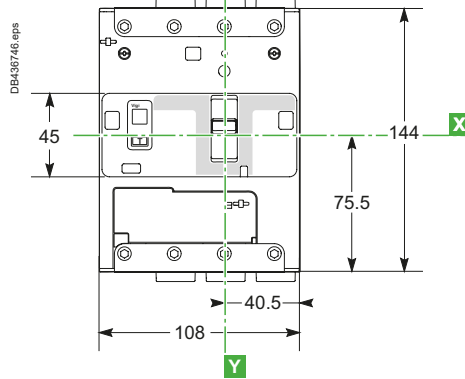

4P

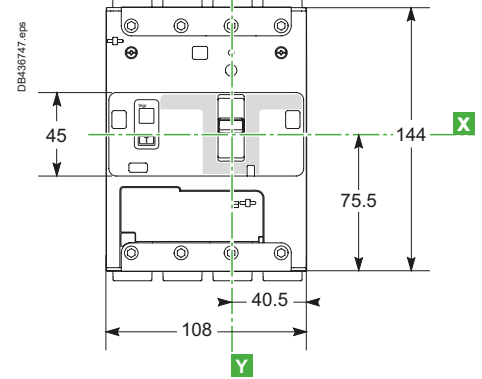

Side View

With SDx Module

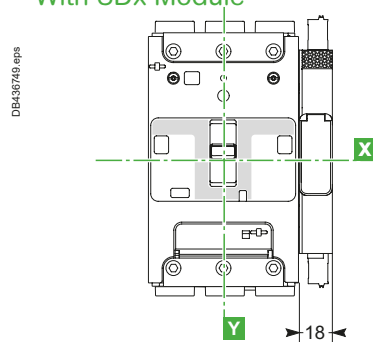
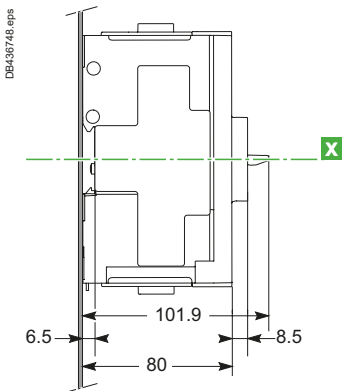

Front-Panel Cutouts

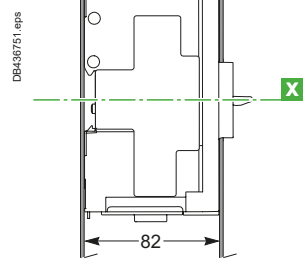
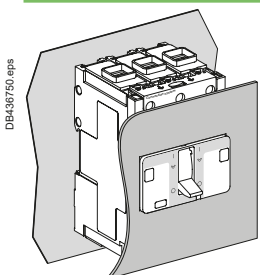

3P

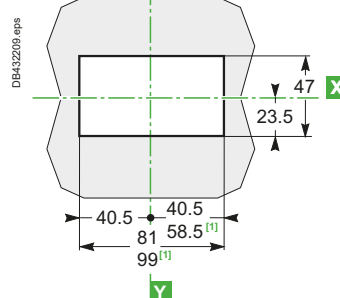

4P

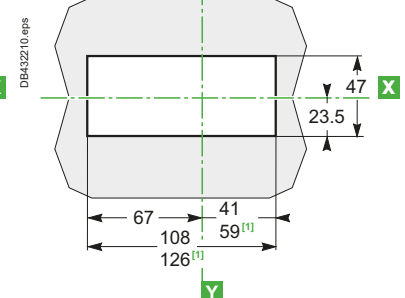

[1] With SDx module.



ComPacT NSXm Dimensions and Mounting

Circuit Breaker and Switch-Disconnecter

Connectors

EverLink with Control Wire Terminal Connector

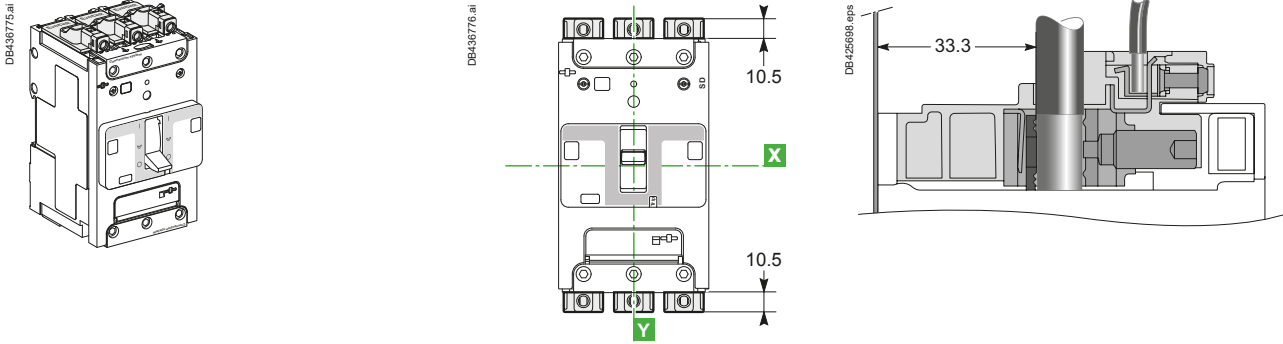

EverLink without Control Wire Terminal Connector

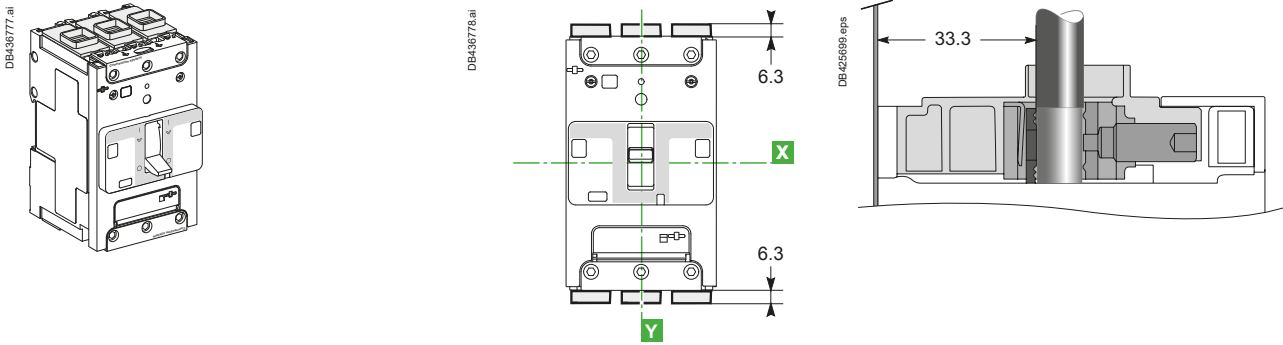

Mechanical Lug Connector

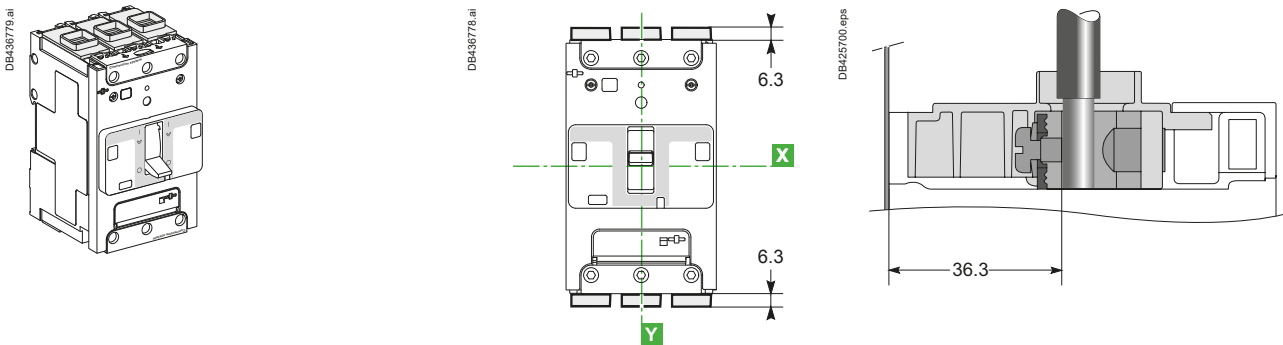

Compression Lug/Busbar Connector

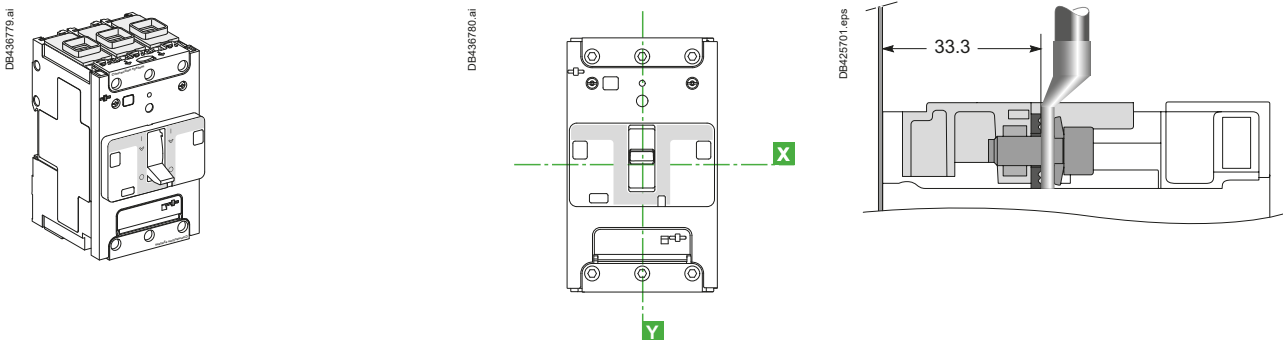

E

ComPacT NSXm Dimensions and Mounting

Circuit Breaker and Switch-Disconnecter

Insulation of Live Parts

Long Terminal Shields

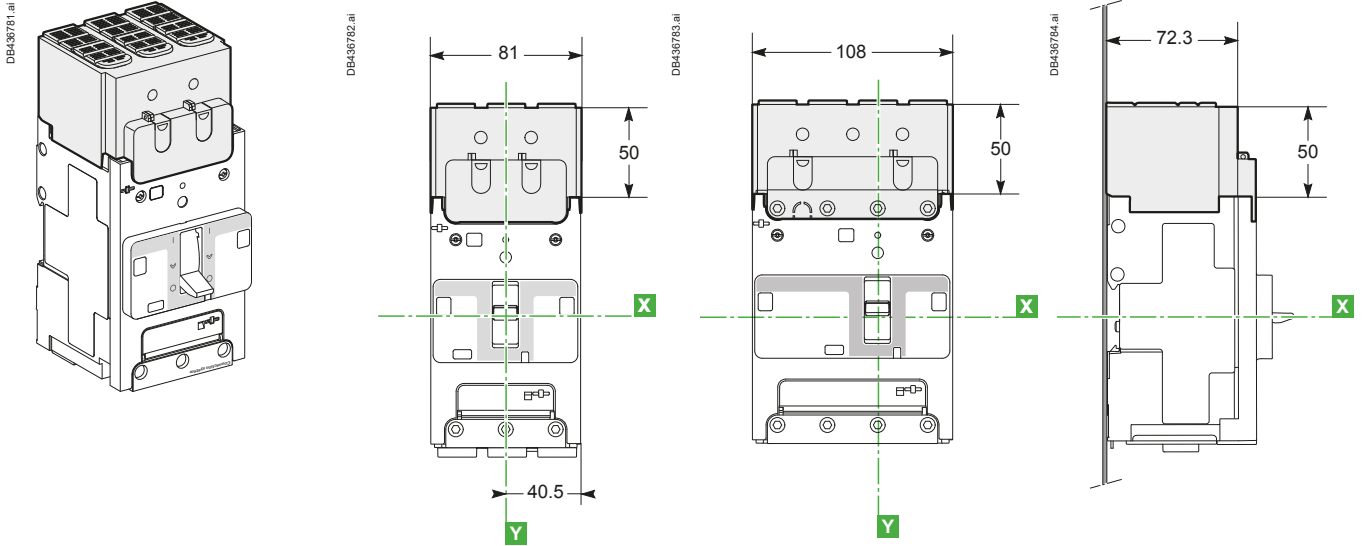

Interphase Barriers

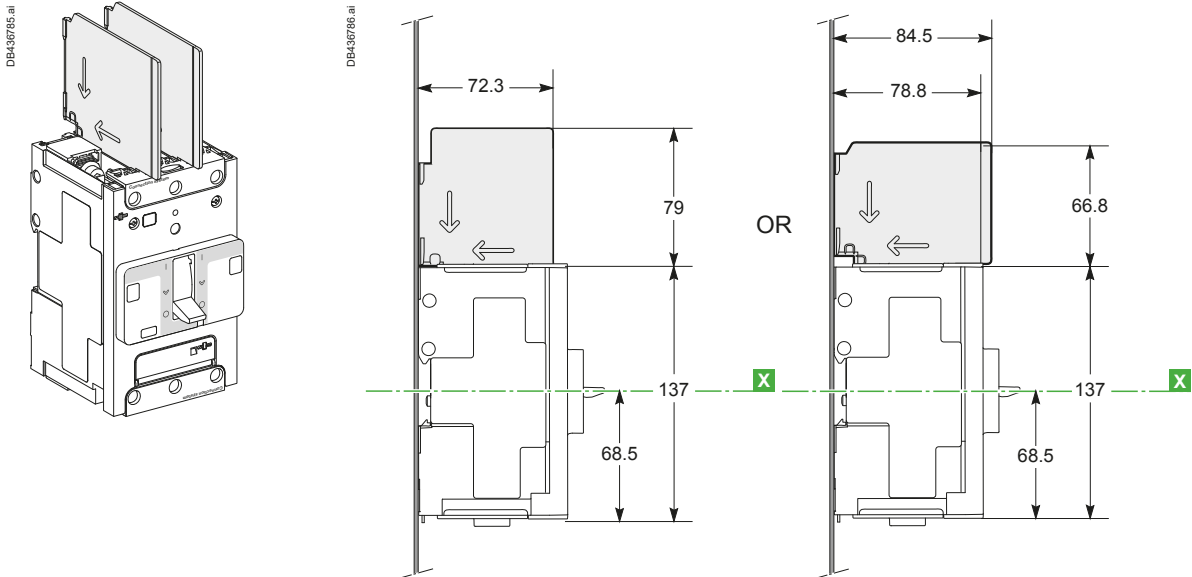

ComPacT NSXm Dimensions and Mounting

Circuit Breaker and Switch-Disconnecter

Rear Insulating Screens

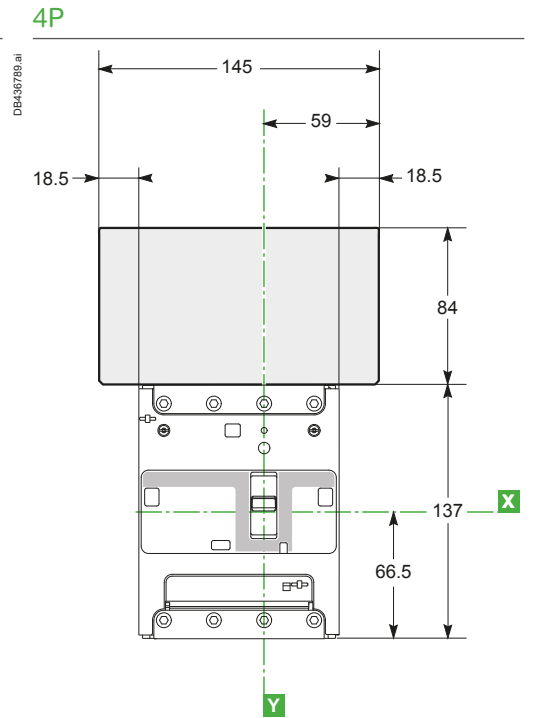
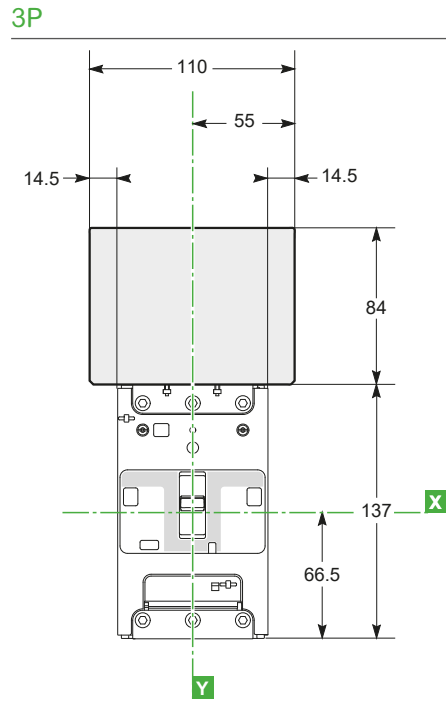
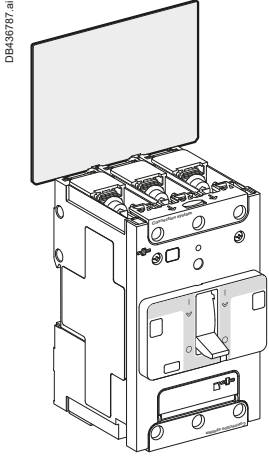

ComPacT NSXm Dimensions and Mounting Circuit Breaker and Switch-Disconnecter

Mounting on Backplate

3P/4P

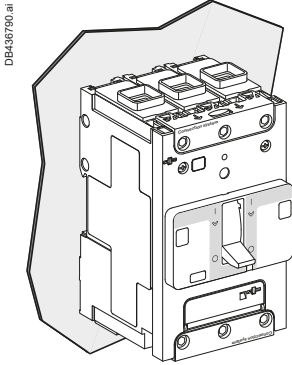

DB436790.ai

3P

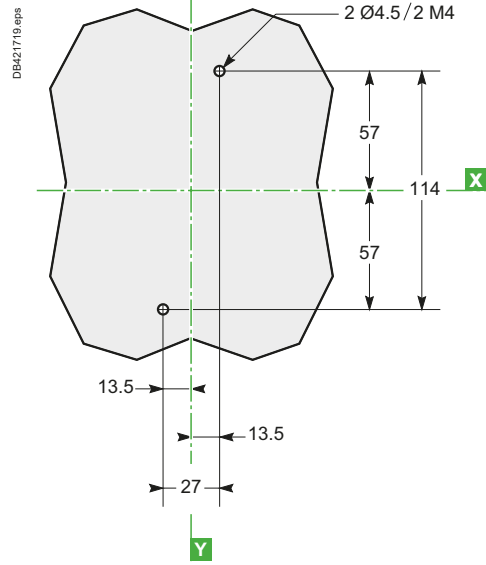

DB421719.eps

4P

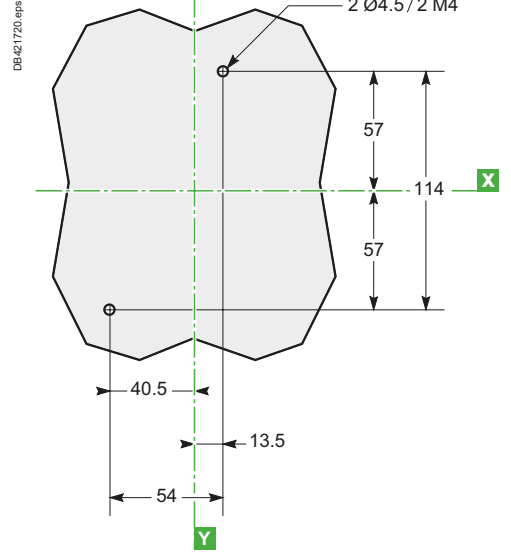

DB421720.eps

3P/4P Circuit Breaker with MicroLogic Vigi 4.1

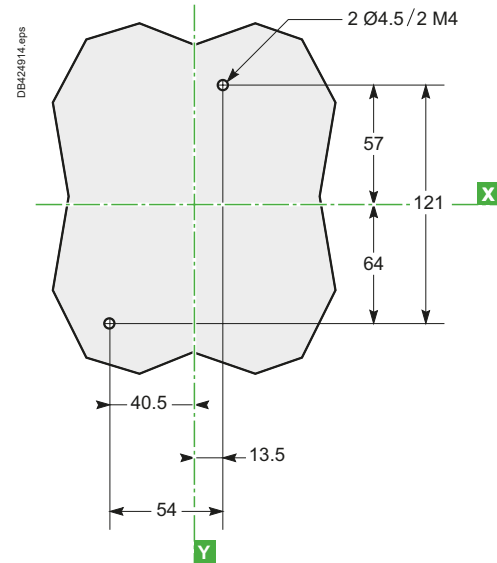

DB424814.eps



Mounting on DIN Rail

3P

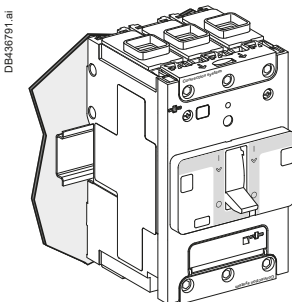

DB436791.ai

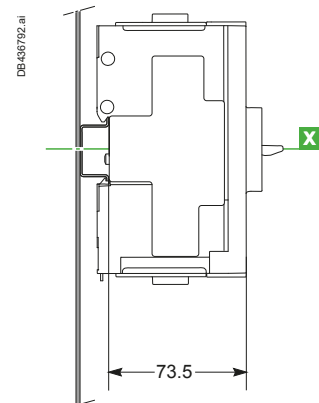

DB436792.ai

ComPacT NSXm Dimensions and Mounting

Circuit Breaker and Switch-Disconnecter

Direct Rotary Handle

3P

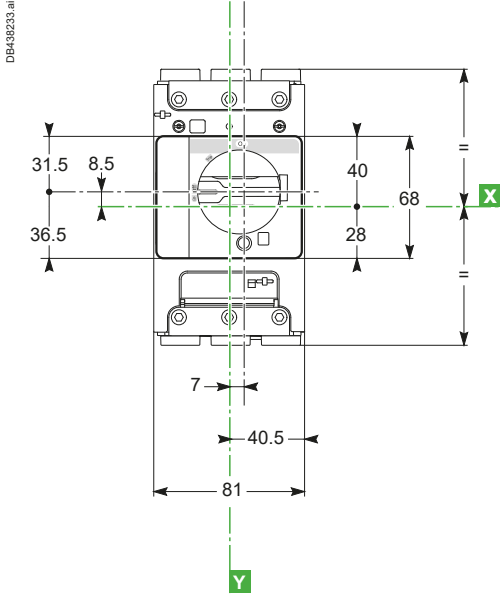

4P

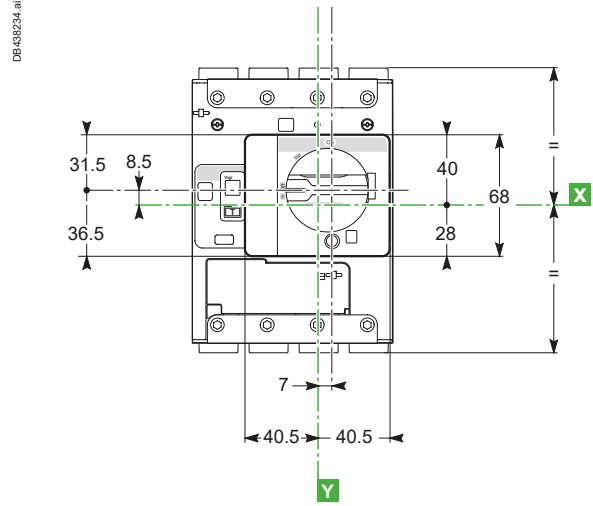

Side View

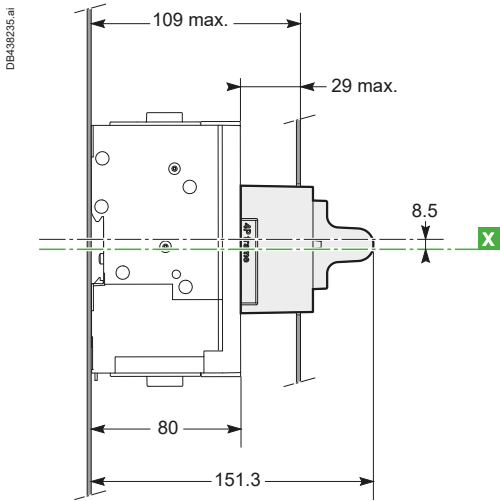

Door Cutout for 3P/4P

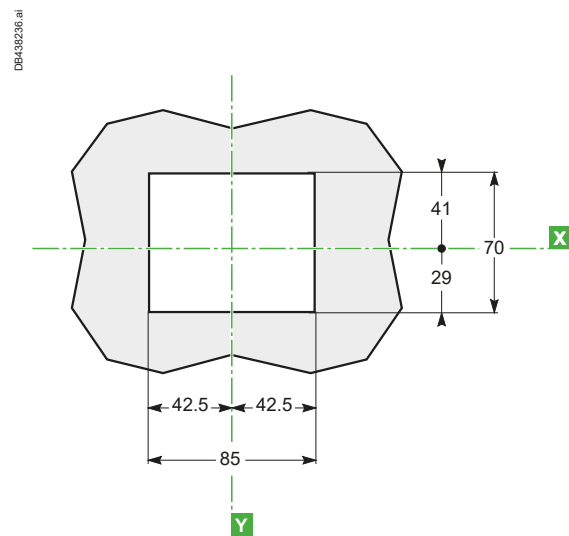

E

ComPacT NSXm Dimensions and Mounting Circuit Breaker and Switch-Disconnect

Extended Rotary Handle

3P

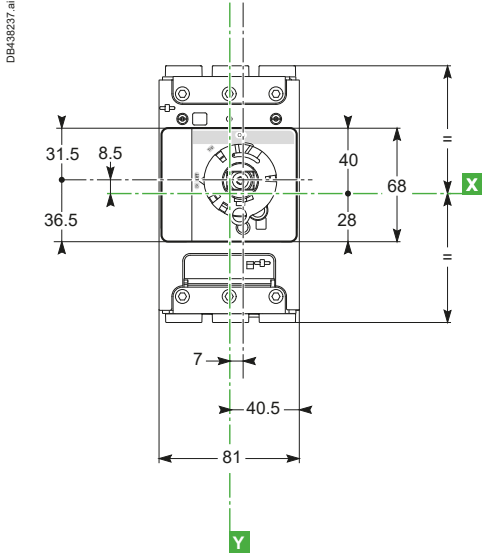

4P

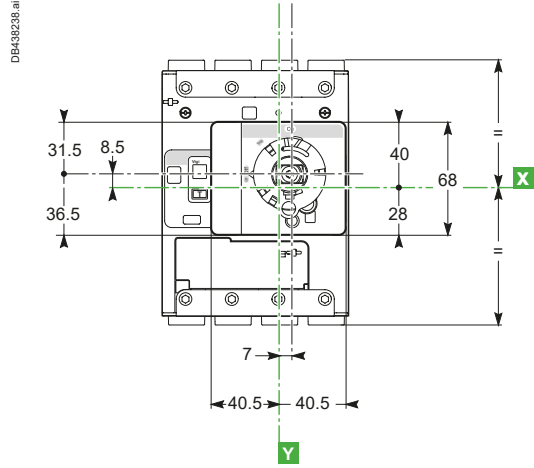

3P/4P

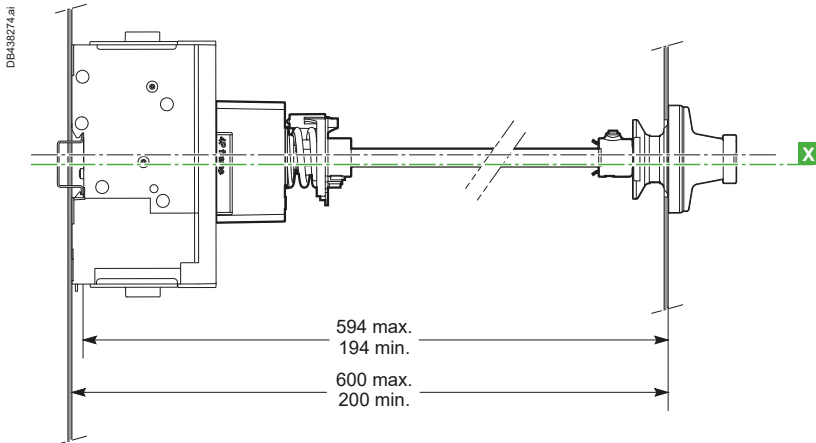

Dimensions and Front-Panel Cutout

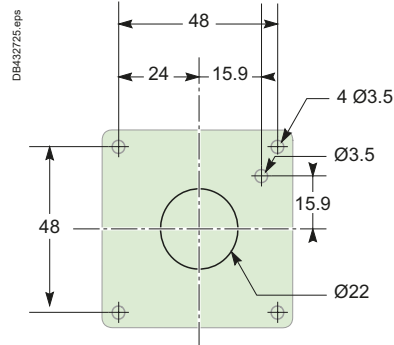
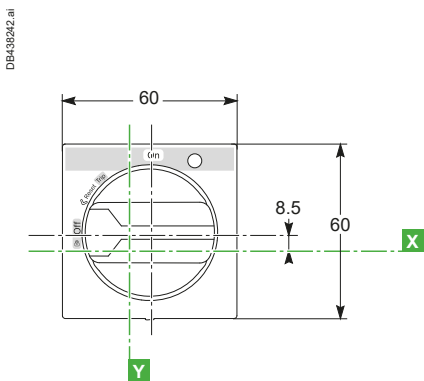

ComPacT NSXm Dimensions and Mounting

Circuit Breaker and Switch-Disconnecter

Side Rotary Handle

3P - Extended

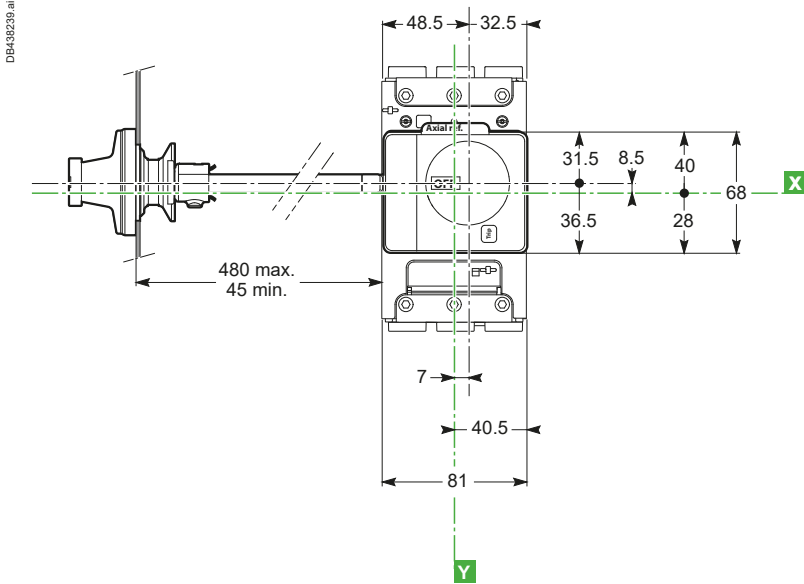

4P - Extended

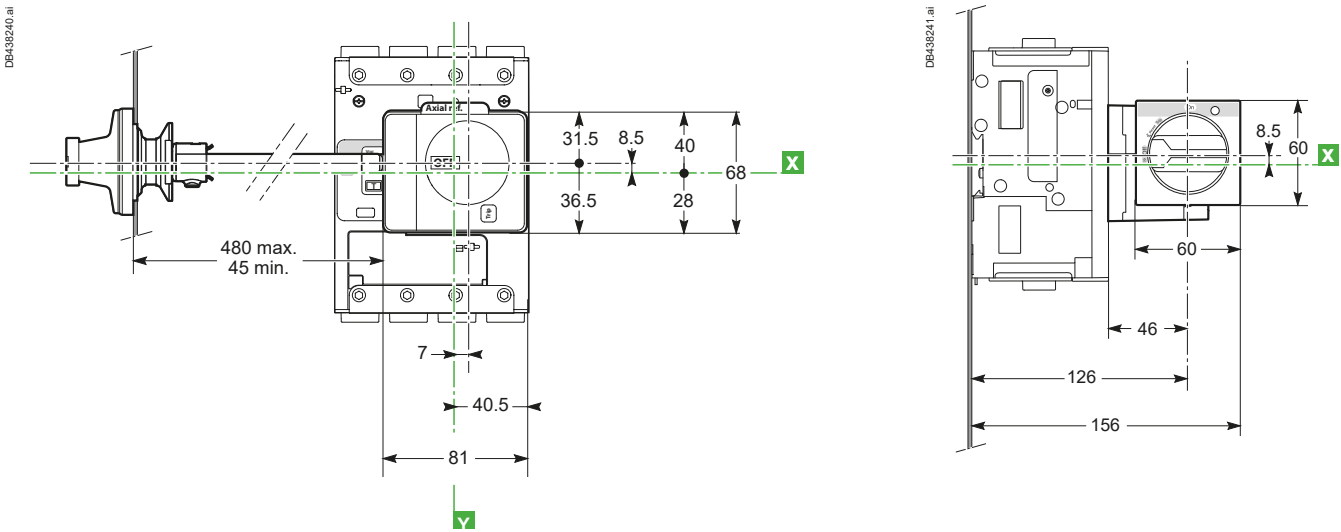

Dimensions Side Rotary Handle Cutout

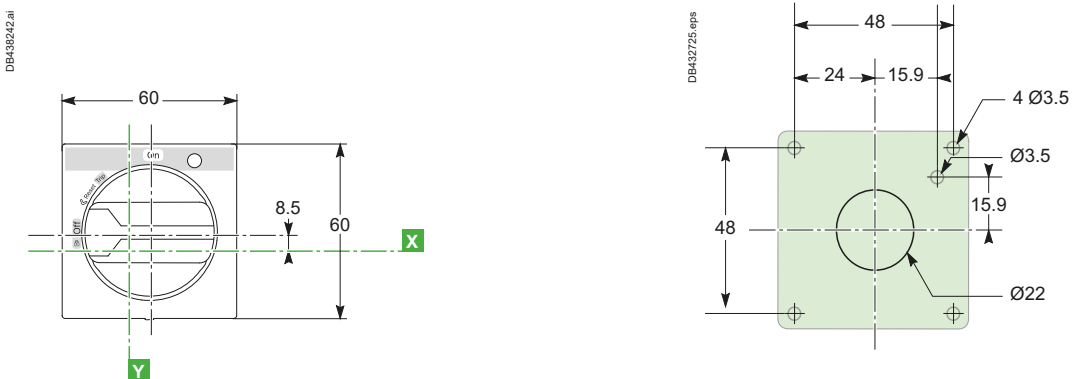

ComPacT NSXm Dimensions and Mounting

Circuit Breaker and Switch-Disconnecter

Connection with Accessories

Spreaders

3P

4P

Side View

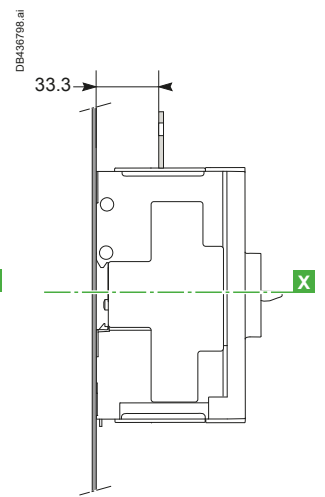
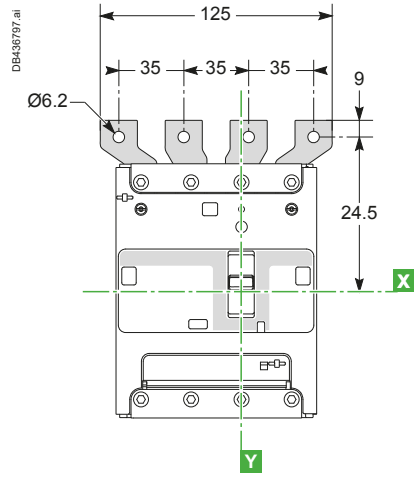
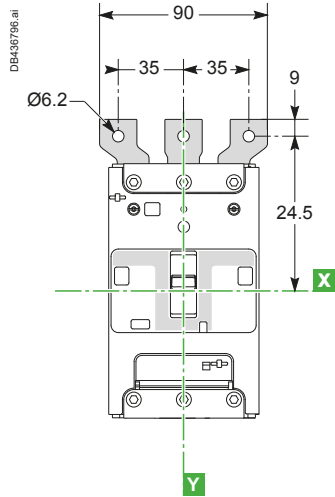
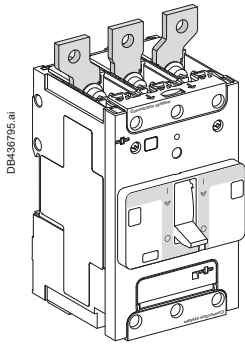

ComPacT NSX Dimensions and Mounting

ComPacT NSX100 to NSX250 Fixed Version, 1P-2P

Dimensions

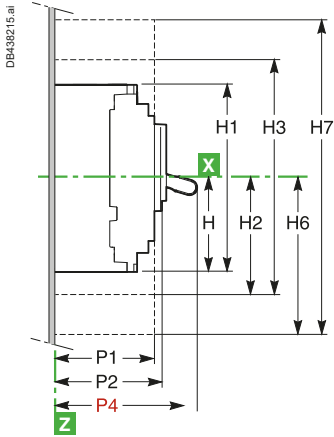

1 pole

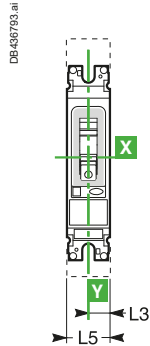

2 poles

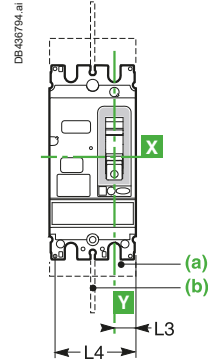

- (a) Short terminal shields.
- (b) Interphase barriers.

Mounting

On Backplate

1 pole

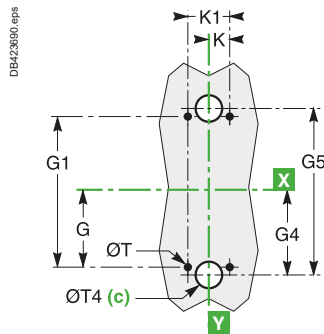

- (c) For rear connection only.

2 poles

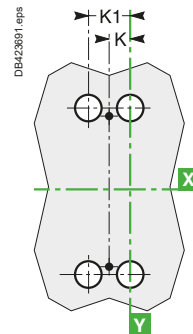

E

On Rails

1 pole

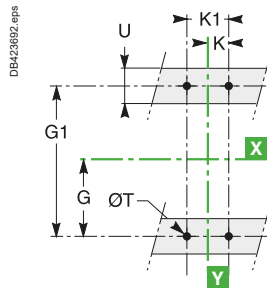

2 poles

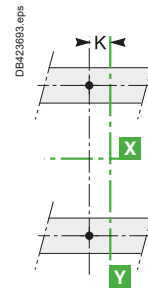

ComPacT NSX Dimensions and Mounting

ComPacT NSX100 to NSX250 Fixed Version, 1P-2P

Front-Panel Cutout

On Backplate

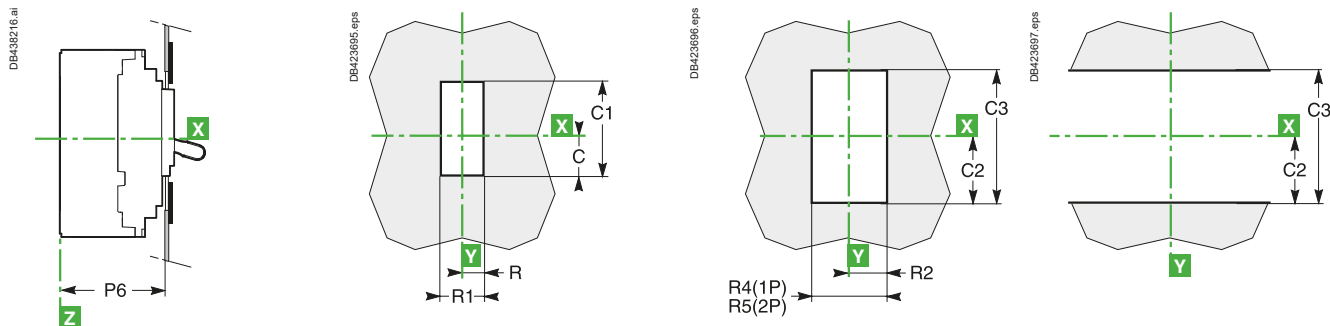

With Escutcheon

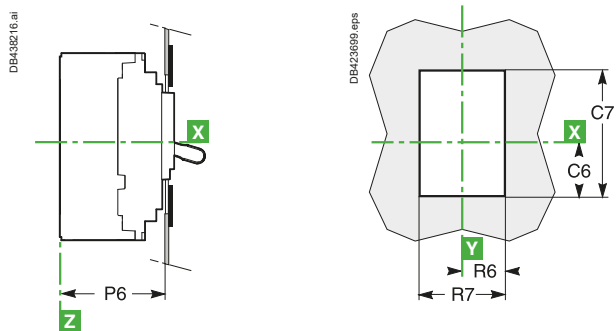

Dimensions (mm)

Type	C	C1	C2	C3	C6	C7	G	G1	G4	G5	H
NSX100/250	29	76	54	108	43	104	62.5	125	70	140	80.5
Type	H1	H2	H3	H4	H6	H7	K	K1	L3	L4	L5
NSX100/250	161	94	188	160.5	178.5	357	17.5	35	17.5	70	35
Type	P1	P2	P4	P5	P6	R	R1	R2	R4	R5	R6
NSX100/250	81	86	111	83	88	14.5	29	19	38	73	29
Type	R7	ØT	ØT4	U							
NSX100/250	58	6	22	≤ 32							



ComPacT NSX Dimensions and Mounting

ComPacT NSX100 to 630 Fixed Version

Dimensions

3P

4P

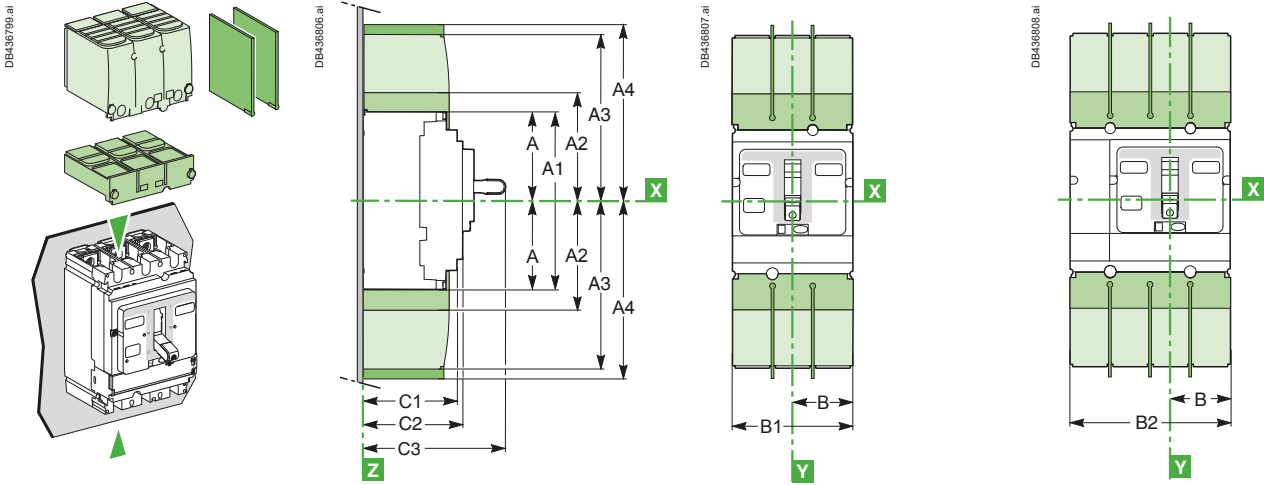

Interphase barriers.
 Long terminal shields (also available for NSX400/630 spreaders with 52.5 mm pitch):
 Short terminal shields.
 B1 = 157.5 mm, B2 = 210 mm.

Mounting

NSX100 to 250

NSX400/630 [2]

NSX100 to 630 [2]

On Backplate

3P

3P

4P

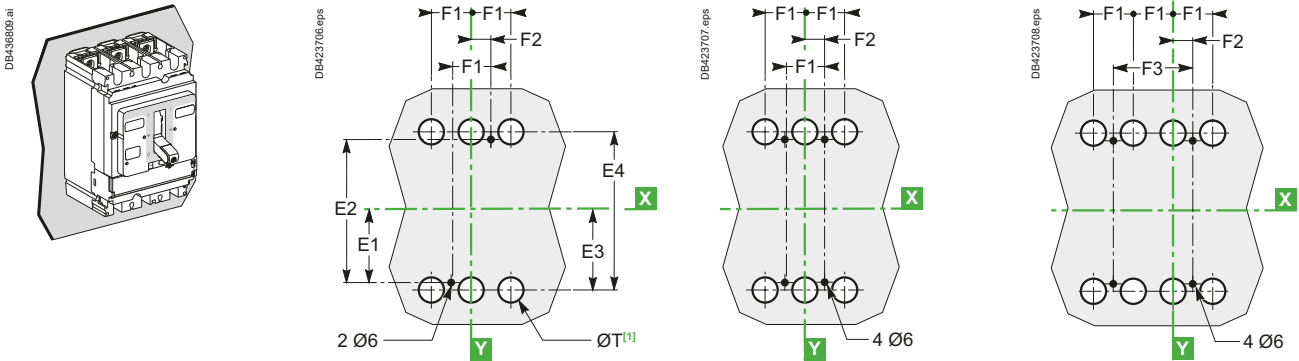

[2] For 630 A only:

[1] The ØT holes are required for rear connection only.
For two-pole circuit breakers, the middle holes are not required.

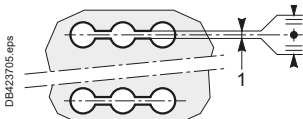

On Rails

3P

3P

4P

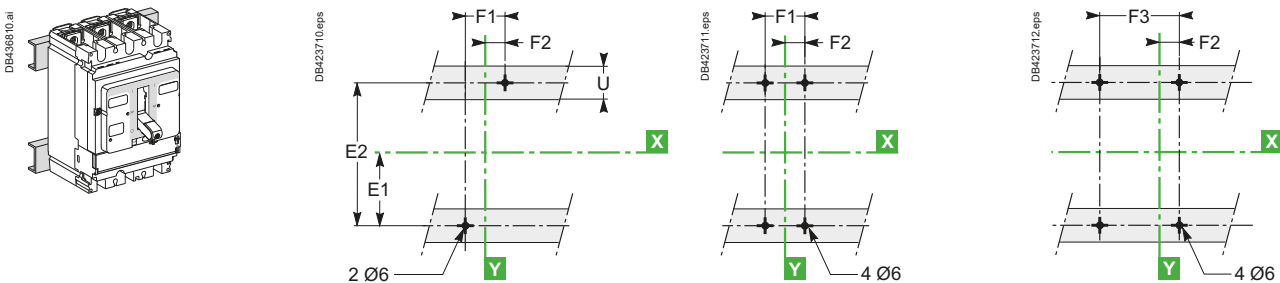

On DIN Rail with Adapter Plate (NSX100 to 250)

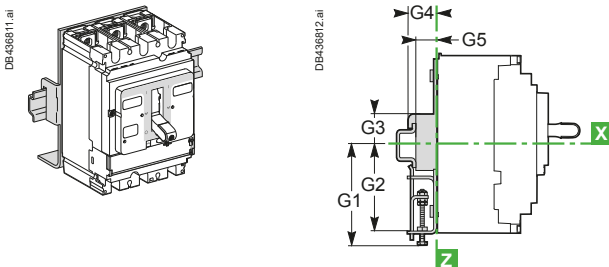

ComPacT NSX Dimensions and Mounting

ComPacT NSX100 to 630 VigiPacT Add-on Fixed Version

Dimensions

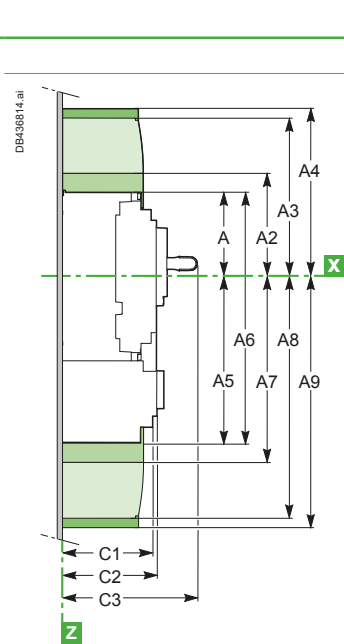
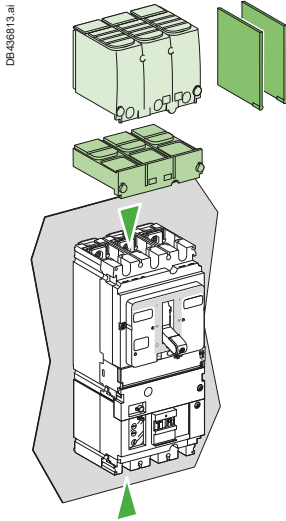

3/4P
NSX100 to 250

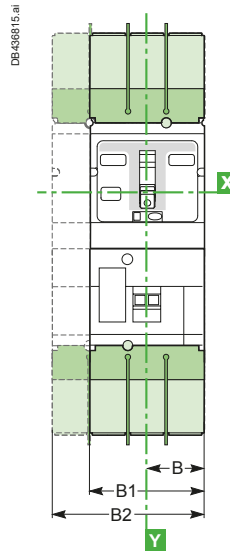

3/4P
NSX400/630

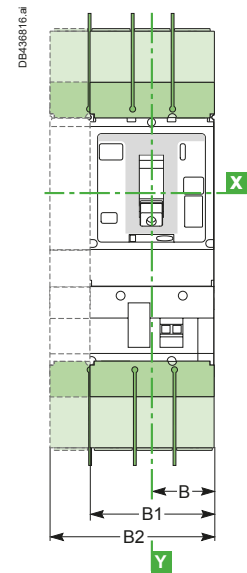

Mounting

On Backplate

NSX100 to 250

3P

NSX400/630 [2]

3P

NSX100 to 630 [2]

4P

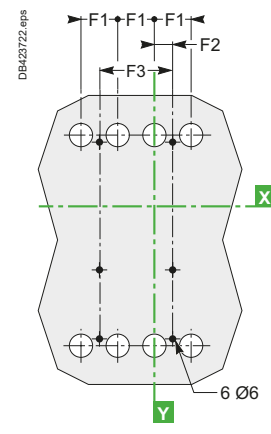
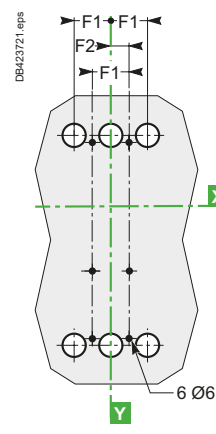
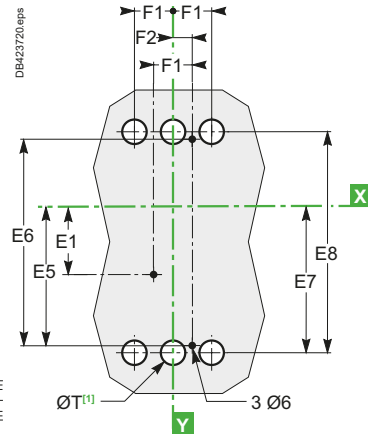
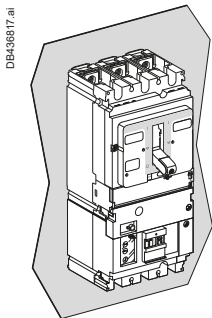

[2] For 630 A only:

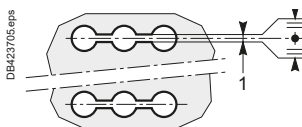

[1] The ØT holes are required for rear connection only.
For two-pole circuit breakers, the middle holes are not required.

On Rails

3P

3P

4P

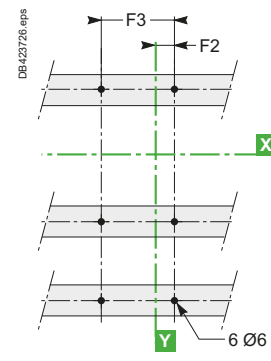
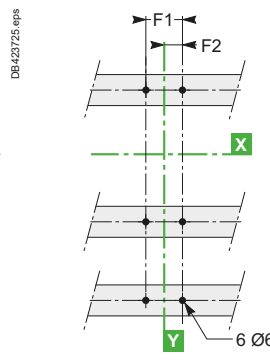
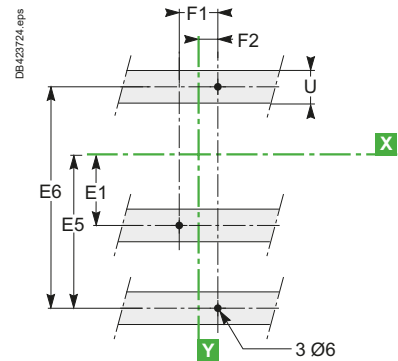
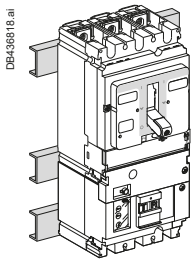

Type	A	A1	A2	A3	A4	A5	A6	A7	A8	A9	B	B1	B2	C1	C2	C3	E1
NSX100/160/250	80.5	161	94	145	178.5	155.5	236	169	220	253.5	52.5	105	140	81	86	126	62.5
NSX400/630	127.5	255	142.5	200	237	227.5	355	242.5	300	337	70	140	185	105	110	168	100
Type	E2	E3	E4	E5	E6	E7	E8	F1	F2	F3	G1	G2	G3	G4	G5	ØT	U
NSX100/160/250	125	70	140	137.5	200	145	215	35	17.5	70	95	75	13.5	23	17.5	24	≤ 32
NSX400/630	200	113.5	227	200	300	213.5	327	45	22.5	90	-	-	-	-	-	32	≤ 35

ComPacT NSX Dimensions and Mounting

ComPacT NSX100 to 630 Plug-in Version

Dimensions

3P

4P

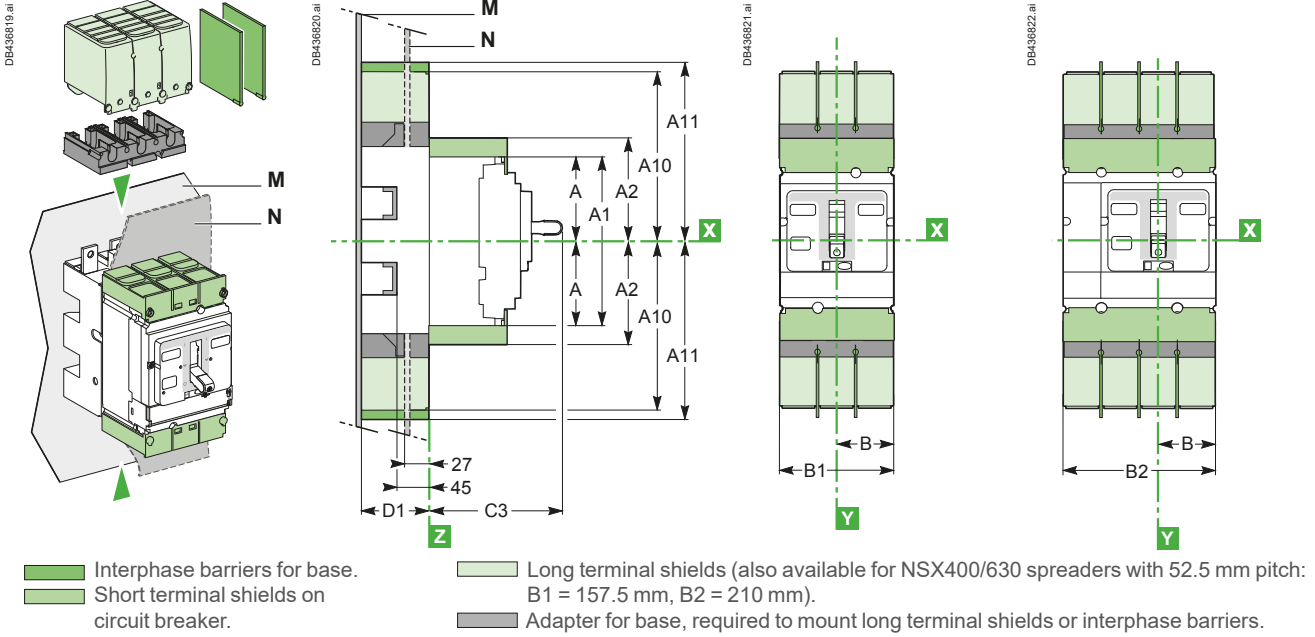

Mounting

Through Front Panel (N)

3P

3P

4P

NSX400/630

NSX100 to 630

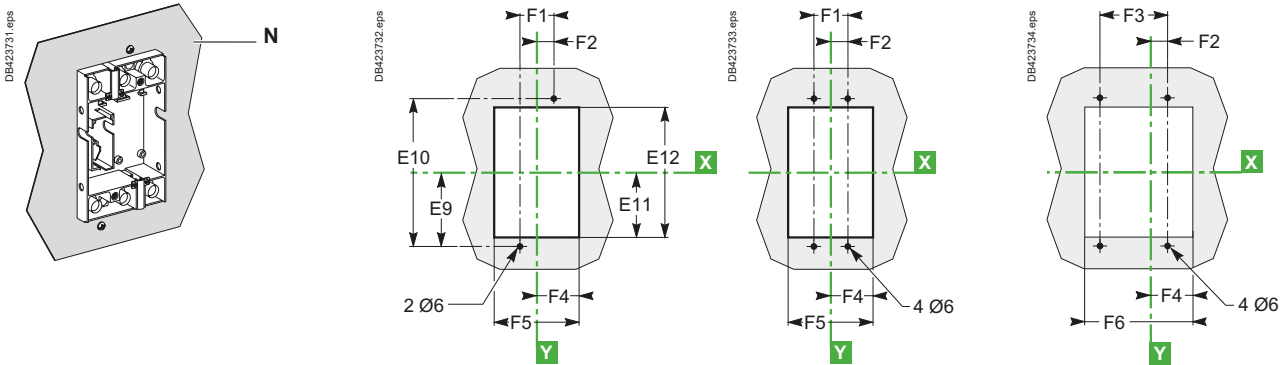

ComPacT NSX Dimensions and Mounting

ComPacT NSX100 to 630 Plug-in Version

On Backplate (M)

Front connection (an insulating screen is supplied with the base and must be fitted between the base and the backplate)

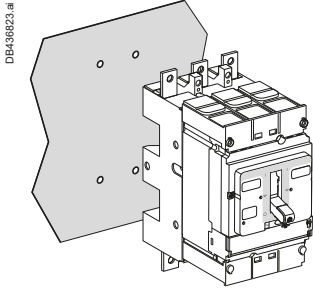

3P

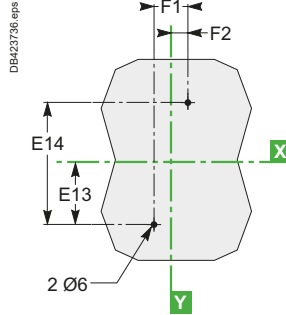

4P

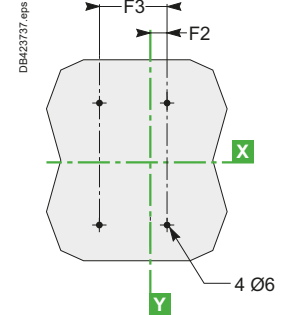

Connection by exterior-mounted rear connectors

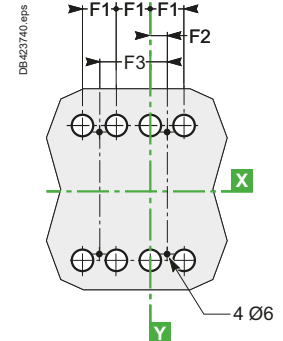
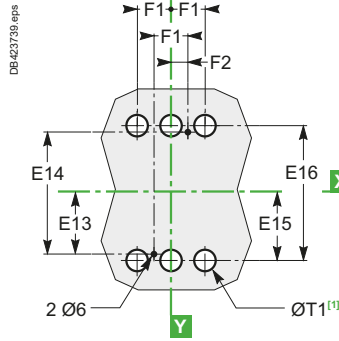
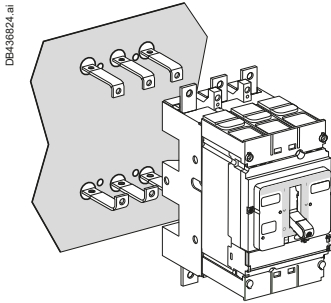

[1] The ØT1 holes are required for rear connection only (for two-pole circuit breakers, the middle holes are not required).

Connection by interior-mounted rear connectors

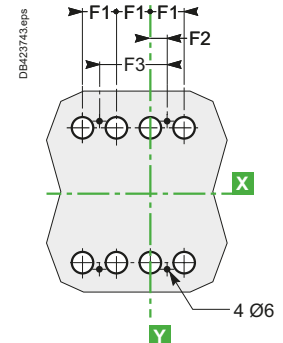
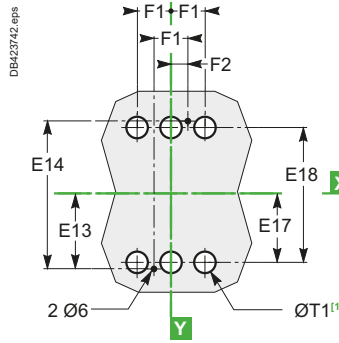
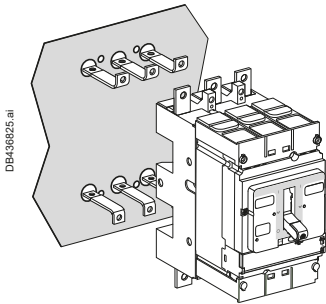

[1] The ØT1 holes are required for rear connection only (for two-pole circuit breakers, the middle holes are not required).

On Rails

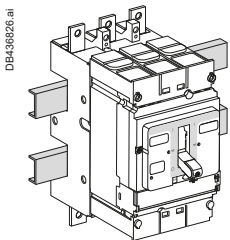

3P

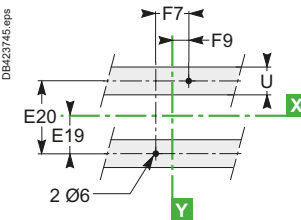

4P

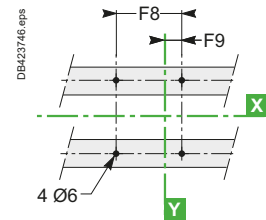

Type	A	A1	A2	A10	A11	B	B1	B2	C3	D1	E9	E10	E11	E12	E13	E14	E15
NSX100/160/250	80.5	161	94	175	210	52.5	105	140	126	75	95	190	87	174	77.5	155	79
NSX400/630	127.5	255	142.5	244	281	70	140	185	168	100	150	300	137	274	125	250	126
Type	E16	E17	E18	E19	E20	F1	F2	F3	F4	F5	F6	F7	F8	F9	ØT1	U	
NSX100/160/250	158	61	122	37.5	75	35	17.5	70	54.5	109	144	70	105	35	24	≤32	
NSX400/630	252	101	202	75	150	45	22.5	90	71.5	143	188	100	145	50	33	≤35	

ComPacT NSX Dimensions and Mounting

ComPacT NSX100 to 630 Withdrawable Version

Dimensions

3P

4P

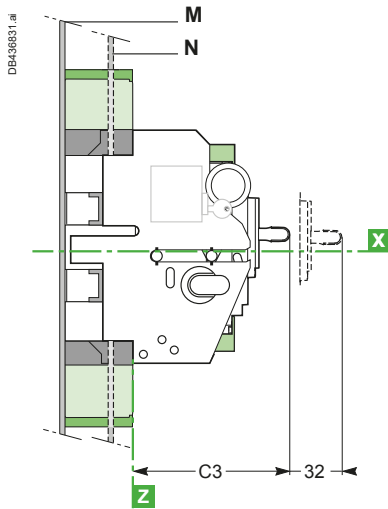
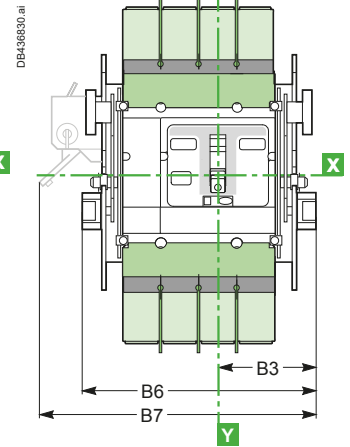
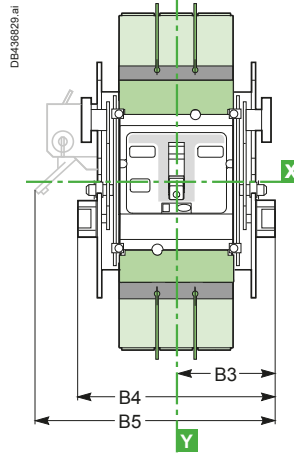
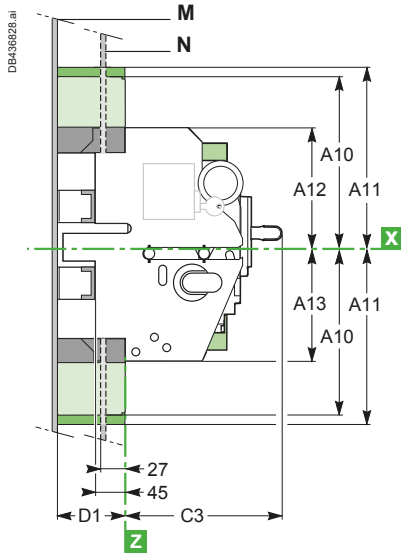
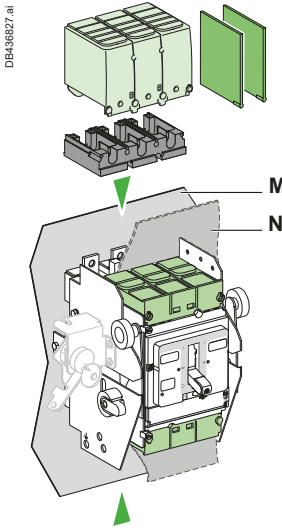

- Interphase barriers for base.
- Short terminal shields on circuit breaker.
- Long terminal shields.
- Adapter for base, required to mount long terminal shields or interphase barriers.

Mounting

Through Front Panel (N)

2/3P

3P

4P

NSX100 to 250

NSX400/630

NSX100 to 630

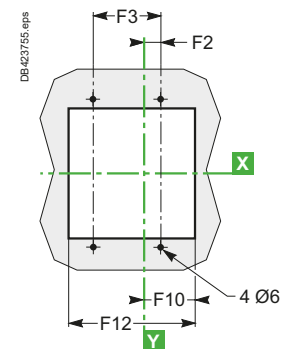
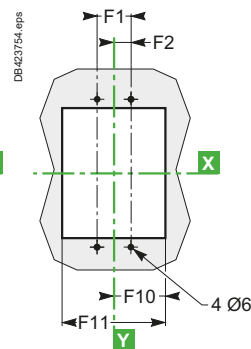
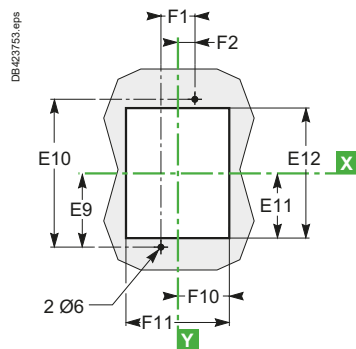
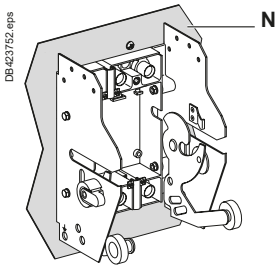

ComPacT NSX Dimensions and Mounting

ComPacT NSX100 to 630 Withdrawable Version

On Backplate (M)

Front connection (an insulating screen is supplied with the base and must be fitted between the base and the backplate)

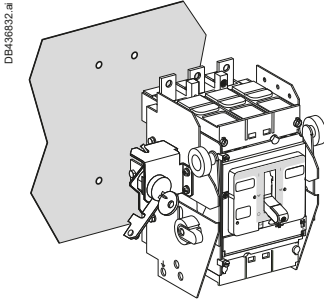

3P

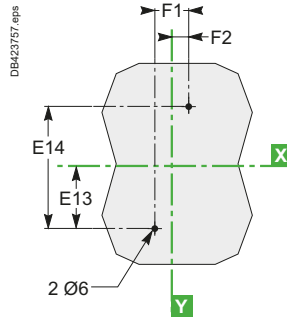

4P

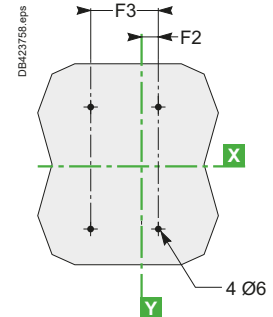

Connection by exterior-mounted rear connectors

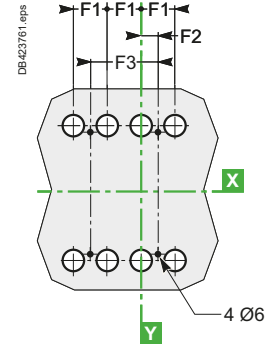
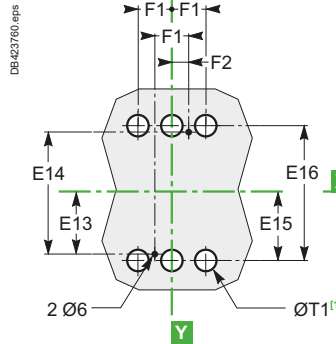
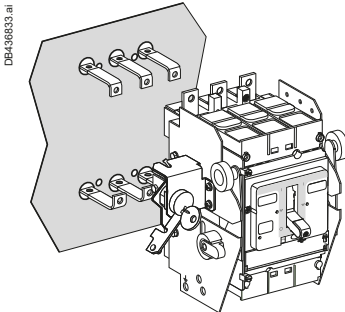

[1] The ØT1 holes are required for rear connection only (for two-pole circuit breakers, the middle holes are not required).

Connection by interior-mounted rear connectors

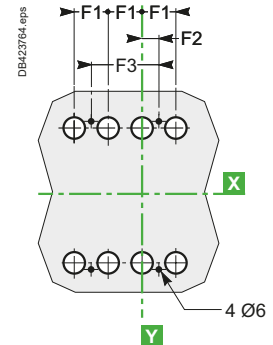
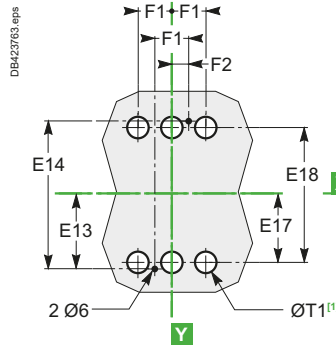
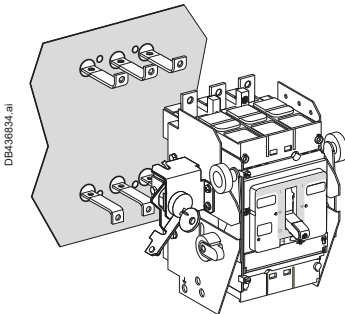

[1] The ØT1 holes are required for rear connection only (for two-pole circuit breakers, the middle holes are not required).

On Rails

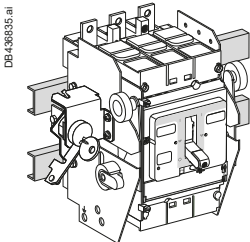

3P

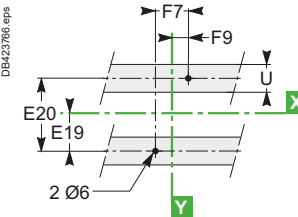

4P

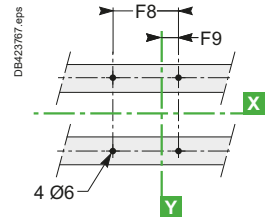

Type	A10	A11	A12	A13	B3	B4	B5	B6	B7	C3	D1	E9	E10	E11	E12	E13	E14
NSX100/160/250	175	210	106.5	103.5	92.5	185	216	220	251	126	75	95	190	87	174	77.5	155
NSX400/630	244	281	140	140	110	220	250	265	295	168	100	150	300	137	274	125	250
Type	E15	E16	E17	E18	E19	E20	F1	F2	F3	F7	F8	F9	F10	F11	F12	ØT1	U
NSX100/160/250	79	158	61	122	37.5	75	35	17.5	70	70	105	35	74	148	183	24	≤ 32
NSX400/630	126	252	101	202	75	150	45	22.5	90	100	145	50	91.5	183	228	33	≤ 35

ComPacT NSX Dimensions and Mounting

ComPacT NSX100 to 630 VigiPacT Add-on Plug-in and Withdrawable Versions

Dimensions - Plug-in Version

NSX100 to 250 3/4P

NSX400/630 3/4P

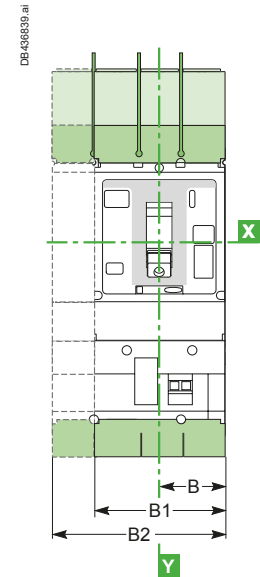
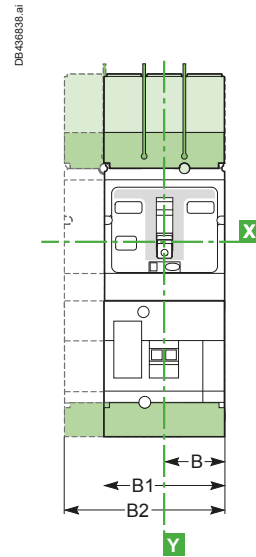
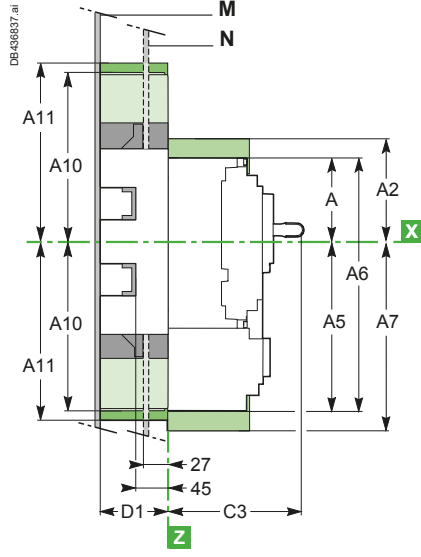
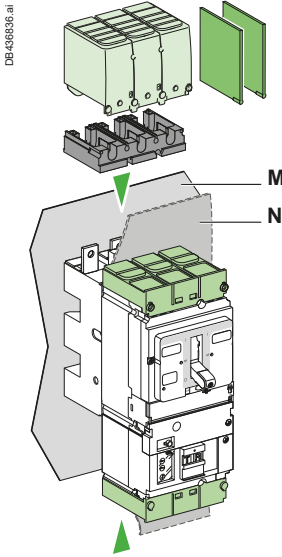

Interphase barriers for base.
Short terminal shields on circuit breaker.

Long terminal shields (also available for NSX400/630 spreaders with 52.5 mm pitch: B1 = 157.5 mm, B2 = 210 mm).
Adapter for base, required to mount long terminal shields or interphase barriers.

Dimensions - Withdrawable Version

NSX100 to 630 3P

4P

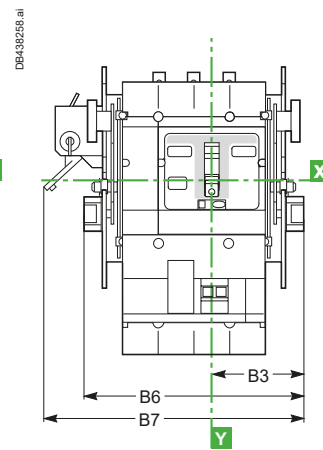
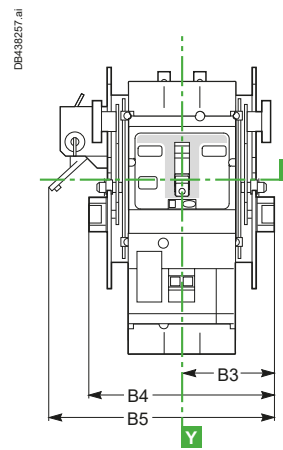
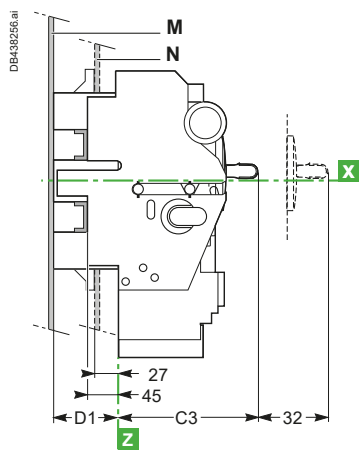
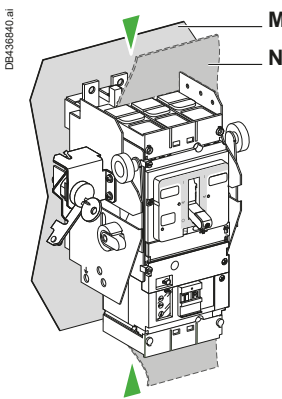

Mounting

Through front panel (N)

See ComPacT NSX100 to 630 plug-in version, [page E-38](#), or withdrawable version, [page E-40](#)

On backplate (M)

See ComPacT NSX100 to 630 plug-in version, [page E-39](#), or withdrawable version, [page E-41](#)

On rails

See ComPacT NSX100 to 630 plug-in version, [page E-39](#), or withdrawable version, [page E-41](#)

Type	A	A2	A5	A6	A7	A10	A11	B	B1	B2	B3	B4	B5	B6	B7	C3	D1
NSX100/160/250	80.5	94	155.5	236	169	175	210	52.5	105	140	92.5	185	216	220	251	126	75
NSX400/630	127.5	142.5	227.5	355	242.5	244	281	70	140	185	110	220	250	265	295	168	100

ComPacT NSX Dimensions and Mounting

Visu Function for ComPacT NSX100 to 250 Fixed Version

Dimensions - Combination with ComPacT INV100 to 250

3P

4P

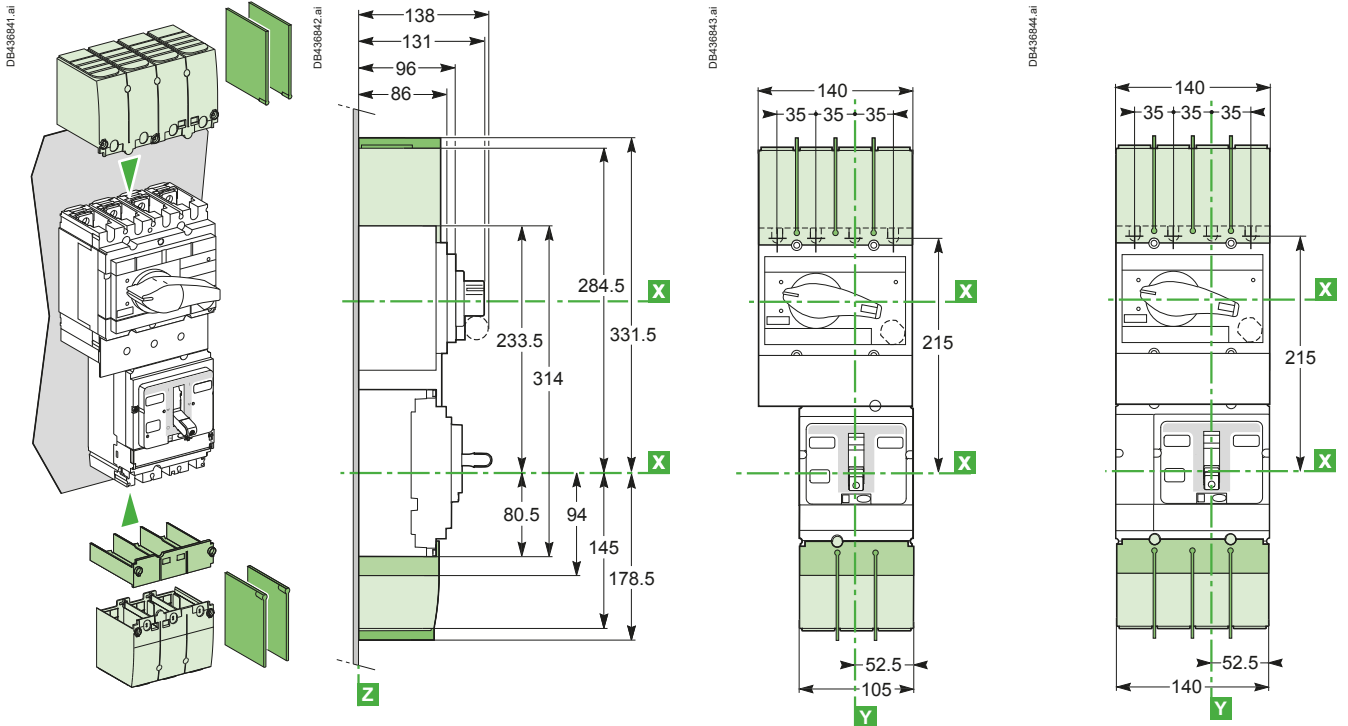

Mounting On Rails or Backplate

3P

4P

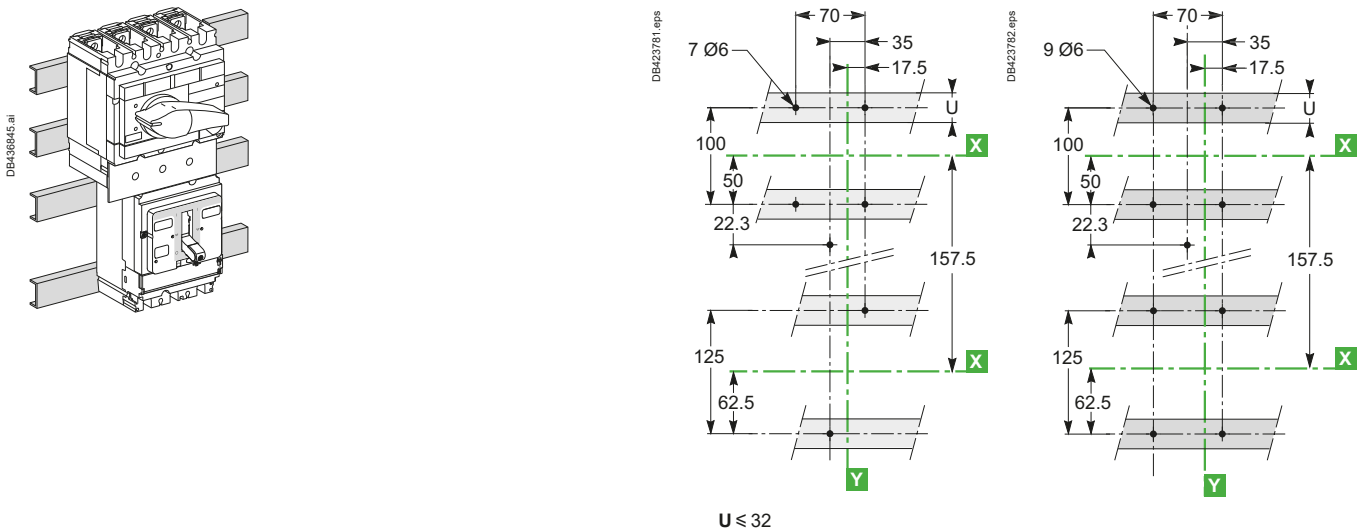

ComPacT NSX Dimensions and Mounting

Visu Function for ComPacT NSX400/630 Fixed Version

Dimensions - Combination with ComPacT INV400 to 630

3P

4P

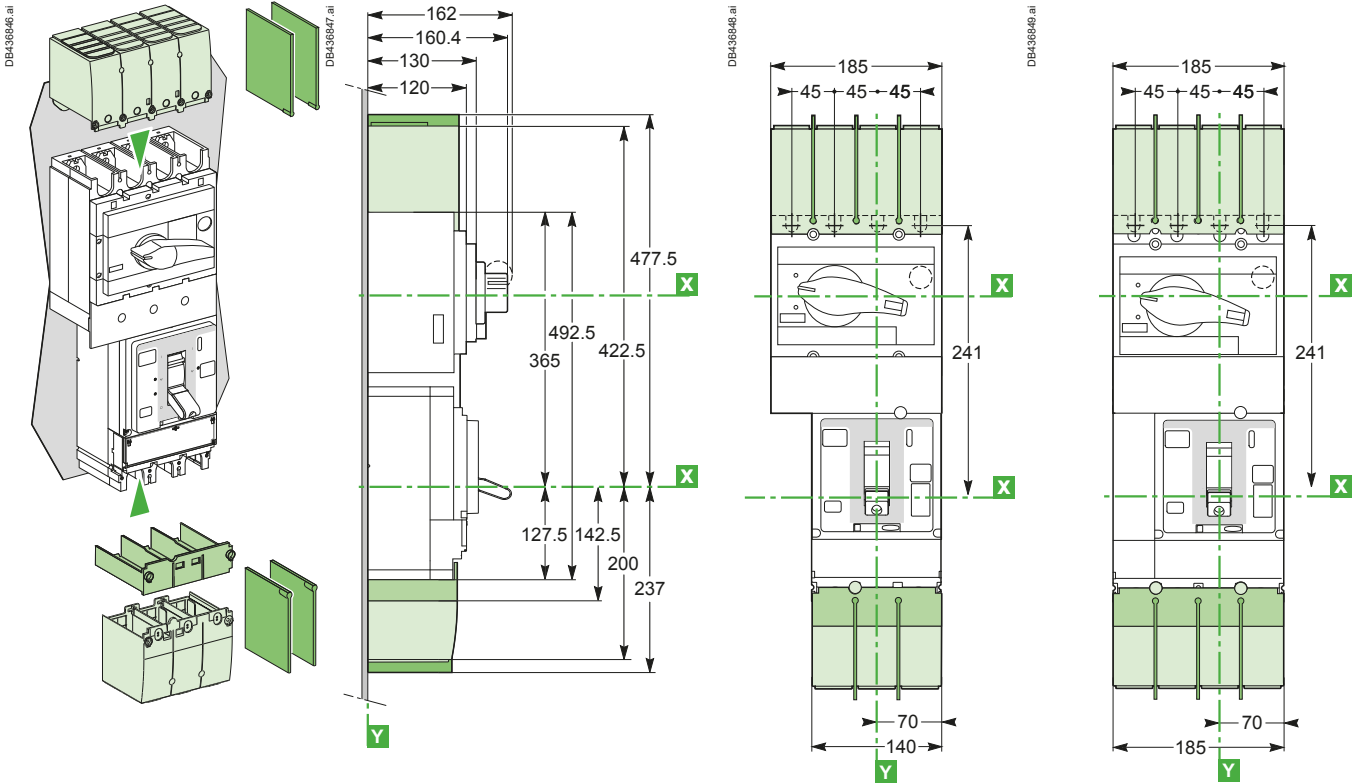

E

- Interphase barriers for base.
- Short terminal shields.
- Long terminal shields.

Mounting

On Rails or Backplate

3P

4P

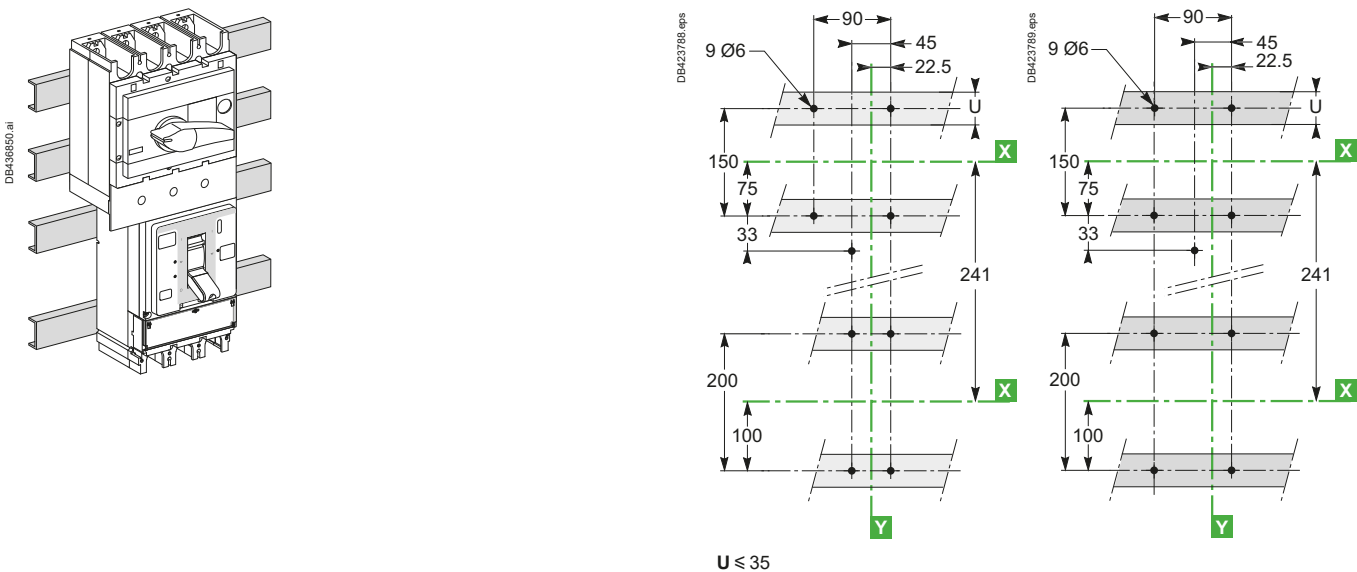

ComPacT NSX Dimensions and Mounting

Motor Mechanism Module for ComPacT NSX100 to 630

Dimensions

3P

4P

Fixed Circuit Breaker

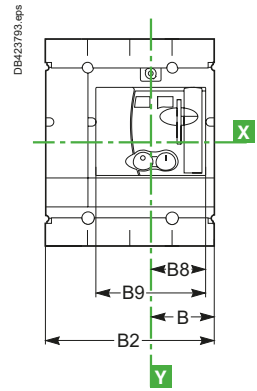
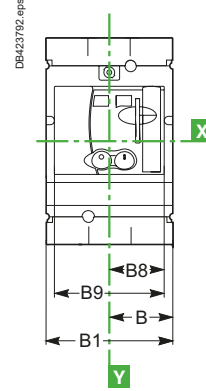
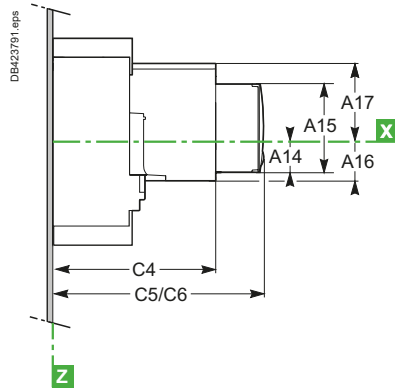
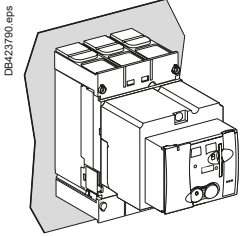

C5: without keylock
C6: with keylock

Plug-in Circuit Breaker

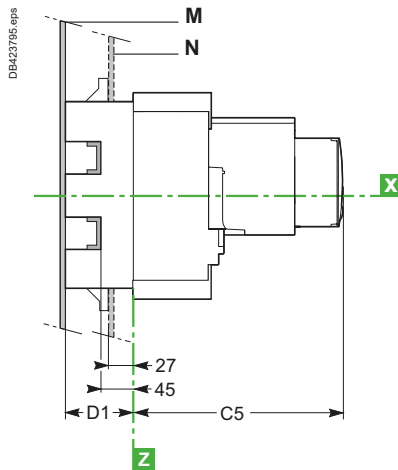
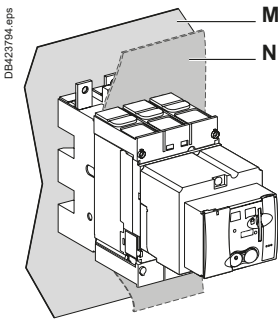

Withdrawable Circuit Breaker

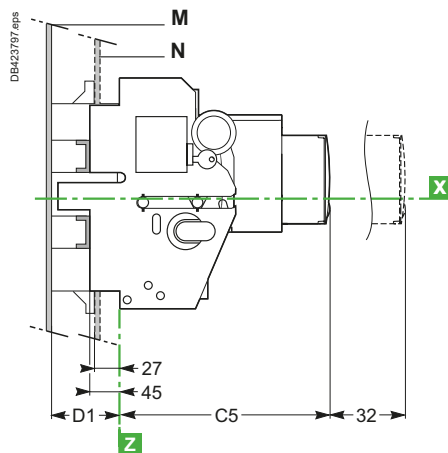
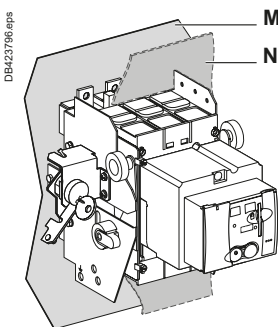

Type	A14	A15	A16	A17	B	B1	B2	B8	B9	C4	C5	C6	D1
NSX100/160/250	27.5	73	34.5	62.5	52.5	105	140	45.5	91	143	182	209.5	75
NSX400/630	40	123	52	100	70	140	185	61.5	123	215	256	258	100



ComPacT NSX Dimensions and Mounting

Direct Rotary Handle for ComPacT NSX100 to 630

Dimensions

3P

4P

Fixed Circuit Breaker

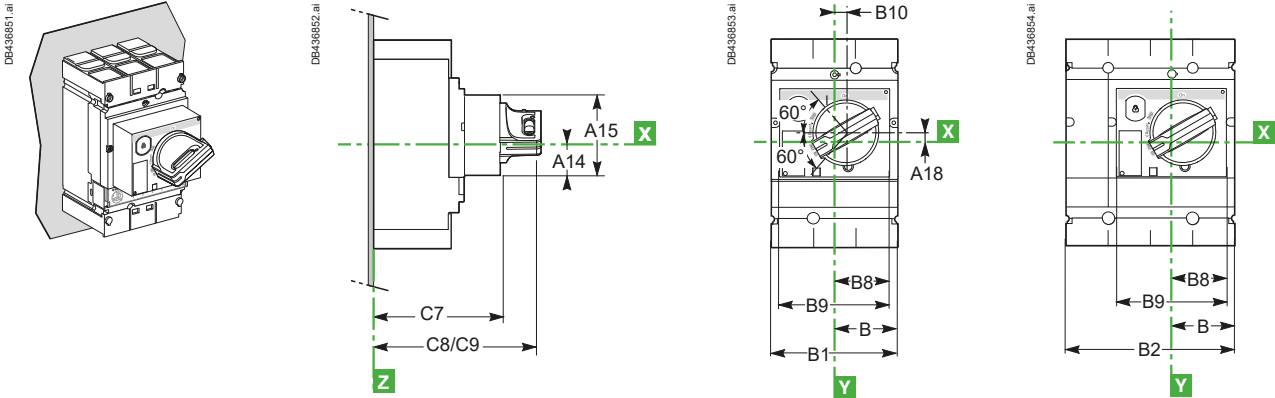

C8: without keylock
C9: with keylock

Plug-in Circuit Breaker



E

Withdrawable Circuit Breaker

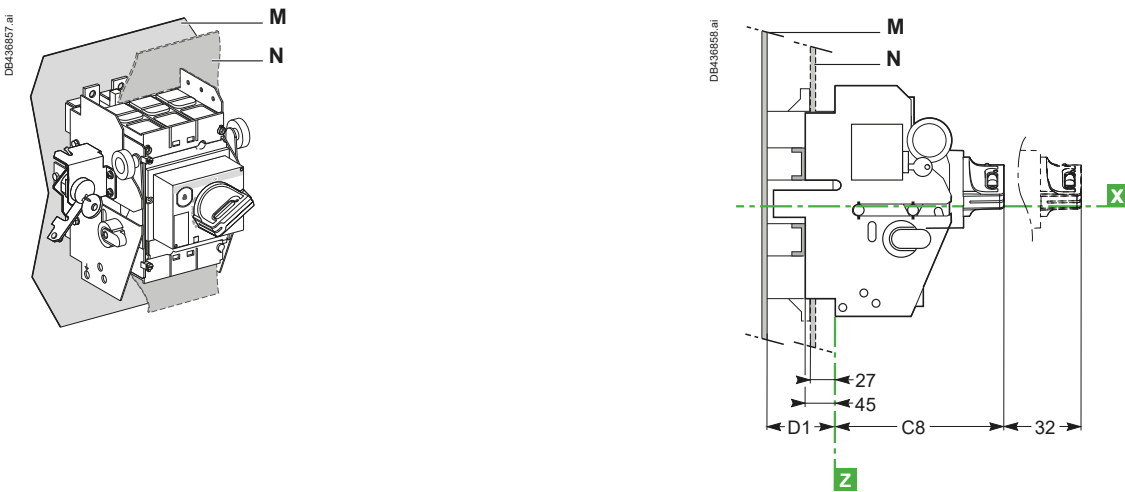

Type	A14	A15	A18	B	B1	B2	B8	B9	B10	C7	C8	C9	D1
NSX100/160/250	27.5	73	9	52.5	105	140	45.5	91	9.25	121	158.5	167.5	75
NSX400/630	40	123	24.6	70	140	185	61.5	123	5	145	182.5	191.5	100

ComPacT NSX Dimensions and Mounting

MCC and CNOMO Type Direct Rotary Handles for ComPacT NSX100 to 630 Fixed Version

Dimensions

MCC Type Direct Rotary Handle

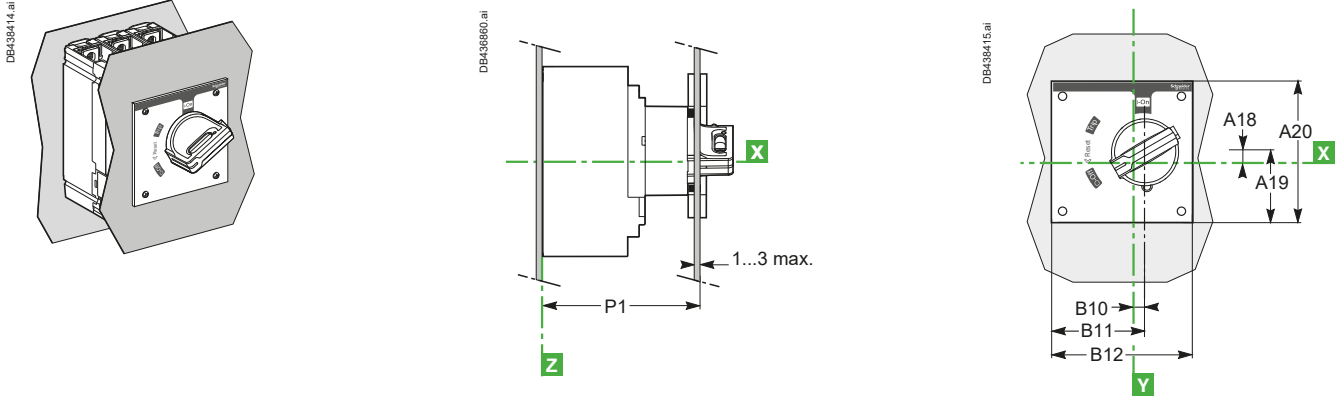

CNOMO Type Direct Rotary Handle

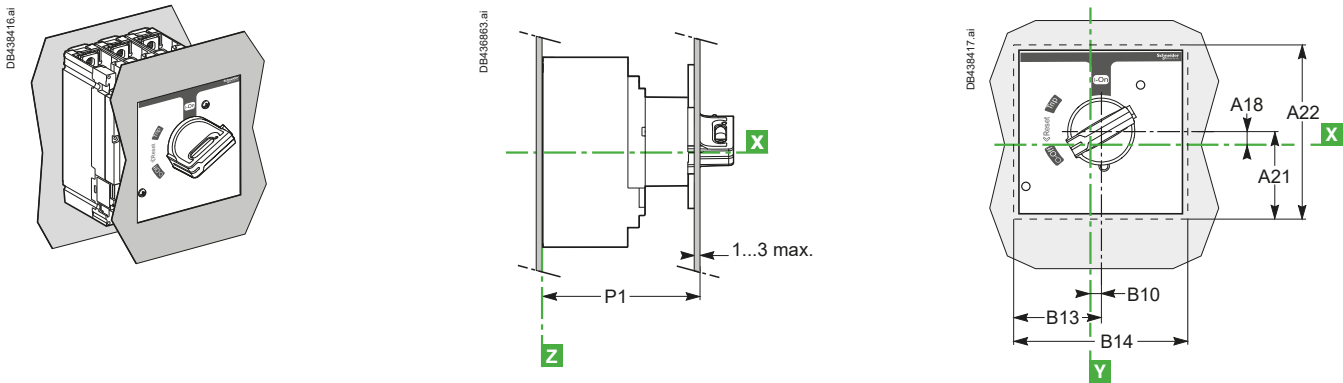

Front-Panel Cutout

NSX100 to 250

NSX400/630

MCC Type Direct Rotary Handle

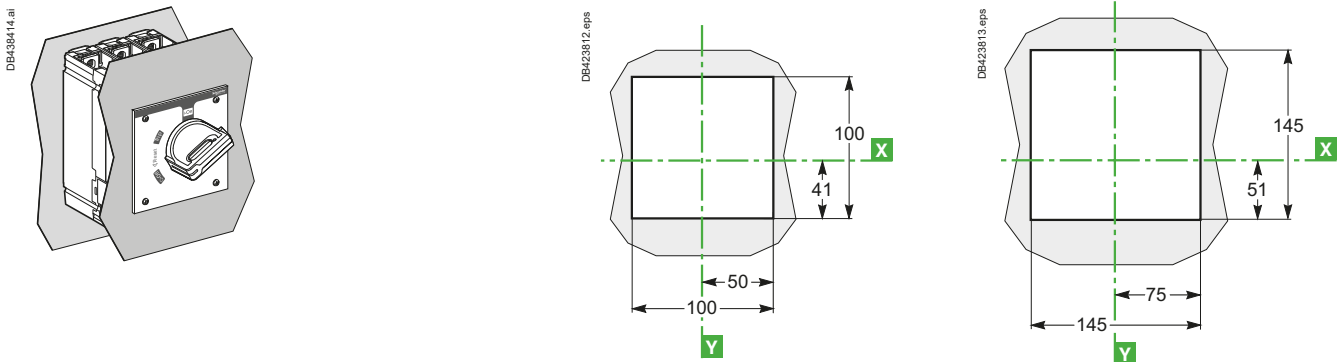

CNOMO Type Direct Rotary Handle

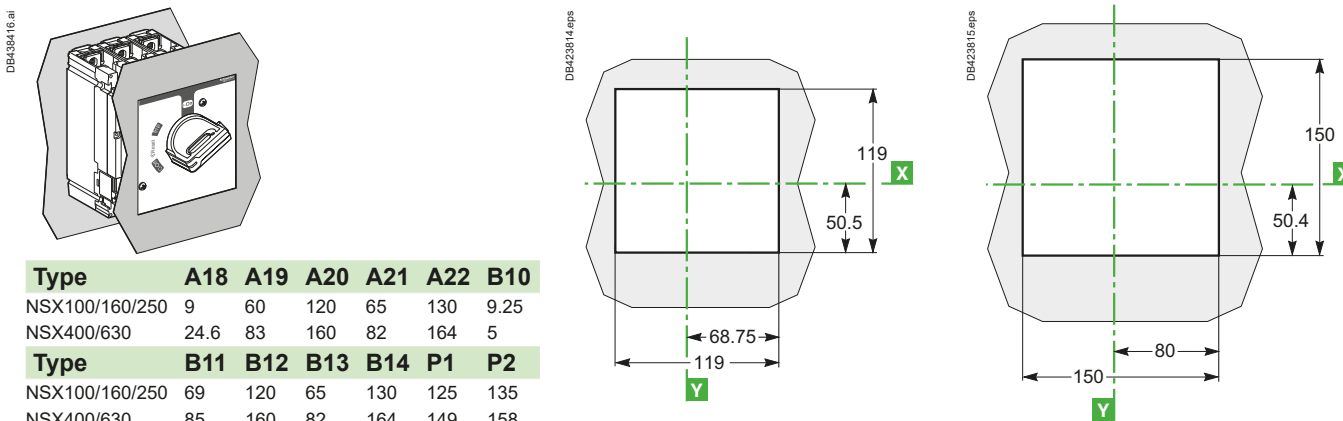

Type	A18	A19	A20	A21	A22	B10
NSX100/160/250	9	60	120	65	130	9.25
NSX400/630	24.6	83	160	82	164	5
Type	B11	B12	B13	B14	P1	P2
NSX100/160/250	69	120	65	130	125	135
NSX400/630	85	160	82	164	149	158



ComPacT NSX Dimensions and Mounting

Extended Rotary Handle for ComPacT NSX100 to 630

Dimensions

Fixed and Plug-in Circuit Breakers

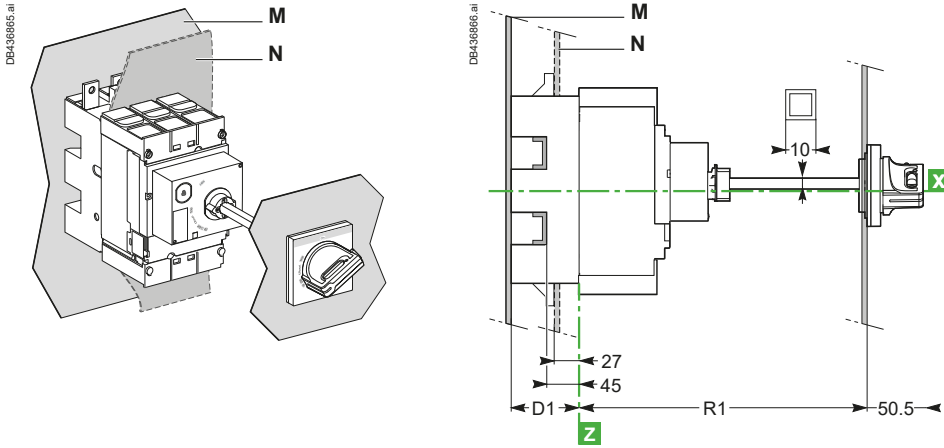

Cutout for shaft (mm)

Type	R1
NSX100/160/250	min. 171 max. 600
NSX400/630	min. 195 max. 600

Withdrawable Circuit Breaker

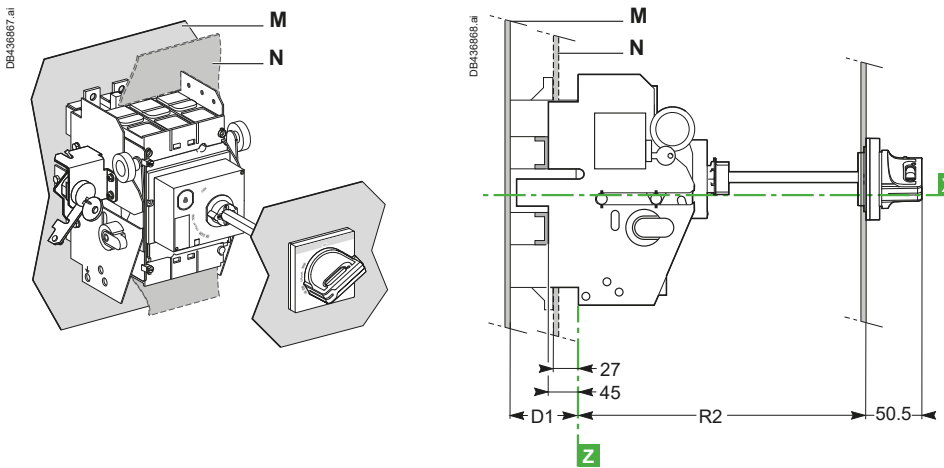

Cutout for shaft (mm)

Type	R2
NSX100/160/250	min. 248 max. 600
NSX400/630	min. 272 max. 600

Dimensions and Front-Panel Cutout

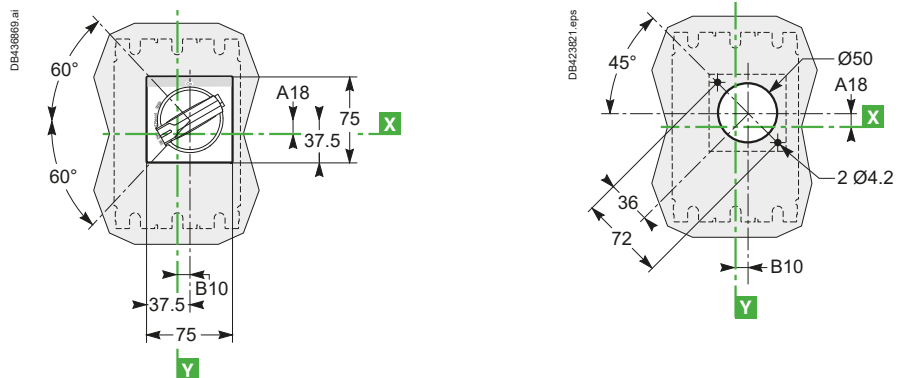

Type	A18	B10	D1
NSX100/160/250	9	9.25	75
NSX400/630	24.6	5	100

ComPacT NSX Dimensions and Mounting

Indication and Measurement Modules for ComPacT NSX100 to 630 Fixed Version

Dimensions of Circuit Breaker with Current-Transformer/PowerLogic PowerTag NSX Module

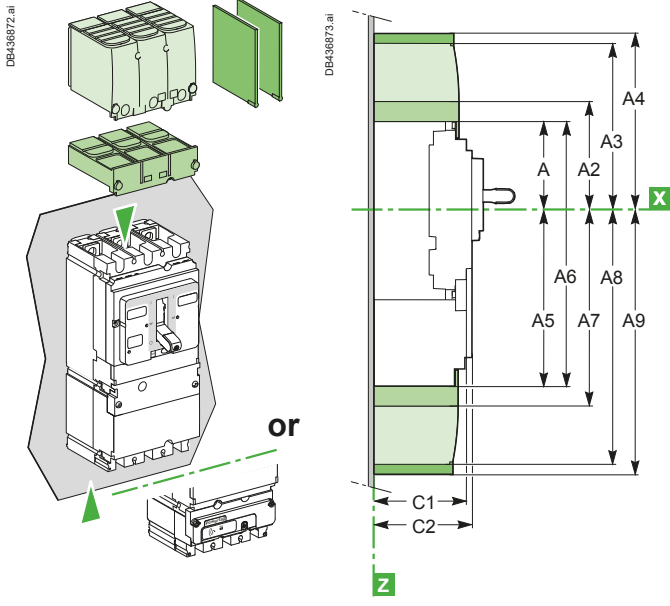

Mounting

On Backplate

NSX100 to 250 2/3P

NSX400/630 3P

NSX100 to 630 4P

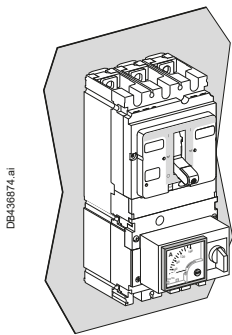

[1] The ØT holes are required for rear connection only. For two-pole circuit breakers, the middle holes are not required.

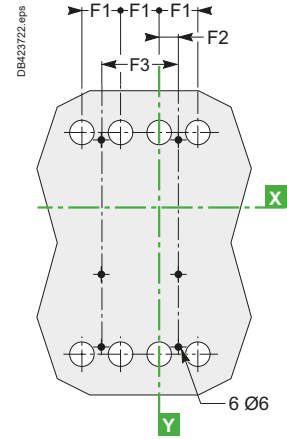
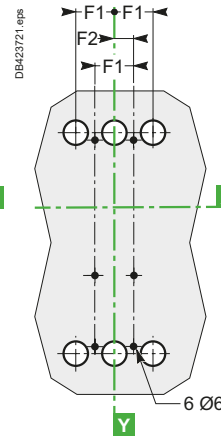
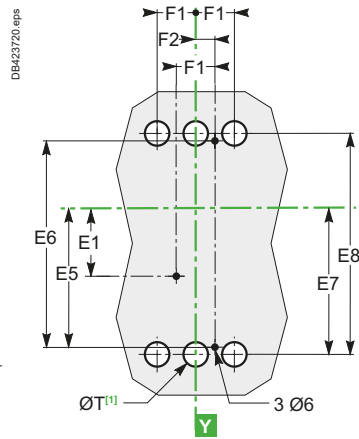

On Rails

2/3P

3P

4P

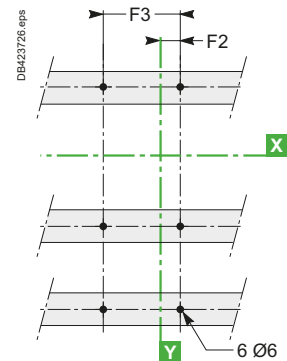
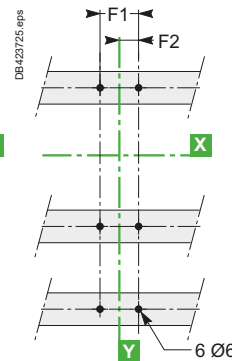
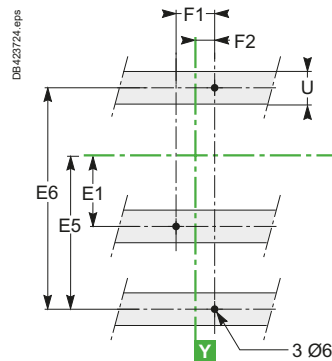
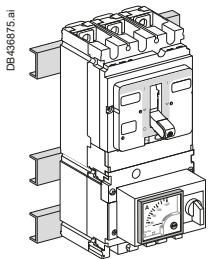

Type	A	A2	A3	A4	A5	A6	A7	A8	A9	C1	C2	C11	E1	E5	E6	E7	E8	F1
NSX100/160/250	80.5	94	145	178.5	155.5	236	169	220	253.5	81	86	137	62.5	137.5	200	145	215	35
NSX400/630	127.5	142.5	200	237	227.5	355	242.5	300	337	95.5	110	162	100	200	300	213.5	327	45
Type	F2	F3	ØT	U	Type	A5	A6	A7	A8	A9	E5	E6	E7	E8				
NSX100/160/250	17.5	70	24	≤ 32	NSX100/160/250 with PowerTag NSX	120.5	201	134	185	219.5	102.5	165	110	180				
NSX400/630	22.5	90	32	≤ 35	NSX400/630 with PowerTag NSX	192.5	320	207.5	265	302.5	165	265	178.5	192				

ComPacT NSX Dimensions and Mounting

One-Piece Spreader for ComPacT NSX100 to 250 Fixed Version

Dimensions

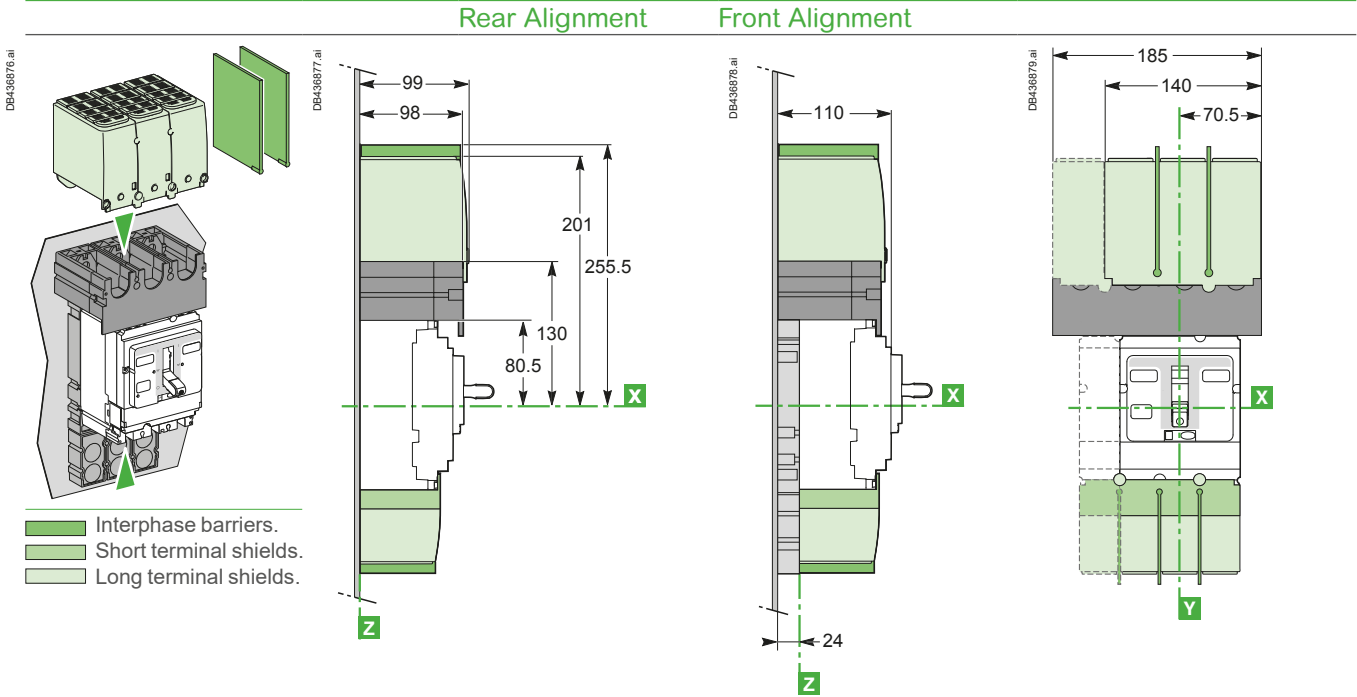

Mounting

Rear Alignment

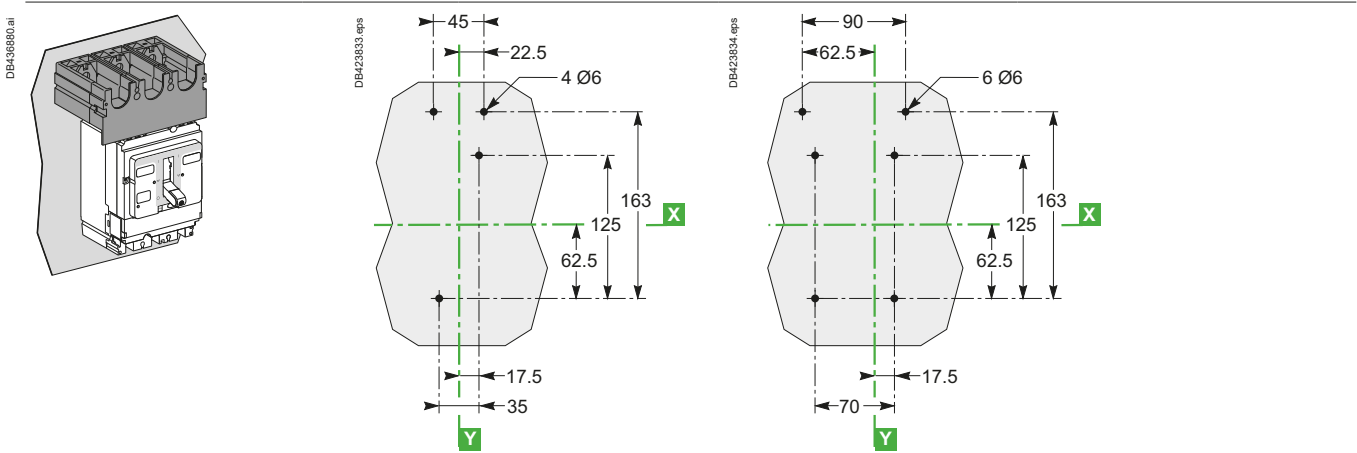

Front Alignment

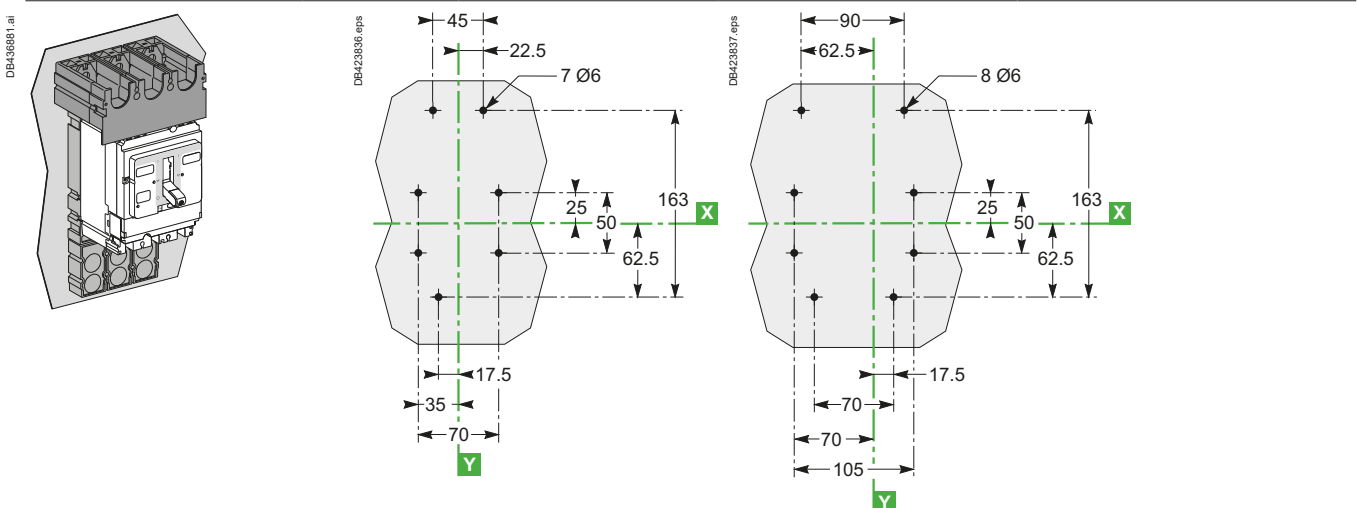

ComPacT NSX Dimensions and Mounting External Modules

I/O (Input/Output) Application Module

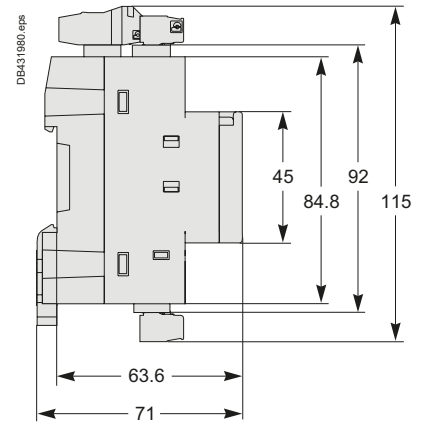
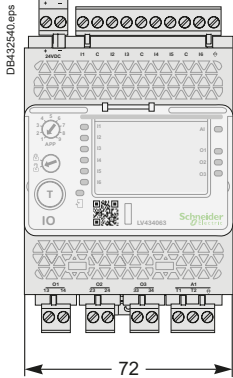

IFM - Modbus-SL Interface

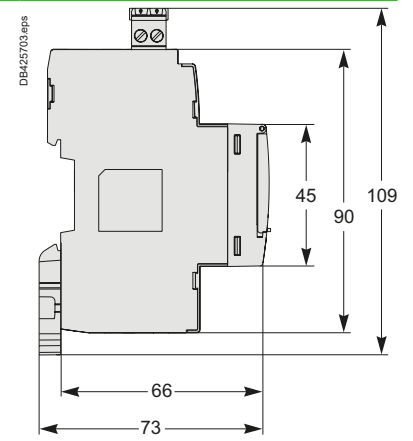
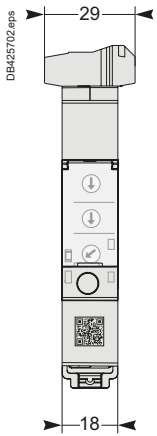

IFE - Ethernet Interface

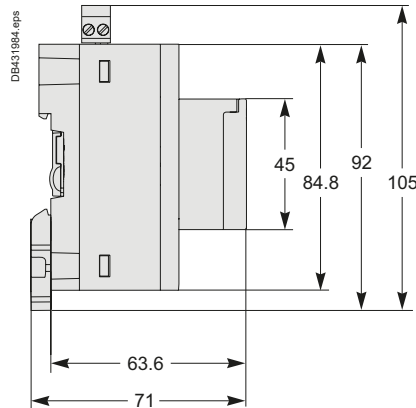
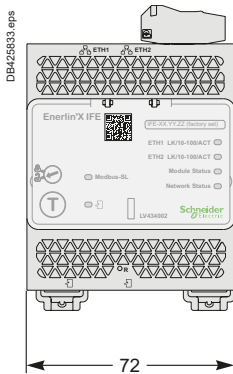

Com'X 500/510

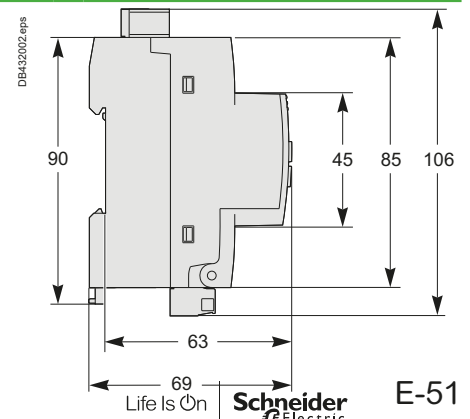
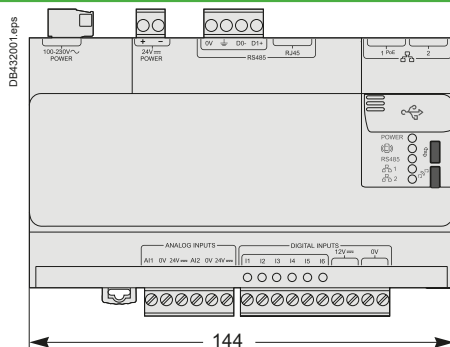

ComPacT NSX Dimensions and Mounting

FDM121 Switchboard Display

Dimensions

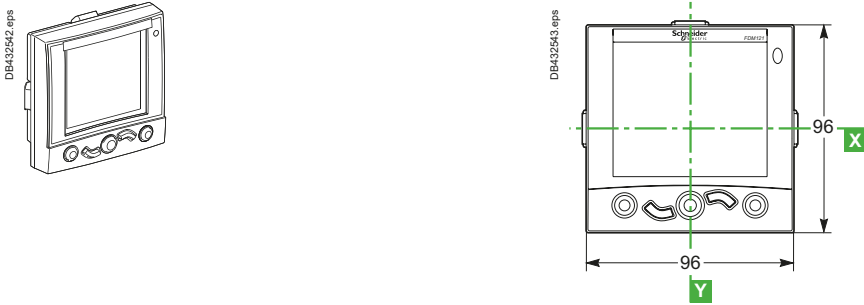

Mounting

Through Panel

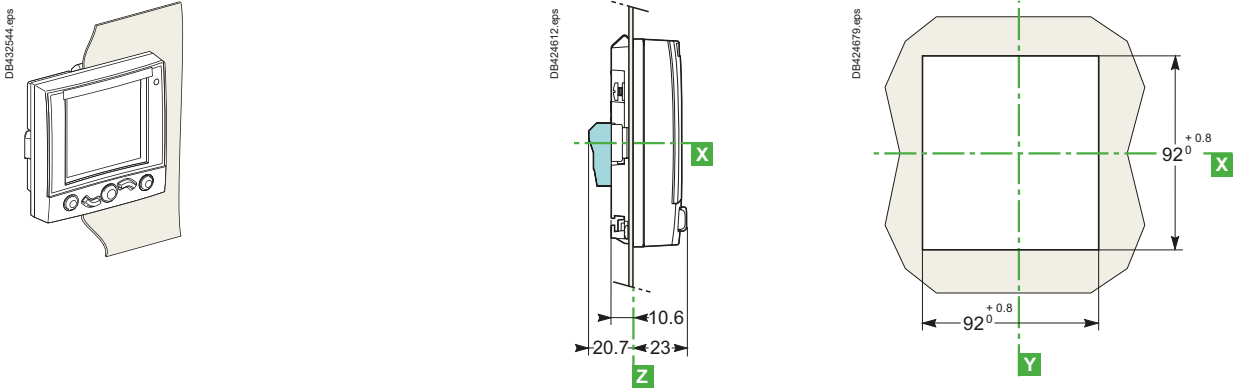

On Panel

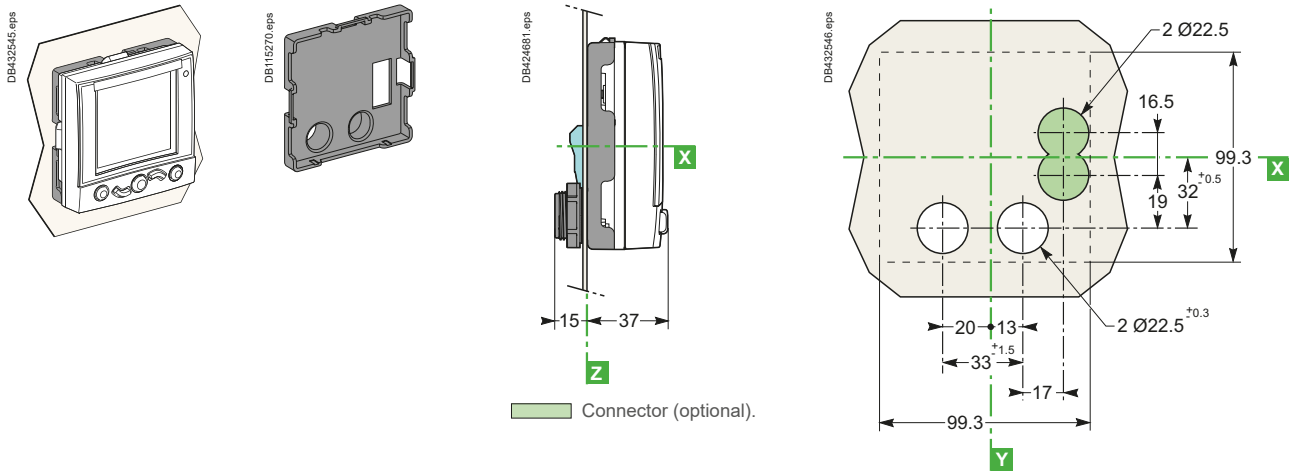

E

ComPacT NSX Dimensions and Mounting

FDM128 Switchboard Display

Dimensions

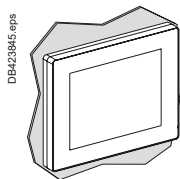

DB423845.eps

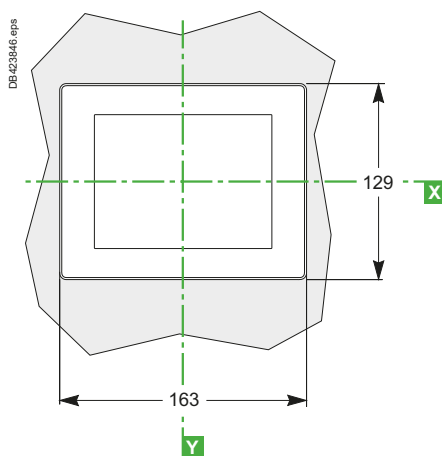

Mounting

On Panel

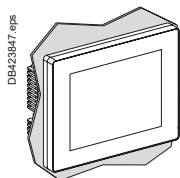

DB423847.eps

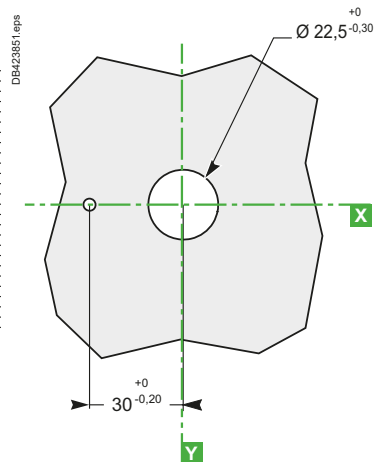
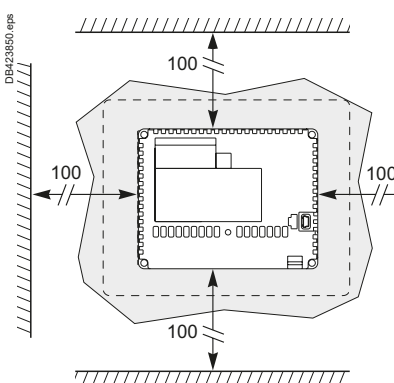
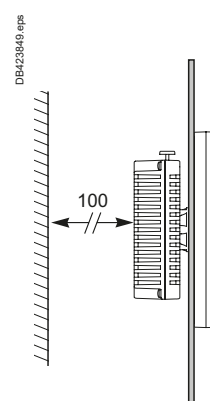
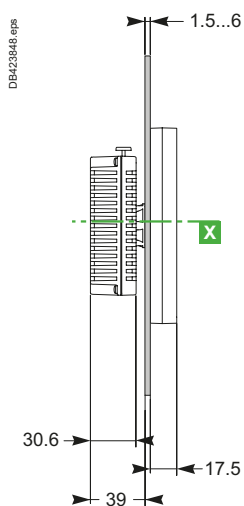

ComPacT NSX Front-Panel Accessories

ComPacT NSX100 to 630

IP30 Front-Panel Escutcheons

For Toggle, Rotary Handle or Motor Mechanism Module

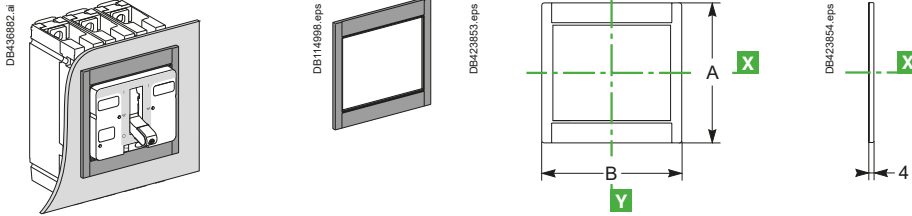

For Toggle or Rotary Handle with Access to Trip Unit

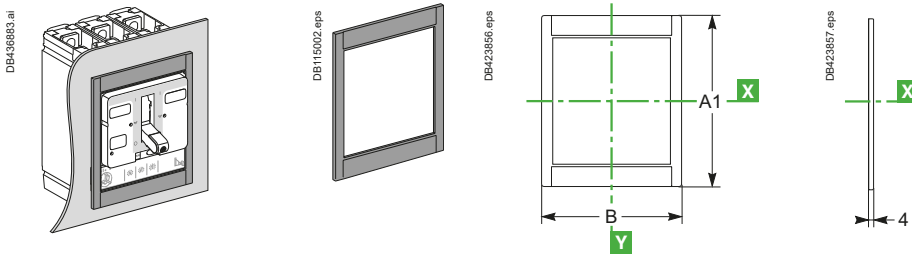

For VigiPacT Add-on

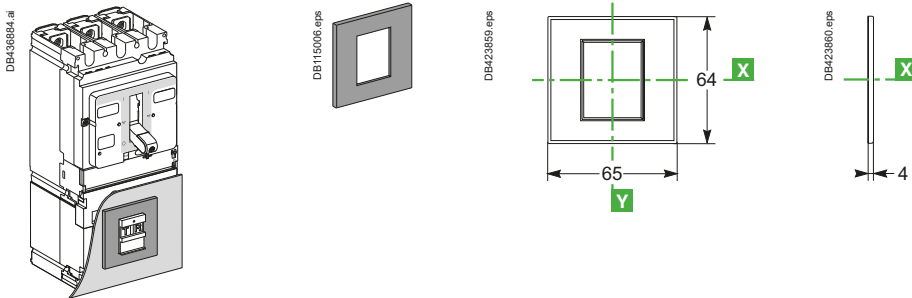

IP40 Front-Panel Escutcheons

For Toggle, Rotary Handle or Motor Mechanism Module and Protection Collar

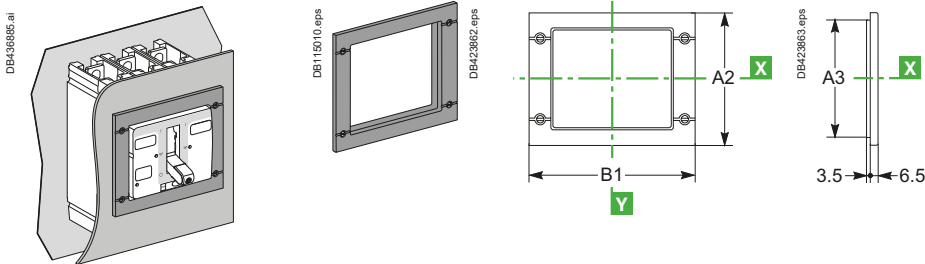

For VigiPacT Add-on with Protection Collar

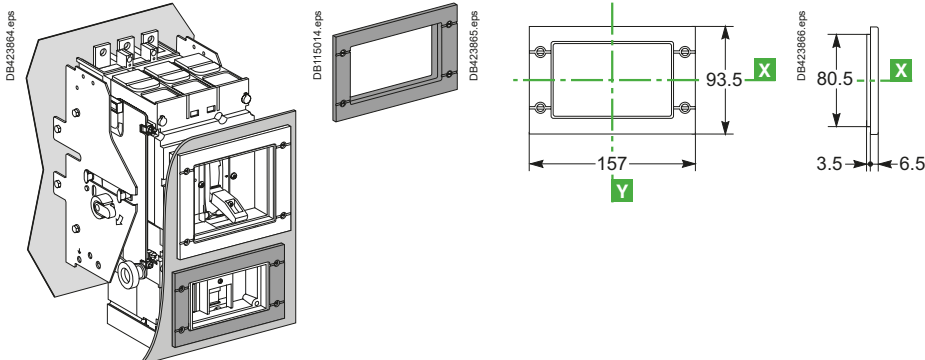

E

ComPacT NSX Front-Panel Accessories

ComPacT NSX100 to 630

IP40 Front-Panel Escutcheons (Cont.)

For VigiPacT Add-on

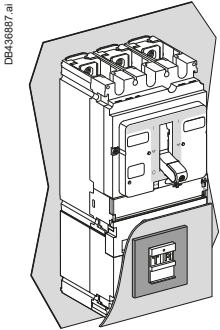

DB438887.ai

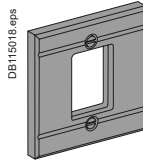

DB115018.eps

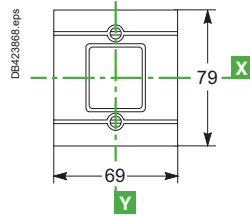

DB423888.eps

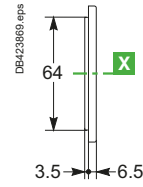

DB423889.eps

Protection Collars for IP40 Front-Panel Escutcheons

For Toggle

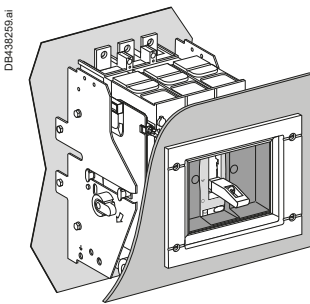

DB438259.ai

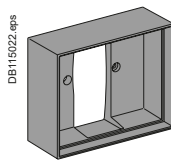

DB115022.eps

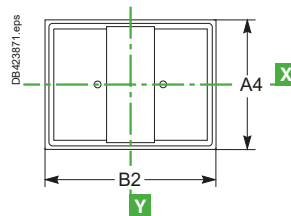

DB423871.eps

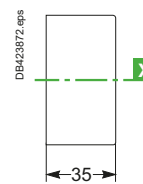

DB423872.eps

For VigiPacT Add-on

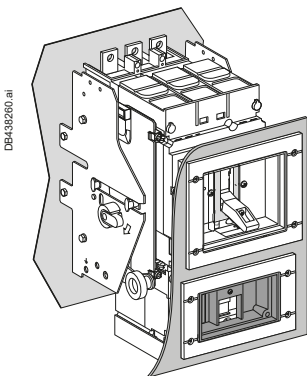

DB438260.ai

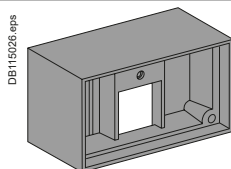

DB115026.eps

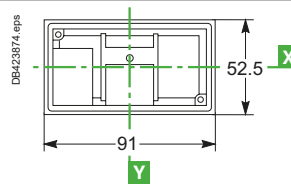

DB423874.eps

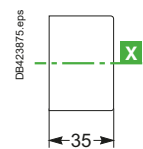

DB423875.eps

Circuit breaker with toggle or rotary handle.

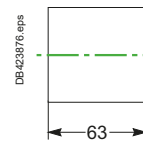

DB423876.eps

Circuit breaker with motor-mechanism module.

IP43 Toggle Cover

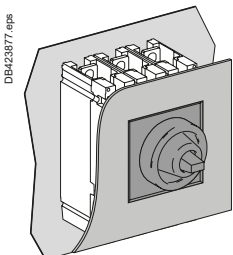

DB423877.eps

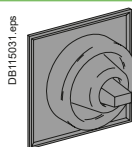

DB115031.eps

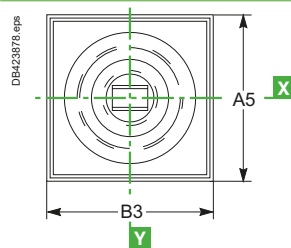

DB423878.eps

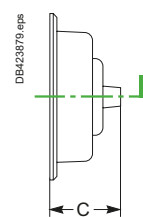

DB423879.eps

Type	A	A1	A2	A3	A4	A5	B	B1	B2	B3	C
NSX100/160/250	113	138	114	101	73	85	113	157	91	103	40
NSX400/630	163	211	164	151	122.5	138	163	189	122.5	138	60

ComPacT NSX Front-Panel Cutouts

ComPacT NSX100 to 630 Fixed Version

Bare Sheet Metal

NSX100 to 250

NSX400/630

For Toggle

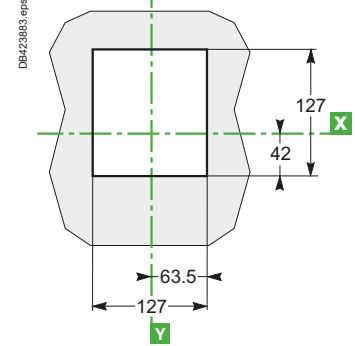
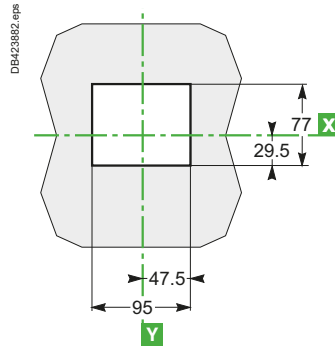
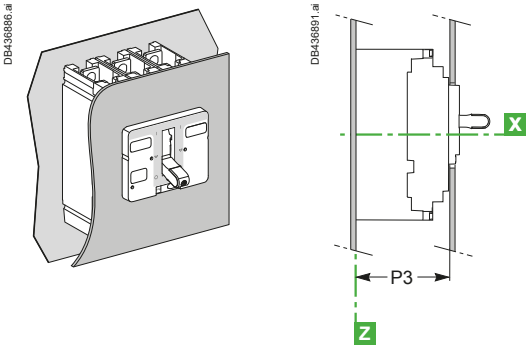

For Toggle with Access to Trip Unit

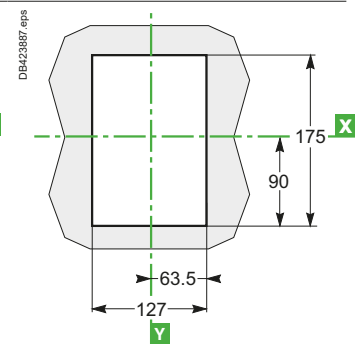
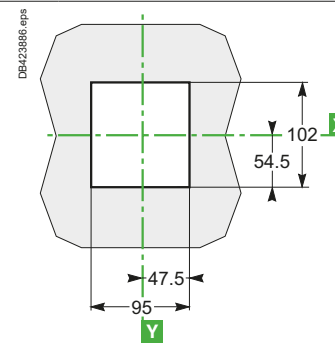
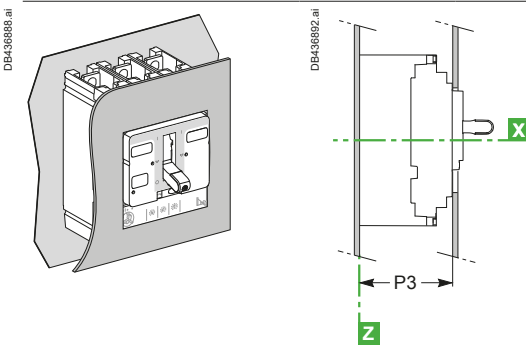

E

With IP30 Front-Panel Escutcheon

NSX100 to 250

NSX400/630

For Toggle

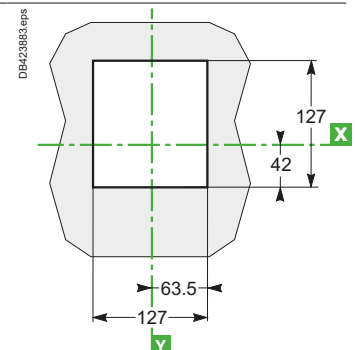
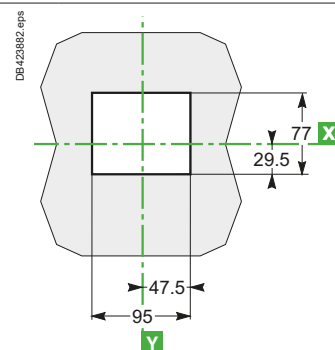
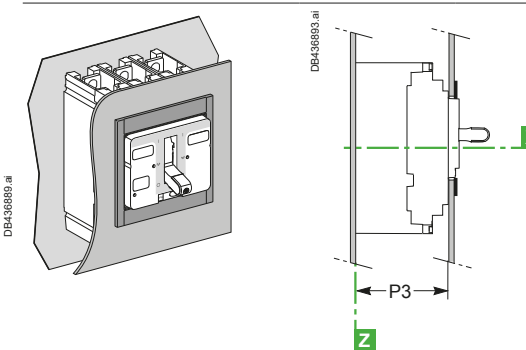

For Toggle with Access to Trip Unit

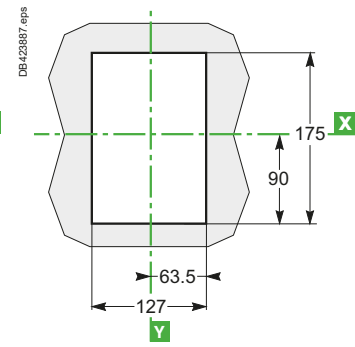
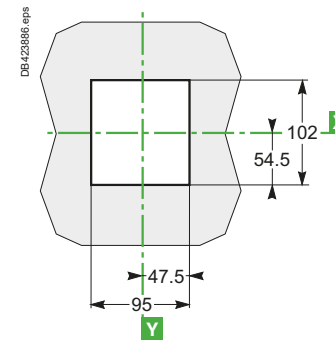
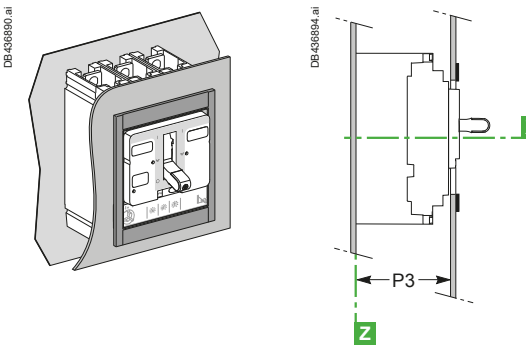

ComPacT NSX Front-Panel Cutouts

ComPacT NSX100 to 630 Fixed Version

With IP40 Front-Panel Escutcheon For Toggle

NSX100 to 250

NSX400/630

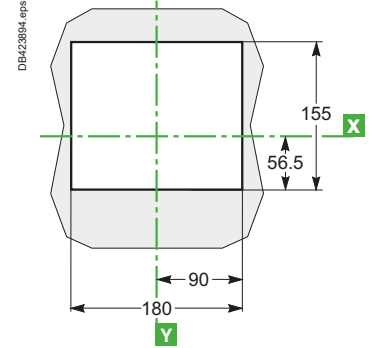
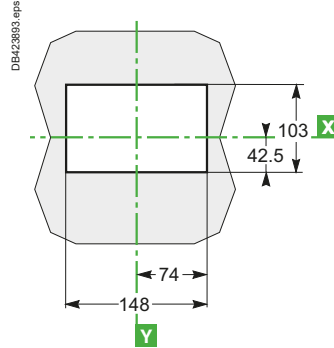
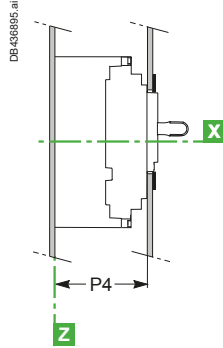
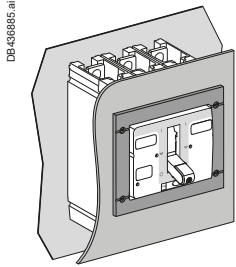

With IP43 Toggle Cover For Toggle

NSX100 to 250

NSX400/630

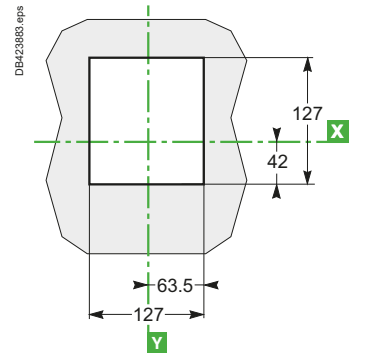
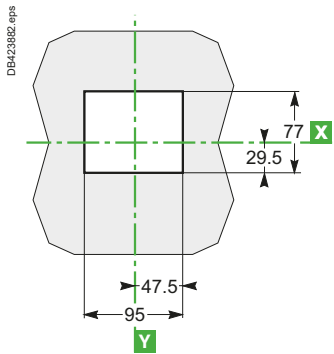
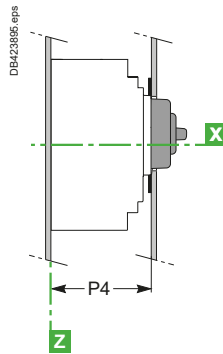
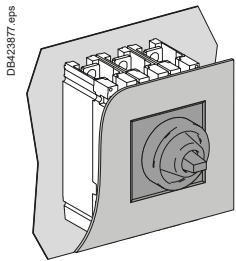

Type	P3	P4
NSX100/160/250	88	89
NSX400/630	112	113

Note: Door cutout dimensions are given for a device position in the enclosure where $D \geq 100 + (h \times 5)$ with respect to the door hinge.

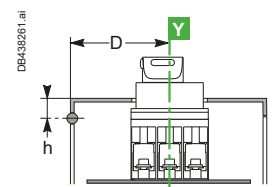

ComPacT NSX Front-Panel Cutouts

ComPacT NSX100 to 630 VigiPacT Add-on Fixed Version

Bare Sheet Metal

NSX100 to 250

NSX400/630

For Toggle

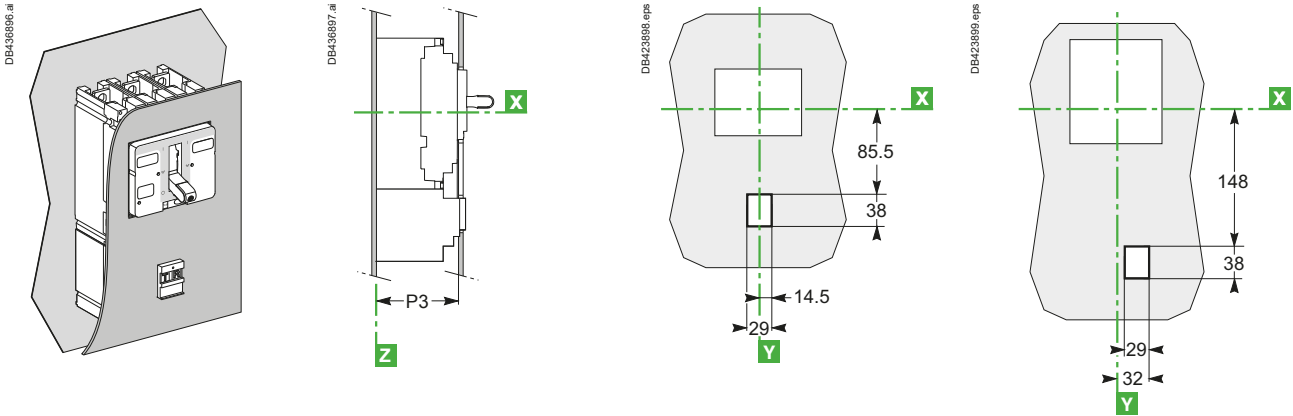

For Toggle with Access to Trip Unit

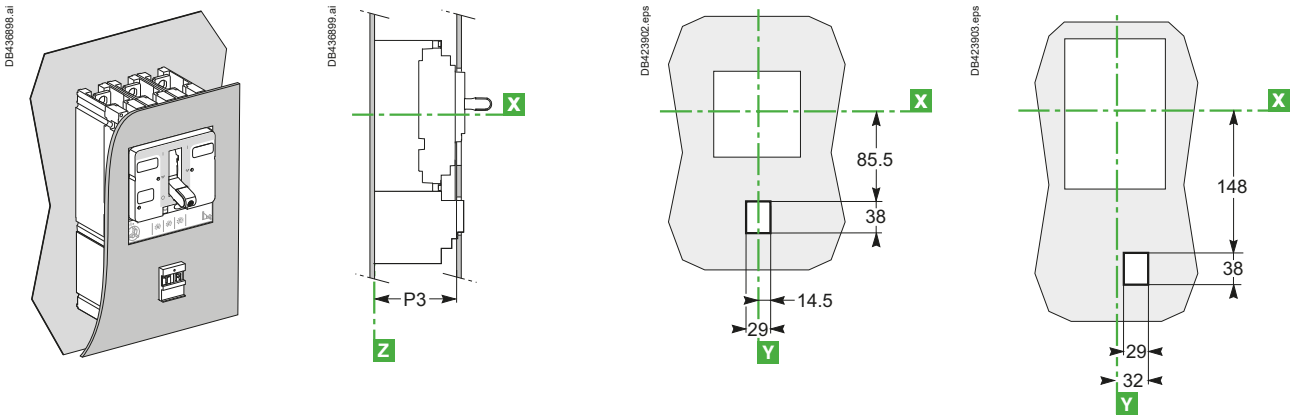

E

With IP30 Front-Panel Escutcheon

NSX100 to 250

NSX400/630

For Toggle

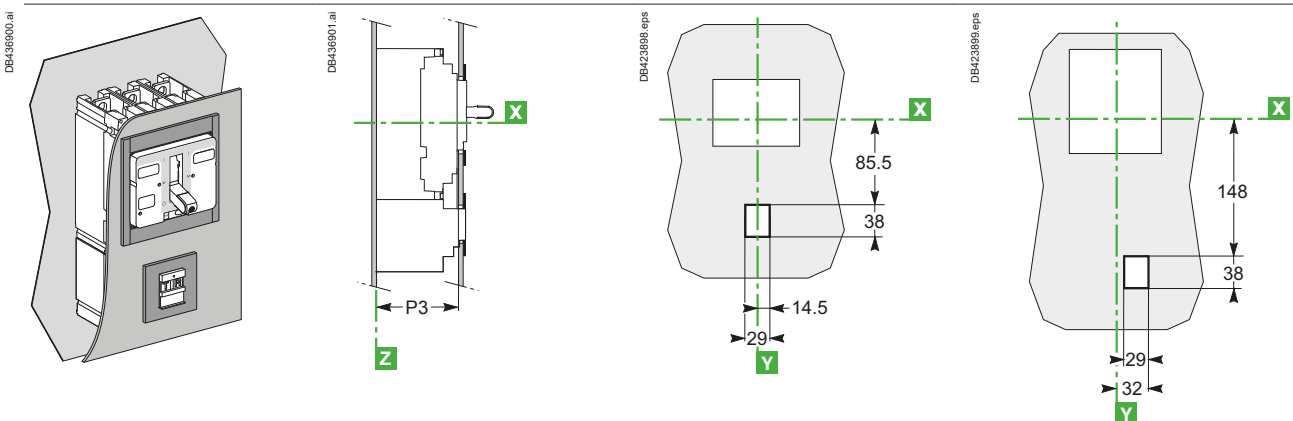

ComPacT NSX Front-Panel Cutouts

ComPacT NSX100 to 630 VigiPacT Add-on Fixed Version

With IP30 Front-Panel Escutcheon For Toggle with Access to Trip Unit

NSX100 to 250

NSX400/630

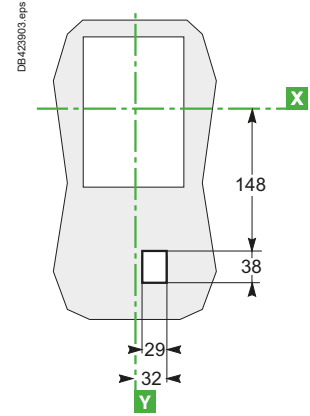
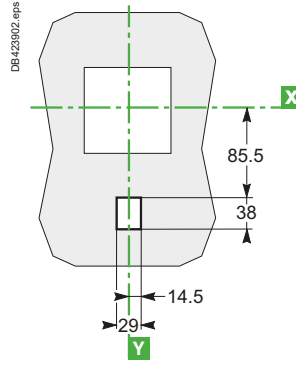
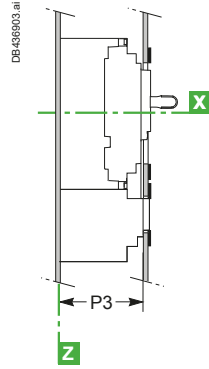
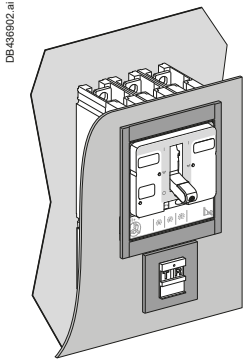

With IP40 Front-Panel Escutcheon For Toggle

NSX100 to 250

NSX400/630

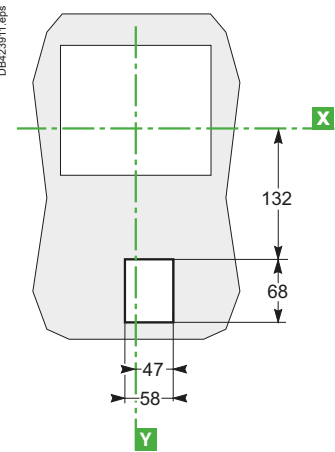
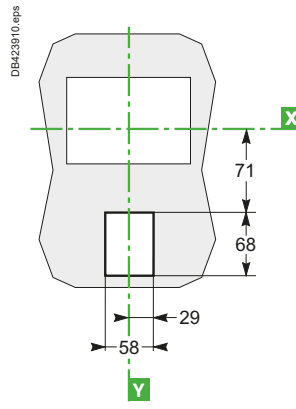
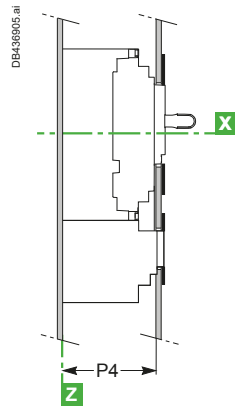
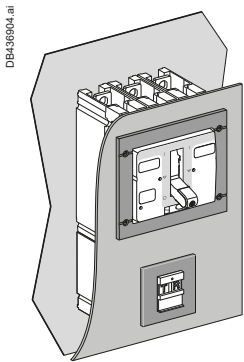

Type	P3	P4
NSX100/160/250	88	89
NSX400/630	112	113

Note: Door cutout dimensions are given for a device position in the enclosure where $\Delta \geq 100 + (h \times 5)$ with respect to the door hinge.

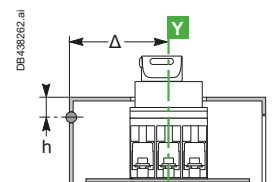

ComPacT NSX Front-Panel Cutouts

ComPacT NSX100 to 630 Plug-in and Withdrawable Versions

Plug-in Version

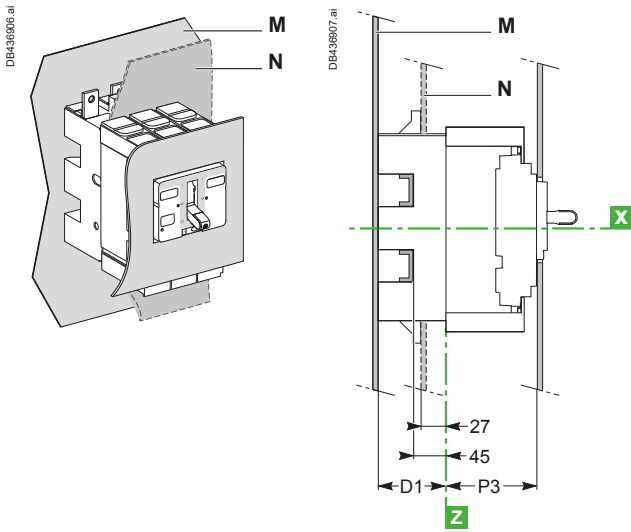

Bare sheet metal

See ComPacT NSX100 to 630 fixed version, [page E-56](#)

With IP30 front-panel escutcheon

See ComPacT NSX100 to 630 fixed version, [page E-56](#)

With IP40 front-panel escutcheon

See ComPacT NSX100 to 630 fixed version, [page E-57](#)

With toggle cover

See ComPacT NSX100 to 630 fixed version, [page E-57](#)

E

Withdrawable Version

NSX100 to 250

NSX400/630

With Protection Collar and IP40 Front-Panel Escutcheon

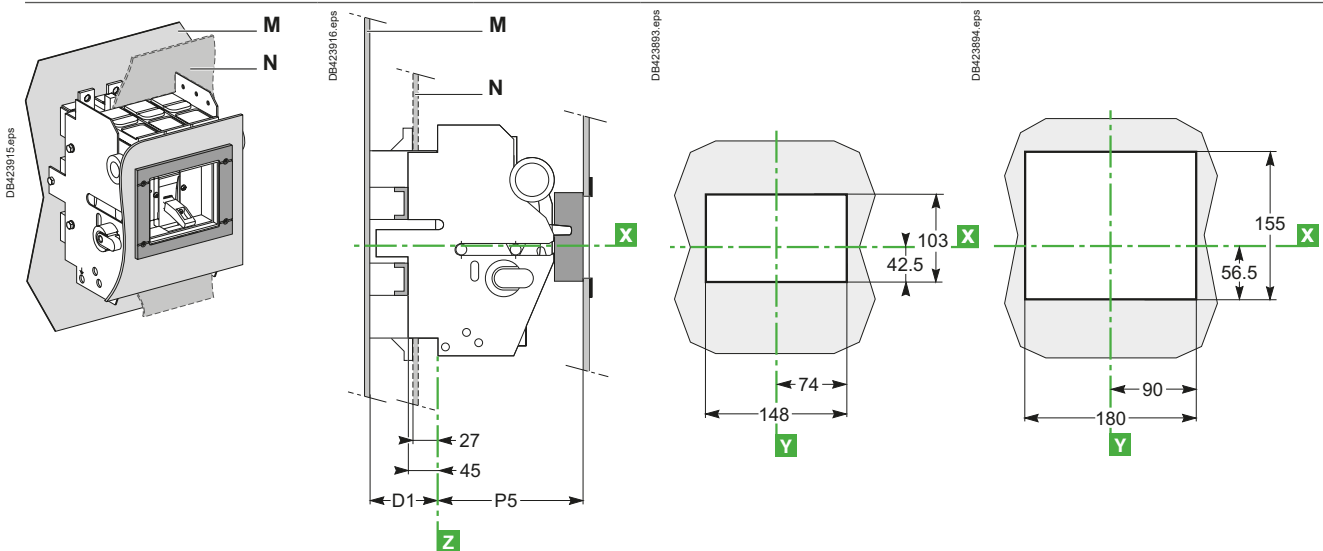

ComPacT NSX Front-Panel Cutouts

ComPacT NSX100 to 630 VigiPacT Add-on Plug-in and Withdrawable Versions

Plug-in Version

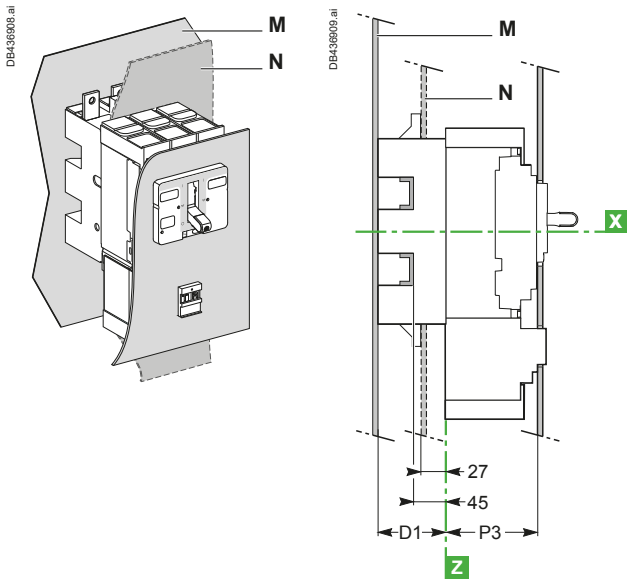

Bare sheet metal

See ComPacT NSX100 to 630 fixed version, [page E-58](#)

With IP30 front-panel escutcheon

See ComPacT NSX100 to 630 fixed version, [page E-58](#)

With IP40 front-panel escutcheon

See ComPacT NSX100 to 630 fixed version, [page E-59](#)

Withdrawable Version

NSX100 to 250

NSX400/630

With Protection Collar and IP40 Front-Panel Escutcheon

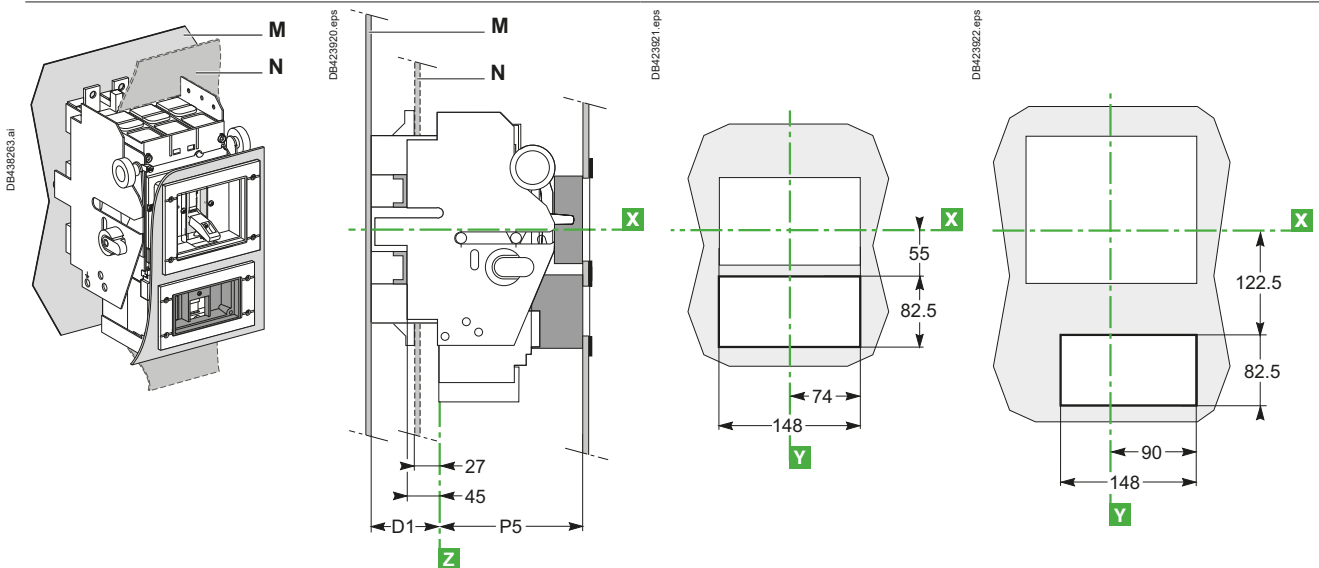

Type	D1	P3	P5
NSX100/160/250	75	88	123
NSX400/630	100	112	147

Note: Door cutout dimensions are given for a device position in the enclosure where $\Delta \geq 100 + (h \times 5)$ with respect to the door hinge.

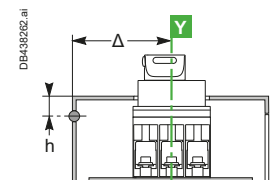

ComPacT NSX Front-Panel Cutouts

Visu Function for ComPacT NSX100 to 630 Fixed Version

ComPacT NSX100 to 250 with ComPacT INV100 to 250 Visu Function

Bare Sheet Metal

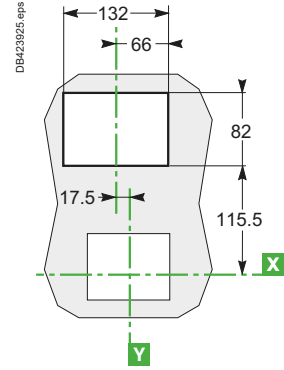
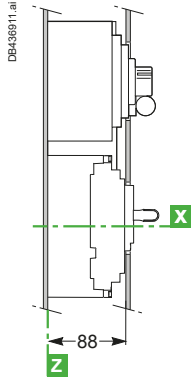
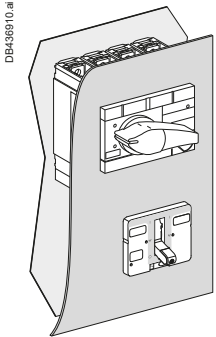

With IP40 Front-Panel Escutcheon

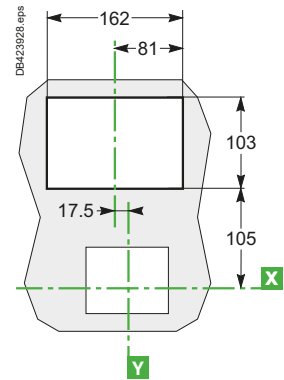
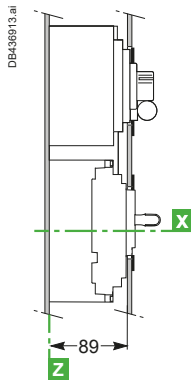
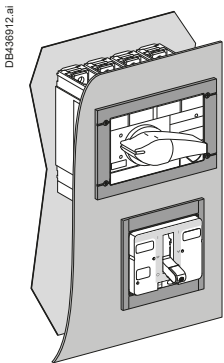

E

ComPacT NSX400/630 with ComPacT INV400 to 630 Visu Function

Bare Sheet Metal

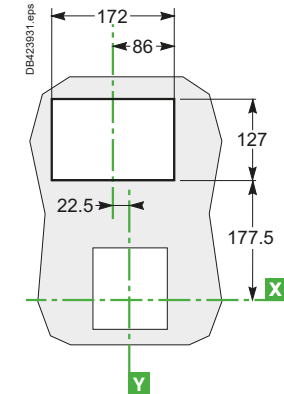
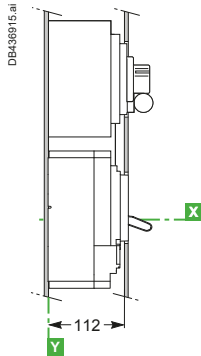
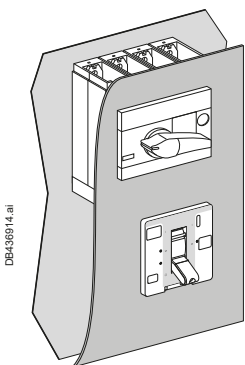

With IP40 Front-Panel Escutcheon

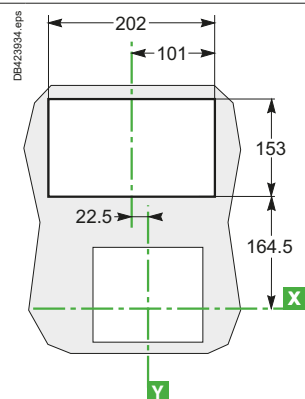
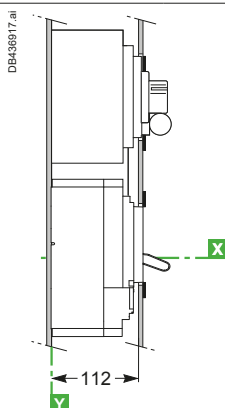
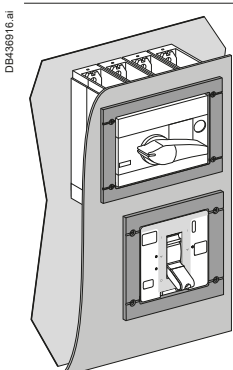

ComPacT NSX Front-Panel Cutouts

Motor Mechanism Module for ComPacT NSX100 to 630 with/without VigiPacT Add-on

Bare Sheet Metal

NSX100 to 250

NSX400/630

Fixed, Plug-in or Withdrawable Circuit Breaker

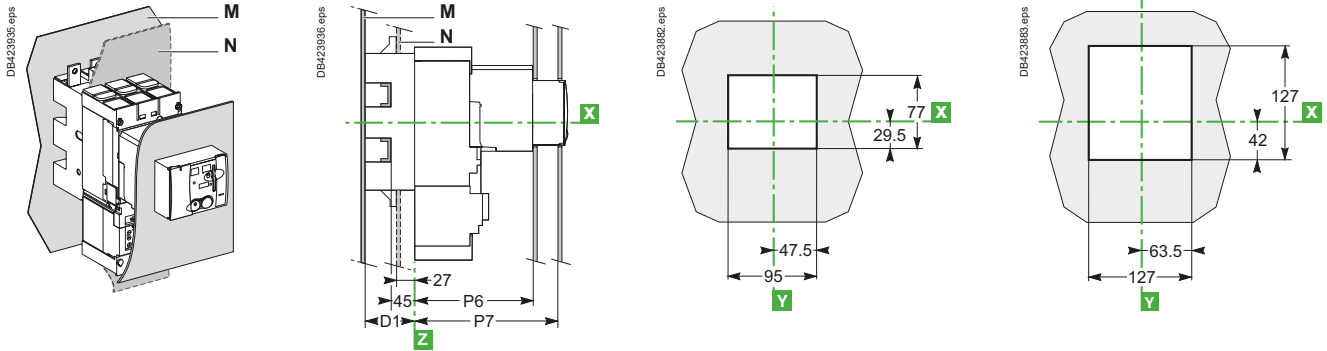

With IP30 Front-Panel Escutcheon

NSX100 to 250

NSX400/630

Fixed, Plug-in or Withdrawable Circuit Breaker

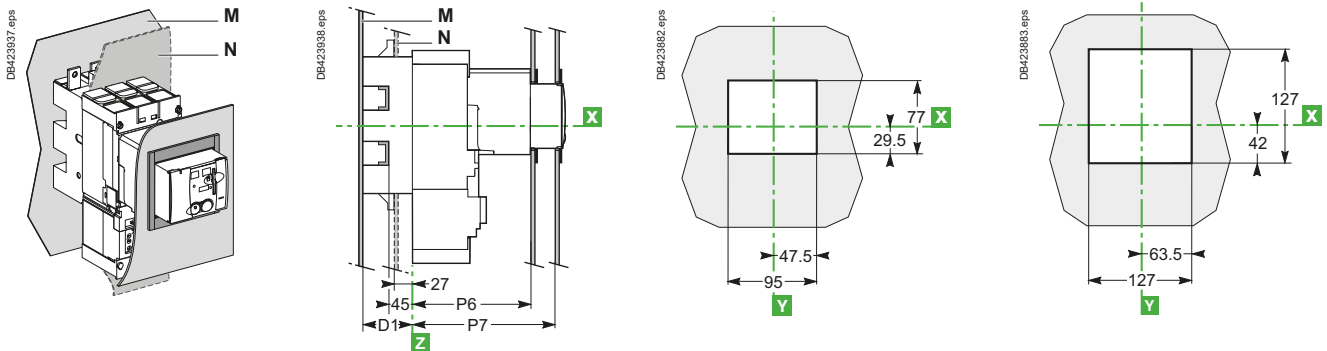

With IP40 Front-Panel Escutcheon

NSX100 to 250

NSX400/630

Fixed, Plug-in or Withdrawable Circuit Breaker without Access to VigiPacT Add-on

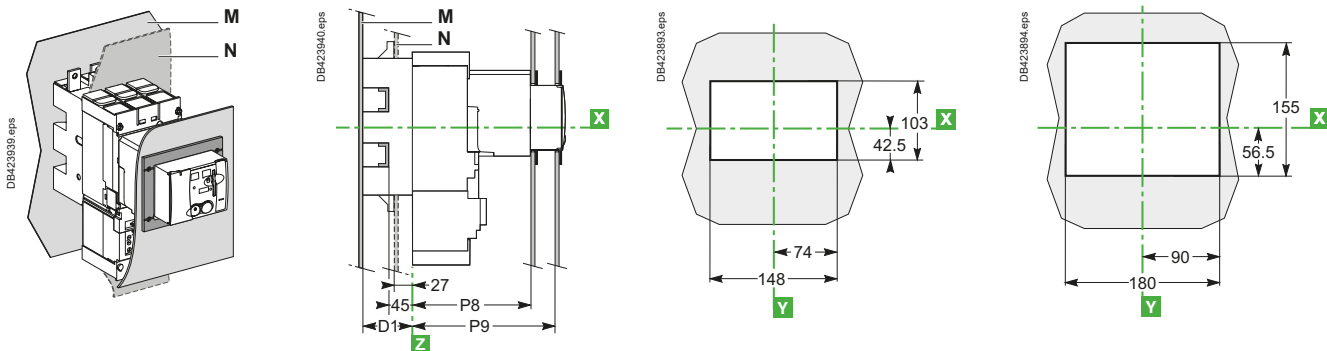

Fixed or Plug-in Circuit Breaker with Access to VigiPacT Add-on

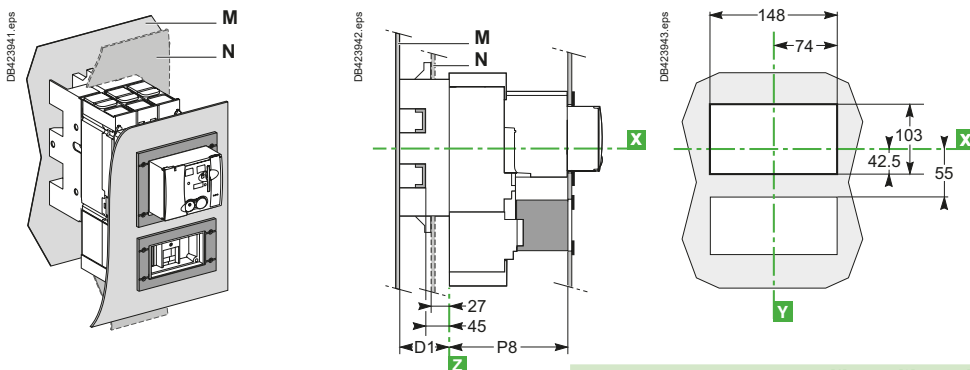

Type	D1	P6 [1]	P7 [2]	P8 [1]	P9 [2]
NSX100/160/250	75	145	177	146	178

[1] Plug-in version.

[2] Withdrawable version.

ComPacT NSX Front-Panel Cutouts

Direct Rotary Handle for ComPacT NSX100 to 630 with/without VigiPacT Add-on

Fixed or Plug-in Circuit Breakers

NSX100 to 250

NSX400/630

Bare Sheet Metal

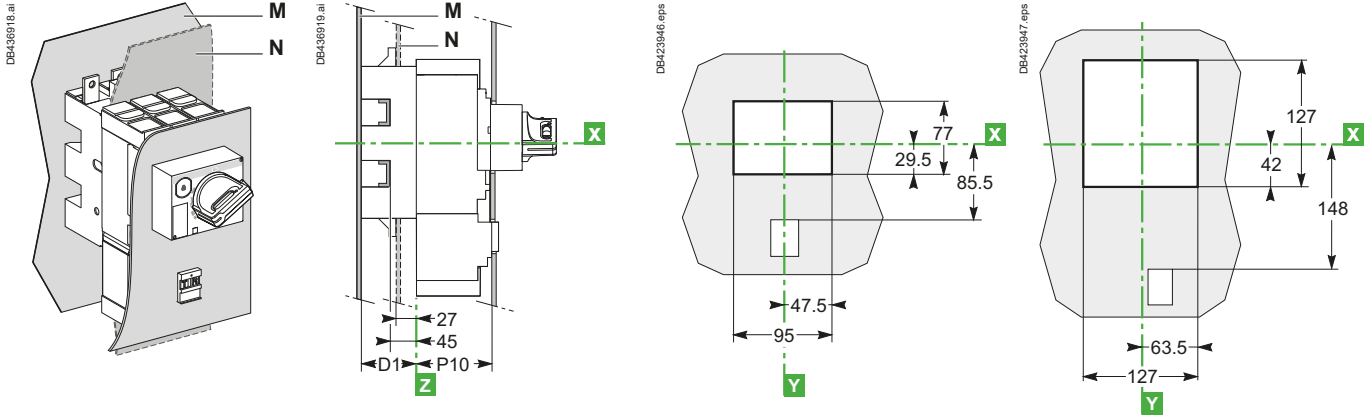

Bare Sheet Metal with Access to the Trip Unit

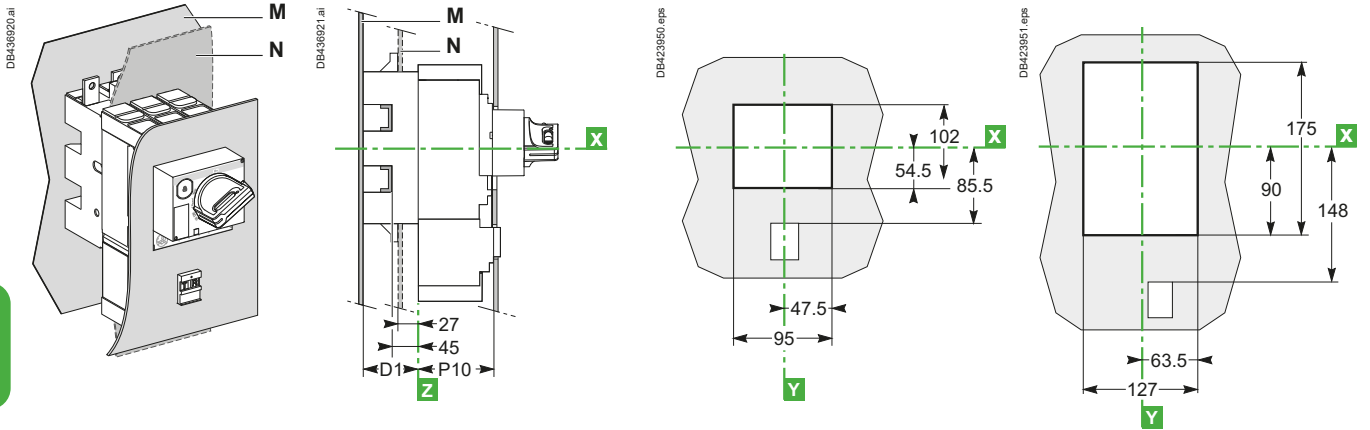

With IP30 Front-Panel Escutcheon

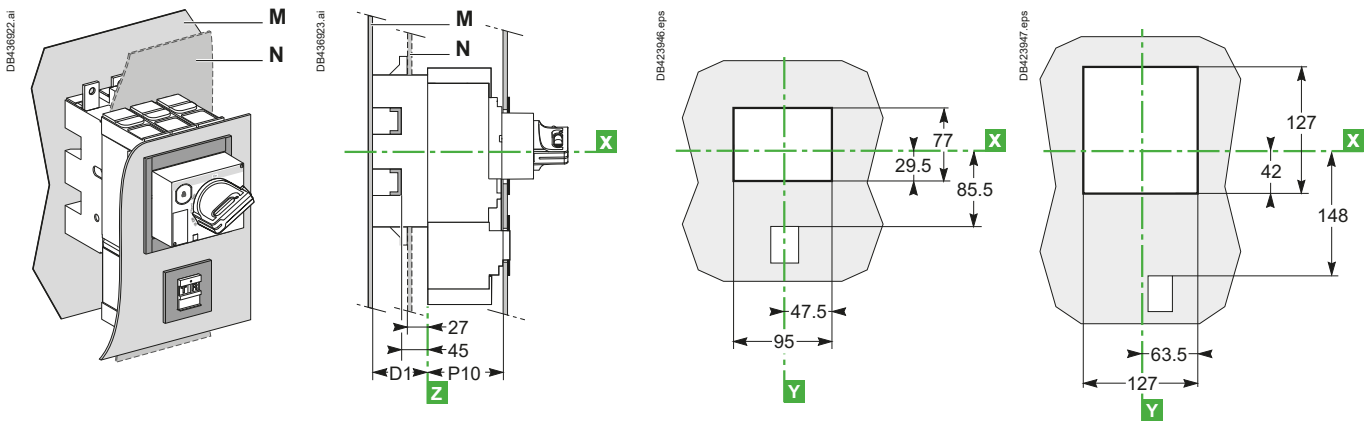

ComPacT NSX Front-Panel Cutouts

Direct Rotary Handle for ComPacT NSX100 to 630 with/without VigiPacT Add-on

Fixed or Plug-in Circuit Breakers

NSX100 to 250

NSX400/630

With IP30 Front-Panel Escutcheon with Access to the Trip Unit

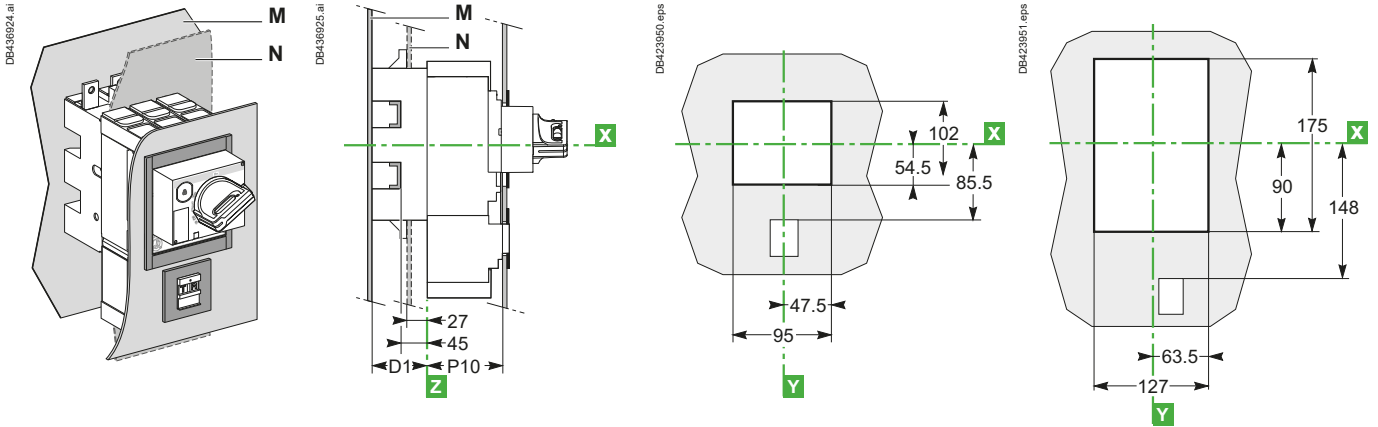

With IP40 Front-Panel Escutcheon

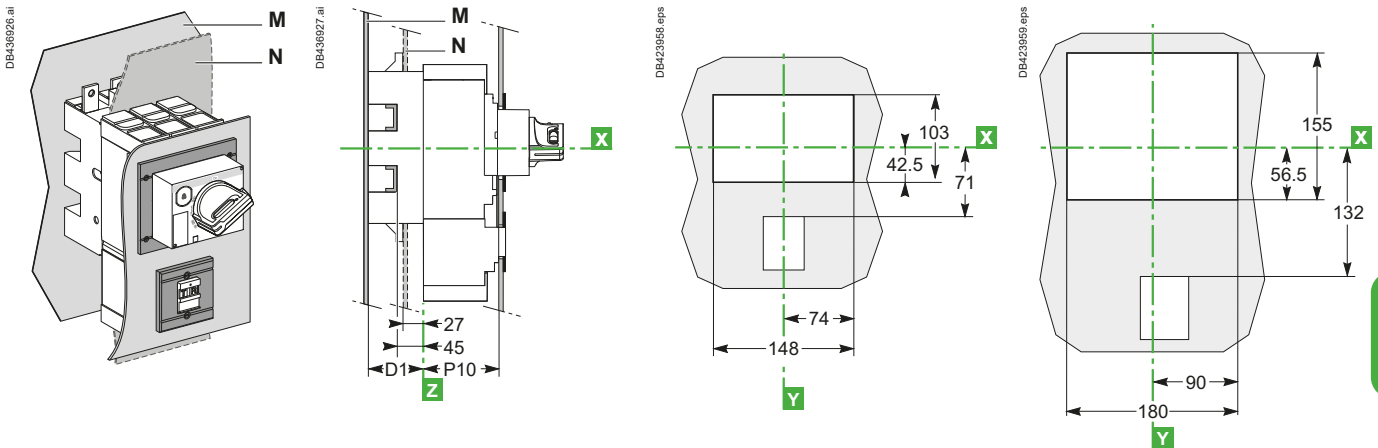

Fixed or Withdrawable Circuit Breakers

NSX100 to 250

NSX400/630

With IP40 Front-Panel Escutcheon

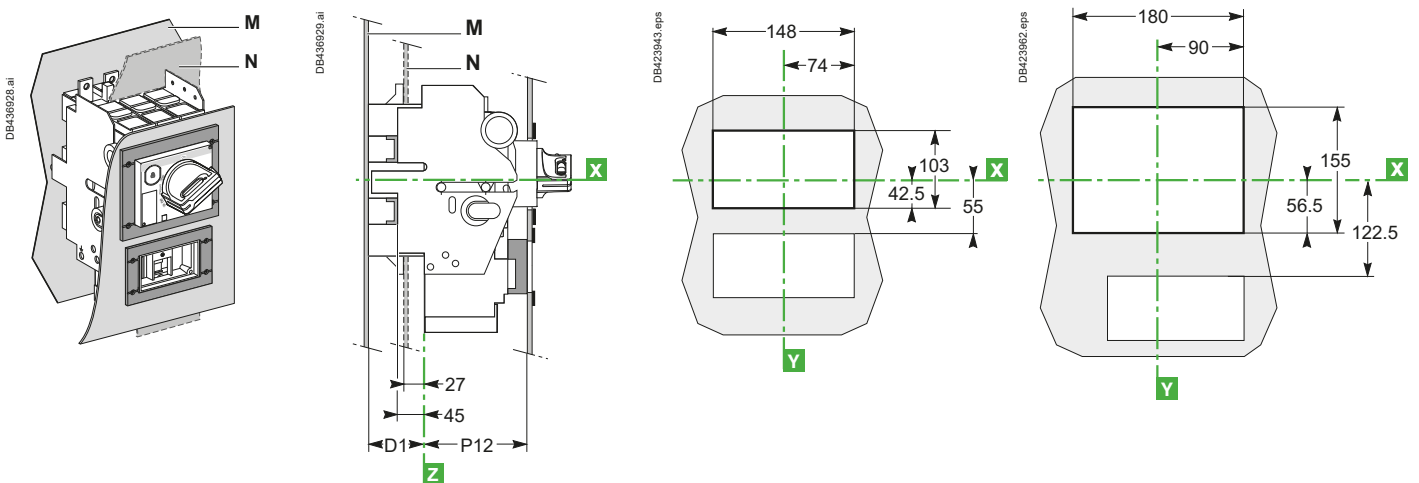

Type	D1	P10	P11	P12
NSX100/160/250	75	89	90	123
NSX400/630	100	112	113	147

ComPacT NSX Power Connections

ComPacT NSX100 to 630 with/without VigiPacT Add-on Fixed Version

Connection Locations

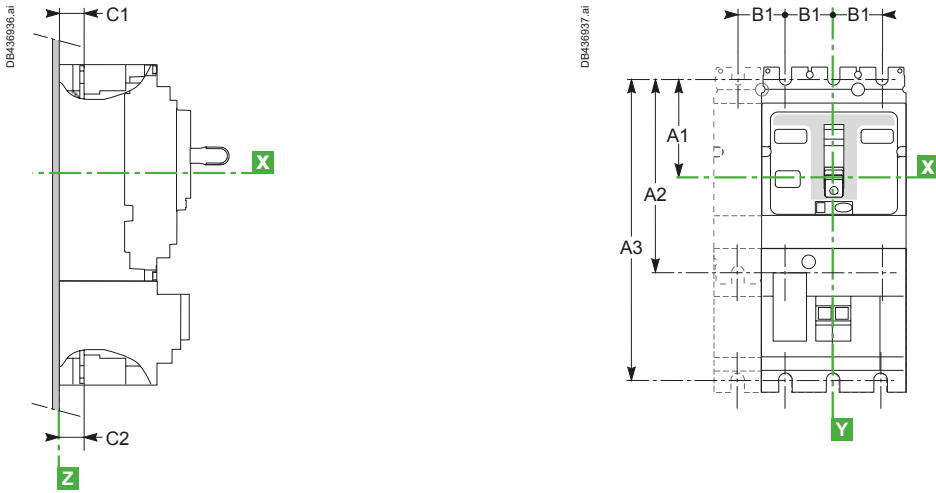

Type	A1	A2	B1	C1	C2
NSX100/160	70	140	35	19.5	19.5
NSX250	70	140	35	21.5	19.5
NSX400/630	113.5	227	45	26	26

Type	A1	A3	B1	C1	C2
NSX100/160 + Vigi	70	215	35	19.5	21.5
NSX250 + Vigi	70	215	35	21.5	21.5
NSX400/630 + Vigi	113.5	327	45	26	26

Front Connection without Accessories

NSX100 to 250

NSX400/630

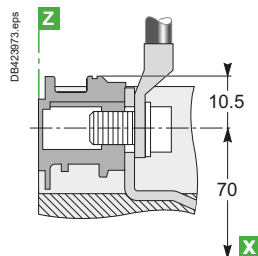
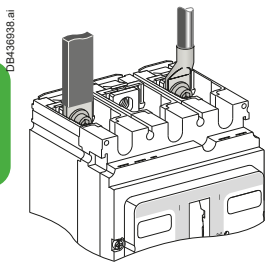

Cables with lugs/bars

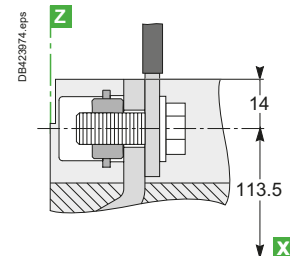

Bars/cables with lugs

Connection with Accessories

Long and Short Rear Connectors

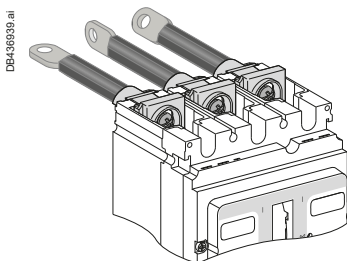

NSX100 to 250

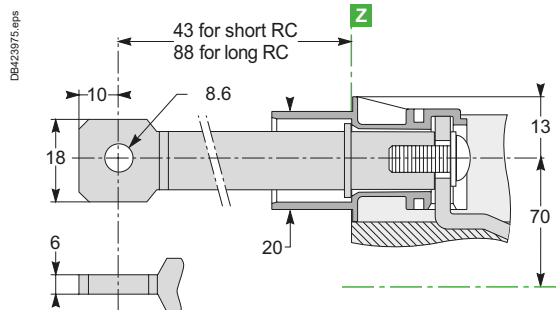

NSX400/630

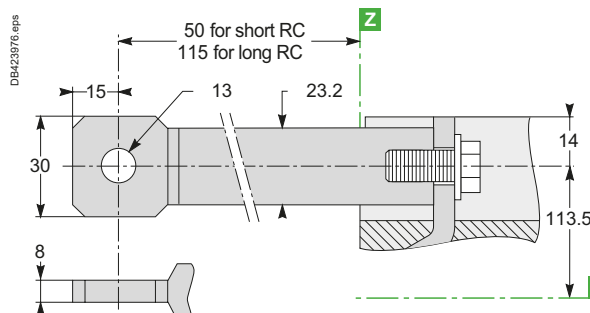

ComPacT NSX Power Connections

ComPacT NSX100 to 630 with/without VigiPacT Add-on Fixed Version

Connection with Accessories

Bare-Cable Connectors

NSX100 to 250

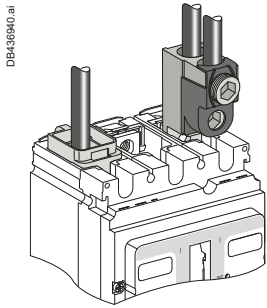

DB438940.ai

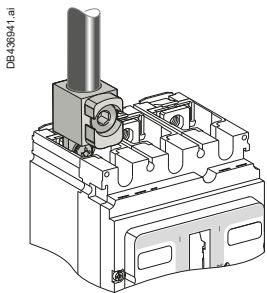

DB438941.ai

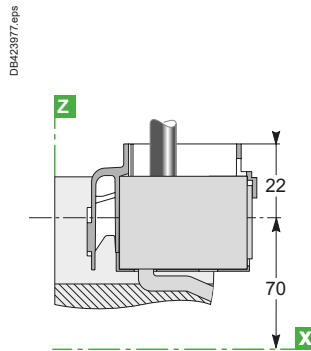

DB423977.eps

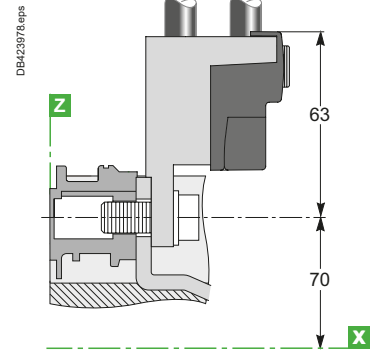

DB423978.eps

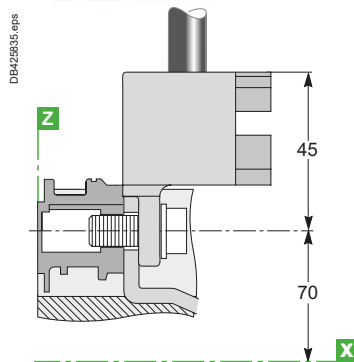

DB423835.eps

NSX400/630

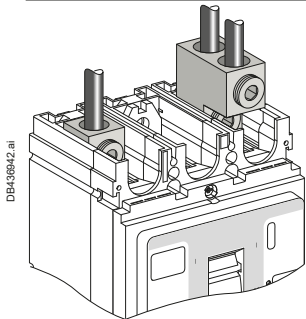

DB438642.ai

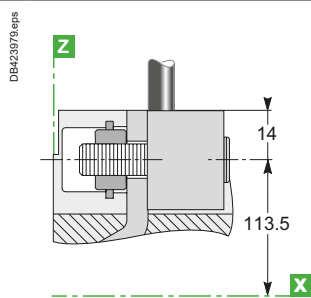

DB423975.eps

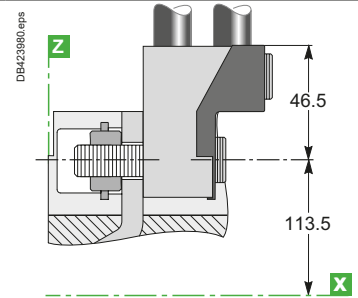

DB423800.eps

Distribution Connectors (for NSX100 to 250 Only)

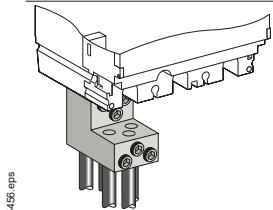

DB115456.eps

[a] VigiPacT add-on or NSX250

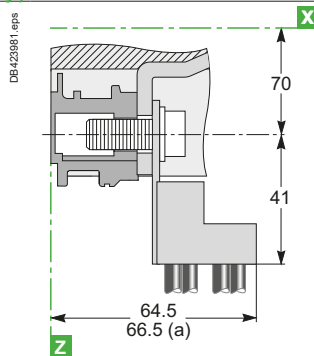

DB423801.eps

Right-Angle Terminal Extensions (Upstream Only) NSX100 to 250

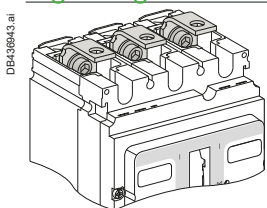

DB438943.ai

[b] NSX250

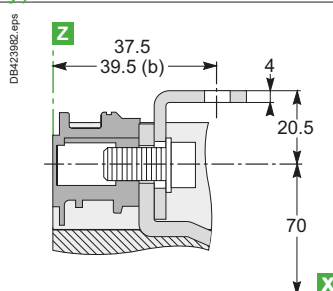

DB423905.eps

NSX400/630

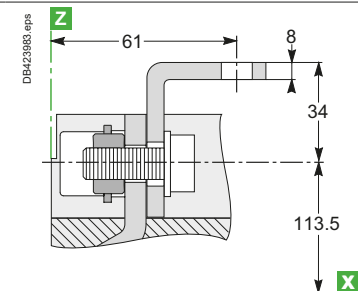

DB423893.eps

ComPacT NSX Power Connections

ComPacT NSX100 to 630 with/without VigiPacT Add-on Fixed Version

Connection with Accessories

Straight Terminal Extensions (for NSX100 to 250 Only)

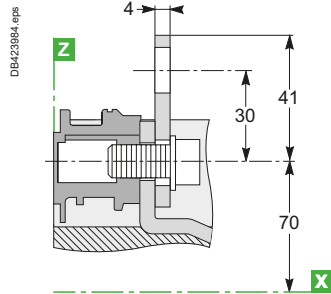
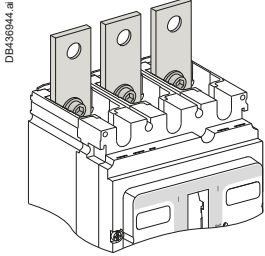

Edgewise Terminal Extensions

NSX100 to 250

NSX400/630

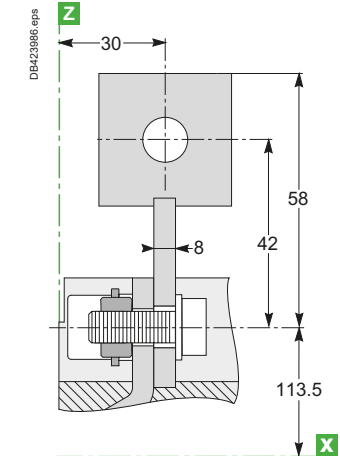
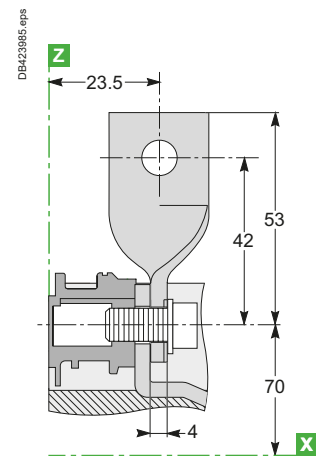
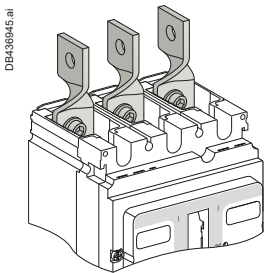

E

45° Terminal Extensions

NSX100 to 250

NSX400/630

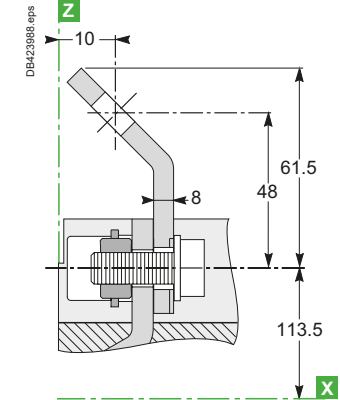
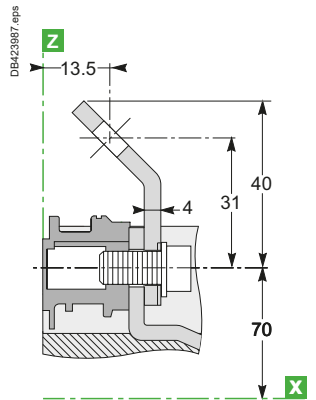
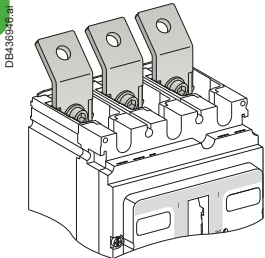

Double-L Terminal Extensions

NSX100 to 250

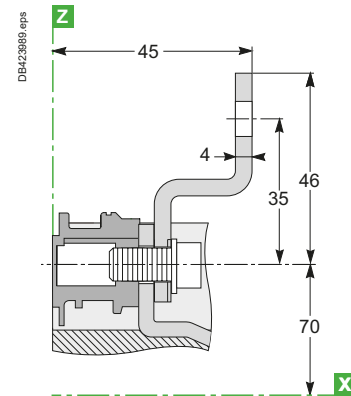
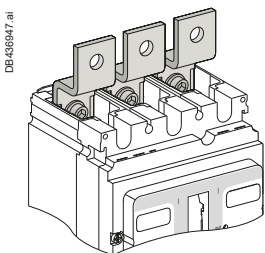

ComPacT NSX Power Connections

ComPacT NSX100 to 630 with/without VigiPacT Add-on Fixed Version

Connection with Accessories

Spreaders

3P

4P

NSX100 to 250

NSX400/630

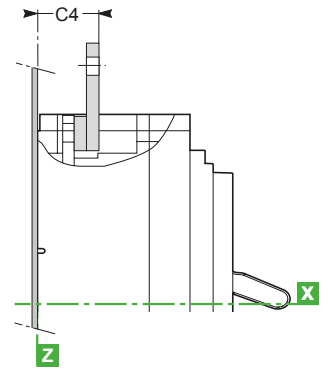
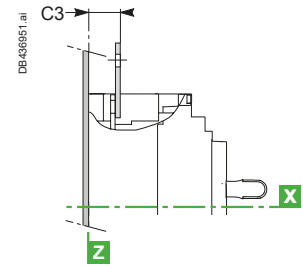
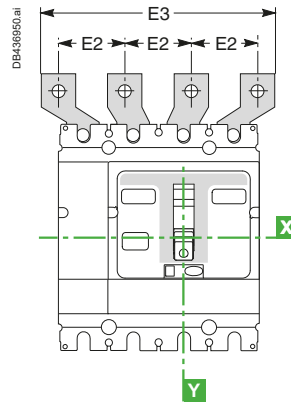
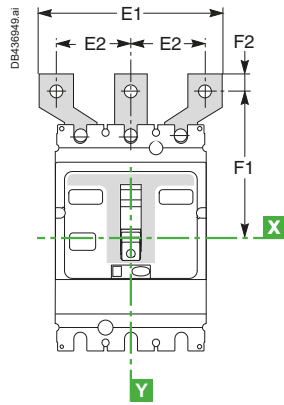
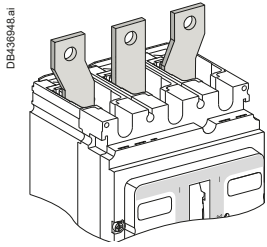

Type	C3	C4	E1	E2	E3	F1	F2
NSX100/160	23.5	-	114	45	159	100	11
NSX250	25.5	-	114	45	159	100	11
NSX400/630	-	44	135 170	52.5 70	187.5 240	152.5 166	15 15

One-Piece Spreader (for NSX100 to 250 Only)

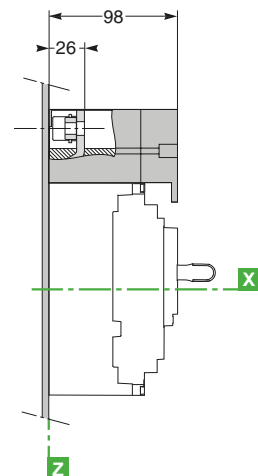
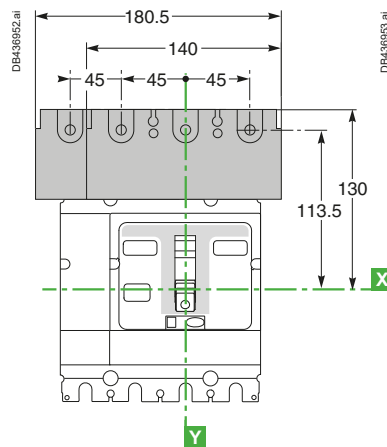
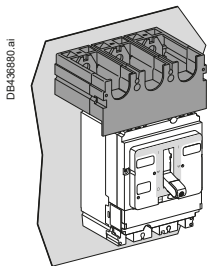

ComPacT NSX Power Connections

ComPacT NSX100 to 630 with/without VigiPacT Add-on Plug-in and Withdrawable Versions

Connection Locations

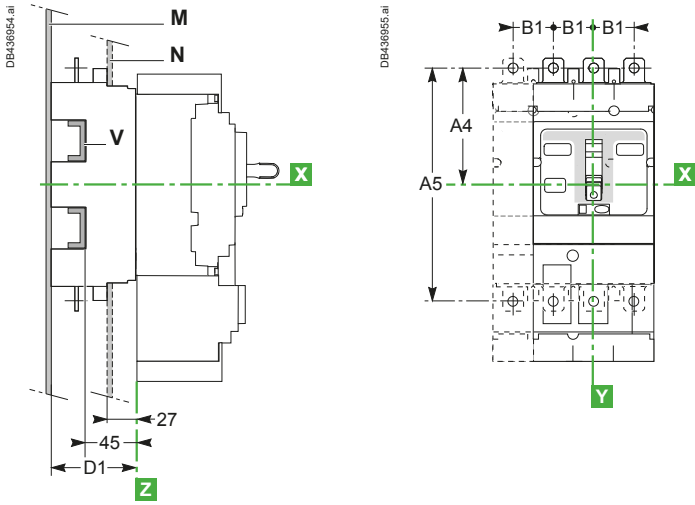

Type	A4	A5	B1	D1
NSX100 to 250	100	200	35	75
NSX400/630	156.5	313	45	100

Note:

- For mounting on a backplate, the insulating screen supplied with the plug-in base must be installed.
- For withdrawable versions, terminal shields are recommended.

Connection without Accessories

Front Connection: Mounting on Backplate (M) or Rails (V)

NSX100 to 250

NSX400/630

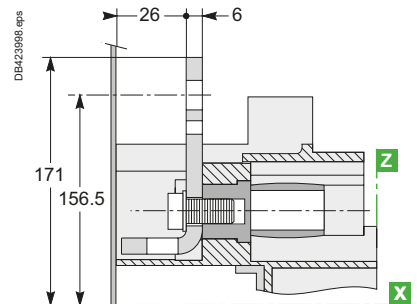
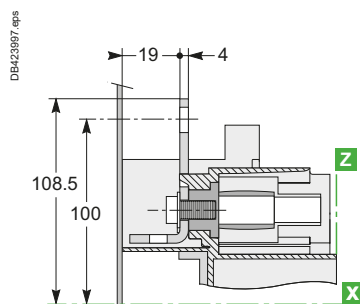
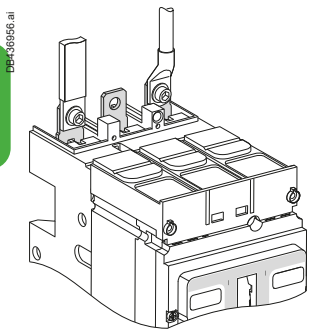

Rear Connection: Mounting Through Front Panel (N) or on Rails (V)

NSX100 to 250

NSX400/630

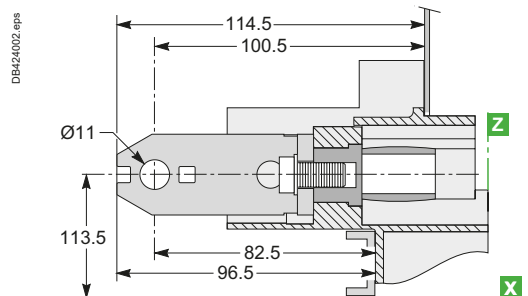
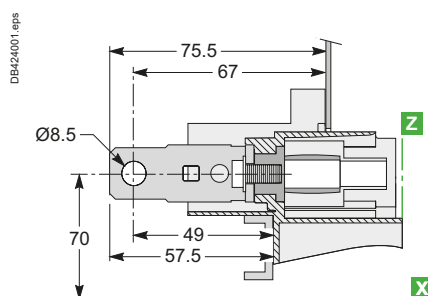
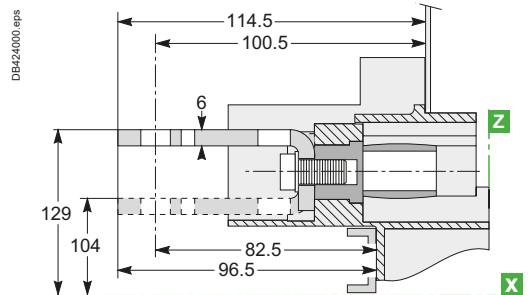
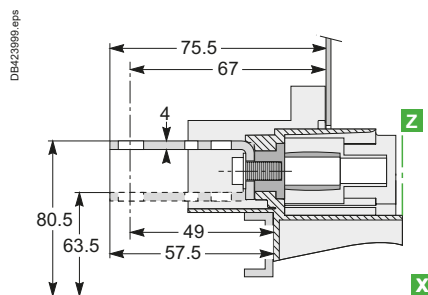
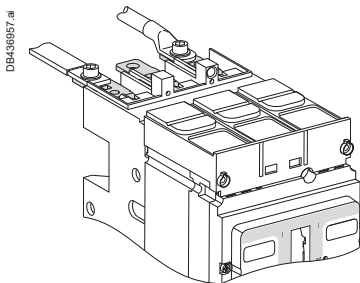

ComPacT NSX Power Connections

ComPacT NSX100 to 630 with/without VigiPacT Add-on Plug-in and Withdrawable Versions

Connection with Accessories

Bare-Cable Connectors: Mounting on Backplate (M) or Rails (V)

NSX100 to 250

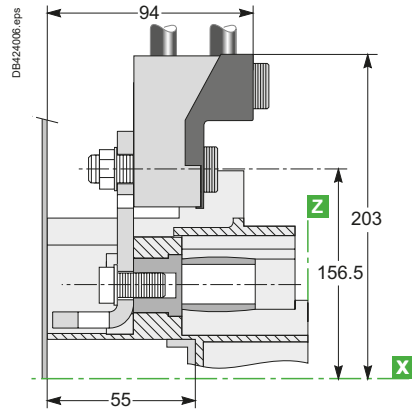
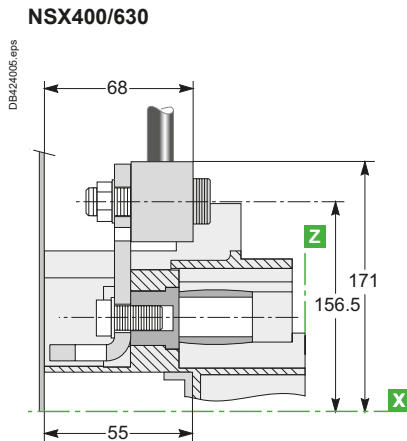
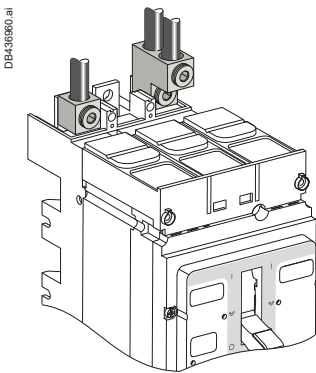
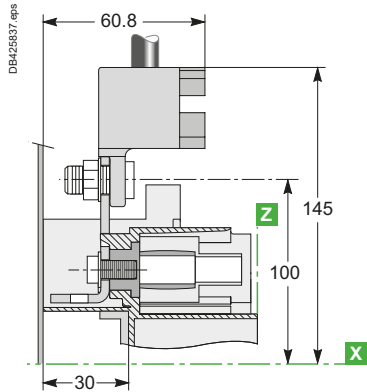
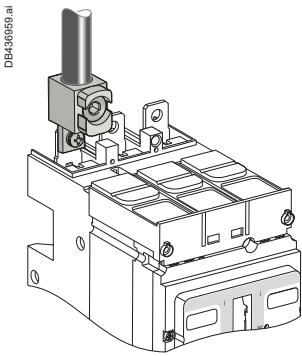
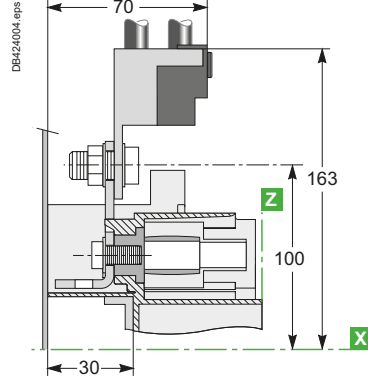
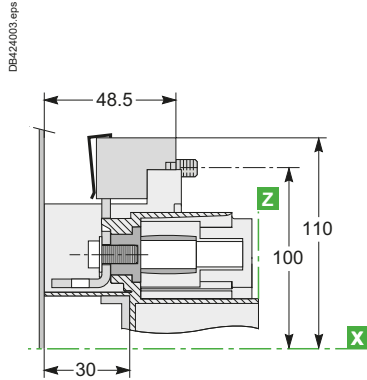
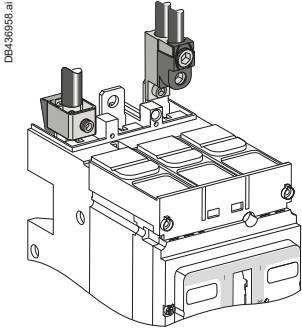

Bare-Cable Connectors: Mounting Through Front Panel (N) or on Rails (V)

NSX100 to 250

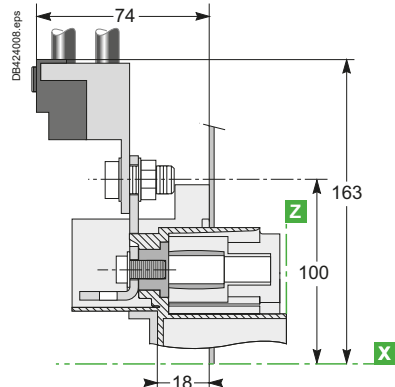
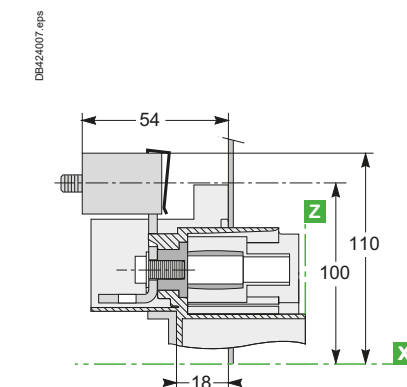
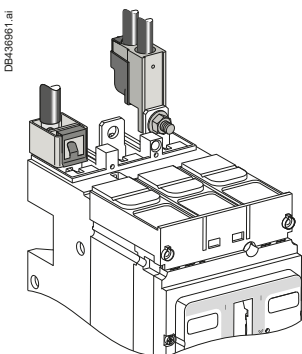

ComPacT NSX Power Connections

ComPacT NSX100 to 630 with/without VigiPacT Add-on Plug-in and Withdrawable Versions

Bare-Cable Connectors: Mounting Through Front Panel (N) or on Rails (V)

NSX400/630

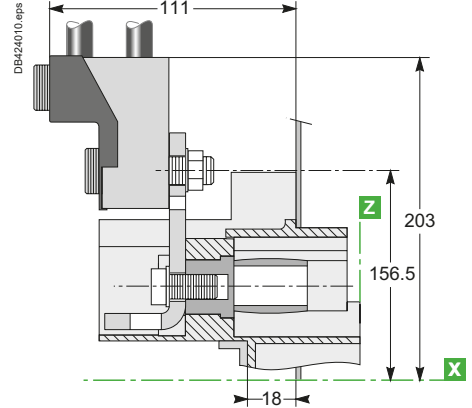
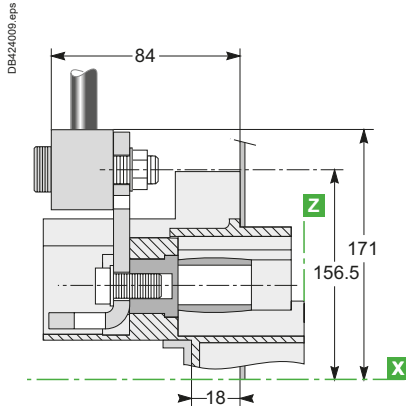
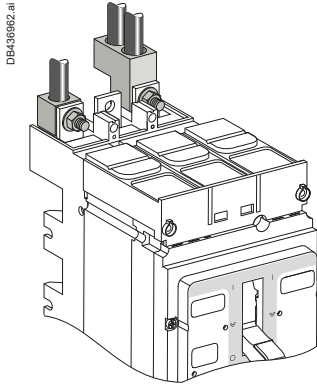

Connection with Accessories

45° Extensions: Mounting Through Front Panel (N) or on Rails (V)

NSX100 to 250

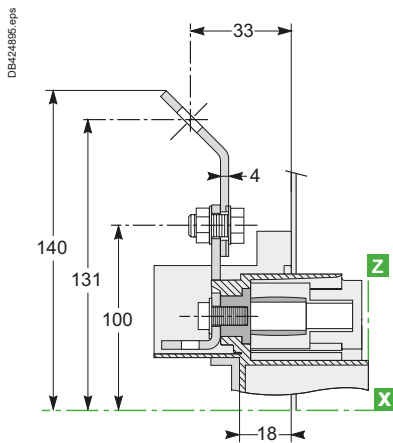
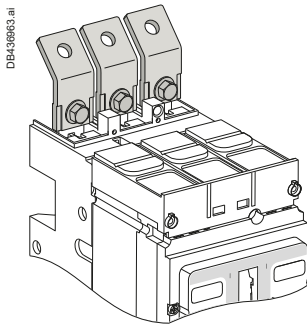

NSX400/630

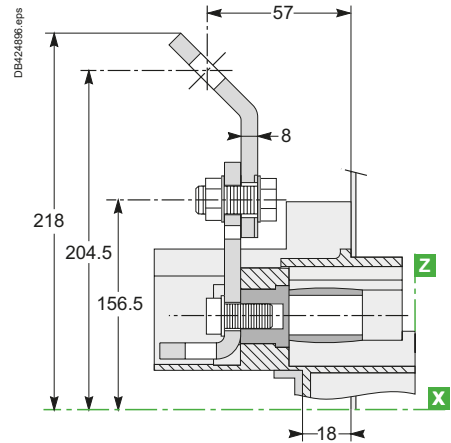

Double-L Extensions: Mounting on Backplate (M) or Rails (V)

NSX100 to 250

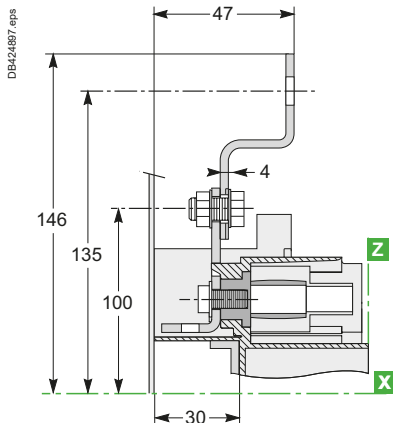
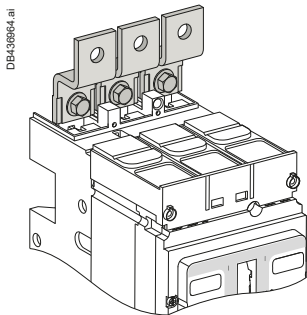

NSX100 to 250

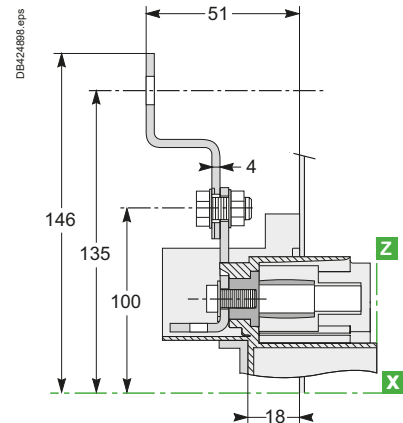

E

ComPacT NSX Power Connections

ComPacT NSX100 to 630 with/without VigiPacT Add-on Plug-in and Withdrawable Versions

Connection with Accessories

Spreaders: Mounting on Backplate (M) or Rails (V)

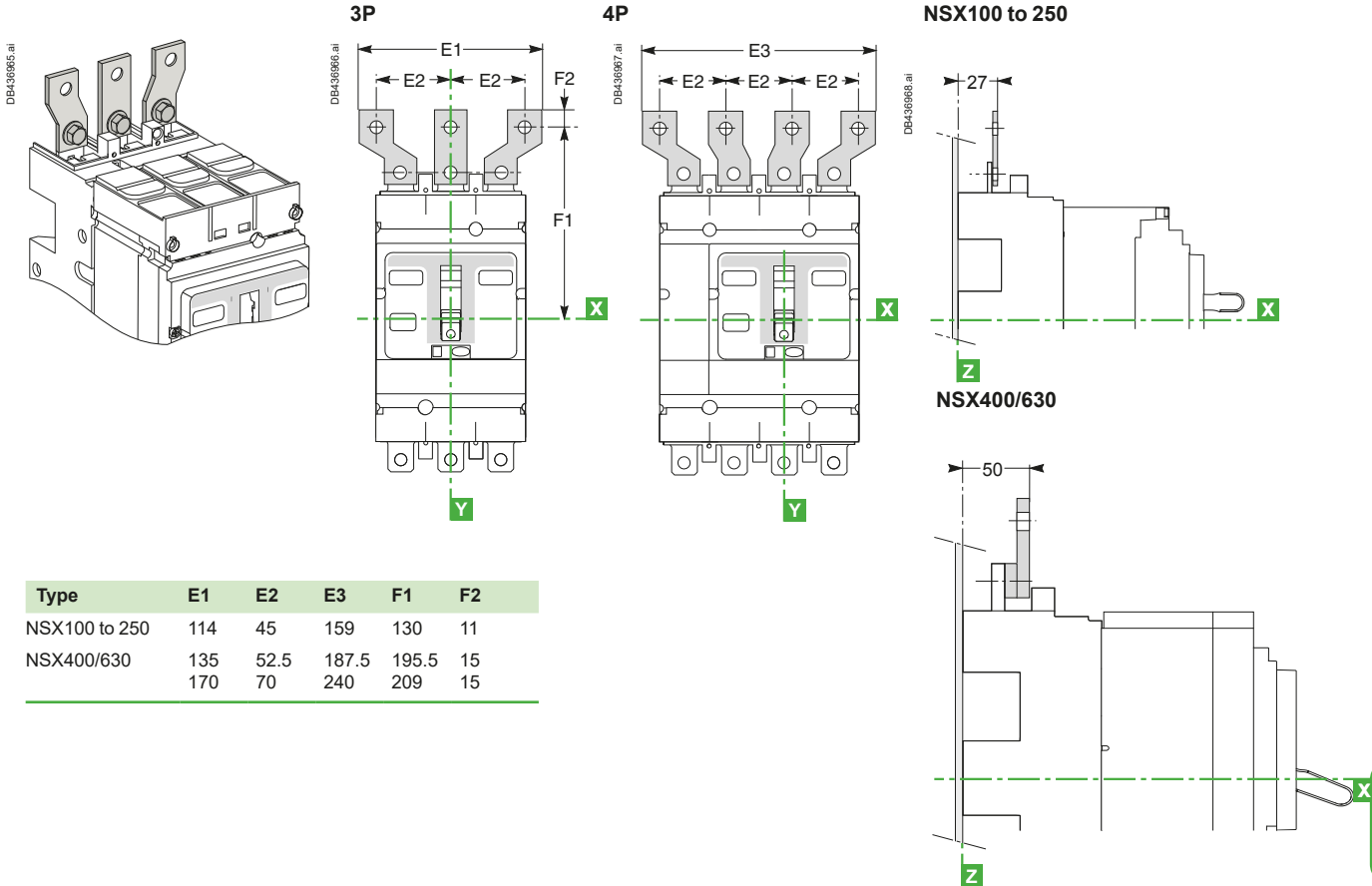

Long Insulated Rear Connectors: Mounting on Backplate (M) or Rails (V)

Exterior-mounted rear connectors NSX100 to 250

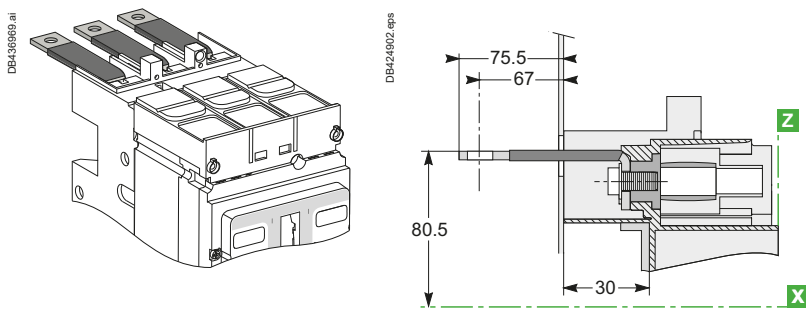

NSX400/630

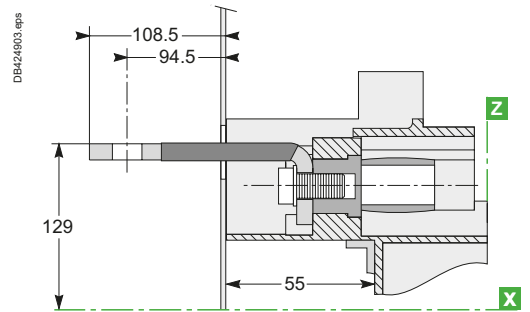

Interior-mounted rear connectors NSX100 to 250

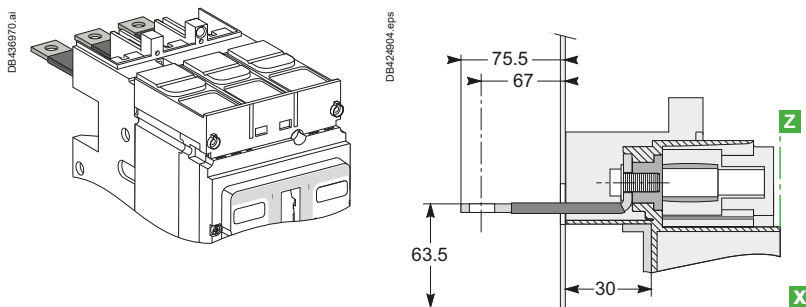

NSX400/630

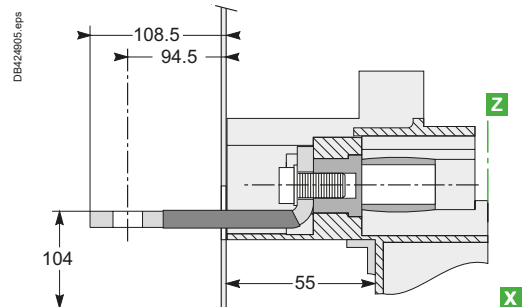

Long, insulated connectors are mandatory.

ComPacT NSX Power Connections

Connection of Insulated Bars or Cables with Lugs to ComPacT NSX100 to 630 with/without VigiPacT Add-on

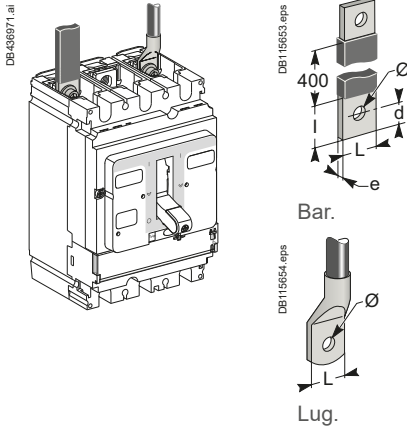

Direct Connection for NSX100 to 630

Dimensions		NSX100	NSX160/250	NSX400/630
Bars	L (mm)	≤ 25	≤ 25	≤ 32
	l (mm)	d + 10	d + 10	d + 15
	d (mm)	≤ 10	≤ 10	≤ 15
	e (mm)	≤ 6	≤ 6	3 ≤ e ≤ 10
	Ø (mm)	6.5	8.5	10.5
Lugs	L (mm)	≤ 25	≤ 25	≤ 32
	Ø (mm)	6.5	8.5	10.5
Torque (Nm) [1]		10	15	50
Torque (Nm) [2]		5/5	5/5	20/11
Torque (Nm) [3]		8	8	20

[1] Tightening torque on the circuit breaker for lugs or bars.

[2] Tightening torque on fixed devices for rear connectors/tightening torque on plug-in or withdrawable devices for power connectors.

[3] Tightening torque on the plug-in base for terminal extensions.

Accessories for NSX100 to 250

Straight terminal extensions

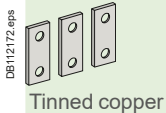

Double-L terminal extensions

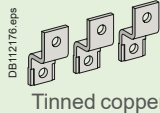

Spreaders: separate parts

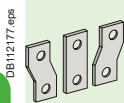

one-piece spreader

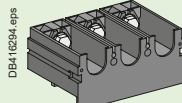

Tinned copper

For U > 600 V, the mandatory insulation kit is not compatible with spreaders made up of separate parts. The one-piece spreader must be used.

Connection with Accessories for NSX100 to 250 (60228)

Pole pitch

Without spreaders	35 mm
With spreaders	45 mm

Dimensions		With spreaders or terminal extensions	
		NSX100	NSX160/250

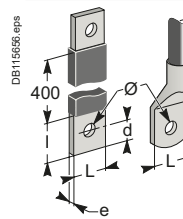

Bars	L (mm)	≤ 25	≤ 25
	l (mm)	20 ≤ l ≤ 25	20 ≤ l ≤ 25
	d (mm)	≤ 10	≤ 10
	e (mm)	≤ 6	≤ 6
	Ø (mm)	6.5	8.5
Lugs	L (mm)	≤ 25	≤ 25
	Ø (mm)	6.5	8.5
Torque (Nm) [1]		10	15
Torque (Nm) [2]		5	5

[1] Tightening torque on the circuit breaker for spreaders or terminal extensions.

[2] Tightening torque on the plug-in base for spreaders or terminal extensions.

Spreaders and straight, right-angle, 45°, double-L and edgewise terminal extensions are supplied with flexible interphase barriers.

Accessories for NSX400 and 630

Spreaders made up of separate parts for 52.5 and 70 mm pitch

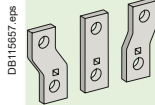

Tinned copper

For U > 600 V, use of the 52.5 mm pitch spreaders requires a specific insulation kit. The 70 mm pitch spreaders may not be used.

Connection with Accessories for NSX400 and 630 (60228)

Pole pitch

Without spreaders	45 mm
With spreaders	52.5 or 70 mm

Dimensions		With spreaders	With terminal extensions
------------	--	----------------	--------------------------

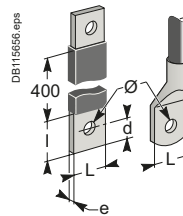

Bars	L (mm)	≤ 40	≤ 32
	l (mm)	d + 15	30 ≤ l ≤ 34
	d (mm)	≤ 20	≤ 15
	e (mm)	3 ≤ e ≤ 10	3 ≤ e ≤ 10
	Ø (mm)	12.5	10.5
Lugs	L (mm)	≤ 40	≤ 32
	Ø (mm)	12.5	10.5
Torque (Nm) [1]		50	50
Torque (Nm) [2]		20	20

[1] Tightening torque on the circuit breaker for spreaders or terminal extensions.

[2] Tightening torque on the plug-in base for spreaders or terminal extensions.

Spreaders and right-angle, 45° and edgewise terminal extensions are supplied with flexible interphase barriers.

Accessories for NSX100 to 630

Right-angle terminal extensions

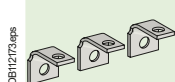

Tinned copper
To be mounted on upstream side.

Edgewise terminal extensions



Tinned copper

45° terminal extensions



Tinned copper

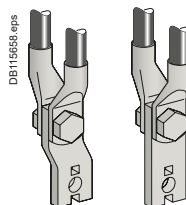

Mounting detail: 2 cables with lugs.

ComPacT NSX Power Connections

Connection of Bare Cables to ComPacT NSX100 to 630 with/without VigiPacT Add-on

Connection for NSX100 to 250

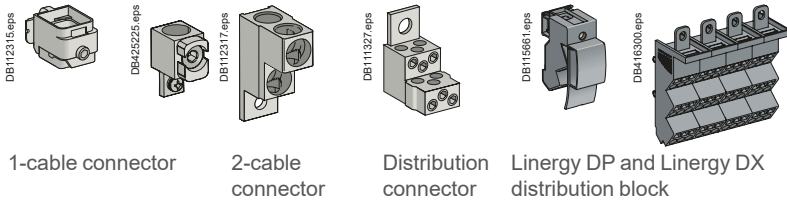

1-cable connector 2-cable connector Distribution connector Linergy DP and Linergy DX distribution block

	1-cable connector	Steel ≤ 160 A	Aluminium ≤ 250 A		
	L (mm)	25	25		
	S (mm ²) Cu/Al	1.5 to 95 ^[1]	25 to 50	70 to 95	120 to 240 150 max. flex.
	Torque (Nm)	12	20	26	31
	2-cable connector				
	L (mm)	25 or 50			
	S (mm ²) Cu/Al	2 x 50 to 2 x 120			
	Torque (Nm)	22			
	6-cable distribution connector (copper or aluminium)				
	L (mm)	15 or 30			
	S (mm ²) Cu/Al	1.5 to 6 ^[1]	8 to 35		
	Torque (Nm)	4	6		
	Linergy DX and Linergy DP distribution block (6 or 9 cables)				
	L (mm)	12	16		
	S (mm ²) Cu/Al	6 x 4 to 10	3 x 6 to 16		

[1] For flexible cables from 1.5 to 4 mm², connection with crimped or self-crimping ferrules.

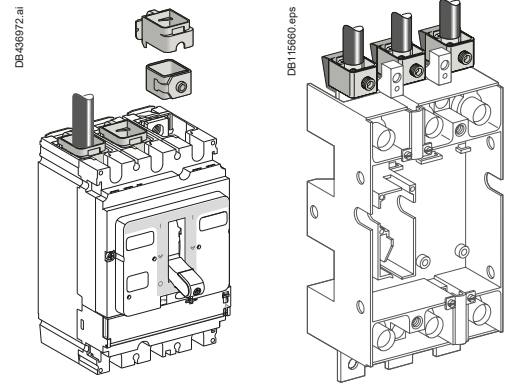

Connection for NSX400 and 630

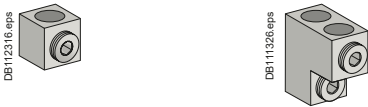

1-cable connector 2-cable connector

	1-cable connector	2-cable connector
	L (mm)	30
	S (mm ²) Cu/Al	35 to 300 rigid 240 max. flex.
	Torque (Nm)	31

Conductor Materials and Electrodynamical Stresses

ComPacT NSX circuit breakers can be connected indifferently with bare-copper, tinned-copper and tinned-aluminium conductors (flexible or rigid bars, cables). In the event of a short-circuit, thermal and electrodynamic stresses will be exerted on the conductors. They must therefore be correctly sized and held in place by supports.

Electrical connection points on switchgear devices (switch-disconnectors, contactors, circuit breakers, etc.) should not be used for mechanical support. Any partition between upstream and downstream connections of the device must be made of non-magnetic material.



The diagram is shown with circuits de-energized, relays in normal position, and all devices open, connected, and charged. Terminal connections shown as **O** must be connected by the customer.

Indication Contacts

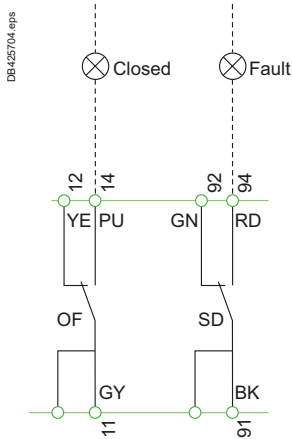

Indication Contacts

- OF** Device ON/OFF indication contacts
- SD** Trip indication contact

Color Code for Auxiliary Wiring

- BK:** Black
- GN:** Green
- GY:** Grey
- RD:** Red
- PU:** Purple
- YE:** Yellow

Remote Operation

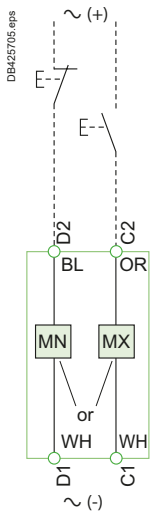

Remote Operation

- MN** Undervoltage Release
- or
- MX** Shunt trip Release

Color Code for Auxiliary Wiring

- BL:** Blue
- OR:** Orange
- WH:** White

E

Switchboard Integration ComPacT NSXm SDx Module for MicroLogic Vigi 4.1 (ELCB)

The diagram is shown with circuits de-energized, all devices open, connected and charged and relays in normal position.

Connection

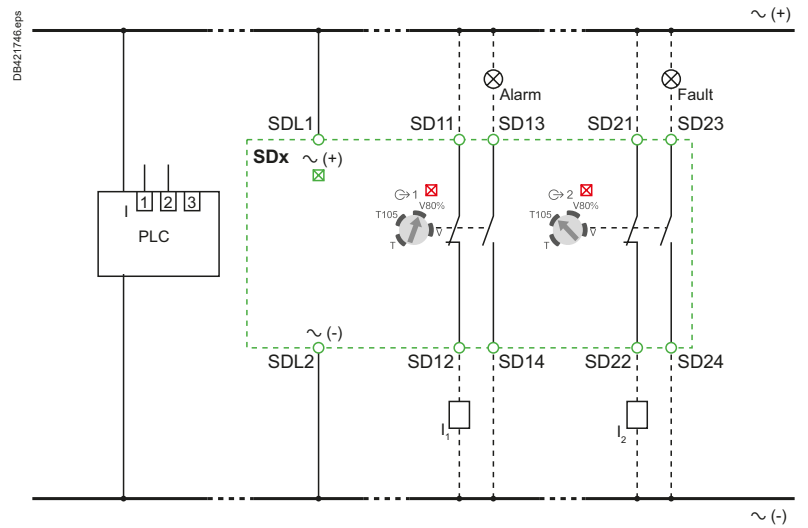

Operation

- I: charge current
- SDT105: overload alarm
- SDT: overload trip indication
- $I_{\Delta n}$: earth leakage current
- SDV80: earth leakage alarm
- SDV: earth leakage trip indication
- Q: circuit breaker

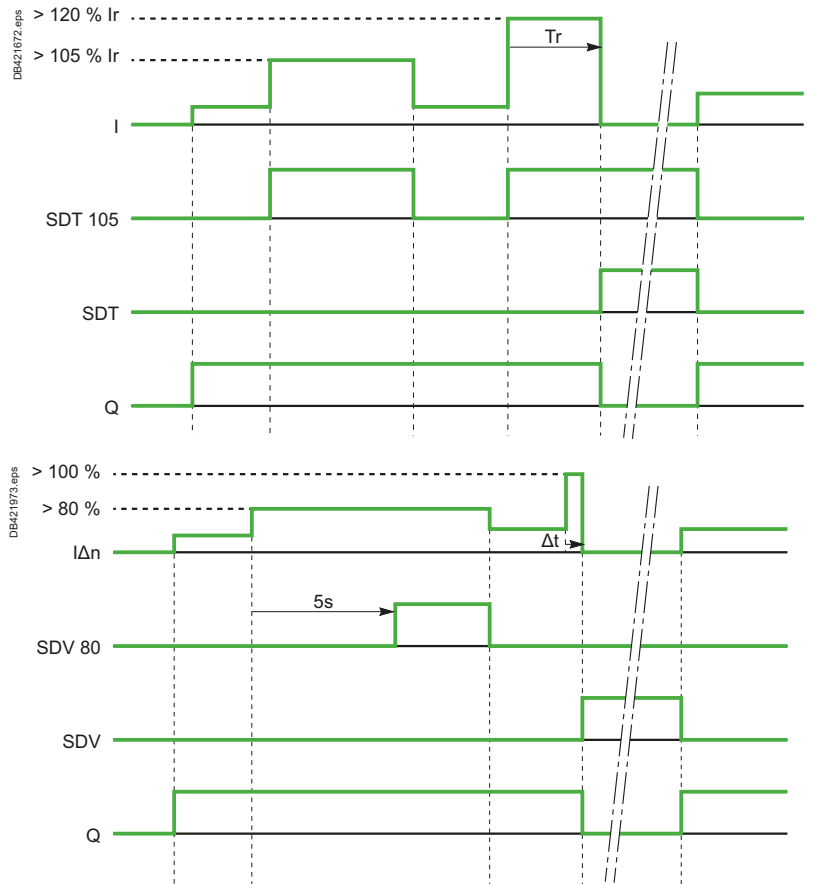

Power

MicroLogic

Remote Operation

DB425443.eps

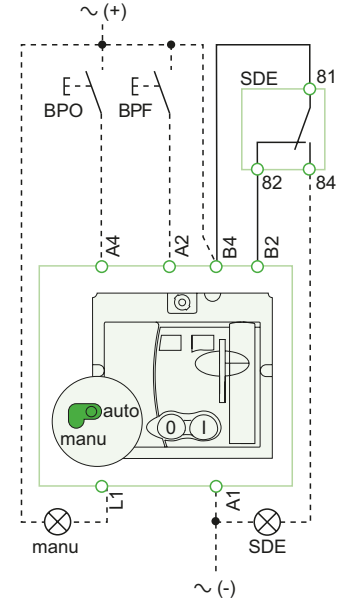
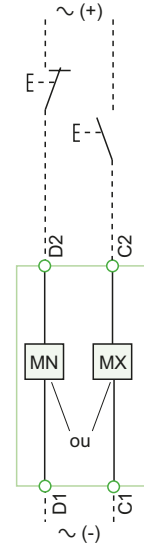
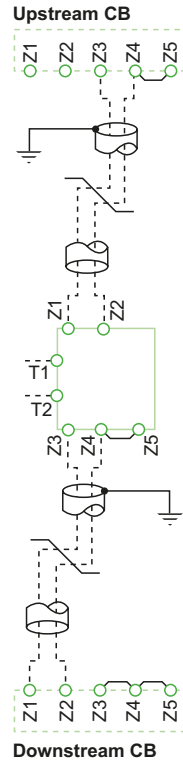
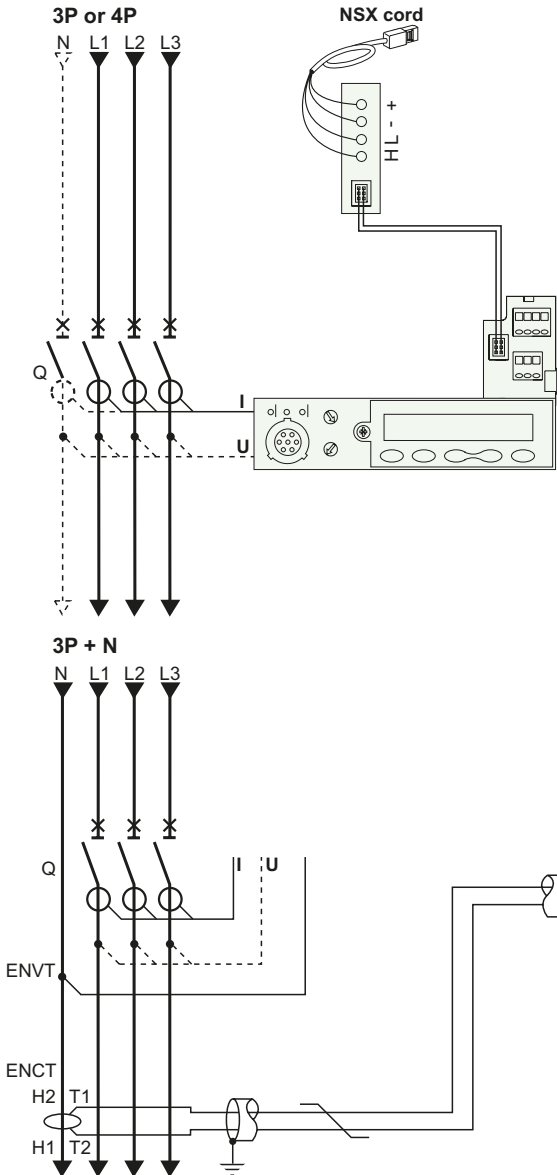

Motor mechanism (MT)

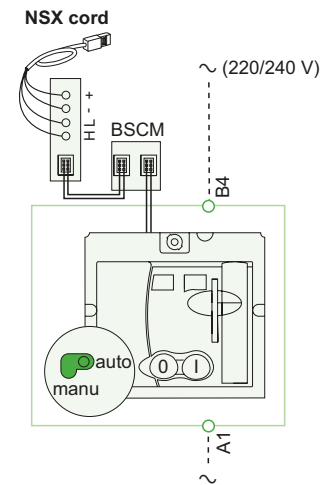

Communicating motor mechanism (MTC)

MicroLogic E

Communication
 H(WH), L(BL): data
 - (BK), + (RD): 24 V DC power supply

ZSI (Zone Selective Interlocking)
 Z1: ZSI OUT SOURCE
 Z2: ZSI OUT
 Z3: ZSI IN SOURCE
 Z4: ZSI IN ST (short time)
 Z5: ZSI IN GF (ground fault)
Note: Z3, Z4, Z5 for NSX400/630 only.

ENCT: external neutral current transformer:
 - shielded cable with 1 twisted pair (T1, T2)
 - shielding earthed at one end only (CT end).
 Connection L = 30 cm max.
 - maximum length of 10 metres
 - cable size 0.4 to 1.5 mm²
 - recommended cable: Belden 8441 or equivalent.

ENVT: external neutral voltage tap for connection to the neutral via a 3P circuit breaker.

Remote operation

MN: undervoltage release
or
MX: shunt release

Motor mechanism (MT)

A4: opening order
A2: closing order
B4, A1: power supply to motor mechanism
L1: manual position (manu)
B2: SDE interlocking (mandatory for correct operation)

BPO: opening pushbutton
BPF: closing pushbutton

Communicating motor mechanism (MTC)

B4, A1: motor mechanism power supply
BSCM: breaker status and control module



ComPacT NSX Fixed Circuit Breakers

Indication Contacts

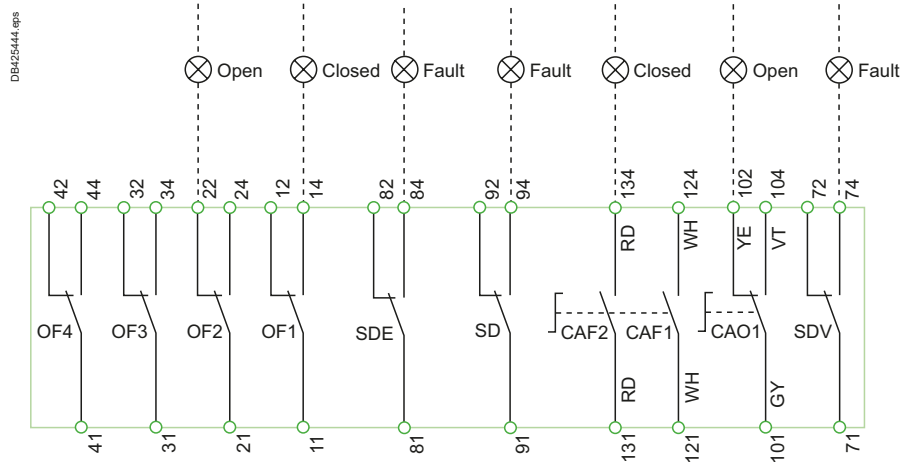

The diagram is shown with circuits de-energized, all devices open, connected and charged and relays in normal position. Terminals shown in green **O** must be connected by the customer.

Indication Contacts

- OF2/OF1:** device ON/OFF indication contacts
- OF4/OF3:** device ON/OFF indication contacts (NSX400/630)
- SDE:** fault-trip indication contact (short-circuit, overload, ground fault, earth leakage)
- SD:** trip-indication contact
- CAF2/CAF1:** early-make contact (rotary handle only)
- CAO1:** early-break contact (rotary handle only)
- SDV:** earth leakage fault trip indication contact (VigiPacT add-on)

Color Code for Auxiliary Wiring

- | | |
|-------------------|-------------------|
| RD: red | VT: violet |
| WH: white | GY: grey |
| YE: yellow | OR: orange |
| BK: black | BL: blue |
| GN: green | |

ComPacT NSX Plug-in/Withdrawable Circuit Breakers

Power

MicroLogic

Remote Operation

DB 425445 eps

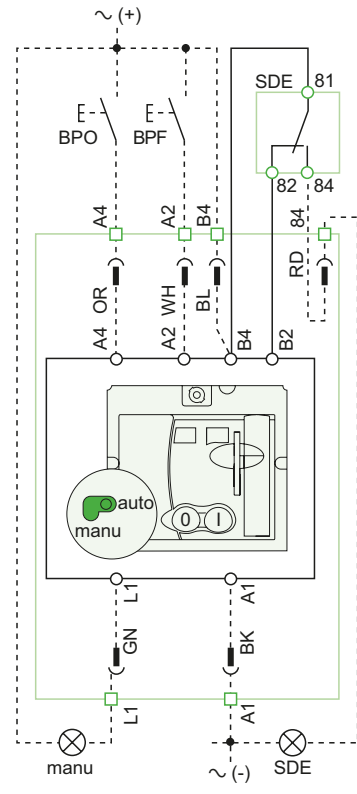
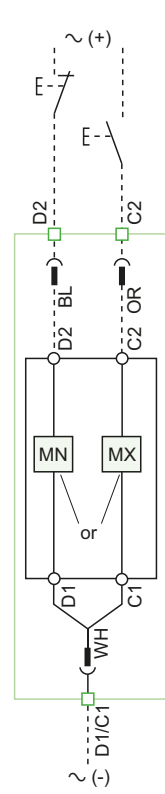
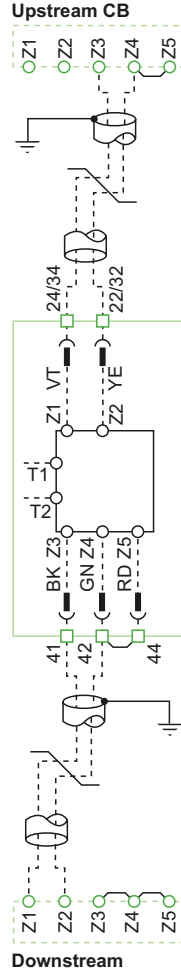
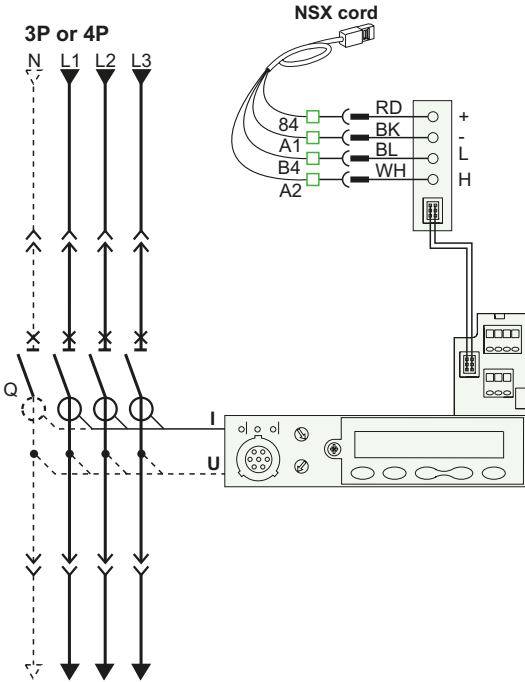

Motor mechanism (MT)

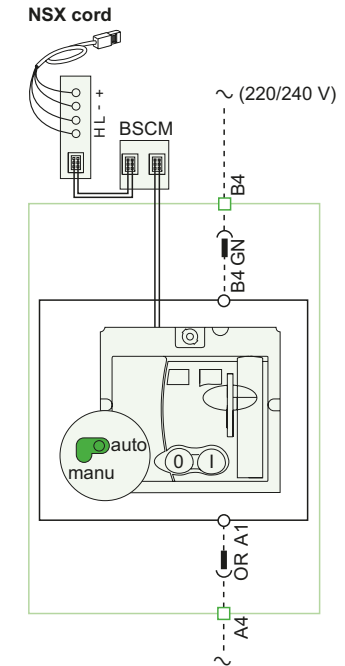

Communicating motor mechanism (MTC)

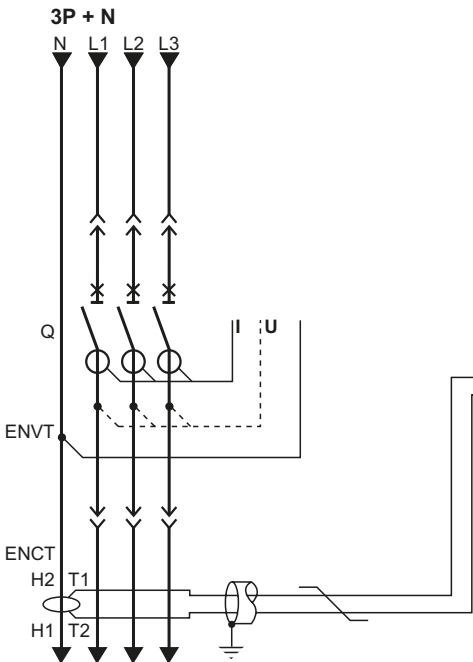

The diagram is shown with circuits de-energized, all devices open, connected and charged and relays in normal position.



ComPacT NSX

Plug-in/Withdrawable Circuit Breakers

Indication Contacts

Carriage Switches

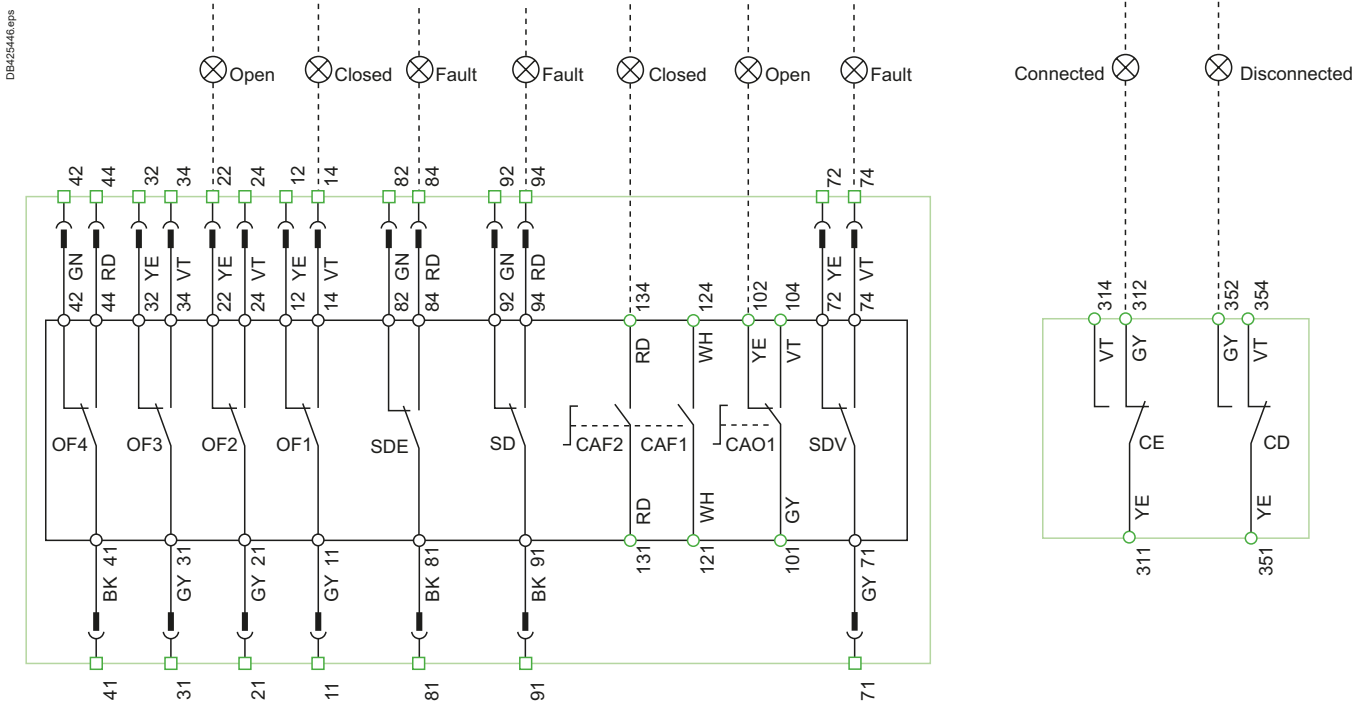

E

MicroLogic E

Communication

H(WH), L(BL): data
 - (BK), + (RD): 24 V DC power supply

ZSI (Zone Selective Interlocking)

Z1: ZSI OUT SOURCE

Z2: ZSI OUT

Z3: ZSI IN SOURCE

Z4: ZSI IN ST (short time)

Z5: ZSI IN GF (ground fault)

Note: Z3, Z4, Z5 for NSX400/630 only.

ENCT: external neutral current transformer:

- shielded cable with 1 twisted pair (T1, T2)
 - shielding earthed at one end only (CT end).

Connection L = 30 cm max.

- maximum length of 10 metres

- cable size 0.4 to 1.5 mm²

- recommended cable: Belden 8441 or equivalent.

ENV: external neutral voltage tap for connection to the neutral via a 3P circuit breaker.

Color code for auxiliary wiring

RD: red	VT: violet
WH: white	GY: grey
YE: yellow	OR: orange
BK: black	BL: blue
GN: green	

Terminals shown in green □/○ must be connected by the customer.

Remote operation

MN: undervoltage release

or

MX: shunt release

Motor mechanism (MT)

A4: opening order

A2: closing order

B4, A1: motor mechanism power supply

L1: manual position (manu)

B2: SDE interlocking (mandatory for automatic or remote recharging)

BPO: opening pushbutton

BPF: closing pushbutton

Communicating motor mechanism (MTc)

B4, A1: motor mechanism power supply

BSCM: breaker status and control module

Indication contacts

OF2/OF1: device ON/OFF indication contacts

OF4/OF3: device ON/OFF indication contacts (NSX400/630)

SDE: fault-trip indication contact

(short-circuit, overload, ground fault, earth leakage)

SD: trip-indication contact

CAF2/CAF1: early-make contact (rotary handle only)

CAO1: early-break contact (rotary handle only)

SDV: earth leakage fault trip indication contact (VigiPacT add-on)

The diagram is shown with circuits de-energized, all devices open, connected and charged and relays in normal position.

After tripping initiated by the "Push to trip" button or by the undervoltage (MN) release or the shunt (MX) release, device reset can be automatic, remote or manual.

Following tripping due to an electrical fault (with an SDE contact), reset must be carried out manually.

Motor mechanism (MT) with automatic reset

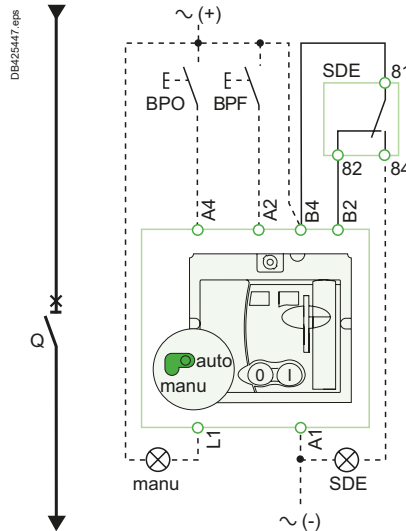

Motor mechanism (MT) with remote reset

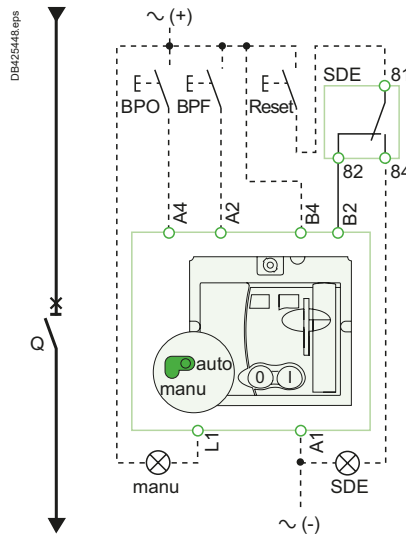

Motor mechanism (MT) with manual reset

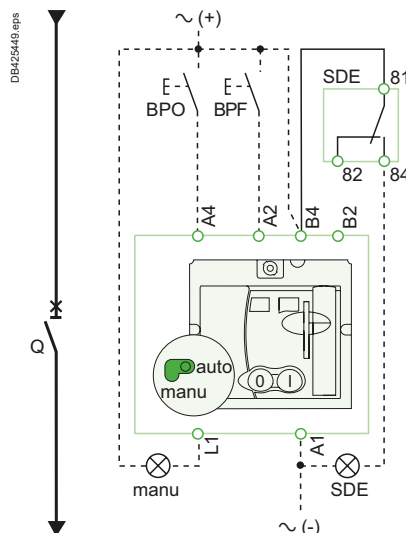

Symbols

- Q:** circuit breaker
- A4:** opening order
- A2:** closing order
- B4, A1:** motor mechanism power supply
- L1:** manual position (manu)
- B2:** SDE interlocking (mandatory for correct operation)
- BPO:** opening pushbutton
- BPF:** closing pushbutton
- SDE:** fault-trip indication contact (short-circuit, overload, ground fault, earth leakage)



ComPacT NSX Motor Mechanism

Communicating motor mechanism (MTC)

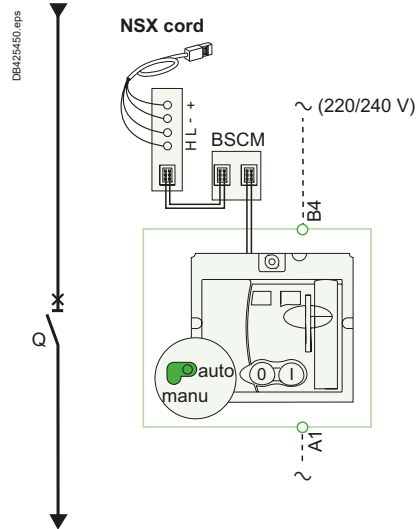

Schematic representation of the communicating motor mechanism (MT).

Single-line diagram of communicating motor mechanism

Opening, closing and reset orders are transmitted via the communication network. The "Enable automatic reset" and "Enable reset even if SDE" parameters must be set using the EcoStruxure Power Commission software via the screen by clicking the blue text.

"Auto/manu" is a switch on the front of the motor mechanism.

Symbols

- Q:** circuit breaker
- B4, A1:** motor mechanism power supply
- BSCM:** breaker status and control module

Terminals shown in green ○ must be connected by the customer.

Switchboard Integration ComPacT NSX SDx Module with MicroLogic

The diagram is shown with circuits de-energized, all devices open, connected and charged and relays in normal position.

Connection

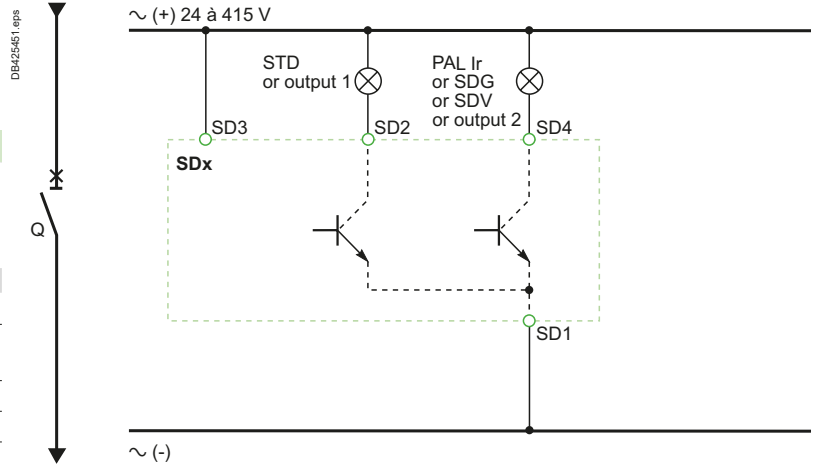

Symbols

- SD1, SD3:** SDx-module power supply
- SD2:** output 1 (80 mA max.)
- SD4:** output 2 (80 mA max.)

	SD2	SD4
MicroLogic 2	SDT	-
MicroLogic Vigi 4	SDT	SDV
MicroLogic 5	SDT or output 1	PAL Ir or output 2
MicroLogic 6	SDT or output 1	SDG or output 2
MicroLogic Vigi 7	SDT or output 1	SDV or output 2

Terminals shown in green **O** must be connected by the customer.

Operation

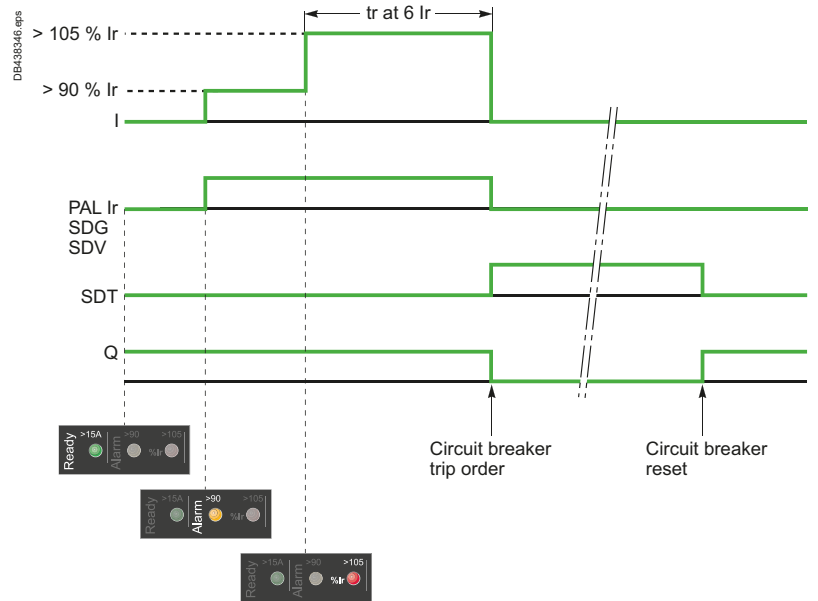

- I:** charge current
- PAL Ir:** thermal overload pre-alarm
- SDG:** ground-fault signal
- SDT:** thermal-fault signal
- SDV:** residual current trip signal
- Q:** circuit breaker



ComPacT NSX SDTAM Module with MicroLogic M

The diagram is shown with circuits de-energized, all devices open, connected and charged and relays in normal position.

Symbols

- SD1, SD3:** SDTAM-module power supply
- SD2:** thermal-fault signal output (80 mA max.)
- SD4:** contactor-control output (80 mA max.)

	SD2	SD4
MicroLogic 2-M	SDT	KA1
MicroLogic 6 E-M	SDT	KA1

Terminals shown in green ○ must be connected by the customer.

Connection

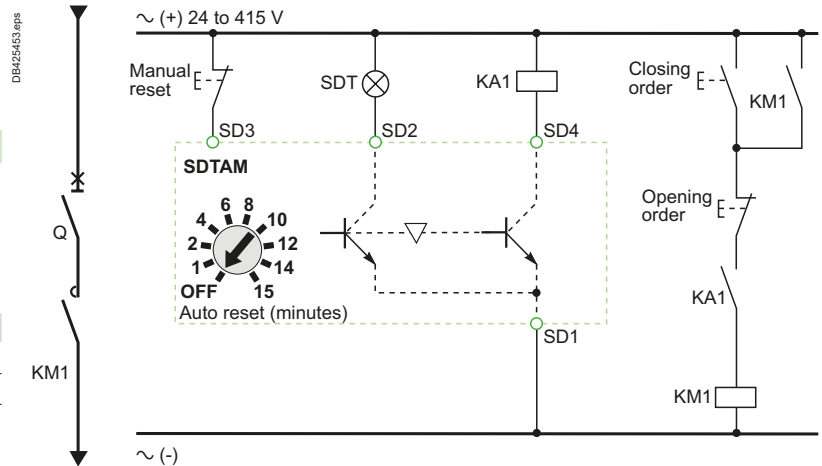

Operation

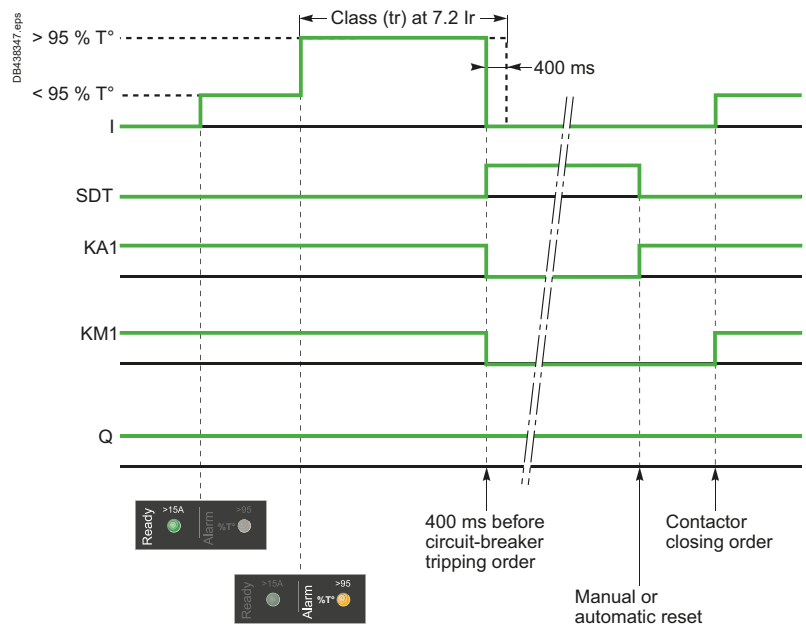

- I:** charge current
- SDT:** thermal-fault signal
- KA1:** auxiliary relay (e.g. RBN or RTBT relay)
- KM1:** motor contactor
- Q:** circuit breaker

Connection of Circuit Breakers to the Modbus Communication Network

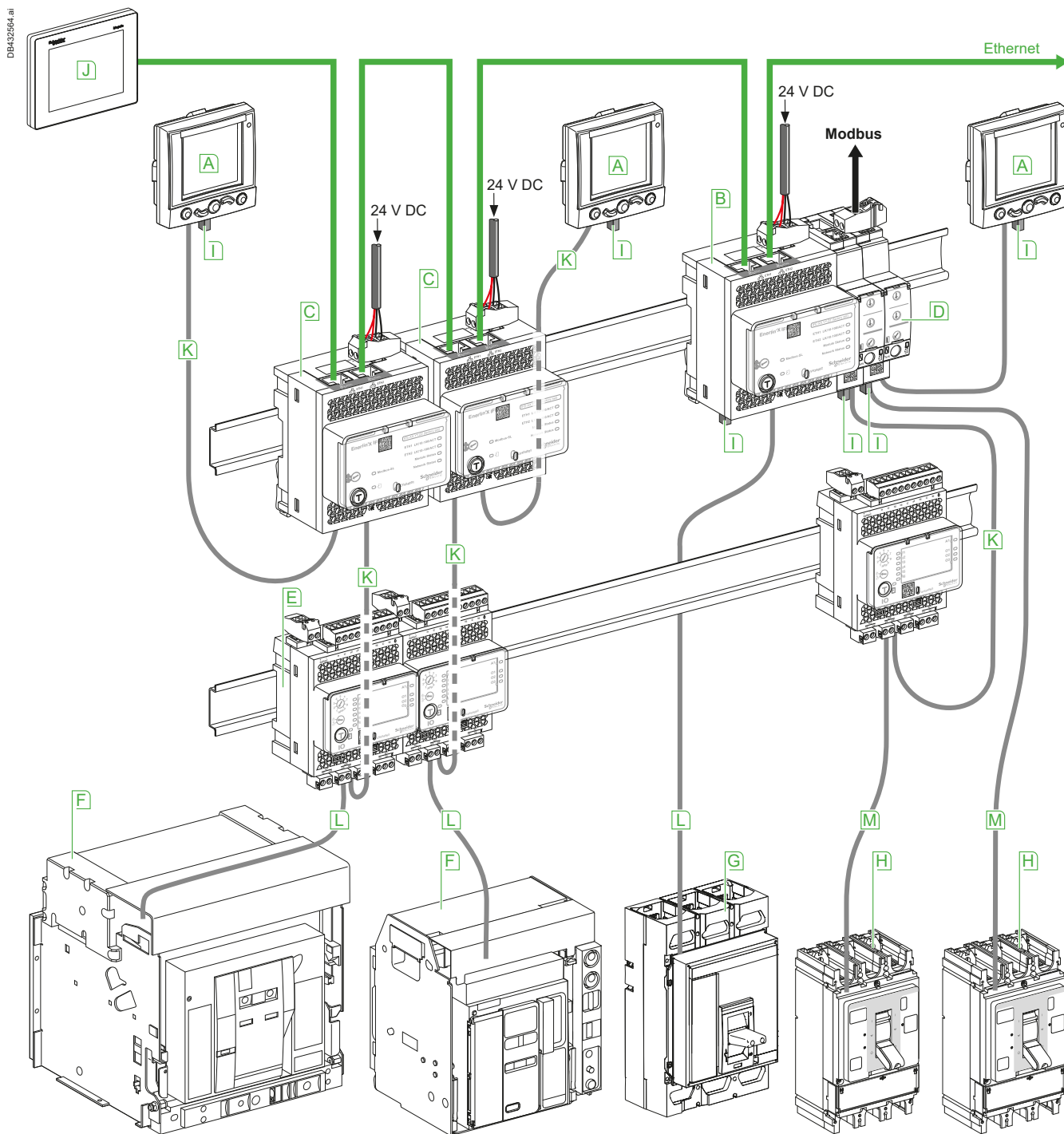

- A** FDM121 (TRV00121)
- B** IFE interface (LV434002)
- C** IFE switchboard server (LV434001)
- D** IFM (LV484000)
- E** I/O application module (LV434063)
- F** MasterPact MTZ
- G** ComPacT NS630b-3200
- H** ComPacT NSX
- I** ULP termination (TRV00880)
- J** FDM128 (LV434128)

- K** ULP cable
- L** Breaker ULP cord
- M** NSX cord
- Ethernet
- Modbus

Switchboard Integration

ComPacT NSX

Communication

DB450285.ai

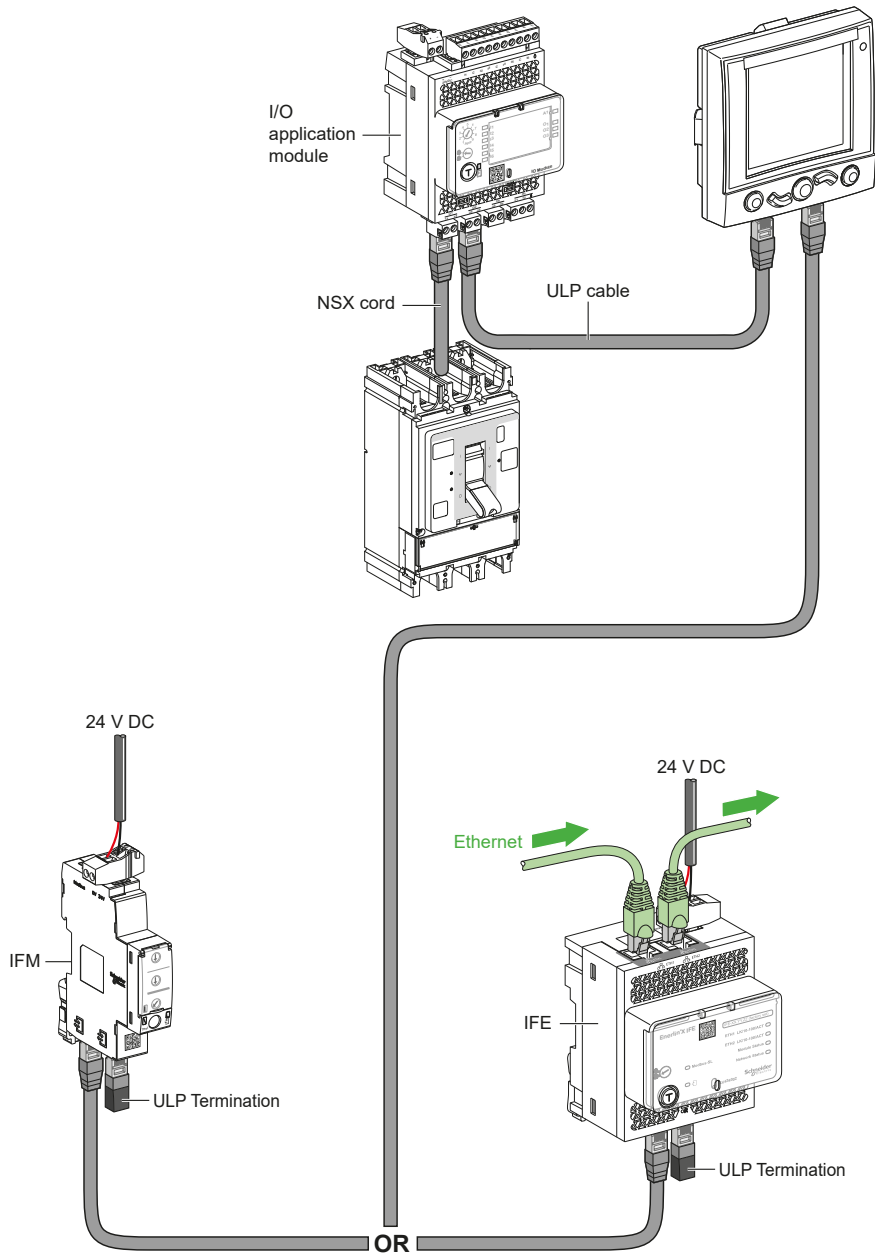

Order your ComPacT NSX and NSXm Through Digital Tools Product Selector

Go on the range page on www.se.com

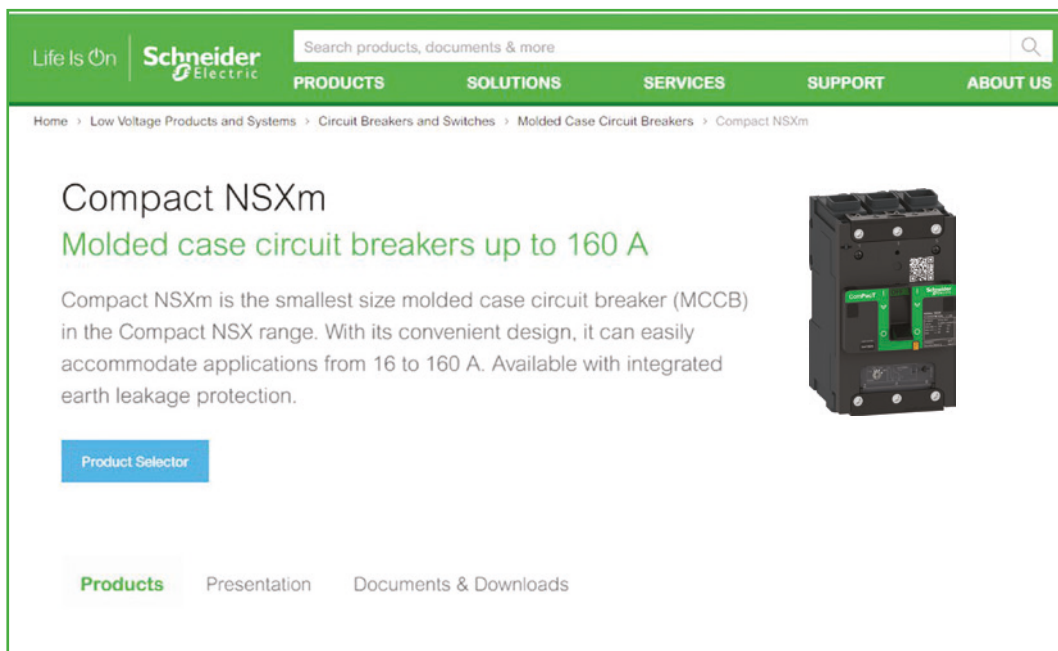

To select your ComPacT NSXm, use the product selector available at <https://www.se.com/ww/en/work/support/product-selector/>.



Type (1)	Frame Rating (2)	Breaking Capacity (1)	Num Poles (2)	Trip Unit (2)	Trip Unit Ratings (3)	Suffix (1)
NSX = C	100m = 11	16kA = E	1P = 1	TMD = TM	16 = 016	EverLink = L
NSXm = C	160m = 12	25kA = B	2P = 2	MA = MA	20 = 020	Busbar = B
	100 = 10	36kA = F	3P3D = 3	TMG = MG	25 = 025	Fixed = F
	160 = 16	50kA = N	4P4D = 4	1.3 M = 1M	30 = 030	DC = D
	250 = 25	70kA = H	3P2D = 5	2.2 = 2D	40 = 040	Switch = S
	400 = 40	100kA = S	4P3D = 6	2.3 = 2D	50 = 050	DC PV = DP
	630 = 63	150kA = L		4.1 = 4V	63 = 063	
		...		4.2 = 4V	80 = 080	Acc with ID
				...	100 = 100	change = T
					...	

Order your ComPacT NSX and NSXm Through Digital Tools Product Selector

Go on the range page on www.schneider-electric.com

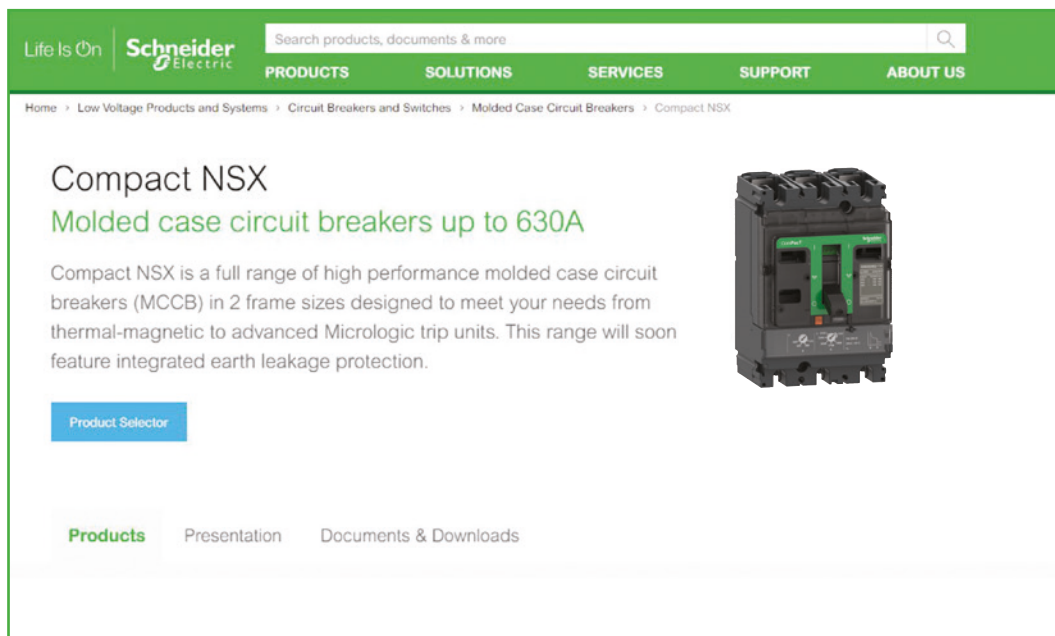

The screenshot displays the Schneider Electric website interface for the Compact NSX product line. At the top, there is a green navigation bar with the Schneider Electric logo and a search bar. Below the navigation bar, a breadcrumb trail reads: Home > Low Voltage Products and Systems > Circuit Breakers and Switches > Molded Case Circuit Breakers > Compact NSX. The main content area features the title "Compact NSX" and the subtitle "Molded case circuit breakers up to 630A". A descriptive paragraph states: "Compact NSX is a full range of high performance molded case circuit breakers (MCCB) in 2 frame sizes designed to meet your needs from thermal-magnetic to advanced Micrologic trip units. This range will soon feature integrated earth leakage protection." To the right of the text is an image of a compact NSX circuit breaker. Below the text is a blue button labeled "Product Selector". At the bottom of the page, there are links for "Products", "Presentation", and "Documents & Downloads".

To select your ComPacT NSX, use the product selector available at <https://www.se.com/ww/en/work/support/product-selector/>.

Catalog Numbers

ComPacT NSXm.....	F-3
ComPacT NSX100-250	F-15
ComPacT NSX400-630	F-49
Source-Changeover Systems for 2 Devices ComPacT NSX100 to NSX630.....	F-72
Order Form	F-74



Other Chapters

Select Circuit Breakers and Switch-Disconnectors	A-1
Select Protection	B-1
Customize Circuit Breakers with Accessories.....	C-1
Smart Panel Integration	D-1
Switchboard Integration.....	E-1
Glossary	G-1
Additional Characteristics.....	H-1

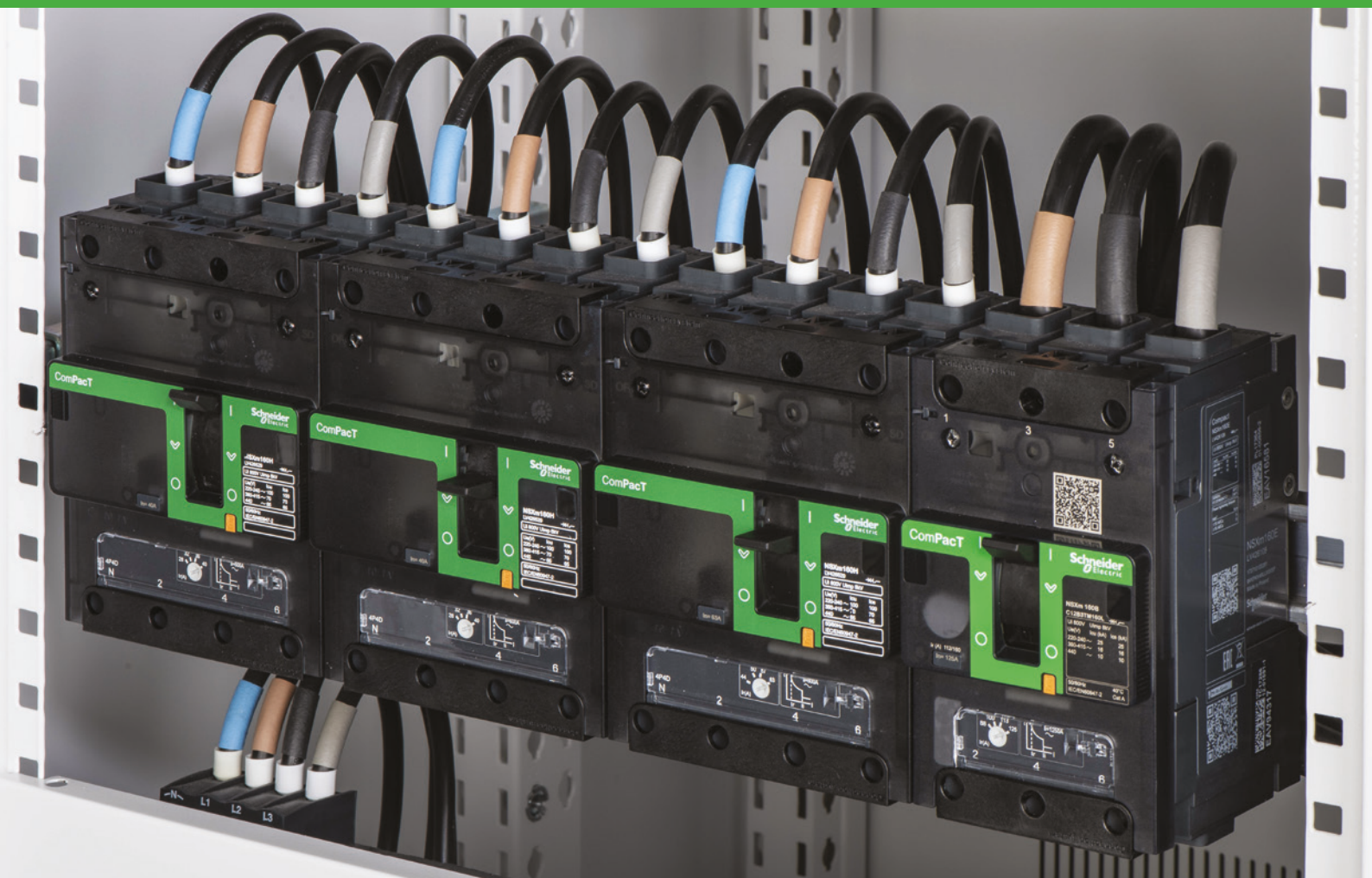

Catalog Numbers: ComPacT NSXm

Complete Fixed Device

ComPacT NSXm E/B (16/25 KA at 380/415 V).....	F-4
ComPacT NSXm F/N (36/50 KA at 380/415 V).....	F-5
ComPacT NSXm H (70 KA at 380/415 V).....	F-6
ComPacT NSXm MicroLogic Vigi 4.1 E/B/F (16/25/36 KA at 380/415 V).....	F-7
ComPacT NSXm MicroLogic Vigi 4.1 N/H (50/70 KA at 380/415 V).....	F-8
ComPacT NSXm NA.....	F-9

Accessories

Connection and Insulation.....	F-10
Electrical Auxiliaries.....	F-11
Rotary Handles, Locks and Seals.....	F-12
Spare Parts, Test Tool and Software.....	F-13

Other Chapters

Select Circuit Breakers and Switch-Disconnectors.....	A-1
Select Protection.....	B-1
Customize Circuit Breakers with Accessories.....	C-1
Smart Panel Integration.....	D-1
Switchboard Integration.....	E-1
Glossary.....	G-1
Additional Characteristics.....	H-1

Complete Fixed Device

ComPacT NSXm E/B (16/25 KA at 380/415 V)

ComPacT NSXm E (16 KA at 380/415 V)

With thermal-magnetic trip unit TM-D

DB438973.ai

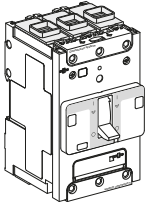

EverLink™ connectors

Rating	3P	4P 3d	4P 4d
TM16D	C11E3TM016L	C11E6TM016L	C11E4TM016L
TM25D	C11E3TM025L	C11E6TM025L	C11E4TM025L
TM32D	C11E3TM032L	C11E6TM032L	C11E4TM032L
TM40D	C11E3TM040L	C11E6TM040L	C11E4TM040L
TM50D	C11E3TM050L	C11E6TM050L	C11E4TM050L
TM63D	C11E3TM063L	C11E6TM063L	C11E4TM063L
TM80D	C11E3TM080L	C11E6TM080L	C11E4TM080L
TM100D	C11E3TM100L	C11E6TM100L	C11E4TM100L
TM125D	C12E3TM125L	C12E6TM125L	C12E4TM125L
TM160D	C12E3TM160L	C12E6TM160L	C12E4TM160L

Compression lug/busbar connectors

Rating	3P	4P 3d	4P 4d
TM16D	C11E3TM016B	C11E6TM016B	C11E4TM016B
TM25D	C11E3TM025B	C11E6TM025B	C11E4TM025B
TM32D	C11E3TM032B	C11E6TM032B	C11E4TM032B
TM40D	C11E3TM040B	C11E6TM040B	C11E4TM040B
TM50D	C11E3TM050B	C11E6TM050B	C11E4TM050B
TM63D	C11E3TM063B	C11E6TM063B	C11E4TM063B
TM80D	C11E3TM080B	C11E6TM080B	C11E4TM080B
TM100D	C11E3TM100B	C11E6TM100B	C11E4TM100B
TM125D	C12E3TM125B	C12E6TM125B	C12E4TM125B
TM160D	C12E3TM160B	C12E6TM160B	C12E4TM160B

DB438974.ai

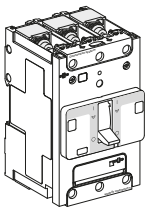

ComPacT NSXm B (25 KA at 380/415 V)

With thermal-magnetic trip unit TM-D

DB438973.ai

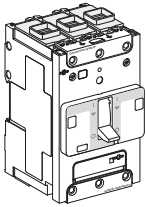

EverLink™ connectors

Rating	3P	4P 3d	4P 4d
TM16D	C11B3TM016L	C11B6TM016L	C11B4TM016L
TM25D	C11B3TM025L	C11B6TM025L	C11B4TM025L
TM32D	C11B3TM032L	C11B6TM032L	C11B4TM032L
TM40D	C11B3TM040L	C11B6TM040L	C11B4TM040L
TM50D	C11B3TM050L	C11B6TM050L	C11B4TM050L
TM63D	C11B3TM063L	C11B6TM063L	C11B4TM063L
TM80D	C11B3TM080L	C11B6TM080L	C11B4TM080L
TM100D	C11B3TM100L	C11B6TM100L	C11B4TM100L
TM125D	C12B3TM125L	C12B6TM125L	C12B4TM125L
TM160D	C12B3TM160L	C12B6TM160L	C12B4TM160L

Compression lug/busbar connectors

Rating	3P	4P 3d	4P 4d
TM16D	C11B3TM016B	C11B6TM016B	C11B4TM016B
TM25D	C11B3TM025B	C11B6TM025B	C11B4TM025B
TM32D	C11B3TM032B	C11B6TM032B	C11B4TM032B
TM40D	C11B3TM040B	C11B6TM040B	C11B4TM040B
TM50D	C11B3TM050B	C11B6TM050B	C11B4TM050B
TM63D	C11B3TM063B	C11B6TM063B	C11B4TM063B
TM80D	C11B3TM080B	C11B6TM080B	C11B4TM080B
TM100D	C11B3TM100B	C11B6TM100B	C11B4TM100B
TM125D	C12B3TM125B	C12B6TM125B	C12B4TM125B
TM160D	C12B3TM160B	C12B6TM160B	C12B4TM160B

DB438974.ai

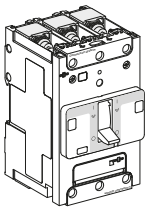

F

Complete Fixed Device

ComPacT NSXm F/N (36/50 KA at 380/415 V)

ComPacT NSXm F (36 KA at 380/415 V)

With thermal-magnetic trip unit TM-D

DB436973.ai

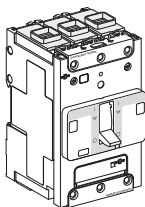

EverLink™ connectors

Rating	3P	4P 3d	4P 4d
TM16D	C11F3TM016L	C11F6TM016L	C11F4TM016L
TM25D	C11F3TM025L	C11F6TM025L	C11F4TM025L
TM32D	C11F3TM032L	C11F6TM032L	C11F4TM032L
TM40D	C11F3TM040L	C11F6TM040L	C11F4TM040L
TM50D	C11F3TM050L	C11F6TM050L	C11F4TM050L
TM63D	C11F3TM063L	C11F6TM063L	C11F4TM063L
TM80D	C11F3TM080L	C11F6TM080L	C11F4TM080L
TM100D	C11F3TM100L	C11F6TM100L	C11F4TM100L
TM125D	C12F3TM125L	C12F6TM125L	C12F4TM125L
TM160D	C12F3TM160L	C12F6TM160L	C12F4TM160L

DB436974.ai

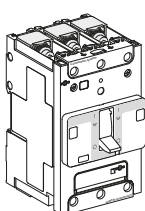

Compression lug/busbar connectors

Rating	3P	4P 3d	4P 4d
TM16D	C11F3TM016B	C11F6TM016B	C11F4TM016B
TM25D	C11F3TM025B	C11F6TM025B	C11F4TM025B
TM32D	C11F3TM032B	C11F6TM032B	C11F4TM032B
TM40D	C11F3TM040B	C11F6TM040B	C11F4TM040B
TM50D	C11F3TM050B	C11F6TM050B	C11F4TM050B
TM63D	C11F3TM063B	C11F6TM063B	C11F4TM063B
TM80D	C11F3TM080B	C11F6TM080B	C11F4TM080B
TM100D	C11F3TM100B	C11F6TM100B	C11F4TM100B
TM125D	C12F3TM125B	C12F6TM125B	C12F4TM125B
TM160D	C12F3TM160B	C12F6TM160B	C12F4TM160B

ComPacT NSXm N (50 KA at 380/415 V)

With thermal-magnetic trip unit TM-D

DB436973.ai

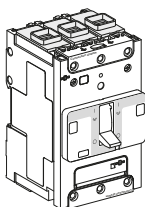

EverLink™ connectors

Rating	3P	4P 3d	4P 4d
TM16D	C11N3TM016L	C11N6TM016L	C11N4TM016L
TM25D	C11N3TM025L	C11N6TM025L	C11N4TM025L
TM32D	C11N3TM032L	C11N6TM032L	C11N4TM032L
TM40D	C11N3TM040L	C11N6TM040L	C11N4TM040L
TM50D	C11N3TM050L	C11N6TM050L	C11N4TM050L
TM63D	C11N3TM063L	C11N6TM063L	C11N4TM063L
TM80D	C11N3TM080L	C11N6TM080L	C11N4TM080L
TM100D	C11N3TM100L	C11N6TM100L	C11N4TM100L
TM125D	C12N3TM125L	C12N6TM125L	C12N4TM125L
TM160D	C12N3TM160L	C12N6TM160L	C12N4TM160L

DB436974.ai

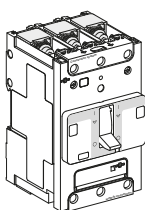

Compression lug/busbar connectors

Rating	3P	4P 3d	4P 4d
TM16D	C11N3TM016B	C11N6TM016B	C11N4TM016B
TM25D	C11N3TM025B	C11N6TM025B	C11N4TM025B
TM32D	C11N3TM032B	C11N6TM032B	C11N4TM032B
TM40D	C11N3TM040B	C11N6TM040B	C11N4TM040B
TM50D	C11N3TM050B	C11N6TM050B	C11N4TM050B
TM63D	C11N3TM063B	C11N6TM063B	C11N4TM063B
TM80D	C11N3TM080B	C11N6TM080B	C11N4TM080B
TM100D	C11N3TM100B	C11N6TM100B	C11N4TM100B
TM125D	C12N3TM125B	C12N6TM125B	C12N4TM125B
TM160D	C12N3TM160B	C12N6TM160B	C12N4TM160B



Complete Fixed Device

ComPacT NSXm H (70 KA at 380/415 V)

ComPacT NSXm H (70 KA at 380/415 V)

With thermal-magnetic trip unit TM-D

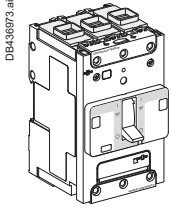

EverLink™ connectors

Rating	3P	4P 3d	4P 4d
TM16D	C11H3TM016L	C11H6TM016L	C11H4TM016L
TM25D	C11H3TM025L	C11H6TM025L	C11H4TM025L
TM32D	C11H3TM032L	C11H6TM032L	C11H4TM032L
TM40D	C11H3TM040L	C11H6TM040L	C11H4TM040L
TM50D	C11H3TM050L	C11H6TM050L	C11H4TM050L
TM63D	C11H3TM063L	C11H6TM063L	C11H4TM063L
TM80D	C11H3TM080L	C11H6TM080L	C11H4TM080L
TM100D	C11H3TM100L	C11H6TM100L	C11H4TM100L
TM125D	C12H3TM125L	C12H6TM125L	C12H4TM125L
TM160D	C12H3TM160L	C12H6TM160L	C12H4TM160L

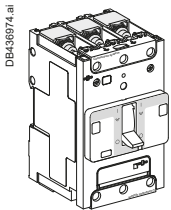

Compression lug/busbar connectors

Rating	3P	4P 3d	4P 4d
TM16D	C11H3TM016B	C11H6TM016B	C11H4TM016B
TM25D	C11H3TM025B	C11H6TM025B	C11H4TM025B
TM32D	C11H3TM032B	C11H6TM032B	C11H4TM032B
TM40D	C11H3TM040B	C11H6TM040B	C11H4TM040B
TM50D	C11H3TM050B	C11H6TM050B	C11H4TM050B
TM63D	C11H3TM063B	C11H6TM063B	C11H4TM063B
TM80D	C11H3TM080B	C11H6TM080B	C11H4TM080B
TM100D	C11H3TM100B	C11H6TM100B	C11H4TM100B
TM125D	C12H3TM125B	C12H6TM125B	C12H4TM125B
TM160D	C12H3TM160B	C12H6TM160B	C12H4TM160B

Complete Fixed Device

ComPacT NSXm MicroLogic Vigi 4.1 E/B/F

(16/25/36 KA at 380/415 V)

ComPacT NSXm MicroLogic Vigi 4.1 E (16 KA at 380/415 V)

With MicroLogic Vigi 4.1

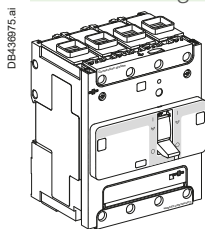

EverLink™ connectors

Rating	3P	4P
25 A	C11E34V025L	C11E44V025L
50 A	C11E34V050L	C11E44V050L
100 A	C11E34V100L	C11E44V100L
160 A	C12E34V160L	C12E44V160L

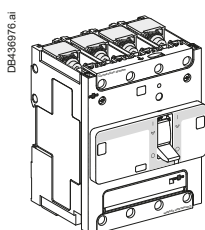

Compression lug/busbar connectors

Rating	3P	4P
25 A	C11E34V025B	C11E44V025B
50 A	C11E34V050B	C11E44V050B
100 A	C11E34V100B	C11E44V100B
160 A	C12E34V160B	C12E44V160B

ComPacT NSXm MicroLogic Vigi 4.1 B (25 KA at 380/415 V)

With MicroLogic Vigi 4.1

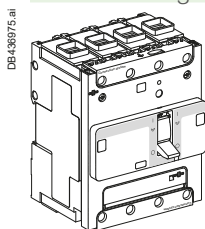

EverLink™ connectors

Rating	3P	4P
25 A	C11B34V025L	C11B44V025L
50 A	C11B34V050L	C11B44V050L
100 A	C11B34V100L	C11B44V100L
160 A	C12B34V160L	C12B44V160L

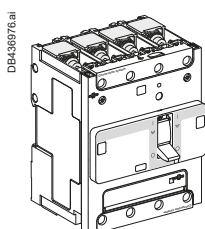

Compression lug/busbar connectors

Rating	3P	4P
25 A	C11B34V025B	C11B44V025B
50 A	C11B34V050B	C11B44V050B
100 A	C11B34V100B	C11B44V100B
160 A	C12B34V160B	C12B44V160B

ComPacT NSXm MicroLogic Vigi 4.1 F (36 KA at 380/415 V)

With MicroLogic Vigi 4.1

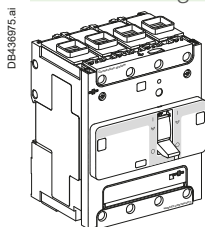

EverLink™ connectors

Rating	3P	4P
25 A	C11F34V025L	C11F44V025L
50 A	C11F34V050L	C11F44V050L
100 A	C11F34V100L	C11F44V100L
160 A	C12F34V160L	C12F44V160L

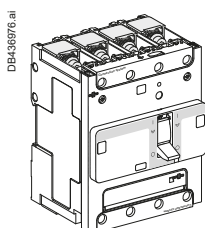

Compression lug/busbar connectors

Rating	3P	4P
25 A	C11F34V025B	C11F44V025B
50 A	C11F34V050B	C11F44V050B
100 A	C11F34V100B	C11F44V100B
160 A	C12F34V160B	C12F44V160B



Complete Fixed Device

ComPacT NSXm MicroLogic Vigi 4.1 N/H (50/70 KA at 380/415 V)

ComPacT NSXm MicroLogic Vigi 4.1 N (50 KA at 380/415 V)

With MicroLogic Vigi 4.1

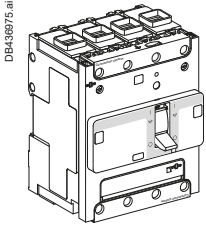

EverLink™ connectors		
Rating	3P	4P
25 A	C11N34V025L	C11N44V025L
50 A	C11N34V050L	C11N44V050L
100 A	C11N34V100L	C11N44V100L
160 A	C12N34V160L	C12N44V160L

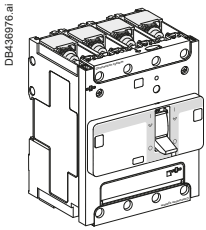

Compression lug/busbar connectors		
Rating	3P	4P
25 A	C11N34V025B	C11N44V025B
50 A	C11N34V050B	C11N44V050B
100 A	C11N34V100B	C11N44V100B
160 A	C12N34V160B	C12N44V160B

ComPacT NSXm MicroLogic Vigi 4.1 H (70 KA at 380/415 V)

With MicroLogic Vigi 4.1

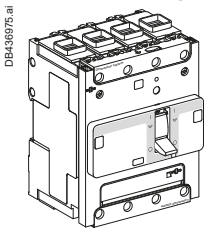

EverLink™ connectors		
Rating	3P	4P
25 A	C11H34V025L	C11H44V025L
50 A	C11H34V050L	C11H44V050L
100 A	C11H34V100L	C11H44V100L
160 A	C12H34V160L	C12H44V160L

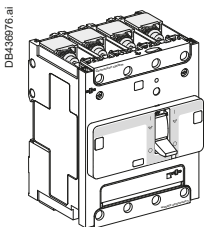

Compression lug/busbar connectors		
Rating	3P	4P
25 A	C11H34V025B	C11H44V025B
50 A	C11H34V050B	C11H44V050B
100 A	C11H34V100B	C11H44V100B
160 A	C12H34V160B	C12H44V160B

F

ComPacT NSXm NA Switch-Disconnecter

DB438973.ai

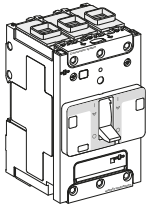

EverLink™ connectors		
Rating	3P	4P
50NA	C113050LS	C114050LS
100NA	C113100LS	C114100LS
160NA	C123160LS	C124160LS

DB438974.ai

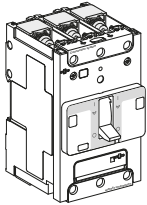

Compression lug/busbar connectors		
Rating	3P	4P
50NA	C113050BS	C114050BS
100NA	C113100BS	C114100BS
160NA	C123160BS	C124160BS



Accessories

Connection and Insulation

Connection Accessories (Cu or Al)

Bare cable connectors

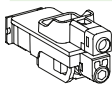
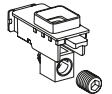
 DB421533.eps	Everlink connector with control wire terminal	1x (2.5 to 95 mm ²); ≤ 160 A Cu or ≤ 100 A Al	Set of 3	LV426970
			Set of 4	LV426971
 DB418793.eps	Aluminium connector	1x (2.5 to 70 mm ²); ≤ 125 A Cu or Al	Set of 2	LV426966
			Set of 3	LV426967

Compression lugs/busbar connectors

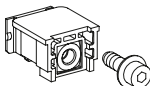
 DB421537.eps	Terminal with nuts and screws M6	≤ 160 A	Set of 3	LV426960
			Set of 4	LV426961

Terminal extensions

 DB421538.eps	Spreaders from 27 to 35 mm pitch ^[1]	3P	LV426940
		4P	LV426941

Crimp lugs for copper cable ^[1]

 DB421538.eps	For cable 50 mm ²	Set of 3	LV426978
		Set of 4	LV426979
	For cable 70 mm ²	Set of 3	LV426980
		Set of 4	LV426981
	For cable 95 mm ²	Set of 3	LV426982
		Set of 4	LV426983

Crimp lugs for aluminium cable ^[1]

 DB421540.eps	For cable 95 mm ² rigid	Set of 3	LV426984
		Set of 4	LV426985
	For cable 120 mm ² rigid	Set of 3	LV426976
		Set of 4	LV426977

Torque limiting breakaway bits

 DB421541.eps	9 N.m	Set of 6	LV426990
		Set of 8	LV426991
	5 N.m	Set of 6	LV426992
		Set of 8	LV426993

Insulation Accessories

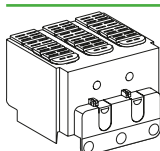
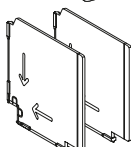
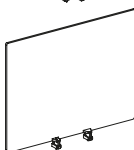
 DB421542.eps	1 long terminal shield	3P	LV426912
		4P	LV426913
 DB421543.eps	Interphase barriers	Set of 6	LV426920
 DB21544eps	2 rear insulation screens	3P	LV426922
		4P	LV426923

^[1] Supplied with 2 or 3 interphase barriers.

F

Electrical Auxiliaries

Auxiliary contacts (wired, screwless)

	Standard OF or SD	LV426950
---	-------------------	----------

Auxiliary contacts (wireless)



	Zigbee auxiliary contact	LV429453
---	--------------------------	----------

	Pre-wired OF ^[1]	LV426951
	Pre-wired SD ^[1]	LV426952

SDx for MicroLogic Vigi 4.1

	SDx module 24-250 V AC/DC	LV426900
---	---------------------------	----------

Voltage releases

	Standard	Voltage	MX	MN			
	AC	24 V 50/60 Hz	LV426841	LV426801			
		48 V 50/60 Hz	LV426842	LV426802			
		110...130 V 50/60 Hz	LV426843	LV426803			
		220...240 V 50 Hz	LV426844	LV426804			
		208...240 V 60 Hz					
		277 V 60 Hz	LV426844	LV426805			
		380...415 V 50 Hz	LV426846	LV426806			
		440...480 V 60 Hz	LV426846	LV426807			
		DC	12 V DC	LV426850	-		
			24 V DC	LV426841	LV426801		
48 V DC	LV426842		LV426802				
125 V DC	LV426843		LV426803				
250 V DC	LV426844		LV426815				
	Pre-wired ^[1]	Voltage	MX	MN			
			AC	24 V 50/60 Hz	LV426861	LV426821	
				48 V 50/60 Hz	LV426862	LV426822	
				110...130 V 50/60 Hz	LV426863	LV426823	
				220...240 V 50 Hz	LV426864	LV426824	
				208...240 V 60 Hz			
				277 V 60 Hz	LV426864	LV426825	
				380...415 V 50 Hz	LV426866	LV426826	
				440...480 V 60 Hz	LV426866	LV426827	
				DC	12 V DC	LV426870	-
					24 V DC	LV426861	LV426821
			48 V DC		LV426862	LV426822	
			125 V DC		LV426863	LV426823	
			250 V DC		LV426864	LV426835	

Time delay unit for undervoltage release (MN)

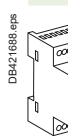
	MN 48 V 50/60 Hz with fixed time delay		
	Composed of:	MN 48 V DC	LV426802
		Delay unit 48 V 50/60 Hz	LV429426
	MN 220-240 V 50/60 Hz with fixed time delay		
	Composed of:	MN 250 V DC	LV426815
		Delay unit 220-240 V 50/60 Hz	LV429427
	MN 48 V DC/AC 50/60 Hz with adjustable time delay		
	Composed of:	MN 48 V DC	LV426802
		Delay unit 48 V DC/AC 50/60 Hz	33680
	MN 110-130 V DC/AC 50/60 Hz with adjustable time delay		
	Composed of:	MN 125 V DC	LV426803
		Delay unit 100-130 V DC/AC 50/60 Hz	33681
	MN 220-250 V DC/AC 50/60 Hz with adjustable time delay		
	Composed of:	MN 250 V DC	LV426815
		Delay unit 200-250 V DC/AC 50-60 Hz	33682

[1] Cable: 1 meter long - AWG 18 - 480 V UL certified.



Accessories



Rotary Handles, Locks and Seals

Rotary Handle

Direct rotary handle

DB438286.ai 	With black handle	LV426930T
	With red handle on yellow front	LV426931T

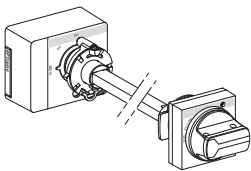
Extended rotary handle

DB438287.ai 	With black handle IP54	LV426932T
	With red handle on yellow front IP54	LV426933T
	With red handle on yellow front IP65	LV426934T
DB421689.eps 	Open door shaft operator	LV426937
DB421677.eps 	Laser tool	GVAPL01

Side rotary handle

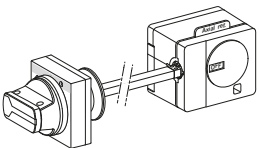

DB438288.ai 	With black handle IP54	LV426935T
	With red handle on yellow front IP54	LV426936T

Universal handle

DB438289.ai 	Black handle IP54 (spare part for replacement of front, ext. or side rotary handle)	LV426997T
	Red handle on yellow front IP54	LV426998T
	Red handle on yellow front IP65	LV426999T

Locks

Toggle locking device for 1 to 3 padlocks

DB425951.eps 	By removable device	29370
	By fixed device (OFF or ON)	LV426905
DB421555.eps 	By fixed device (OFF or ON)	LV426905
DB421690.eps 	By fixed device (OFF only)	LV426906

Lead - Sealing Accessories

DB421556.eps 	Bag of accessories	LV429375
---	--------------------	----------

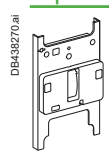
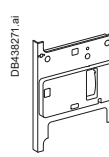
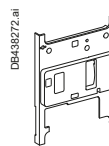

F

Spare Parts

	Front cover	3P	LV426946
		4P	LV426947
		ELCB ^[1]	LV426948

Test Tool, Software, Demo

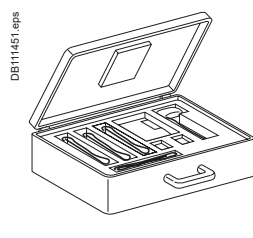
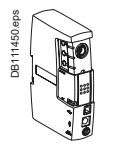
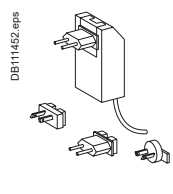
Test tool

	Pocket battery for MicroLogic	LV434206
	Maintenance case Comprising: <ul style="list-style-type: none"> ■ USB maintenance interface ■ Power supply ■ MicroLogic cord ■ USB cord ■ RJ45/RJ45 male cord 	TRV00910
	Spare USB maintenance interface	TRV00911
	Spare power supply 110-240 V AC	TRV00915
	Spare MicroLogic cord for USB maintenance interface	TRV00917

[1] ELCB: Earth Leakage Circuit Breaker.





F

Catalog Numbers: ComPacT NSX100-250

Complete Fixed Device

ComPacT NSX100/160 1P-2P NSX250N 1P	F-16
ComPacT NSX100/160/250B (25 KA 380/415 V)	F-17
ComPacT NSX100/160/250F (36 KA 380/415 V)	F-18
ComPacT NSX100/160/250N (50 KA 380/415 V)	F-20
ComPacT NSX100/160/250H (70 KA 380/415 V)	F-22
ComPacT NSX100/250R (200 KA 380/415 V - 45 KA 690 V)	F-24
ComPacT NSX100/250HB1 (85 KA 500 V - 75 KA 690 V)	F-26
ComPacT NSX100/250HB2 (100 KA 500 V - 100 KA 690 V)	F-28
ComPacT NSX100/160/250NA	F-30

Based on Separate Components

ComPacT NSX100/160/250	F-31
------------------------------	------

Trip Unit Accessories

ComPacT NSX100/160/250	F-34
------------------------------	------

Installation and Connection

ComPacT NSX100/160/250	F-35
------------------------------	------

Accessories and Auxiliaries

ComPacT NSX100/160/250	F-36
------------------------------	------



Other Chapters

Select Circuit Breakers and Switch-Disconnectors	A-1
Select Protection	B-1
Customize Circuit Breakers with Accessories	C-1
Smart Panel Integration	D-1
Switchboard Integration	E-1
Glossary	G-1
Additional Characteristics	H-1

Complete Fixed Device

ComPacT NSX100/160 1P-2P NSX250N 1P

ComPacT NSX100/160 F/N/M/S 1P/2P

With thermal-magnetic trip unit TM-D

DB438977.ai

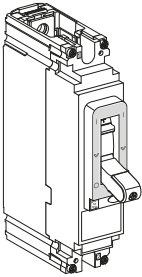

ComPacT NSX100F AC/DC

Rating	1P 1d (Icu = 18 kA 220/240 V AC)	2P 2d (Icu = 18 kA 380/415 V AC)
TM16D	C10F1TM016	C10F2TM016
TM20D	C10F1TM020	C10F2TM020
TM25D	C10F1TM025	C10F2TM025
TM30D	C10F1TM030	C10F2TM030
TM40D	C10F1TM040	C10F2TM040
TM50D	C10F1TM050	C10F2TM050
TM63D	C10F1TM063	C10F2TM063
TM80D	C10F1TM080	C10F2TM080
TM100D	C10F1TM100	C10F2TM100

ComPacT NSX100F AC/DC

ComPacT NSX160F AC/DC

Rating	1P 1d (Icu = 18 kA 220/240 V AC)	2P 2d (Icu = 18 kA 380/415 V AC)
TM125D	C16F1TM125	C16F2TM125
TM160D	C16F1TM160	C16F2TM160

ComPacT NSX160F AC/DC

DB436978.ai

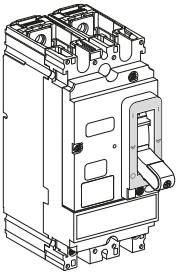

ComPacT NSX100N AC/DC

Rating	1P 1d (Icu = 25 kA 220/240 V AC)	2P 2d (Icu = 25 kA 380/415 V AC)
TM16D	C10N1TM016	C10M2TM016
TM20D	C10N1TM020	C10M2TM020
TM25D	C10N1TM025	C10M2TM025
TM30D	C10N1TM030	C10M2TM030
TM40D	C10N1TM040	C10M2TM040
TM50D	C10N1TM050	C10M2TM050
TM63D	C10N1TM063	C10M2TM063
TM80D	C10N1TM080	C10M2TM080
TM100D	C10N1TM100	C10M2TM100

ComPacT NSX100M AC/DC

ComPacT NSX160N AC/DC

Rating	1P 1d (Icu = 25 kA 220/240 V AC)	2P 2d (Icu = 40 kA 380/415 V AC)
TM125D	C16N1TM125	C16M2TM125
TM160D	C16N1TM160	C16M2TM160

ComPacT NSX160M AC/DC

ComPacT NSX100M AC/DC

Rating	1P 1d (Icu = 40 kA 220/240 V AC)	2P 2d (Icu = 70 kA 380/415 V AC)
TM16D	C10M1TM016	C10S2TM016
TM20D	C10M1TM020	C10S2TM020
TM25D	C10M1TM025	C10S2TM025
TM30D	C10M1TM030	C10S2TM030
TM40D	C10M1TM040	C10S2TM040
TM50D	C10M1TM050	C10S2TM050
TM63D	C10M1TM063	C10S2TM063
TM80D	C10M1TM080	C10S2TM080
TM100D	C10M1TM100	C10S2TM100

ComPacT NSX100S AC/DC

ComPacT NSX160M AC/DC

Rating	1P 1d (Icu = 40 kA 220/240 V AC)	2P 2d (Icu = 70 kA 380/415 V AC)
TM125D	C16M1TM125	C16S2TM125
TM160D	C16M1TM160	C16S2TM160

ComPacT NSX160S AC/DC

ComPacT NSX250 N 1P

With thermal-magnetic trip unit TM-D

ComPacT NSX250N AC

Rating	1P 1d (Icu = 25 kA 220/240 V AC)
TM160D	C25N1TM160
TM200D	C25N1TM200
TM250D	C25N1TM250

F

Complete Fixed Device

ComPacT NSX100/160/250B (25 KA 380/415 V)

ComPacT NSX100/160/250B

With thermal-magnetic trip unit TM-D

DB-438166.ai

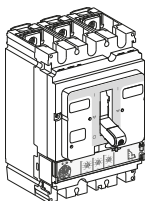

ComPacT NSX100B (25 kA at 380/415 V)

Rating	3P 3d	4P 3d	4P 4d
TM16D	C10B3TM016	C10B6TM016	C10B4TM016
TM25D	C10B3TM025	C10B6TM025	C10B4TM025
TM32D	C10B3TM032	C10B6TM032	C10B4TM032
TM40D	C10B3TM040	C10B6TM040	C10B4TM040
TM50D	C10B3TM050	C10B6TM050	C10B4TM050
TM63D	C10B3TM063	C10B6TM063	C10B4TM063
TM80D	C10B3TM080	C10B6TM080	C10B4TM080
TM100D	C10B3TM100	C10B6TM100	C10B4TM100

ComPacT NSX160B (25 kA at 380/415 V)

Rating	3P 3d	4P 3d	4P 4d
TM80D	C16B3TM080	C16B6TM080	C16B4TM080
TM100D	C16B3TM100	C16B6TM100	C16B4TM100
TM125D	C16B3TM125	C16B6TM125	C16B4TM125
TM160D	C16B3TM160	C16B6TM160	C16B4TM160

ComPacT NSX250B (25 kA at 380/415 V)

Rating	3P 3d	4P 3d	4P 4d
TM125D	C25B3TM125	C25B6TM125	C25B4TM125
TM160D	C25B3TM160	C25B6TM160	C25B4TM160
TM200D	C25B3TM200	C25B6TM200	C25B4TM200
TM250D	C25B3TM250	C25B6TM250	C25B4TM250

With electronic trip unit MicroLogic 2.2 (LS_oI protection)

DB-438167.ai

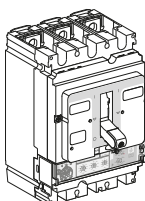

ComPacT NSX100B (25 kA at 380/415 V)

Rating	3P 3d	4P 3d, 4d, 3d + N/2
40	C10B32D040	C10B42D040
100	C10B32D100	C10B42D100

ComPacT NSX160B (25 kA at 380/415 V)

Rating	3P 3d	4P 3d, 4d, 3d + N/2
100	C16B32D100	C16B42D100
160	C16B32D160	C16B42D160

ComPacT NSX250B (25 kA at 380/415 V)

Rating	3P 3d	4P 3d, 4d, 3d + N/2
100	C25B32D100	C25B42D100
160	C25B32D160	C25B42D160
250	C25B32D250	C25B42D250

With electronic trip unit MicroLogic Vigi 4.2 (LS_oIR protection)

DB-438168.ai

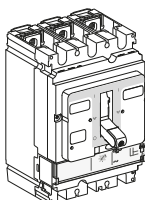

ComPacT NSX100B (25 kA 380/415V)

Rating	3P 3d	4P 4d, 3d + N/2
40 A	C10B34V040	C10B44V040
100 A	C10B34V100	C10B44V100

ComPacT NSX160B (25 kA 380/415V)

Rating	3P 3d	4P 4d, 3d + N/2
100 A	C16B34V100	C16B44V100
160 A	C16B34V160	C16B44V160

ComPacT NSX250B (25 kA 380/415V)

Rating	3P 3d	4P 4d, 3d + N/2
100 A	C25B34V100	C25B44V100
160 A	C25B34V160	C25B44V160
250 A	C25B34V250	C25B44V250

With electronic trip unit MicroLogic 5.2 E (LSI protection, energy meter)

Only available as separate component or through online configurator (product selector)

With electronic trip unit MicroLogic 6.2 E (LSIG protection, energy meter)

Only available as separate component or through online configurator (product selector)

With electronic trip unit MicroLogic 7.2 E (LSIG protection, energy meter)

Only available as separate component or through online configurator (product selector)



Complete Fixed Device

ComPacT NSX100/160/250F (36 kA 380/415 V)

ComPacT NSX100/160/250F

With thermal-magnetic trip unit TM-D

DB438165.ai

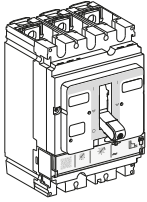

ComPacT NSX100F (36 kA at 380/415 V)

Rating	3P 3d	4P 3d	4P 4d
TM16D	C10F3TM016	C10F6TM016	C10F4TM016
TM25D	C10F3TM025	C10F6TM025	C10F4TM025
TM32D	C10F3TM032	C10F6TM032	C10F4TM032
TM40D	C10F3TM040	C10F6TM040	C10F4TM040
TM50D	C10F3TM050	C10F6TM050	C10F4TM050
TM63D	C10F3TM063	C10F6TM063	C10F4TM063
TM80D	C10F3TM080	C10F6TM080	C10F4TM080
TM100D	C10F3TM100	C10F6TM100	C10F4TM100

ComPacT NSX160F (36 kA at 380/415 V)

Rating	3P 3d	4P 3d	4P 4d
TM80D	C16F3TM080	C16F6TM080	C10F4TM050
TM100D	C16F3TM100	C16F6TM100	C10F4TM100
TM125D	C16F3TM125	C16F6TM125	C10F4TM125
TM160D	C16F3TM160	C16F6TM160	C10F4TM160

ComPacT NSX250F (36 kA at 380/415 V)

Rating	3P 3d	4P 3d	4P 4d
TM125D	C25F3TM125	C25F6TM125	C25F4TM125
TM160D	C25F3TM160	C25F6TM160	C25F4TM160
TM200D	C25F3TM200	C25F6TM200	C25F4TM200
TM250D	C25F3TM250	C25F6TM250	C25F4TM250

With electronic trip unit MicroLogic 2.2 (LS_oI protection)

DB438166.ai

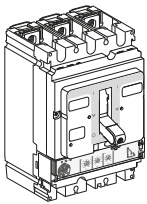

ComPacT NSX100F (36 kA at 380/415 V)

Rating	3P 3d	4P 3d, 4d, 3d + N/2
40	C10F32D040	C10F42D040
100	C10F32D100	C10F42D100

ComPacT NSX160F (36 kA at 380/415 V)

Rating	3P 3d	4P 3d, 4d, 3d + N/2
100	C16F32D100	C16F42D100
160	C16F32D160	C16F42D160

ComPacT NSX250F (36 kA at 380/415 V)

Rating	3P 3d	4P 3d, 4d, 3d + N/2
100	C25F32D100	C25F42D100
160	C25F32D160	C25F42D160
250	C25F32D250	C25F42D250

With electronic trip unit MicroLogic Vigi 4.2 (LS_oIR protection)

DB438167.ai

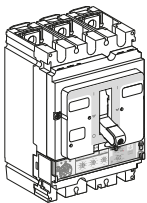

ComPacT NSX100F (36 kA 380/415V)

Rating	3P 3d	4P 4d, 3d + N/2
40 A	C10F34V040	C10F44V040
100 A	C10F34V100	C10F44V100

ComPacT NSX160F (36 kA 380/415V)

Rating	3P 3d	4P 4d, 3d + N/2
100 A	C16F34V100	C16F44V100
160 A	C16F34V160	C16F44V160

ComPacT NSX250F (36 kA 380/415V)

Rating	3P 3d	4P 4d, 3d + N/2
100 A	C25F34V100	C25F44V100
160 A	C25F34V160	C25F44V160
250 A	C25F34V250	C25F44V250

With electronic trip unit MicroLogic 5.2 E (LSI protection, energy meter)

Only available as separate component or through online configurator (product selector)

With electronic trip unit MicroLogic 6.2 E (LSIG protection, energy meter)

Only available as separate component or through online configurator (product selector)

With electronic trip unit MicroLogic 7.2 E (LSIG protection, energy meter)

Only available as separate component or through online configurator (product selector)

F

Complete Fixed Device

ComPacT NSX100/160/250F (36 KA 380/415 V)

ComPacT NSX100/160/250F

With magnetic trip unit MA

DE-439168.ai

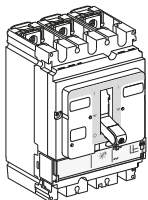

ComPacT NSX100F (36 kA at 380/415 V)

Rating	3P 3d
MA2.5	C10F3MA003
MA6.3	C10F3MA007
MA12.5	C10F3MA013
MA25	C10F3MA025
MA50	C10F3MA050
MA100	C10F3MA100

ComPacT NSX160F (36 kA at 380/415 V)

Rating	3P 3d
MA100	C16F3MA100
MA150	C16F3MA150

ComPacT NSX250F (36 kA at 380/415 V)

Rating	3P 3d
MA150	C25F3MA150
MA220	C25F3MA220

With electronic trip unit MicroLogic 6.2 E-M (LSIG motor protection, energy meter)

Only available as separate component or through online configurator (product selector)



Complete Fixed Device

ComPacT NSX100/160/250N (50 KA 380/415 V)

ComPacT NSX100/160/250N

With thermal-magnetic trip unit TM-D

DB438165.ai

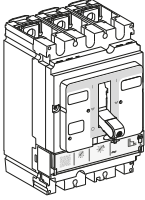

ComPacT NSX100N (50 kA at 380/415 V)

Rating	3P 3d	4P 3d	4P 4d
TM16D	C10N3TM016	C10N6TM016	C10N4TM016
TM25D	C10N3TM025	C10N6TM025	C10N4TM025
TM32D	C10N3TM032	C10N6TM032	C10N4TM032
TM40D	C10N3TM040	C10N6TM040	C10N4TM040
TM50D	C10N3TM050	C10N6TM050	C10N4TM050
TM63D	C10N3TM063	C10N6TM063	C10N4TM063
TM80D	C10N3TM080	C10N6TM080	C10N4TM080
TM100D	C10N3TM100	C10N6TM100	C10N4TM100

ComPacT NSX160N (50 kA at 380/415 V)

Rating	3P 3d	4P 3d	4P 4d
TM80D	C16N3TM080	C16N6TM080	C16N4TM080
TM100D	C16N3TM100	C16N6TM100	C16N4TM100
TM125D	C16N3TM125	C16N6TM125	C16N4TM125
TM160D	C16N3TM160	C16N6TM160	C16N4TM160

ComPacT NSX250N (50 kA at 380/415 V)

Rating	3P 3d	4P 3d	4P 4d
TM125D	C25N3TM125	C25N6TM125	C25N4TM125
TM160D	C25N3TM160	C25N6TM160	C25N4TM160
TM200D	C25N3TM200	C25N6TM200	C25N4TM200
TM250D	C25N3TM250	C25N6TM250	C25N4TM250

With electronic trip unit MicroLogic 2.2 (LS_oI protection)

DB438166.ai

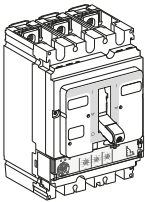

ComPacT NSX100N (50 kA at 380/415 V)

Rating	3P 3d	4P 3d, 4d, 3d + N/2
40 A	C10N32D040	C10N42D040
100 A	C10N32D100	C10N42D100

ComPacT NSX160N (50 kA at 380/415 V)

Rating	3P 3d	4P 3d, 4d, 3d + N/2
100 A	C16N32D100	C16N42D100
160 A	C16N32D160	C16N42D160

ComPacT NSX250N (50 kA at 380/415 V)

Rating	3P 3d	4P 3d, 4d, 3d + N/2
100 A	C25N32D100	C25N42D100
160 A	C25N32D160	C25N42D160
250 A	C25N32D250	C25N32D250

With electronic trip unit MicroLogic Vigi 4.2 (LS_oIR protection)

DB438167.ai

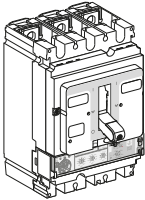

ComPacT NSX100N (50 kA 380/415V)

Rating	3P 3d	4P 4d, 3d + N/2
40 A	C10N34V040	C10N44V040
100 A	C10N34V100	C10N44V100

ComPacT NSX160N (50 kA 380/415V)

Rating	3P 3d	4P 4d, 3d + N/2
100 A	C16N34V100	C16N44V100
160 A	C16N34V160	C16N44V160

ComPacT NSX250N (50 kA 380/415V)

Rating	3P 3d	4P 4d, 3d + N/2
100 A	C25N34V100	C25N44V100
160 A	C25N34V160	C25N44V160
250 A	C25N34V250	C25N44V250

With electronic trip unit MicroLogic 5.2 E (LSI protection, energy meter)

Only available as separate component or through online configurator (product selector)

With electronic trip unit MicroLogic 6.2 E (LSIG protection, energy meter)

Only available as separate component or through online configurator (product selector)

With electronic trip unit MicroLogic 7.2 E (LSIG protection, energy meter)

Only available as separate component or through online configurator (product selector)

F

Complete Fixed Device

ComPacT NSX100/160/250N (50 KA 380/415 V)

ComPacT NSX100/160/250N

With magnetic trip unit MA

DB458108.ai

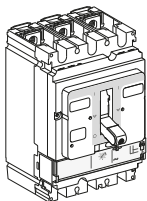

ComPacT NSX100N (50 kA at 380/415 V)

Rating	3P 3d
MA2.5	C10N3MA003
MA6.3	C10N3MA007
MA12.5	C10N3MA013
MA25	C10N3MA025
MA50	C10N3MA050
MA100	C10N3MA100

ComPacT NSX160N (50 kA at 380/415 V)

Rating	3P 3d
MA100	C16N3MA100
MA150	C16N3MA150

ComPacT NSX250N (50 kA at 380/415 V)

Rating	3P 3d
MA150	C25N3MA150
MA220	C25N3MA220

With electronic trip unit MicroLogic 6.2 E-M (LSIG motor protection, energy meter)

Only available as separate component or through online configurator (product selector)



Complete Fixed Device

ComPacT NSX100/160/250H (70 KA 380/415 V)

ComPacT NSX100/160/250H

With thermal-magnetic trip unit TM-D

DB438165.ai

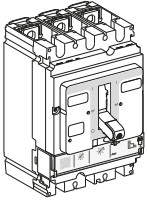

ComPacT NSX100H (70 kA at 380/415 V)

Rating	3P 3d	4P 3d	4P 4d
TM16D	C10H3TM016	C10H6TM016	C10H4TM016
TM25D	C10H3TM025	C10H6TM025	C10H4TM025
TM32D	C10H3TM032	C10H6TM032	C10H4TM032
TM40D	C10H3TM040	C10H6TM040	C10H4TM040
TM50D	C10H3TM050	C10H6TM050	C10H4TM050
TM63D	C10H3TM063	C10H6TM063	C10H4TM063
TM80D	C10H3TM080	C10H6TM080	C10H4TM080
TM100D	C10H3TM100	C10H6TM100	C10H4TM100

ComPacT NSX160H (70 kA at 380/415 V)

Rating	3P 3d	4P 3d	4P 4d
TM80D	C16H3TM080	C16H6TM080	C16H4TM080
TM100D	C16H3TM100	C16H6TM100	C16H4TM100
TM125D	C16H3TM125	C16H6TM125	C16H4TM125
TM160D	C16H3TM160	C16H6TM160	C16H4TM160

ComPacT NSX250H (70 kA at 380/415 V)

Rating	3P 3d	4P 3d	4P 4d
TM125D	C25H3TM125	C25H6TM125	C25H4TM125
TM160D	C25H3TM160	C25H6TM160	C25H4TM160
TM200D	C25H3TM200	C25H6TM200	C25H4TM200
TM250D	C25H3TM250	C25H6TM250	C25H4TM250

With electronic trip unit MicroLogic 2.2 (LS_oI protection)

DB438166.ai

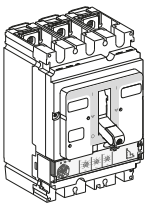

ComPacT NSX100H (70 kA at 380/415 V)

Rating	3P 3d	4P 3d, 4d, 3d + N/2
40 A	C10H32D040	C10H42D040
100 A	C10H32D100	C10H42D100

ComPacT NSX160H (70 kA at 380/415 V)

Rating	3P 3d	4P 3d, 4d, 3d + N/2
100 A	C16H32D100	C16H42D100
160 A	C16H32D160	C16H42D160

ComPacT NSX250H (70 kA at 380/415 V)

Rating	3P 3d	4P 3d, 4d, 3d + N/2
100 A	C25H32D100	C25H42D100
160 A	C25H32D160	C25H42D160
250 A	C25H32D250	C25H42D250

With electronic trip unit MicroLogic Vigi 4.2 (LS_oIR protection)

DB438167.ai

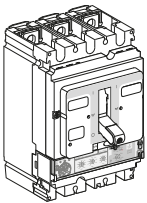

ComPacT NSX100H (70 kA 380/415V)

Rating	3P 3d	4P 4d, 3d + N/2
40 A	C10H34V040	C10H44V040
100 A	C10H34V100	C10H44V100

ComPacT NSX160H (70 kA 380/415V)

Rating	3P 3d	4P 4d, 3d + N/2
100 A	C16H34V100	C16H44V100
160 A	C16H34V160	C16H44V160

ComPacT NSX250H (70 kA 380/415V)

Rating	3P 3d	4P 4d, 3d + N/2
100 A	C25H34V100	C25H44V100
160 A	C25H34V160	C25H44V160
250 A	C25H34V250	C25H44V250

With electronic trip unit MicroLogic 5.2 E (LSI protection, energy meter)

Only available as separate component or through online configurator (product selector)

With electronic trip unit MicroLogic 6.2 E (LSIG protection, energy meter)

Only available as separate component or through online configurator (product selector)

With electronic trip unit MicroLogic 7.2 E (LSIG protection, energy meter)

Only available as separate component or through online configurator (product selector)

F

Complete Fixed Device

ComPacT NSX100/160/250H (70 kA 380/415 V)

ComPacT NSX100/160/250H

With magnetic trip unit MA

DB438168.ai

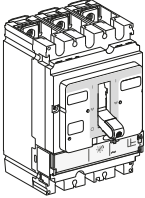

ComPacT NSX100H (70 kA at 380/415 V)

Rating	3P 3d
MA2.5	C10H3MA003
MA6.3	C10H3MA007
MA12.5	C10H3MA013
MA25	C10H3MA025
MA50	C10H3MA050
MA100	C10H3MA100

ComPacT NSX160H (70 kA at 380/415 V)

Rating	3P 3d
MA100	C16H3MA100
MA150	C16H3MA150

ComPacT NSX250H (70 kA at 380/415 V)

Rating	3P 3d
MA150	C25H3MA150
MA220	C25H3MA220

With electronic trip unit MicroLogic 2.2 M (LS_oI motor protection)

DB438166.ai

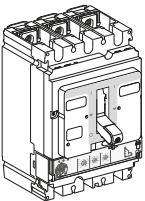

ComPacT NSX100H (70 kA at 380/415 V)

Rating	3P 3d
25 A	C10H32M025
50 A	C10H32M050
100 A	C10H32M100

ComPacT NSX160H (70 kA at 380/415 V)

Rating	3P 3d
100 A	C16H32M100
150 A	C16H32M150

ComPacT NSX250H (70 kA at 380/415 V)

Rating	3P 3d
150 A	C25H32M150
220 A	C25H32M220

With electronic trip unit MicroLogic 6.2 E-M (LSIG motor protection, energy meter)

Only available as separate component or through online configurator (product selector)

Complete Fixed Device

ComPacT NSX100/250R (200 KA 380/415 V - 45 KA 690 V)

ComPacT NSX100/250R

With thermal-magnetic trip unit TM-D

DB438105.ai

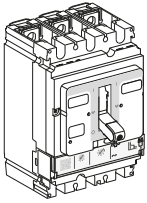

ComPacT NSX100R (200 kA at 380/415 V - 45 kA at 690 V)

Rating	3P 3d	4P 4d
TM40D	C10R3TM040	C10R4TM040
TM50D	C10R3TM050	C10R4TM050
TM63D	C10R3TM063	C10R4TM063
TM80D	C10R3TM080	C10R4TM080
TM100D	C10R3TM100	C10R4TM100

ComPacT NSX250R (200 kA at 380/415 V - 45 kA at 690 V)

Rating	3P 3d	4P 4d
TM125D	C25R3TM125	C25R4TM125
TM160D	C25R3TM160	C25R4TM160
TM200D	C25R3TM200	C25R4TM200
TM250D	C25R3TM250	C25R4TM250

With electronic trip unit MicroLogic 2.2 (LS₀I protection)

DB438106.ai

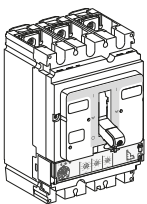

ComPacT NSX100R (200 kA at 380/415 V - 45 kA at 690 V)

Rating	3P 3d	4P 3d, 4d, 3d + N/2
40 A	C10R32D040	C10R42D040
100 A	C10R32D100	C10R42D100

ComPacT NSX250R (200 kA at 380/415 V - 45 kA at 690 V)

Rating	3P 3d	4P 3d, 4d, 3d + N/2
100 A	C25R32D100	C25R42D100
160 A	C25R32D160	C25R42D160
250 A	C25R32D250	C25R42D250

With electronic trip unit MicroLogic 5.2 E (LSI protection, energy meter)

DB438109.ai

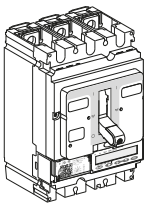

ComPacT NSX100R (200 kA at 380/415 V - 45 kA at 690 V)

Rating	3P 3d	4P 3d, 4d, 3d + N/2, OSN
40 A	C10R35E040	C10R45E040
100 A	C10R35E100	C10R45E100

ComPacT NSX250R (200 kA at 380/415 V - 45 kA at 690 V)

Rating	3P 3d	4P 3d, 4d, 3d + N/2, OSN
100 A	C25R35E100	C25R45E100
160 A	C25R35E160	C25R45E160
250 A	C25R35E250	C25R45E250

With electronic trip unit MicroLogic 6.2 E (LSIG protection, energy meter)

DB438109.ai

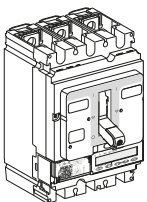

ComPacT NSX100R (200 kA at 380/415 V - 45 kA at 690 V)

Rating	3P 3d	4P 3d, 4d, 3d + N/2, OSN
40 A	C10R36E040	C10R46E040
100 A	C10R36E100	C10R46E100

ComPacT NSX250R (200 kA at 380/415 V - 45 kA at 690 V)

Rating	3P 3d	4P 3d, 4d, 3d + N/2, OSN
100 A	C25R36E100	C25R46E100
160 A	C25R36E160	C25R46E160
250 A	C25R36E250	C25R46E250

Complete Fixed Device

ComPacT NSX100/250R (200 kA 380/415 V - 45 kA 690 V)

ComPacT NSX100/250R

With magnetic trip unit MA

DB438188.ai

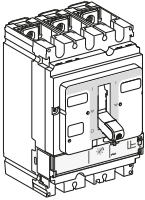

ComPacT NSX100R (200 kA at 380/415 V - 45 kA at 690 V)

Rating	3P 3d
MA12.5	C10R3MA013
MA25	C10R3MA025
MA50	C10R3MA050
MA100	C10R3MA100

ComPacT NSX250R (200 kA at 380/415 V - 45 kA at 690 V)

Rating	3P 3d
MA150	C25R3MA150
MA220	C25R3MA220

With electronic trip unit MicroLogic 2.2 M (LS_oI motor protection)

DB438189.ai

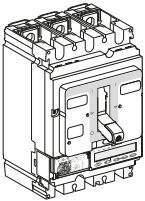

ComPacT NSX100R (200 kA at 380/415 V - 45 kA at 690 V)

Rating	3P 3d
25 A	C10R32M025
50 A	C10R32M050
100 A	C10R32M100

ComPacT NSX250R (200 kA at 380/415 V - 45 kA at 690 V)

Rating	3P 3d
150 A	C25R32M150
220 A	C25R32M220

With electronic trip unit MicroLogic 6.2 E-M (LSIG motor protection, energy meter)

DB438189.ai

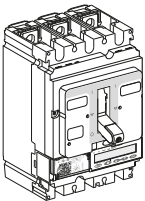

ComPacT NSX100R (200 kA at 380/415 V - 45 kA at 690 V)

Rating	3P 3d
25 A	C10R36M025
50 A	C10R36M050
80 A	C10R36M080

ComPacT NSX250R (200 kA at 380/415 V - 45 kA at 690 V)

Rating	3P 3d
150 A	C25R36M150
220 A	C25R36M220



Complete Fixed Device

ComPacT NSX100/250HB1 (85 KA 500 V - 75 KA 690 V)

ComPacT NSX100/250HB1

With thermal-magnetic trip unit TM-D

DB438108.ai

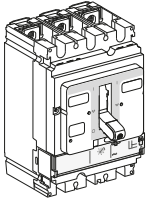

ComPacT NSX100HB1 (85 kA at 500 V - 75 kA at 690 V)

Rating	3P 3d	4P 4d
TM40D	C10V3TM040	C10V4TM040
TM50D	C10V3TM050	C10V4TM050
TM63D	C10V3TM063	C10V4TM063
TM80D	C10V3TM080	C10V4TM080
TM100D	C10V3TM100	C10V4TM100

ComPacT NSX250HB1 (85 kA at 500 V - 75 kA at 690 V)

Rating	3P 3d	4P 4d
TM125D	C25V3TM125	C25V4TM125
TM160D	C25V3TM160	C25V4TM160
TM200D	C25V3TM200	C25V4TM200
TM250D	C25V3TM250	C25V4TM250

With electronic trip unit MicroLogic 2.2 (LS_oI protection)

DB438106.ai

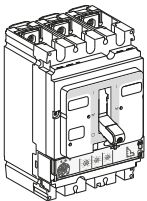

ComPacT NSX100HB1 (85 kA at 500 V - 75 kA at 690 V)

Rating	3P 3d	4P 3d, 4d, 3d + N/2
40 A	C10V32D040	C10V42D040
100 A	C10V32D100	C10V42D100

ComPacT NSX250HB1 (85 kA at 500 V - 75 kA at 690 V)

Rating	3P 3d	4P 3d, 4d, 3d + N/2
100 A	C25V32D100	C25V42D100
160 A	C25V32D160	C25V42D160
250 A	C25V32D250	C25V42D250

With electronic trip unit MicroLogic 5.2 E (LSI protection, energy meter)

DB438107.ai

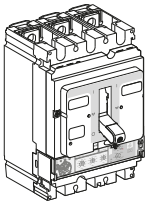

ComPacT NSX100HB1 (85 kA at 500 V - 75 kA at 690 V)

Rating	3P 3d	4P 3d, 4d, 3d + N/2, OSN
40 A	C10V35E040	C10V45E040
100 A	C10V35E100	C10V45E100

ComPacT NSX250HB1 (85 kA at 500 V - 75 kA at 690 V)

Rating	3P 3d	4P 3d, 4d, 3d + N/2, OSN
100 A	C25V35E100	C25V45E100
160 A	C25V35E160	C25V45E160
250 A	C25V35E250	C25V45E250

With electronic trip unit MicroLogic 6.2 E (LSIG protection, energy meter)

DB438109.ai

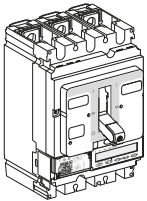

ComPacT NSX100HB1 (85 kA at 500 V - 75 kA at 690 V)

Rating	3P 3d	4P 3d, 4d, 3d + N/2, OSN
40 A	C10V36E040	C10V46E040
100 A	C10V36E100	C10V46E100

ComPacT NSX250HB1 (85 kA at 500 V - 75 kA at 690 V)

Rating	3P 3d	4P 3d, 4d, 3d + N/2, OSN
100 A	C25V36E100	C25V46E100
160 A	C25V36E160	C25V46E160
250 A	C25V36E250	C25V46E250

Complete Fixed Device

ComPacT NSX100/250HB1 (85 KA 500 V - 75 KA 690 V)

ComPacT NSX100/250HB1

With magnetic trip unit MA

DB438108.ai

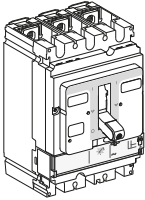

ComPacT NSX100HB1 (85 kA at 500 V - 75 kA at 690 V)

Rating	3P 3d
MA12.5	C10V3MA013
MA25	C10V3MA025
MA50	C10V3MA050
MA100	C10V3MA100

ComPacT NSX250HB1 (85 kA at 500 V - 75 kA at 690 V)

Rating	3P 3d
MA150	C25V3MA150
MA220	C25V3MA220

With electronic trip unit MicroLogic 2.2 M (LS_oI motor protection)

DB438166.ai

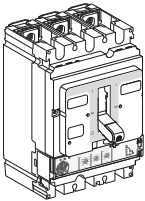

ComPacT NSX100HB1 (85 kA at 500 V - 75 kA at 690 V)

Rating	3P 3d
25 A	C10V32M025
50 A	C10V32M050
100 A	C10V32M100

ComPacT NSX250HB1 (85 kA at 500 V - 75 kA at 690 V)

Rating	3P 3d
150 A	C25V32M150
220 A	C25V32M220

With electronic trip unit MicroLogic 6.2 E-M (LSIG motor protection, energy meter)

DB438168.ai

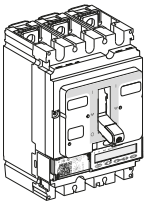

ComPacT NSX100HB1 (85 kA at 500 V - 75 kA at 690 V)

Rating	3P 3d
25 A	C10V36M025
50 A	C10V36M050
80 A	C10V36M080

ComPacT NSX250HB1 (85 kA at 500 V - 75 kA at 690 V)

Rating	3P 3d
150 A	C25V36M150
220 A	C25V36M220



Complete Fixed Device

ComPacT NSX100/250HB2 (100 kA 500 V - 100 kA 690 V)

ComPacT NSX100/250HB2

With thermal-magnetic trip unit TM-D

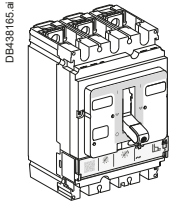

ComPacT NSX100HB2 (100 kA at 500 V - 100 kA at 690 V)

Rating	3P 3d	4P 4d
TM63D	C10W3TM063	C10W4TM063
TM80D	C10W3TM080	C10W4TM080
TM100D	C10W3TM100	C10W4TM100

ComPacT NSX250HB2 (100 kA at 500 V - 100 kA at 690 V)

Rating	3P 3d	4P 4d
TM125D	C25W3TM125	C25W4TM125
TM160D	C25W3TM160	C25W4TM160
TM200D	C25W3TM200	C25W4TM200
TM250D	C25W3TM250	C25W4TM250

With electronic trip unit MicroLogic 2.2 (LS_oI protection)

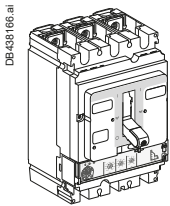

ComPacT NSX100HB2 (100 kA at 500 V - 100 kA at 690 V)

Rating	3P 3d	4P 3d, 4d, 3d + N/2
40 A	C10W32D040	C10W42D040
100 A	C10W32D100	C10W42D100

ComPacT NSX250HB2 (100 kA at 500 V - 100 kA at 690 V)

Rating	3P 3d	4P 3d, 4d, 3d + N/2
100 A	C25W32D100	C25W42D100
160 A	C25W32D160	C25W42D160
250 A	C25W32D250	C25W42D250

With electronic trip unit MicroLogic 5.2 E (LSI protection, energy meter)

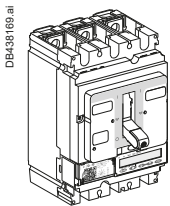

ComPacT NSX100HB2 (100 kA at 500 V - 100 kA at 690 V)

Rating	3P 3d	4P 3d, 4d, 3d + N/2, OSN
40 A	C10W35E040	C10W45E040
100 A	C10W35E100	C10W45E100

ComPacT NSX250HB2 (100 kA at 500 V - 100 kA at 690 V)

Rating	3P 3d	4P 3d, 4d, 3d + N/2, OSN
100 A	C25W35E100	C25W45E100
160 A	C25W35E160	C25W45E160
250 A	C25W35E250	C25W45E250

With electronic trip unit MicroLogic 6.2 E (LSIG protection, energy meter)

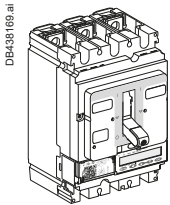

ComPacT NSX100HB2 (100 kA at 500 V - 100 kA at 690 V)

Rating	3P 3d	4P 3d, 4d, 3d + N/2, OSN
40 A	C10W36E040	C10W46E040
100 A	C10W36E100	C10W46E100

ComPacT NSX250HB2 (100 kA at 500 V - 100 kA at 690 V)

Rating	3P 3d	4P 3d, 4d, 3d + N/2, OSN
100 A	C25W36E100	C25W46E100
160 A	C25W36E160	C25W46E160
250 A	C25W36E250	C25W46E250

Complete Fixed Device

ComPacT NSX100/250HB2 (100 kA 500 V - 100 kA 690 V)

ComPacT NSX100/250HB2

With magnetic trip unit MA

DB438108.ai

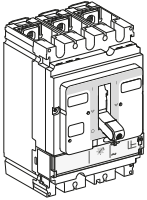

ComPacT NSX100HB2 (100 kA at 500 V - 100 kA at 690 V)

Rating	3P 3d
MA12.5	C10W3MA013
MA25	C10W3MA025
MA50	C10W3MA050
MA100	C10W3MA100

ComPacT NSX250HB2 (100 kA at 500 V - 100 kA at 690 V)

Rating	3P 3d
MA150	C25W3MA150
MA220	C25W3MA220

With electronic trip unit MicroLogic 2.2 M (LS_oI motor protection)

DB438106.ai

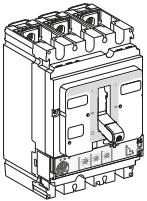

ComPacT NSX100HB2 (100 kA at 500 V - 100 kA at 690 V)

Rating	3P 3d
25 A	C10W32M025
50 A	C10W32M050
100 A	C10W32M100

ComPacT NSX250HB2 (100 kA at 500 V - 100 kA at 690 V)

Rating	3P 3d
150 A	C25W32M150
220 A	C25W32M220

With electronic trip unit MicroLogic 6.2 E-M (LSIG motor protection, energy meter)

DB438109.ai

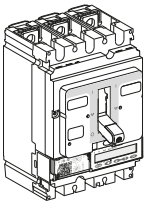

ComPacT NSX100HB2 (100 kA at 500 V - 100 kA at 690 V)

Rating	3P 3d
25 A	C10W36M025
50 A	C10W36M050
80 A	C10W36M080

ComPacT NSX250HB2 (100 kA at 500 V - 100 kA at 690 V)

Rating	3P 3d
150 A	C25W36M150
220 A	C25W36M220



Complete Fixed Device ComPacT NSX100/160/250NA

ComPacT NSX100/160/250NA Switch-Disconnectors

With NA switch-disconnector unit

DE438770.ai

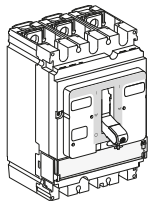

ComPacT NSX100NA

Rating	3P	4P
100 A	C103100S	C104100S

ComPacT NSX160NA

Rating	3P	4P
160 A	C163160S	C164160S

ComPacT NSX250NA

Rating	3P	4P
250 A	C253250S	C254250S

Based on Separate Components

ComPacT NSX100/160/250

Basic Frame

DB45871.ai

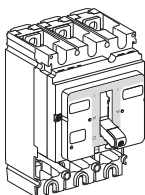

ComPacT NSX100

	3P	4P
NSX100B (25 kA 380/415 V)	C10B3	C10B4
NSX100F (36 kA 380/415 V)	C10F3	C10F4
NSX100N (50 kA 380/415 V)	C10N3	C10N4
NSX100H (70 kA 380/415 V)	C10H3	C10H4
NSX100S (100 kA 380/415 V)	C10S3	C10S4
NSX100L (150 kA 380/415 V)	C10L3	C10L4

ComPacT NSX160

	3P	4P
NSX160B (25 kA 380/415 V)	C16B3	C16B4
NSX160F (36 kA 380/415 V)	C16F3	C16F4
NSX160N (50 kA 380/415 V)	C16N3	C16N4
NSX160H (70 kA 380/415 V)	C16H3	C16H4
NSX160S (100 kA 380/415 V)	C16S3	C16S4
NSX160L (150 kA 380/415 V)	C16L3	C16L4

ComPacT NSX250

	3P	4P
NSX250B (25 kA 380/415 V)	C25B3	C25B4
NSX250F (36 kA 380/415 V)	C25F3	C25F4
NSX250N (50 kA 380/415 V)	C25N3	C25N4
NSX250H (70 kA 380/415 V)	C25H3	C25H4
NSX250S (100 kA 380/415 V)	C25S3	C25S4
NSX250L (150 kA 380/415 V)	C25L3	C25L4

+ Trip Unit

Distribution protection

DB112246.eps

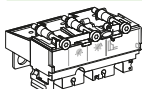

Thermal-magnetic TM-D

Rating	3P 3d	4P 3d	4P 4d
TM16D	C103TM016	C106TM016	C104TM016
TM25D	C103TM025	C106TM025	C104TM025
TM32D	C103TM032	C106TM032	C104TM032
TM40D	C103TM040	C106TM040	C104TM040
TM50D	C103TM050	C106TM050	C104TM050
TM63D	C103TM063	C106TM063	C104TM063
TM80D	C103TM080	C106TM080	C104TM080
TM100D	C103TM100	C106TM100	C104TM100
TM125D	C163TM125	C166TM125	C164TM125
TM160D ^[1]	C163TM160	C166TM160	C164TM160
TM160D ^[2]	C253TM160	C256TM160	C254TM160
TM200D	C253TM200	C256TM200	C254TM200
TM250D	C253TM250	C256TM250	C254TM250

MicroLogic 2.2 (LS₀I protection)

Rating	3P 3d	4P 3d, 4d, 3d + N/2
40 A	C1032D040	C1042D040
100 A	C1032D100	C1042D100
160 A	C1632D160	C1642D160
250 A	C2532D250	C2542D250

MicroLogic 5.2 E (LSI protection, energy meter)

Rating	3P 3d	4P 3d, 4d, 3d + N/2, 3d + OSN
40 A	C1035E040	C1045E040
100 A	C1035E100	C1045E100
160 A	C1635E160	C1645E160
250 A	C2535E250	C2545E250

MicroLogic 6.2 E (LSIG protection, energy meter)

Rating	3P 3d	4P 3d, 4d, 3d + N/2, 3d + OSN
40 A	C1036E040	C1046E040
100 A	C1036E100	C1046E100
160 A	C1636E160	C1646E160
250 A	C2536E250	C2546E250

[1] For NSX160.

[2] For NSX250.

DB112247.eps

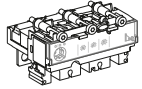

DB112248.eps

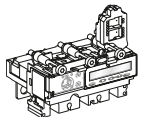

F

Based on Separate Components

ComPacT NSX100/160/250

+ Trip Unit (Cont.)

Distribution protection with embedded earth leakage protection

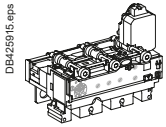

MicroLogic Vigi 4.2 (LS_oIR protection)

Rating	3P 3d	4P 4d 3d + N/2
40 A	C1034V040	C1044V040
100 A	C1034V100	C1044V100
160 A	C1634V160	C1644V160
250 A	C2534V250	C2544V250

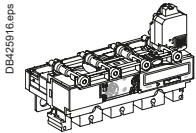

MicroLogic Vigi 7.2 E (LSIR protection)

Rating	3P 3d	4P 4d 3d + N/2
40 A	-	C1047E040
100 A	-	C1047E100
160 A	-	C1647E160
250 A	-	C2547E250

Distribution protection with embedded earth leakage alarm

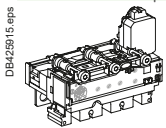

MicroLogic Vigi 4.2 AL (LS_oI protection + earth leakage alarm)

Rating	3P 3d	4P 4d 3d + N/2
40 A	C1034A040	C1044A040
100 A	C1034A100	C1044A100
160 A	C1634A160	C1644A160
250 A	C2534A250	C2544A250

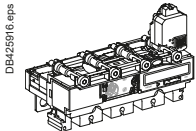

MicroLogic Vigi 7.2 E AL (LSI protection + earth leakage alarm)

Rating	3P 3d	4P 4d 3d + N/2
40 A	-	C1047A040
100 A	-	C1047A100
160 A	-	C1647A160
250 A	-	C2547A250

Motor protection

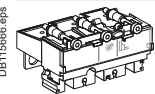

Magnetic MA (I protection)

Rating	3P 3d	4P 3d
MA2.5	C103MA003	
MA6.3	C103MA007	
MA12.5	C103MA013	
MA25	C103MA025	
MA50	C103MA050	
MA100	C103MA100	C106MA100
MA150	C163MA150	C166MA150
MA220	C253MA220	C256MA220

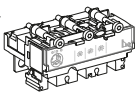

MicroLogic 2.2 M (LS_oI protection)

Rating	3P 3d
25 A	C1032M025
50 A	C1032M050
100 A	C1032M100
150 A	C1632M150
220 A	C2532M220

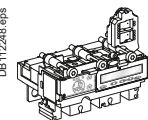

MicroLogic 6.2 E-M (LSIG protection, energy meter)

Rating	3P 3d
25 A	C1036M025
50 A	C1036M050
80 A	C1036M080
150 A	C1636M150
220 A	C2536M220

Generator protection

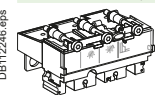

Thermal-magnetic TM-G

Rating	3P 3d	4P 4d
TM16G	C103MG016	C104MG016
TM25G	C103MG025	C104MG025
TM40G	C103MG040	C104MG040
TM63G	C103MG063	C104MG063
TM80G	C103MG080	C104MG080
TM100G	C103MG100	C104MG100
TM125G	C163MG125	C164MG125
TM160G	C163MG160	C164MG160
TM200G	C253MG200	C254MG200
TM250G	C253MG250	C254MG250

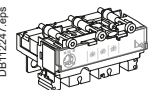

MicroLogic 2.2 G (LS_oI protection)

Rating	3P 3d	4P 3d, 4d, 3d + N/2
40 A	C1032G040	C1042G040
100 A	C1032G100	C1042G100
160 A	C1632G160	C1642G160
250 A	C2532G250	C2542G250

F

Based on Separate Components

ComPacT NSX100/160/250

+ Trip Unit (Cont.)

Protection of public distribution systems

DB112247.eps

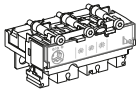

MicroLogic 2.2 AB (LS₀I protection)

Rating	4P 3d, 4d, 3d + N/2
100 A	C1042B100
160 A	C1642B160
240 A	C2542B240

Earth Leakage protection of public distribution systems

MicroLogic Vigi 4.2 AB distribution protections

Rating	4P 3d, 4d, 3d + N/2
100 A	C1044B100
160 A	C1644B160
250 A	C2544B250

16 Hz 2/3 network protection

DB112248.eps

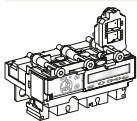

MicroLogic 5.2 A-Z (LSI protection)

Rating	3P 3d
100 A	C1035Z100
250 A	C2535Z250

+ VigiPacT add-on Protection and Alarm Modules

VigiPacT add-on protection

DB112249.eps

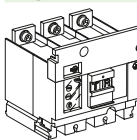

	3P	4P
NSX100/160 (200 to 440 V)	LV429488	LV429489
NSX250 (200 to 440 V)	LV429492	LV429493
NSX100/160 (440 to 550 V)	LV429490	LV429491
NSX250 (440 to 550 V)	LV429494	LV429495
Connection for a 4P VigiPacT on a 3P breaker		LV429214

VigiPacT add-on alarm

DB112246.eps

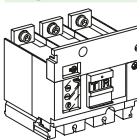



	3P	4P
200 to 440 V AC	LV429498	LV429499
Connection for a 4P insulation monitoring module on a 3P breaker		LV429214



Trip Unit Accessories

ComPacT NSX100/160/250

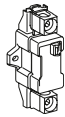
Trip Unit Accessories

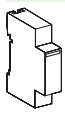
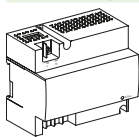
External neutral CT for 3 pole breaker with MicroLogic 5/6		
 DB112733.eps	25-100 A	LV429521
	150-250 A	LV430563
24 V DC wiring accessory for MicroLogic 5/6		
 DB112730.eps	24 V DC power supply connector	LV434210
ZSI wiring accessory for NS630b NW with NSX		
 DB115865.eps	ZSI module	LV434212
External power supply module (24 V DC - 1 A), class 4		
 DB432608.eps	24-30 V DC	LV454440
	48-60 V DC	LV454441
	100-125 V DC	LV454442
	110-130 V AC	LV454443
	200-240 V AC	LV454444

Fixed/RC Device = Fixed/FC Device + Rear Connection Kit

DB438172.ai

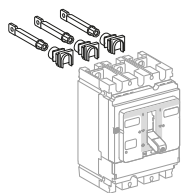

Short RC kit			
Kit 3P		3 x	LV429235
Kit 4P		4 x	LV429235
Mixed RC kit			
Kit 3P	Short RCs	2 x	LV429235
	Long RCs	1 x	LV429236
Kit 4P	Short RCs	2 x	LV429235
	Long RCs	2 x	LV429236

Plug-in Version = Fixed/FC Device + Plug-in Kit

Kit for ComPacT NSX

DB438173.ai

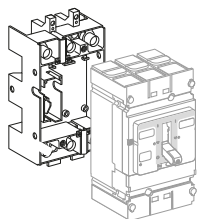

Plug-in kit	3P	4P
Comprising:	LV429289	LV429290
Base	= 1 x LV429266	= 1 x LV429267
Power connections	+ 3 x LV429268	+ 4 x LV429268
Short terminal shields	+ 2 x LV429515	+ 2 x LV429516
Safety trip interlock	+ 1 x LV429270	+ 1 x LV429270

Withdrawable Version = Fixed/FC Device + Withdrawable Kit

Kit for ComPacT NSX

DB438174.ai

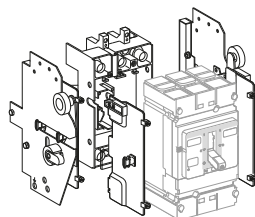

	3P	4P
	Kit for ComPacT NSX	Kit for ComPacT NSX
	=	=
Plug-in kit	1 x LV429289	1 x LV429290
	+	+
Chassis side plates for base	1 x LV429282	1 x LV429282
	+	+
Chassis side plates for breaker	1 x LV429283	1 x LV429283



Accessories and Auxiliaries

ComPacT NSX100/160/250

Connection Accessories (Cu or Al)

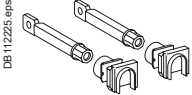
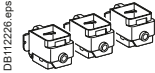
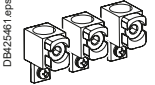
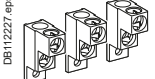
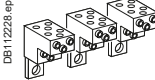
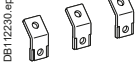
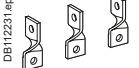
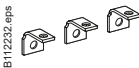
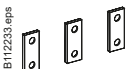
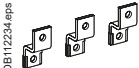
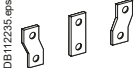
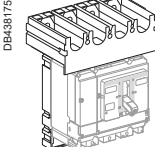
Rear connections					
	2 short		LV429235		
	2 long		LV429236		
Bare cable connectors					
	Steel connectors	1 x (1.5 to 95 mm ²) ; ≤ 160 A	Set of 2 Set of 3 Set of 4	LV429246 LV429242 LV429243	
		Aluminium connectors	1 x (25 to 95 mm ²) ; ≤ 250 A	Set of 2 Set of 3 Set of 4	LV429255 LV429227 LV429228
			1 x (120 to 185 mm ²) ; ≤ 250 A	Set of 2 Set of 3 Set of 4	LV429247 LV429259 LV429260
1 x (120 to 240 mm ²) ; ≤ 250 A	Set of 3 Set of 4		LV429244 LV429245		
	Clips for connectors		Set of 10	LV429241	
		Aluminium connectors for 2 cables ^[1]	2 x (50 to 120 mm ²) ; ≤ 250 A	Set of 3 Set of 4	LV429218 LV429219
	Aluminium connectors ^[1] for 6 cables	6 x (1.5 to 35 mm ²) ; ≤ 250 A	Set of 3 Set of 4	LV429248 LV429249	
		6.35 mm voltage tap for aluminium connectors for 1 or 2 cables	Set of 10	LV429348	
	Linerage DX and Linerage DP distribution block (for bare cable)	160 A (40 °C) 6 cables S ≤ 10 mm ²	1P	04031	
		250 A (40 °C) 9 cables S ≤ 10 mm ²	3P	04033	
			4P	04034	
Terminal extensions					
	45° terminal extension ^[1]		Set of 3 Set of 4	LV429223 LV429224	
		Edgewise terminal extensions ^[1]	Set of 3 Set of 4	LV429308 LV429309	
	Right-angle terminal extensions ^[1]		Set of 3 Set of 4	LV429261 LV429262	
		Straight terminal extensions ^[1]	Set of 3 Set of 4	LV429263 LV429264	
	Double-L terminal extensions ^[1]		Set of 3 Set of 4	LV429221 LV429222	
		Spreaders from 35 to 45 mm pitch ^[1]	3P 4P	LV431563 LV431564	
	One-piece spreader from 35 to 45 mm pitch		3P 4P	LV431060 LV431061	
					
					
					

[1] Supplied with 2 or 3 interphase barriers.

Accessories and Auxiliaries

ComPacT NSX100/160/250

Crimp lugs for copper cable^[1]

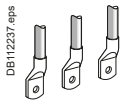

For cable 120 mm ²	Set of 3	LV429252
	Set of 4	LV429256
For cable 150 mm ²	Set of 3	LV429253
	Set of 4	LV429257
For cable 185 mm ²	Set of 3	LV429254
	Set of 4	LV429258

Crimp lugs for aluminium cable^[1]

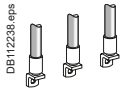

For cable 150 mm ²	Set of 3	LV429504
	Set of 4	LV429505
For cable 185 mm ²	Set of 3	LV429506
	Set of 4	LV429507

Insulation accessories

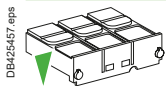

1 short terminal shield for breaker or plug-in base	3P	LV429515
	4P	LV429516

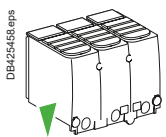

1 long terminal shield for breaker or plug-in base	3P	LV429517
	4P	LV429518

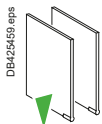

Interphase barriers for breaker or plug-in base	Set of 6	LV429329
---	----------	----------

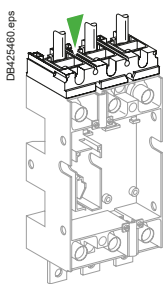

Connection adapter for plug-in base	3P	LV429306
	4P	LV429307

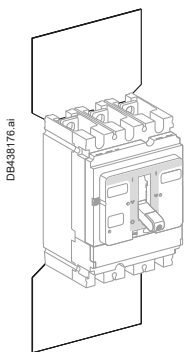

2 insulating screens for breaker (45 mm pitch)	3P	LV429330
	4P	LV429331

[1] Supplied with 2 or 3 interphase barriers.



Accessories and Auxiliaries

ComPacT NSX100/160/250

Electrical Auxiliaries

Auxiliary contacts (wired, screwless)

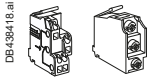

OF or SD or SDE or SDV screwless type	29450
OF or SD or SDE or SDV low level screw type	29452
SDE adapter, mandatory for trip unit TM, MA or MicroLogic 2	LV429451

Auxiliary contacts (wireless)



OF or SD or SDE wireless	LV429454
--------------------------	-----------------

SDx output module for MicroLogic

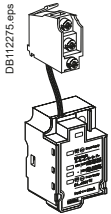

SDx module 24/415 V AC/DC screw type	LV429532
--------------------------------------	-----------------

SDTAM contactor tripping module (early-break thermal fault signal) for MicroLogic 2.2 M/6.2 E-M

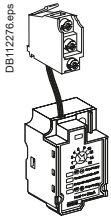

SDTAM 24/415 V AC/DC overload fault indication	LV429424
--	-----------------

Voltage releases

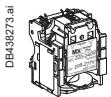

	Voltage	MX	MN
AC	24 V 50/60 Hz	LV429384	LV429404
	48 V 50/60 Hz	LV429385	LV429405
	110-130 V 50/60 Hz	LV429386	LV429406
	220-240 V 50/60 Hz and 208-277 V 60 Hz	LV429387	LV429407
	380-415 V 50 Hz and 440-480 V 60 Hz	LV429388	LV429408
	525 V 50 Hz and 600 V 60 Hz	LV429389	LV429409
DC	12 V	LV429382	LV429402
	24 V	LV429390	LV429410
	30 V	LV429391	LV429411
	48 V	LV429392	LV429412
	60 V	LV429383	LV429403
	125 V	LV429393	LV429413
	250 V	LV429394	LV429414

MN 48 V 50/60 Hz with fixed time delay

Composed of:	MN 48 V DC	LV429412
	Delay unit 48 V 50/60 Hz	LV429426

MN 220-240 V 50/60 Hz with fixed time delay

Composed of:	MN 250 V DC	LV429414
	Delay unit 220-240 V 50/60 Hz	LV429427

MN 48 V DC/AC 50/60 Hz with adjustable time delay

Composed of:	MN 48 V DC	LV429412
	Delay unit 48 V DC/AC 50/60 Hz	33680

MN 110-130 V DC/AC 50/60 Hz with adjustable time delay

Composed of:	MN 125 V DC	LV429413
	Delay unit 100-130 V DC/AC 50/60 Hz	33681

MN 220-250 V DC/AC 50/60 Hz with adjustable time delay

Composed of:	MN 250 V DC	LV429414
	Delay unit 200-250 V DC/AC 50-60 Hz	33682

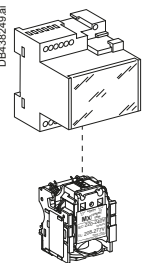

F

Motor Mechanism

Motor mechanism module supplied with SDE adapter

DB112554 eps

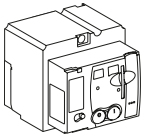

	Voltage	MT100/160	MT250
AC	48-60 V 50/60 Hz	LV429440	LV431548
	110-130 V 50/60 Hz	LV429433	LV431540
	220-240 V 50/60 Hz and 208-277 V 60 Hz	LV429434	LV431541
	380-415 V 50/60 Hz and 440-480 V 60 Hz	LV429435	LV431542
	DC		
DC	24-30 V	LV429436	LV431543
	48-60 V	LV429437	LV431544
	110-130 V	LV429438	LV431545
	250 V	LV429439	LV431546

Communicating motor mechanism module supplied with SDE adapter

DB112285 eps

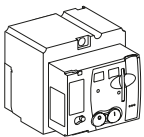

Motor mechanism module	MTc 100/160	220-240 V 50/60 Hz	LV429441
	MTc 250	220-240 V 50/60 Hz	LV431549

+

Breaker and Status
 Communication Module

BSCM	LV434205
------	-----------------

+

NSX cord

Wire length L = 0.35 m	LV434200
Wire length L = 1.3 m	LV434201
Wire length L = 3 m	LV434202
U > 480 V AC wire length L = 0.35 m	LV434204



Accessories and Auxiliaries

ComPacT NSX100/160/250

Indication and Measurement Modules

PowerLogic PowerTag NSX

	Rating (A)			250
	3P			LV434020
	3P+N			LV434021

Current transformer module

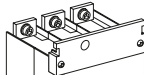
	Rating (A)	100	150	250
	3P	LV429457	LV430557	LV431567
	4P	LV429458	LV430558	LV431568

Current transformer module and voltage output

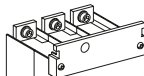
	Rating (A)	125	150	250
	3P	LV429461	LV430561	LV431569
	4P	LV429462	LV430562	LV431570

Rotary Handles

Direct rotary handle

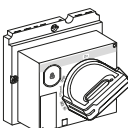
	With black handle	LV429337T
	With red handle on yellow front	LV429339T
	MCC conversion accessory	LV429341T
	CNOMO conversion accessory	LV429342T

Extended rotary handle

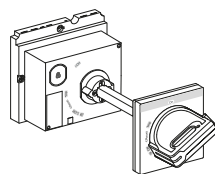
	With black handle	LV429338T
	With red handle on yellow front	LV429340T
	With telescopic handle for withdrawable device	LV429343T

Open door shaft operator	LV426937
--------------------------	-----------------

Accessories for direct or extended rotary handle

Indication auxiliary	1 early-break contact	LV429345
	2 early-make contacts	LV429346

F

Locks

Toggle locking device for 1 to 3 padlocks

DB438179.ai	By removable device	29370
-------------	---------------------	--------------

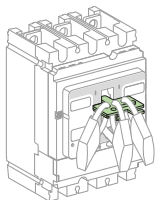

DB438180.ai	By fixed device for 3P-4P (open or close position)	LV429371
	By fixed device for 3P-4P (open position only)	LV429370

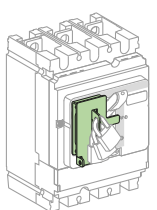

Locking of rotary handle

DB438181.ai	Keylock adapter (keylock not included)	LV429344
	Keylock (keylock adapter not included)	41940
	Profalux KS5 B24 D4Z	42888

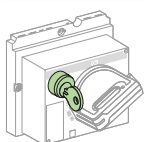

Locking of motor mechanism module

DB424605.eps	Keylock adapter + Ronis keylock (special)	LV429449
--------------	---	-----------------

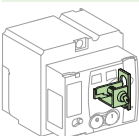

Accessories and Auxiliaries

ComPacT NSX100/160/250

Interlocking

Mechanical interlocking for circuit breakers

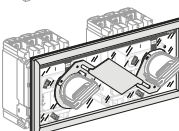

 <p>DB438182.ai</p>	With toggles	LV429354T
	With direct rotary handle	LV429369T
 <p>DB438183.ai</p>	With extended rotary handle	LV429369ET

Interlocking with key (2 keylocks/1 key) for rotary handles

 <p>DB438184.ai</p>	Keylock kit (keylock not included) ^[1]	LV429344	
	1 set of 2 keylocks	Ronis 1351B.500	41950
	(1 key only, keylock kit not included)	Profalux KS5 B24 D4Z	42878

Installation Accessories

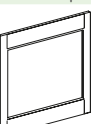
Front-panel escutcheons

 <p>DB112269.eps</p> <p>IP30</p>	IP30 escutcheon for all control types	LV429525
	IP30 trip unit access escutcheon for toggle	LV429526
	IP30 escutcheon for VigiPacT add-on	LV429527
 <p>DB112737.eps</p> <p>IP40</p>	IP40 escutcheon for all control types	LV429317
	IP40 escutcheon for VigiPacT add-on	LV429316
	IP40 escutcheon for VigiPacT add-on or ammeter module	LV429318

IP43 rubber toggle cover

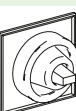
 <p>DB112738.eps</p>	1 toggle cover	LV429319 ^[2]
---	----------------	-------------------------

Lead-sealing accessories

 <p>DB115615.eps</p>	Bag of accessories	LV429375
---	--------------------	----------

Din rail adapter

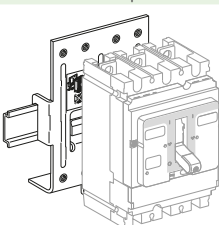
 <p>DB438185.ai</p>	1 adapter	LV429305
--	-----------	----------



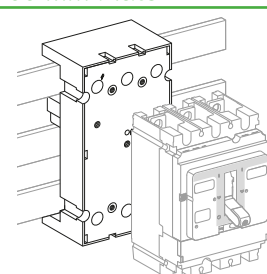







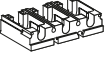

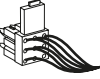
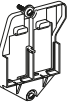
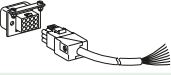
60 Mm Plate

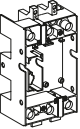
 <p>DB438186.ai</p>	Plate 3P ComPacT NSX100/250 IEC	LV429372
	Plate 4P ComPacT NSX100/250 IEC	LV429373

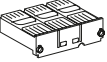
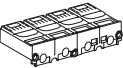
[1] For only 1 device.

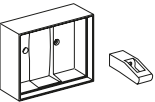
[2] Applicable with old front cover only. Need to order LV429313, toggle extension to be compatible for IP43 rubber cover.

Plug-in/Withdrawable Version Accessories

Insulation accessories			
DB117159.eps 	1 connection adapter for plug-in base	3P	LV429306
		4P	LV429307
Auxiliary connections			
DB117160.eps 	1 9-wire fixed connector (for base)		LV429273
	DB117161.eps 	1 9-wire moving connector (for circuit breaker)	
1 support for 2 moving connectors			LV429275
DB117162.eps 			LV429275
DB115935.eps 	9-wire manual auxiliary connector (fixed + moving)		LV429272
Plug-in base accessories			
DB432605.eps 	2 long insulated right angle terminal extensions	Set of 2	LV429276
DB117165.eps 	2 IP40 shutters for base		LV429271
DB117166.eps 	Base	2P (3P base)	LV429265
		3P	LV429266
DB117167.eps 	Base	4P	LV429267
DB117168.eps 	2 power connections	2/3/4P	LV429268
DB117169.eps 	1 short terminal shield	2/3P	LV429515
DB117170.eps 	1 short terminal shield	4P	LV429516
DB117171.eps 	1 safety trip interlock	2/3/4P	LV429270
Chassis accessories			
DB117172.eps 	Escutcheon collar	Toggle	LV429284 ^[1]
DB117173.eps 	Escutcheon collar	VigiPacT add-on	LV429285
DB117163.eps 	Locking kit (keylock not included)		LV429286
DB11426.eps 	Keylock (keylock adapter not included)	Ronis 1351B.500	41940
		Profalux KS5 B24 D4Z	42888
	2 carriage switches (connected/disconnected position indication)		LV429287

[1] Need to order LV434435, NSX front cover to be compatible for escutcheon collar for toggle.

Accessories and Auxiliaries

ComPacT NSX100/160/250



Spare Parts

DB111430.eps	5 spare toggle extensions (NSX250)		LV429313
DB115620.eps	Bag of screws		LV429312
DB111431.eps	12 snap-in nuts (fixed/FC)	M6 for NSX100N/H/L M8 for NSX160/250N/H/L	LV429234 LV430554
DB438167.ai	NSX100-250 front cover	3P/4P	LV434435
	Retrofit NSX100-250 front cover	3P/4P	LV43435AT
DB111433.eps	IP40 toggle escutcheon	ComPacT NS type/small cut-out	29315
DB111438.eps	1 set of 10 identification labels		LV429226
DB438168.ai	1 base for extended rotary handle		LV429502
DB111434.eps	Torque limiting screws (set of 12)	3P/4P ComPacT NSX100-250	LV429513
DB111435.eps	LCD display for electronic trip unit	MicroLogic 5 MicroLogic 6 MicroLogic 6 E-M	LV429483 LV429484 LV429486
DB111436.eps	5 transparent covers for trip unit	TM, MA, NA MicroLogic 2 MicroLogic 5/6	LV429481 LV429481 LV429478

Visible Break Disconnect Function

See catalog dealing with "ComPacT INV products (visible break)" and the associated accessories.
The visible break disconnection function is compatible with fixed front-connected/rear-connected ComPacT NSX devices.

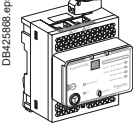
Communication Option

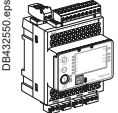
	IFE	Ethernet interface for LV breaker	LV434001
		Ethernet interface for LV breakers and gateway	LV434002
		IFM Modbus-SL interface module	LV434000
		I/O application module	LV434063

Monitoring and Control (Remote Operation)

Circuit breaker accessories

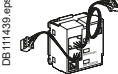
	Breaker Status Control Module	BSCM ^[1]	LV434205
---	-------------------------------	---------------------	----------



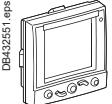



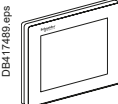

ULP display module ^[2]

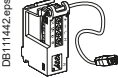
	Switchboard front display module FDM121	TRV00121
	FDM mounting accessory (diameter 22 mm)	TRV00128

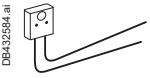
Ethernet display module

	Switchboard front display module FDM128	LV434128
---	---	----------

ULP wiring accessories

	NSX cord L = 0.35 m	LV434200
	NSX cord L = 1.3 m	LV434201
	NSX cord L = 3 m	LV434202
	NSX cord for U > 480 V AC L = 1.3 m	LV434204
	10 stacking connectors for communication interface modules	TRV00217
	2 Modbus line terminators	VW3A8306DRC ^[3]
	Connector Modbus adaptor	LV434211
	RS 485 roll cable (4 wires, length 60 m)	50965
	5 RJ45 connectors female/female	TRV00870
	10 ULP line terminators	TRV00880
	10 RJ45/RJ45 male cord L = 0.3 m	TRV00803
	10 RJ45/RJ45 male cord L = 0.6 m	TRV00806
	5 RJ45/RJ45 male cord L = 1 m	TRV00810
	5 RJ45/RJ45 male cord L = 2 m	TRV00820
	5 RJ45/RJ45 male cord L = 3 m	TRV00830
	1 RJ45/RJ45 male cord L = 5 m	TRV00850

[1] SDE adapter mandatory for trip unit TM, MA or MicroLogic 2 (LV429451).

[2] For measurement display with MicroLogic E or status display with BSCM.



[3] www.schneider-electric.com.



Accessories and Auxiliaries

ComPacT NSX100/160/250

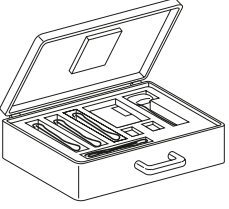
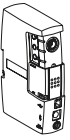
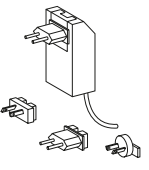
Test Tool, Software, Demo

Test tool	
 <p>DB111449.eps</p>	<p>Pocket battery for MicroLogic NSX100-630 LV434206</p>
 <p>DB111451.eps</p>	<p>Maintenance case TRV00910 Comprising: - USB maintenance interface - Power supply - MicroLogic cord - USB cord - RJ45/RJ45 male cord</p>
 <p>DB111450.eps</p>	<p>Spare USB maintenance interface TRV00911</p>
 <p>DB111452.eps</p>	<p>Spare power supply 110-240 V AC TRV00915</p>
 <p>DB111453.eps</p>	<p>Spare MicroLogic cord for USB maintenance interface TRV00917</p>
 <p>DB111448.eps</p>	<p>Bluetooth/Modbus option for USB maintenance interface VW3A8114 ^[1]</p>

[1] See Telemecanique catalog.

Accessories

Power supply modules

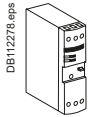

External power supply module 100-240 V AC 110-230 V DC/24 V DC-3 A class 2 | **ABL8RPS24030** [1]

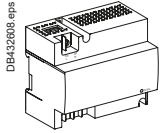

External power supply module 24 V DC-1 A OVC IV	
24-30 V DC	LV454440
48-60 V DC	LV454441
100-125 V DC	LV454442
110-130 V AC	LV454443
200-240 V AC	LV454444

[1] See Telemecanique catalog.





F

Catalog Numbers: ComPacT NSX400-630

Complete Fixed Device F-50
Com**PacT** NSX400/630F (36 KA 380/415 V) F-50
Com**PacT** NSX400/630N (50 KA 380/415 V)..... F-51
Com**PacT** NSX400/630H (70 KA 380/415 V)..... F-52
Com**PacT** NSX400/630R (200 KA 380/415 V - 45 KA 690 V) F-53
Com**PacT** NSX400/630HB1 (85 KA 500 V - 75 KA 690 V)..... F-54
Com**PacT** NSX400/630HB2 (85 KA 500 V - 100 KA 690 V)..... F-55
Com**PacT** NSX400/630NA
Com**PacT** NSX400K (10 KA - 1000V AC)..... F-56

Based on Separate Components F-57
Com**PacT** NSX400/630 F-57

Trip Unit Accessories F-59
Com**PacT** NSX400/630 F-59

Installation and Connection..... F-60
Com**PacT** NSX400/630 F-60

Communication, Monitoring and Control..... F-70
Com**PacT** NSX400/630 F-70

Monitoring and Control, Accessories F-71
Com**PacT** NSX400/630 F-71

Source-Changeover Systems for 2 Devices..... F-72
Com**PacT** NSX100 to NSX630 F-72

ComPacT NSX100 to NSX630 Order Form F-74



Other Chapters

Select Circuit Breakers and Switch-Disconnectors A-1
Select Protection B-1
Customize Circuit Breakers with Accessories..... C-1
Smart Panel Integration D-1
Switchboard Integration..... E-1
Glossary G-1
Additional Characteristics..... H-1

Complete Fixed Device

ComPacT NSX400/630F (36 KA 380/415 V)

ComPacT NSX400/630F

Electronic trip unit MicroLogic 2.3 (LS₀I protection)

DB438189.ai

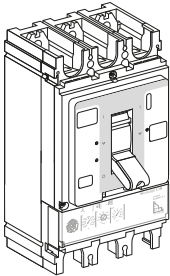

		3P 3d	4P 3d, 4d, 3d + N/2
ComPacT NSX400F (36 kA at 380/415 V)	250 A	C40F32D250	C40F42D250
	400 A	C40F32D400	C40F42D400
ComPacT NSX630F (36 kA at 380/415 V)	630 A	C63F32D630	C63F42D630

Electronic trip unit MicroLogic Vigi 4.3 (LS₀IR protection)

DB438190.ai

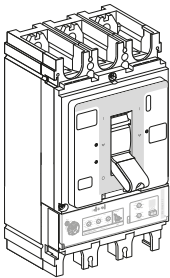

		3P 3d	4P 4d 3d + N/2
ComPacT NSX400F (36 kA at 380/415 V)	400 A	C40F34V400	C40F44V400
	570 A	C63F34V570	C63F44V570

Electronic trip unit MicroLogic 1.3 M (I motor protection)

DB438191.ai

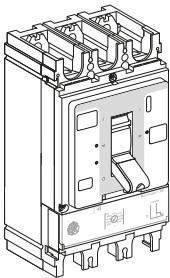

		3P 3d
ComPacT NSX400F 1.3 M (36 kA at 380/415V)	320 A	C40F31M320
	500 A	C63F31M500

Electronic trip unit MicroLogic 2.3 M (LS₀I motor protection)

DB438192.ai

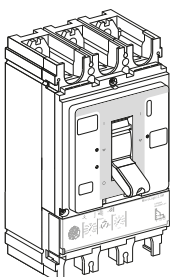

		3P 3d
ComPacT NSX400F 2.3 M (36 kA at 380/415V)	320 A	C40F32M320
	500 A	C63F32M500

With electronic trip unit MicroLogic 5.3 E (LSI protection, energy meter)

Only available as separate component or through online configurator (product selector)

With electronic trip unit MicroLogic 6.3 E (LSIG protection, energy meter)

Only available as separate component or through online configurator (product selector)

With electronic trip unit MicroLogic 6.3 E-M (LSIG motor protection, energy meter)

Only available as separate component or through online configurator (product selector)

With electronic trip unit MicroLogic 7.3 E (LSIG protection, energy meter)

Only available as separate component or through online configurator (product selector)

F

Complete Fixed Device

ComPacT NSX400/630N (50 KA 380/415 V)

ComPacT NSX400/630N

Electronic trip unit MicroLogic 2.3 (LS₀I protection)

DB438199.ai

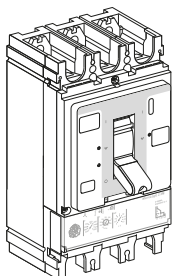

ComPacT NSX400N (50 kA at 380/415 V)	250 A	3P 3d C40N32D250	4P 3d, 4d, 3d + N/2 C40N42D250
	400 A	C40N32D400	C40N42D400
ComPacT NSX630N (50 kA at 380/415 V)	630 A	C63N32D630	C63N42D630

Electronic trip unit MicroLogic Vigi 4.3 (LS₀IR protection)

DB438190.ai

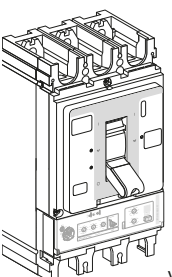

ComPacT NSX400N (50 kA at 380/415 V)	400 A	3P 3d C40N34V400	4P 4d 3d + N/2 C40N44V400
ComPacT NSX630N (50 kA at 380/415 V)	570 A	C63N34V570	C63N44V570

Electronic trip unit MicroLogic 1.3 M A (I motor protection)

DB438191.ai

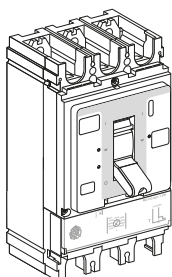

ComPacT NSX400N 1.3 M (50 kA at 380/415V)	320 A	3P 3d C40N31M320	
ComPacT NSX630N 1.3 M (50 kA at 380/415V)	500 A	C63N31M500	

Electronic trip unit MicroLogic 2.3 M (LS₀I motor protection)

DB438192.ai

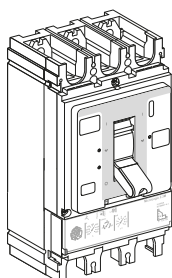

ComPacT NSX400N 2.3 M (50 kA at 380/415V)	320 A	3P 3d C40N32M320	
ComPacT NSX630N 2.3 M (50 kA at 380/415V)	500 A	C63N32M500	



Complete Fixed Device

ComPacT NSX400/630H (70 KA 380/415 V)

ComPacT NSX400/630H

Electronic trip unit MicroLogic 2.3 (LS_oI protection)

DB438109.ai

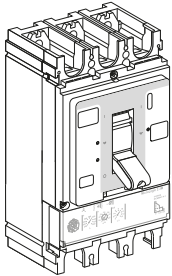

		3P 3d	4P 3d, 4d, 3d + N/2
ComPacT NSX400H (70 kA at 380/415 V)	250 A	C40H32D250	C40H42D250
	400 A	C40H32D400	C40H42D400
ComPacT NSX630H (70 kA at 380/415 V)	630 A	C63H32D630	C63H42D630

Electronic trip unit MicroLogic Vigi 4.3 (LS_oIR protection)

DB438190.ai

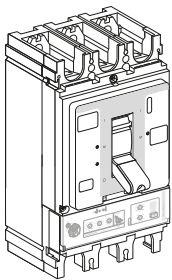

		3P 3d	4P 4d 3d + N/2
ComPacT NSX400H (70 kA at 380/415 V)	400 A	C40H34V400	C40H44V400
ComPacT NSX630H (70 kA at 380/415 V)	570 A	C63H34V570	C63H44V570

Electronic trip unit MicroLogic 1.3 M (I motor protection)

DB438191.ai

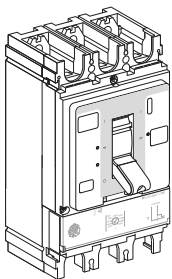

		3P 3d
ComPacT NSX400H 1.3 M (70 kA at 380/415V)	320 A	C40H31M320
ComPacT NSX630H 1.3 M (70 kA at 380/415V)	500 A	C63H31M500

Electronic trip unit MicroLogic 2.3 M (LS_oI motor protection)

DB438192.ai

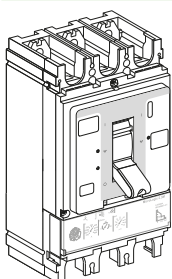

		3P 3d
ComPacT NSX400H 2.3 M (70 kA at 380/415V)	320 A	C40H32M320
ComPacT NSX630H 2.3 M (70 kA at 380/415V)	500 A	C63H32M500

With electronic trip unit MicroLogic 6.3 E (LSIG protection, energy meter)

Only available as separate component or through online configurator (product selector)

With electronic trip unit MicroLogic 6.3 E-M (LSIG motor protection, energy meter)

Only available as separate component or through online configurator (product selector)

With electronic trip unit MicroLogic 7.3 E (LSIG protection, energy meter)

Only available as separate component or through online configurator (product selector)

Complete Fixed Device

ComPacT NSX400/630R (200 kA 380/415 V - 45 kA 690 V)

ComPacT NSX400/630R

Electronic trip unit MicroLogic 2.3 (LS₀I protection)

DB438109.ai

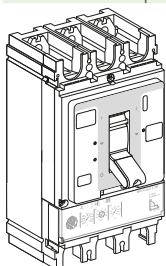

NSX400R (200 kA at 380/415 V - 45 kA at 690 V)	250 A	3P 3d	4P 3d, 4d, 3d + N/2
	400 A	C40R32D250	C40R42D250
NSX630R (200 kA at 380/415 V - 45 kA at 690 V)	630 A	C40R32D400	C40R42D400
		C63R32D630	C63R42D630

Electronic trip unit MicroLogic 5.3 E (LSI protection, energy meter)

DB438109.ai

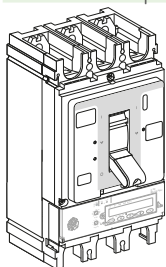

NSX400R (200 kA at 380/415 V - 45 kA at 690 V)	400 A	3P 3d	4P 3d, 4d, 3d + N/2, 3d + OSN
		C40R35E400	C40R45E400
NSX630R (200 kA at 380/415 V - 45 kA at 690 V)	630 A	C63R35E630	C63R45E630

Electronic trip unit MicroLogic 6.3 E (LSIG protection, energy meter)

DB438109.ai

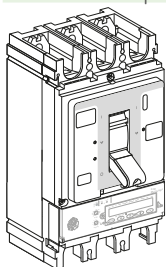

NSX400R (200 kA at 380/415 V - 45 kA at 690 V)	400 A	3P 3d	4P 3d, 4d, 3d + N/2, 3d + OSN
		C40R36E400	C40R46E400
NSX630R (200 kA at 380/415 V - 45 kA at 690 V)	630 A	C63R36E630	C63R46E630

Electronic trip unit MicroLogic 1.3 M (I motor protection)

DB438109.ai

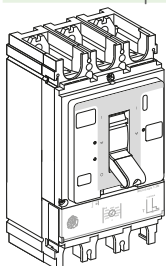

NSX400R (200 kA at 380/415 V - 45 kA at 690 V)	320 A	3P 3d	
		C40R31M320	
NSX630R (200 kA at 380/415 V - 45 kA at 690 V)	500 A	C63R31M500	

Electronic trip unit MicroLogic 2.3 M (LS₀I motor protection)

DB438109.ai

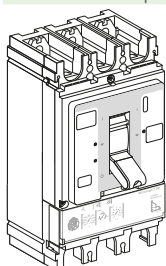

NSX400R (200 kA at 380/415 V - 45 kA at 690 V)	320 A	3P 3d	
		C40R32M320	
NSX630R (200 kA at 380/415 V - 45 kA at 690 V)	500 A	C63R32M500	

With electronic trip unit MicroLogic 6.3 E-M (LSIG motor protection, energy meter)

DB438109.ai

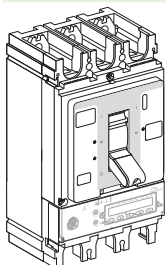

NSX400R (200 kA at 380/415 V - 45 kA at 690 V)	320 A	3P 3d	
		C40R36M320	
NSX630R (200 kA at 380/415 V - 45 kA at 690 V)	500 A	C63R36M500	

F

Complete Fixed Device

ComPacT NSX400/630HB1 (85 KA 500 V - 75 KA 690 V)

ComPacT NSX400/630HB1

Electronic trip unit MicroLogic 2.3 (LS₀I protection)

DB438189.ai

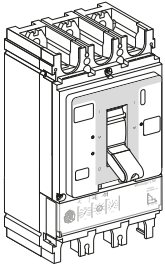

NSX400HB1 (85 kA at 500 V - 75 kA at 690 V)	250 A	3P 3d	4P 3d, 4d, 3d + N/2
	400 A	C40V32D250	C40V42D250
		C40V32D400	C40V42D400
NSX630HB1 (85 kA at 500 V - 75 kA at 690 V)	630 A	C63V32D630	C63V42D630

Electronic trip unit MicroLogic 5.3 E (LSI protection, energy meter)

DB438193.ai

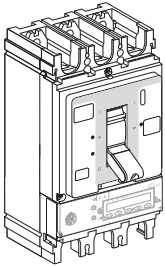

NSX400HB1 (85 kA at 500 V - 75 kA at 690 V)	400 A	3P 3d	4P 3d, 4d, 3d + N/2, 3d + OSN
		C40V35E400	C40V45E400
NSX630HB1 (85 kA at 500 V - 75 kA at 690 V)	630 A	C63V35E630	C63V45E630

Electronic trip unit MicroLogic 6.3 E (LSIG protection, energy meter)

DB438194.ai

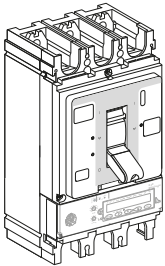

NSX400HB1 (85 kA at 500 V - 75 kA at 690 V)	400 A	3P 3d	4P 3d, 4d, 3d + N/2, 3d + OSN
		C40V36E400	C40V46E400
NSX630HB1 (85 kA at 500 V - 75 kA at 690 V)	630 A	C63V36E630	C63V46E630

Electronic trip unit MicroLogic 1.3 M (I motor protection)

DB438191.ai

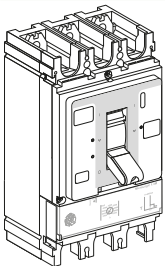

NSX400HB1 (85 kA at 500 V - 75 kA at 690 V)	320 A	3P 3d	
		C40V31M320	
NSX630HB1 (85 kA at 500 V - 75 kA at 690 V)	500 A	C63V31M500	

Electronic trip unit MicroLogic 2.3 M (LS₀I motor protection)

DB438192.ai

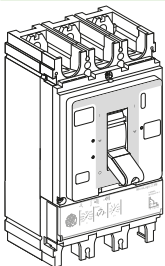

NSX400HB1 (85 kA at 500 V - 75 kA at 690 V)	320 A	3P 3d	
		C40V32M320	
NSX630HB1 (85 kA at 500 V - 75 kA at 690 V)	500 A	C63V32M500	

With electronic trip unit MicroLogic 6.3 E-M (LSIG motor protection, energy meter)

DB438195.ai

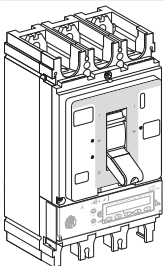

NSX400HB1 (85 kA at 500 V - 75 kA at 690 V)	320 A	3P 3d	
		C40V36M320	
NSX630HB1 (85 kA at 500 V - 75 kA at 690 V)	500 A	C63V36M500	

F

Complete Fixed Device

ComPacT NSX400/630HB2 (85 KA 500 V - 100 KA 690 V)

ComPacT NSX400/630HB2

Electronic trip unit MicroLogic 2.3 (LS₀I protection)

DB438109.ai

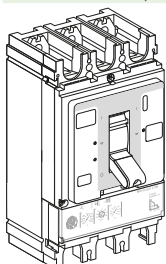

NSX400HB2 (85 kA at 500 V - 100 kA at 690 V)	250 A	3P 3d	4P 3d, 4d, 3d + N/2
	400 A	C40W32D250	C40W42D250
NSX630HB2 (85 kA at 500 V - 100 kA at 690 V)	630 A	C40W32D400	C40W42D400
		C63W32D630	C63W42D630

Electronic trip unit MicroLogic 5.3 E (LSI protection, energy meter)

DB438109.ai

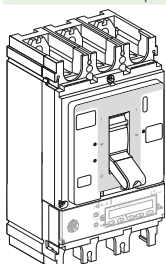

NSX400HB2 (85 kA at 500 V - 100 kA at 690 V)	400 A	3P 3d	4P 3d, 4d, 3d + N/2, 3d + OSN
		C40W35E400	C40W45E400
NSX630HB2 (85 kA at 500 V - 100 kA at 690 V)	630 A	C63W35E630	C63W45E630

Electronic trip unit MicroLogic 6.3 E (LSIG protection, energy meter)

DB438109.ai

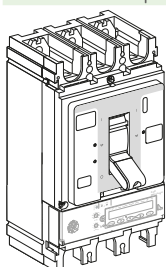

NSX400HB2 (85 kA at 500 V - 100 kA at 690 V)	400 A	3P 3d	4P 3d, 4d, 3d + N/2, 3d + OSN
		C40W36E400	C40W46E400
NSX630HB2 (85 kA at 500 V - 100 kA at 690 V)	630 A	C63W36E630	C63W46E630

Electronic trip unit MicroLogic 1.3 M (I motor protection)

DB438109.ai

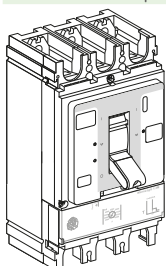

NSX400HB2 (85 kA at 500 V - 100 kA at 690 V)	320 A	3P 3d	
		C40W31M320	
NSX630HB2 (85 kA at 500 V - 100 kA at 690 V)	500 A	C63W31M500	

Electronic trip unit MicroLogic 2.3 M (LS₀I motor protection)

DB438109.ai

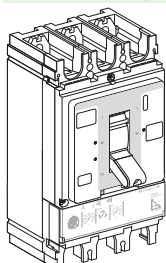

NSX400HB2 (85 kA at 500 V - 100 kA at 690 V)	320 A	3P 3d	
		C40W32M320	
NSX630HB2 (85 kA at 500 V - 100 kA at 690 V)	500 A	C63W32M500	

With electronic trip unit MicroLogic 6.3 E-M (LSIG motor protection, energy meter)

DB438109.ai

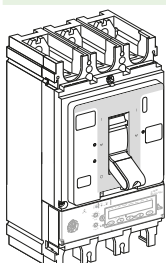

NSX400HB2 (85 kA at 500 V - 100 kA at 690 V)	320 A	3P 3d	
		C40W36M320	
NSX630HB2 (85 kA at 500 V - 100 kA at 690 V)	500 A	C63W36M500	

F

Catalog Numbers

Complete Fixed Device

ComPacT NSX400/630NA

ComPacT NSX400K (10 KA - 1000V AC)

ComPacT NSX400K

Special application

DB438196.ai

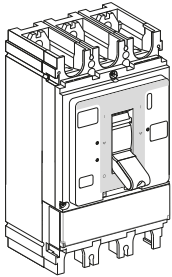

	3P	4P
ComPacT NSX400K, 250 A, MicroLogic 2.3	C40K32D250	C40K42D250
ComPacT NSX400K, 400 A, MicroLogic 2.3	C40K32D400	C40K42D400

ComPacT NSX400/630 NA Switch-Disconnecter

With NA switch-disconnector unit

DB438196.ai

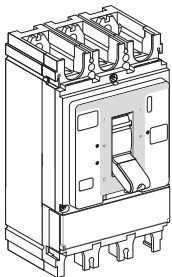

	3P	4P
ComPacT NSX400 NA	C403400S	C404400S
ComPacT NSX630 NA, 45 mm pitch	C633630S	C634630S

Based on Separate Components

ComPacT NSX400/630

Basic Frame

DB4258197.ai

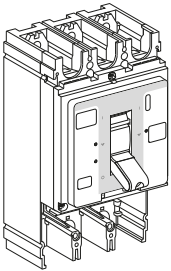

ComPacT NSX400

	3P	4P
NSX400F (36 kA 380/415 V)	C40F3	C40F4
NSX400N (50 kA 380/415 V)	C40N3	C40N4
NSX400H (70 kA 380/415 V)	C40H3	C40H4
NSX400S (100 kA 380/415 V)	C40S3	C40S4
NSX400L (150 kA 380/415 V)	C40L3	C40L4

ComPacT NSX630

	3P	4P
NSX630F (36 kA 380/415 V)	C63F3	C63F4
NSX630N (50 kA 380/415 V)	C63N3	C63N4
NSX630H (70 kA 380/415 V)	C63H3	C63H4
NSX630S (100 kA 380/415 V)	C63S3	C63S4
NSX630L (150 kA 380/415 V)	C63L3	C63L4

+ Trip Unit

Distribution protection

DB111461.eps

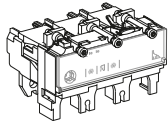

MicroLogic 2.3 (LS₀I protection)

Rating	3P 3d	4P 3d, 4d, 3d + N/2
MicroLogic 2.3 250 A	C4032D250	C4042D250
MicroLogic 2.3 400 A	C4032D400	C4042D400
MicroLogic 2.3 630 A	C6332D630	C6342D630

DB111462.eps

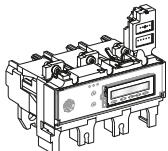

MicroLogic 5.3 E (LSI protection, energy meter)

Rating	3P 3d	4P 3d, 4d, 3d + N/2, 3d + OSN
MicroLogic 5.3 E 400 A	C4035E400	C4045E400
MicroLogic 5.3 E 630 A	C6335E630	C6345E630

DB111462.eps

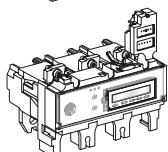

MicroLogic 6.3 E (LSIG protection, energy meter)

Rating	3P 3d	4P 3d, 4d, 3d + N/2, 3d + OSN
MicroLogic 6.3 E 400 A	C4036E400	C4046E400
MicroLogic 6.3 E 630 A	C6336E630	C6346E630

Distribution protection with embedded earth leakage protection

DB425917.eps

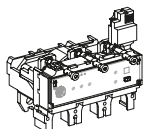

With electronic trip unit MicroLogic Vigi 4.3 (LS₀IR protection)

Rating	3P 3d	4P 4d 3d + N/2
400 A	C4034V400	C4044V400
570 A	C6334V570	C6344V570

DB425919.eps

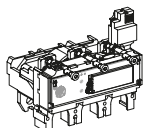

With electronic trip unit MicroLogic Vigi 7.3 E (LSIR protection)

Rating	3P 3d	4P 4d 3d + N/2
400 A	C4037E400	C4047E400
570 A	C6337E570	C6347E570

Distribution protection with embedded earth leakage protection alarm

DB425918.eps

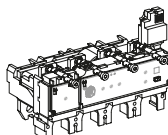

With electronic trip unit MicroLogic Vigi 4.3 AL (LS₀I protection + earth leakage alarm)

Rating	3P 3d	4P 4d 3d + N/2
400 A	C4034A400	C4044A400
570 A	C6334A570	C6344A570

DB425920.eps

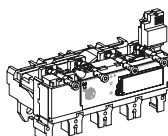

With electronic trip unit MicroLogic Vigi 7.3 E AL (LSI protection + earth leakage alarm)

Rating	3P 3d	4P 4d 3d + N/2
400 A	C4037A400	C4047A400
570 A	C6337A570	C6347A570

Based on Separate Components

ComPacT NSX400/630

+ Trip Unit

Motor protection

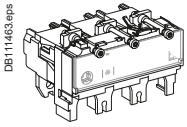

MicroLogic 1.3 M (I protection)

Rating	3P 3d	4P 3d
MicroLogic 1.3 M 320 A	C4031M320	C4041M320
MicroLogic 1.3 M 500 A	C6331M500	C6341M500

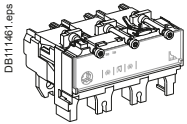

MicroLogic 2.3 M (LS₀I protection)

Rating	3P 3d
MicroLogic 2.3 M 320 A	C4032M320
MicroLogic 2.3 M 500 A	C6332M500

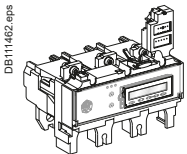

MicroLogic 6.3 E-M (LSIG protection, energy meter)

Rating	3P 3d
MicroLogic 6.3 E-M 320 A	C4036M320
MicroLogic 6.3 E-M 500 A	C6336M500

Protection of public distribution systems

MicroLogic 2.3 AB (LS₀I protection)

Rating	4P 3d, 4d, 3d + N/2
MicroLogic 2.3 400 A	C4042B400

16 Hz 2/3 network protection

MicroLogic 5.3 A-Z (LSI protection, ammeter)

Rating	3P 3d
MicroLogic 5.3 A-Z 630 A	C6335Z630

Earth Leakage protection of public distribution systems

MicroLogic Vigi 4.3 AB distribution protections

Rating	4P 4d 3d + N/2
400 A	C4044B400

+ VigiPacT add-on Protection and Alarm Modules

VigiPacT add-on protection

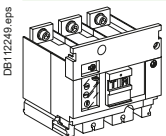

200 to 440 V	3P	4P
440 to 550 V	LV432464	LV432465
Connection for a 4P VigiPacT on a 3P breaker	LV432466	LV432467
		LV432457

VigiPacT add-on alarm

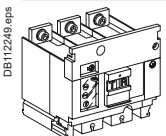

200 to 440 V	3P	4P
Connection for a 4P insulation monitoring module on a 3P breaker	LV432469	LV432470
		LV432457

F

Trip Unit Accessories

DB112277.eps	External neutral CT for 3 pole breaker with MicroLogic 5/6	
	400-630 A	LV432575
DB112730.eps	24 V DC wiring accessory for MicroLogic 5/6	
	24 V DC power supply connector	LV434210
DB115685.eps	ZSI accessory for NS630b-NW with NSX	
	ZSI module	LV434212
DB432608.eps	External power supply module (24 V DC - 1 A), class 4	
	24-30 V DC	LV454440
	48-60 V DC	LV454441
	100-125 V DC	LV454442
	110-130 V AC	LV454443
200-240 V AC	LV454444	



Catalog Numbers

Installation and Connection

ComPacT NSX400/630

Fixed/RC Device = Fixed/FC Device + Rear Connection Kit

Mixed RC kit

DB4381199.ai

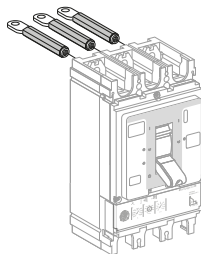

Kit 3P	Short RCs	2 x	LV432475
	Long RCs	1 x	LV432476
Kit 4P	Short RCs	2 x	LV432475
	Long RCs	2 x	LV432476

Plug-in Version = Fixed/FC Device + Plug-in Kit

Kit for ComPacT NSX

DB4381199.ai

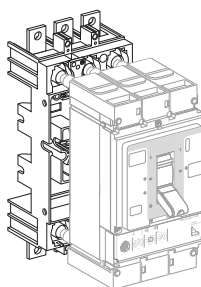

Plug-in kit Comprising:	3P	4P
		LV432538
Base	= 1 x LV432516	= 1 x LV432517
Power connections	+ 3 x LV432518	+ 4 x LV432518
Short terminal shields	+ 2 x LV432591	+ 2 x LV432592
Safety trip interlock	+ 1 x LV432520	+ 1 x LV432520

Catalog Numbers

Installation and Connection

ComPacT NSX400/630

Withdrawable Version = Fixed/FC Device + Withdrawable Kit

Kit for ComPacT NSX

DB43200-01

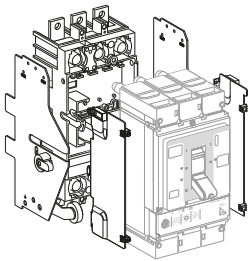









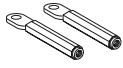

	3P	4P
	Kit for ComPacT NSX	Kit for ComPacT NSX
	=	=
Plug-in kit:	1 x LV432538	1 x LV432539
	+	+
Chassis side plates for base	1 x LV432532	1 x LV432532
	+	+
Chassis side plates for breaker	1 x LV432533	1 x LV432533

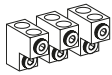

Accessories and Auxiliaries

ComPacT NSX400/630

Connection Accessories (Cu or Al)

Rear connections				
	2 short			LV432475
	2 long			LV432476
Bare cable connectors ^[1]				
	Aluminium connectors	1 x (35 to 300 mm ²)	Set of 3	LV432479
			Set of 4	LV432480
	Aluminium connectors for 2 cables	2 x (35 to 240 mm ²)	Set of 3	LV432481
			Set of 4	LV432482
	6.35 mm voltage tap for aluminium connectors for 1 or 2 cables		Set of 10	LV429348
Terminal extensions ^[1]				
	45° terminal extensions		Set of 3	LV432586
			Set of 4	LV432587
	Edgewise terminal extensions		Set of 3	LV432486
			Set of 4	LV432487
	Right-angle terminal extensions		Set of 3	LV432484
			Set of 4	LV432485
	Spreaders	52.5 mm	3P	LV432490
			4P	LV432491
		70 mm	3P	LV432492
			4P	LV432493
Crimp lugs for copper cable ^[1]				
	For cable 240 mm ²		Set of 3	LV432500
			Set of 4	LV432501
	For cable 300 mm ²		Set of 3	LV432502
			Set of 4	LV432503
Crimp lugs for aluminium cable ^[1]				
	For cable 240 mm ²		Set of 3	LV432504
			Set of 4	LV432505
	For cable 300 mm ²		Set of 3	LV432506
			Set of 4	LV432507
Supplied with 2 or 3 interphase barriers				

[1] Supplied with 2 or 3 interphase barriers.

Insulation accessories

DB425467.eps 	Short terminal shield, 45 mm (1 piece)	3P	LV432591
		4P	LV432592
DB117183.eps 	Short terminal shield > 500 V (1 piece)	3P	LV433693
		4P	LV433694
DB425468.eps 	Long terminal shield, 45 mm (1 piece)	3P	LV432593
		4P	LV432594
DB425469.eps 	Long terminal shield for spreaders, 52.5 mm (1 piece) (supplied with insulating plate)	3P	LV432595
		4P	LV432596
DB425470.eps 	Interphase barriers	Set of 6	LV432570
DB425471.eps 	Connection adapter for plug-in base	3P	LV432584
		4P	LV432585
DB438201.ai 	2 insulating screens (70 mm pitch)	3P	LV432578
		4P	LV432579



Accessories and Auxiliaries

ComPacT NSX400/630

Electrical Auxiliaries

Auxiliary contacts (wired, screwless)

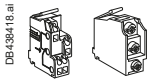

OF or SD or SDE or SDV screwless type	29450
OF or SD or SDE or SDV low level screw type	29452

Auxiliary contacts (wireless)



OF or SD or SDE wireless	LV429454
--------------------------	-----------------

SDx output module for MicroLogic electronic trip unit

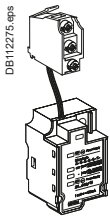

SDx module 24/415 V AC/DC screw type	LV429532
--------------------------------------	-----------------

SDTAM contactor tripping module (early-break thermal fault signal) for MicroLogic 2.3 M/6.3 E-M

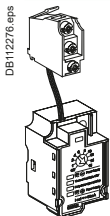

SDTAM 24/415 V AC/DC overload fault indication	LV429424
--	-----------------

Voltage releases

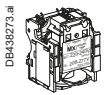

	Voltage	MX	MN
AC	24 V 50/60 Hz	LV429384	LV429404
	48 V 50/60 Hz	LV429385	LV429405
	110-130 V 50/60 Hz	LV429386	LV429406
	220-240 V 50/60 Hz and 208-277 V 60 Hz	LV429387	LV429407
	380-415 V 50 Hz and 440-480 V 60 Hz	LV429388	LV429408
	525 V 50 Hz and 600 V 60 Hz	LV429389	LV429409
DC	12 V	LV429382	LV429402
	24 V	LV429390	LV429410
	30 V	LV429391	LV429411
	48 V	LV429392	LV429412
	60 V	LV429383	LV429403
	125 V	LV429393	LV429413
	250 V	LV429394	LV429414
	MN 48 V 50/60 Hz with fixed time delay		
Composed of:	MN 48 V DC		LV429412
	Delay unit 48 V 50/60 Hz		LV429426
MN 220-240 V 50/60 Hz with fixed time delay			
Composed of:	MN 250 V DC		LV429414
	Delay unit 220-240 V 50/60 Hz		LV429427
MN 48 V DC/AC 50/60 Hz with adjustable time delay			
Composed of:	MN 48 V DC		LV429412
	Delay unit 48 V DC/AC 50/60 Hz		33680
MN 110-130 V DC/AC 50/60 Hz with adjustable time delay			
Composed of:	MN 125 V DC		LV429413
	Delay unit 100-130 V DC/AC 50/60 Hz		33681
MN 220-250 V DC/AC 50/60 Hz with adjustable time delay			
Composed of:	MN 250 V DC		LV429414
	Delay unit 200-250 V DC/AC 50-60 Hz		33682

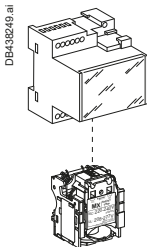

F

Motor Mechanism

Motor mechanism module

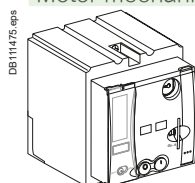
		Voltage	MT400-630
	AC	48-60 V 50/60 Hz	LV432639
		110-130 V 50/60 Hz	LV432640
		220-240 V 50/60 Hz and 208-277 V 60 Hz	LV432641
		380-415 V 50 Hz	LV432642
		440-480 V 60 Hz	LV432647
	DC	24-30 V	LV432643
		48-60 V	LV432644
		110-130 V	LV432645
		250 V	LV432646
		LV432648	

Operation counter

Communicating motor mechanism module

	Motor mechanism module	MTc 400/630	220-240 V 50/60 Hz	LV432652
---	------------------------	-------------	--------------------	----------

+

Breaker status
Communication Module

BSCM	LV434205
------	----------

+

NSX cord

Wire length L = 0.35 m	LV434200
Wire length L = 1.3 m	LV434201
Wire length L = 3 m	LV434202
U > 480 V AC wire length L = 0.35 m	LV434204

Indication and Measurement Modules

PowerLogic PowerTag NSX

	Rating (A)	630
	3P	LV434022
	3P+N	LV434023

Current transformer module

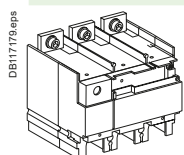
	Rating (A)	400	630
	3P	LV432657	LV432857
	4P	LV432658	LV432858

Current transformer module and voltage output

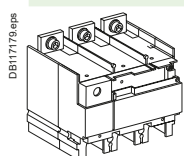
	Rating (A)	400	600
	3P	LV432653	LV432861
	4P	LV432654	LV432862



Accessories and Auxiliaries

ComPacT NSX400/630

Rotary Handles

Direct rotary handle

DB438202.ai

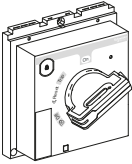

With black handle	LV432597T
With red handle on yellow front	LV432599T
MCC conversion accessory	LV432606T
CNOMO conversion accessory	LV432602T

Extended rotary handle

DB438203.ai

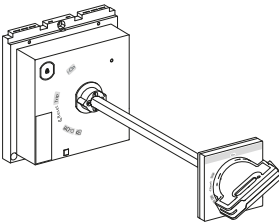

With black handle	LV432598T
With red handle on yellow front	LV432600T
With telescopic handle for withdrawable device	LV432603T

DB421889.eps



Open door shaft operator	LV426937
--------------------------	----------

Accessories for direct or extended rotary handle

Indication auxiliary	1 early-break contact	LV432605
	2 early-make contacts	LV429346

Locks

Toggle locking device for 1 to 3 padlocks

DB438204.ai

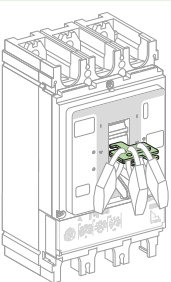

By removable device	29370
---------------------	-------

DB438205.ai

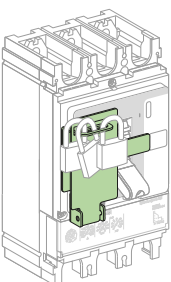

By fixed device for 3P, 4P (open or close position)	LV432631
By fixed device for 3P, 4P (for open position only)	LV432630

Locking of rotary handle

DB438206.ai

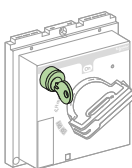

Keylock adapter (keylock not included)	LV432604	
Keylock (keylock adapter not included)	Ronis 1351B.500	41940
	Profalux KS5 B24 D4Z	42888

Locking of motor mechanism module

DB425475.eps

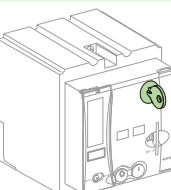

Keylock adapter (keylock not included)	LV432649	
Keylock (keylock adapter not included)	Ronis 1351B.500	41940
	Profalux KS5 B24 D4Z	42888

F

Interlocking

Mechanical interlocking for circuit breakers

DB438419.ai		With toggles	LV432614T
	DB438420.ai		With direct rotary handle
			With extended rotary handle

Interlocking with key (2 keylocks/1 key) for rotary handles

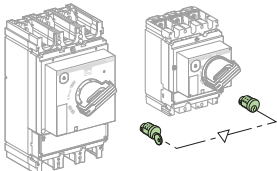
DB438164.ai		Keylock kit (keylock not included) ^[1]	LV432604
		1 set of 2 keylocks	Ronis 1351B.500
		(1 key only, keylock kit not included)	Profalux KS5 B24 D4Z
			42878

Installation Accessories

Front-panel escutcheons

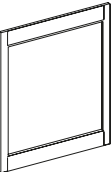
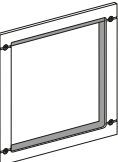
DB111488.eps		IP30 escutcheon for all control types	LV432557
		IP30 trip unit access escutcheon for toggle	LV432559
		IP30 escutcheon for VigiPacT add-on	LV429527
	IP30		
DB111489.eps		IP40 escutcheon for all control types	LV432558
		IP40 escutcheon for VigiPacT add-on	LV429316
		IP40 escutcheon for VigiPacT add-on or ammeter module	LV429318
	IP40		

IP43 rubber toggle cover

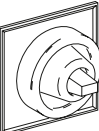
DB111490.eps		1 toggle cover	LV432560 ^[2]
--------------	---	----------------	-------------------------

Lead-sealing accessories

DB115615.eps		Bag of accessories	LV429375
--------------	---	--------------------	----------

60 Mm Plate

DB43207.ai		Plate 3P ComPacT NSX400/630 IEC	LV432623
		Plate 4P ComPacT NSX400/630 IEC	LV432624











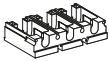

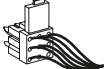
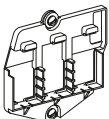
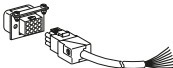
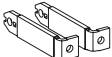
[1] For only 1 device.

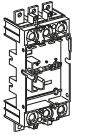
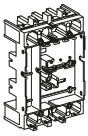
[2] Need to order LV432553, toggle extension to be compatible for IP43 rubber cover.

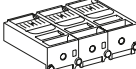
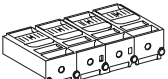
Accessories and Auxiliaries

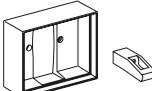

ComPacT NSX400/630

Plug-in/Withdrawable Version Accessories

Insulation accessories			
DB117159.eps 	Connection adapter for plug-in base	3P	LV432584
		4P	LV432585
Auxiliary connections			
DB117160.eps 	1 9-wire fixed connector (for base)		LV429273
DB1171761.eps 	1 9-wire moving connector (for circuit breaker)		LV432523
DB116368.eps 	1 support for 3 moving connectors		LV432525
DB116885.eps 	9-wire manual auxiliary connector (fixed + moving)		LV429272
Plug-in base accessories			
DB432606.eps 	Long insulated right angle terminal extensions	Set of 2	LV432526
DB117165.eps 	2 IP40 shutters for base		LV432521
DB117180.eps 	Base	3P	LV432516
DB117181.eps 	Base	4P	LV432517
DB117192.eps 	Power connections	3/4P	LV432518
DB117183.eps 	Short terminal shields	3P	LV432591
	Short terminal shield > 500 V (1 piece)	3P	LV433693
DB117184.eps 	Short terminal shields	4P	LV432592
	Short terminal shield > 500 V (1 piece)	4P	LV433694
DB117171.eps 	Safety trip interlock	3/4P	LV432520
Chassis accessories			
DB117172.eps 	Escutcheon collar	Toggle	LV432534 ^[1]
DB117173.eps 	Escutcheon collar	VigiPacT add-on	LV429285
DB117163.eps 	Locking kit (keylock not included)		LV429286
DB117163.eps 	Keylock (keylock adapter not included)	Ronis 1351B.500	41940
		Profalux KS5 B24 D4Z	42888
DB11426.eps 	2 carriage switches (connected/disconnected position indication)		LV429287

[1] Need to order LV434436, NSX front cover to be compatible for escutcheon collar for toggle.

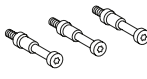
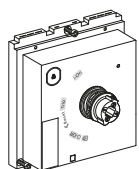
Spare Parts

 <p>DB115330.eps</p>	Additional toggle extension for NSX400/630	32595 ^[1]
 <p>DB11430.eps</p>	5 spare toggle extensions	LV432553
 <p>DB115320.eps</p>	Bag of screws	LV432552
 <p>DB43208.ai</p>	NSX400-630 front cover 3P/4P Retrofit NSX400-630 front cover (F/N/H) 3P/4P NSX400-630 front cover (R/HB1/HB2) 3P/4P	LV434436 LV4344ALT LV4344AHT
 <p>DB11433.eps</p>	IP40 toggle escutcheon	ComPacT NS type/small cut-out 32556
 <p>DB11434.eps</p>	Torque limiting screws (set of 12)	3P/4P ComPacT NSX400-630 LV432513
 <p>DB11438.eps</p>	1 set of 10 identification labels	LV429226
 <p>DB43209.ai</p>	1 base for extended rotary handle	LV432498
 <p>DB11435.eps</p>	LCD display for electronic trip unit	MicroLogic 5 LV429483 MicroLogic 6 LV429484 MicroLogic E-M LV429486
 <p>DB11436.eps</p>	5 transparent covers for electronic trip unit	MicroLogic 5/6 LV432459 MicroLogic 2 LV432461

Individual Enclosures

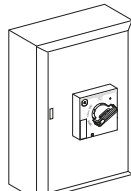
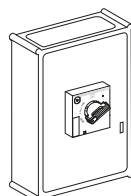
IP55 steel enclosure		
 <p>DB438210.ai</p>	ComPacT NSX400 with black extended rotary handle LV431219 ComPacT NSX400 with red and yellow extended rotary handle LV431220 ComPacT NSX630 or ComPacT NSX400/630 VigiPacT add-on with black extended rotary handle LV431221 ComPacT NSX630 or ComPacT NSX400/630 VigiPacT add-on with red and yellow extended rotary handle LV431222	
IP55 insulating enclosure		
 <p>DB438211.ai</p>	ComPacT NSX400/630 with black extended rotary handle LV432665 ComPacT NSX400/630 VigiPacT add-on with black extended rotary handle LV432666	

Visible Break Disconnect Function

See catalog dealing with "ComPacT INV products (visible break)" and the associated accessories. The visible break disconnection function is compatible with fixed front-connected/rear-connected ComPacT NSX devices.

[1] Need to order LV432553, NSX front cover to be compatible for escutcheon collar for toggle.



Communication, Monitoring and Control

ComPacT NSX400/630

Communication Option

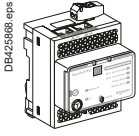
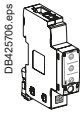
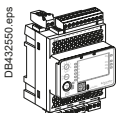
	IFE	Ethernet interface for LV breaker	LV434001
		Ethernet interface for LV breakers and gateway	LV434002
	IFM Modbus-SL interface module		LV434000
	I/O application module		LV434063

Monitoring and Control (Remote Operation)

Circuit breaker accessories

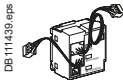
	Breaker Status Control Module	BSCM ^[1]	LV434205
--	-------------------------------	---------------------	----------





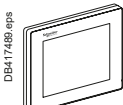

ULP display module^[2]

	Switchboard front display module FDM121		TRV00121
	FDM mounting accessory (diameter 22 mm)		TRV00128

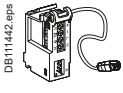
Ethernet display module

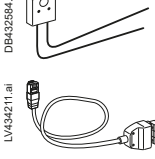
	Switchboard front display module FDM128		LV434128
--	---	--	----------

ULP wiring accessories

	NSX cord L = 0.35 m		LV434200
	NSX cord L = 1.3 m		LV434201
	NSX cord L = 3 m		LV434202
	NSX cord for U > 480 V AC L = 1.3 m		LV434204
	10 stacking connectors for communication interface modules		TRV00217
	2 Modbus line terminators		VW3A8306DRC ^[3]
	Connector Modbus adaptor		LV434211
	RS 485 roll cable (4 wires, length 60 m)		50965
	5 RJ45 connectors female/female		TRV00870
	10 ULP line terminators		TRV00880
	10 RJ45/RJ45 male cord L = 0.3 m		TRV00803
	10 RJ45/RJ45 male cord L = 0.6 m		TRV00806
	5 RJ45/RJ45 male cord L = 1 m		TRV00810
	5 RJ45/RJ45 male cord L = 2 m		TRV00820
	5 RJ45/RJ45 male cord L = 3 m		TRV00830
	1 RJ45/RJ45 male cord L = 5 m		TRV00850

[1] SDE adapter mandatory for trip unit TM, MA or MicroLogic 2 (LV429451).

[2] For measurement display with MicroLogic E or status display with BSCM.

[3] www.schneider-electric.com.

Monitoring and Control, Accessories

ComPacT NSX400/630



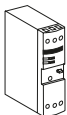
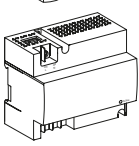

Accessories

Power supply modules

DB112276.eps		External power supply module 100-240 V AC 110-230 V DC/24 V DC-3 A class 2	ABL8RPS24030 ^[1]
DB432038.eps		External power supply module 24 V DC-1 A OVC IV 24-30 V DC 48-60 V DC 100-125 V DC 110-130 V AC 200-240 V AC	LV454440 LV454441 LV454442 LV454443 LV454444

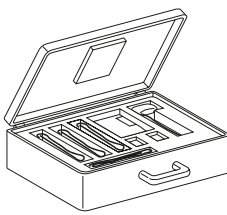
Test Tool, Software, Demo

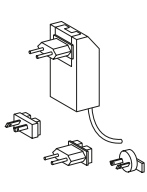
Test tool

DB111446.eps		Pocket battery for MicroLogic NSX100-630	LV434206
DB111451.eps		Maintenance case Comprising: - USB maintenance interface - Power supply - MicroLogic cord - USB cord - RJ45/RJ45 male cord	TRV00910
DB111450.eps		Spare USB maintenance interface	TRV00911
DB111452.eps		Spare power supply 110-240 V AC	TRV00915
DB111453.eps		Spare MicroLogic cord for USB maintenance interface	TRV00917
DB111448.eps		Bluetooth/Modbus option for USB maintenance interface	VW3A8114 ^[1]

[1] See Telemecanique catalog.



Source-Changeover Systems for 2 Devices

ComPacT NSX100 to NSX630

Manual Source-Changeover

Mechanical interlocking

DB439102.ai

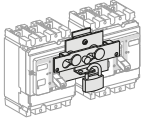

For toggle controlled circuit breakers
NSX100...250
NSX400...630

LV429354T
LV432614T

DB418508.eps

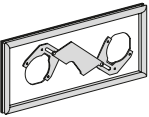

For rotary handled circuit breakers
NSX100...250
NSX400...630

LV429369T
LV432621T

Interlocking on base plate

Dcb439512.ai

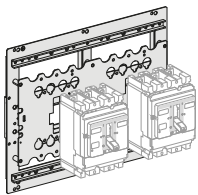

For 2 devices side by side

29349
32609

Keylock interlocking

DB438184.ai

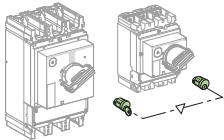

For rotary handled or remote controlled circuit breakers
2 locks, 1 key
Ronis 1351B.500
Profalux KS5 B24 D4Z

41950
42878

Connection Accessories

Downstream coupling accessories

DB101062.eps

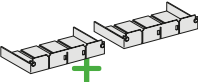

Short terminal shields (1 pair) + "S1" source/"S2" source

3P

4P

NSX100...250/NSX100...250/ 250 A

LV429358

LV429359

NSX400...630/NSX400...630/ 630 A

LV432619

LV432620

DB413273.eps

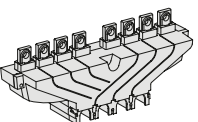

Long terminal shields (1 pair)

NSX100...250/NSX100...250

LV429518

NSX400...630/NSX400...630

LV432594

Long terminal shield for spreaders,
52.5 mm (1 piece)

LV432596

LV432596

Terminal Extensions

DB115622.eps



Spreaders 52.5 mm

4P LV432491

F

Source-Changeover Systems for 2 Devices

ComPacT NSX100 to NSX630

Typical Composition of Source-Changeover System

Remote source-changeover

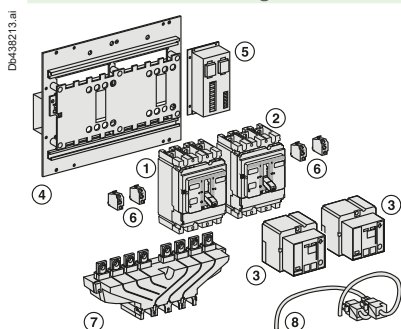

- 1 normal device N (1)
- + 1 replacement device R (2)
- + 2 remote controls (3)
- + 1 plate with interlocking (4) with IVE (5) and its wiring (8)
- + 2 plug-in kits (if plug-in version)
- + 1 adaptor kit for NSX100...250 plug-in (if NSX400...630 with NSX100...250)
- + auxiliary switches (6)
- 2 x (1 OF + 1 SDE) for ComPacT NSX100...630
- + 1 downstream coupling accessory (7) for ComPacT NSX100...630 (option)
- + long RC (if back connection)

IVE and remote controls must have the same voltage.

Associated controller

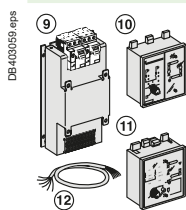

- 1 source changeover without associated controller
- + 1 ACP (9) with BA controller (10)
- Or + 1 ACP (9) with UA controller (11)
- Or + 1 ACP (9) with UA150 controller (11)
- + extension (12) for remote UA/BA connection on front of switchboard

IVE + remote control + ACP + BA or UA must have the same voltage.

Automatic Source-Changeover

Mechanical and electrical interlocking

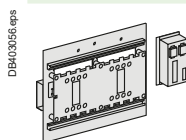

Source "normal"/source "replacement" (identical voltages)	24 to 250 V DC	48 to 415 V AC 50/60 Hz 440 V 60 Hz
NSX100...250/NSX100...250		
Plate + IVE	29351	29350
Plate	29349	29349
IVE	29356	29352
Auxiliary switches 2 OF + 2 SDE	4 x 29450	4 x 29450
Spare wiring system (device/IVE)	29365	29365
Back sockets option add: Only long RC	[2]	[2]
Plug in base option add: Plug in kit	[2]	[2]
NSX400...630/NSX100...630		
Plate + IVE	32611	32610
Plate	32609	32609
IVE	29356	29352
Auxiliary switches 2 OF + 2 SDE	4 x 29450	4 x 29450
Spare wiring system (device/IVE)	29365	29365
Back sockets option add: Only long RC	[2]	[2]
Plug in base option add: Plug in kit	[2]	[2]
Adaptator kit for NSX100...250	1 x 32618	1 x 32618

Controller

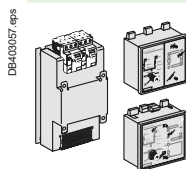

	110/127 V AC 50/60 Hz	220/240 V AC 50/60 Hz	380/415 V AC 50/60 Hz 440 V 60 Hz
ACP + controller BA [1]		29470	29471
Plate ACP		29363	29364
Controller BA		29376	29377
ACP + controller UA [1]	29448	29472	29473
Plate ACP	29447	29363	29364
Controller UA	29446	29378	29380

Wiring cable between BA/UA and ACP/IVE

Wiring cable (1.5 meter)	29368	29368
--------------------------	--------------	--------------

[1] The supply voltages BA/UA controller, ACP plate, IVE and the remote control must be identical whatever the source-changeover type.
 [2] See products pages.

ComPacT NSX100 to NSX630 Order Form

Name of customer:
 Address for delivery:
 Requested delivery date:
 Customer order no.:

To indicate your choices, check the applicable square boxes
 or note the quantity
 and enter the appropriate information in the rectangles

Circuit breaker or switch-disconnector

ComPacT type	NSX100/160/250 - 160A not available with R, HB1 or HB2 NSX400/630
Rating	A
Circuit breaker	B, F, N, H, S, L, R, HB1, HB2
Switch-disconnector	NA
Number of poles	1, 2, 3 or 4
Number of poles protected	2d, 3d or 4d
Fixed device	Front connections <input type="checkbox"/>
Plug-in/withdr.	Plug-in <input type="checkbox"/> Withdrawable <input type="checkbox"/>
Earth-leakage protection	ME, MH, MB (not available with R, HB1 or HB2)

Trip unit

Thermal-mag.	TMD rating (16 ... 250 A) (40 ... 250 A) with R, HB1 and (63...250 A) with HB2 <input type="checkbox"/>
	TMG rating (16 ... 250 A) - not available with R, HB1 or HB2 <input type="checkbox"/>
	MA rating (2.5 ... 220 A) (12.5 ... 220 A) with R, HB1 and HB2 <input type="checkbox"/>

Electronic * Not available with R, HB1 or HB2	MicroLogic 2.2	MicroLogic 2.3
	MicroLogic 2.2 G*	MicroLogic 2.3 AB*
	MicroLogic 2.2 AB*	MicroLogic Vigi 4.3
	MicroLogic Vigi 4.2	MicroLogic Vigi 4.3 AL
	MicroLogic Vigi 4.2 AL	MicroLogic Vigi 4.3 AB
	MicroLogic Vigi 4.2 AB	MicroLogic 5.3 A*
	MicroLogic 5.2 A*	MicroLogic 5.3 E
	MicroLogic 5.2 E	MicroLogic 5.3 A-Z*
	MicroLogic 5.2 A-Z*	MicroLogic 6.3 A*
	MicroLogic 6.2 A*	MicroLogic 6.3 E
	MicroLogic 6.2 E	MicroLogic Vigi 7.3 E
	MicroLogic Vigi 7.2 E	MicroLogic Vigi 7.3 EAL
	MicroLogic Vigi 7.2 AL	MicroLogic 1.3 M
	MicroLogic 2.2 M	MicroLogic 2.3 M
	MicroLogic 6.2 E-M	MicroLogic 6.3 E-M

External neutral CT	<input type="checkbox"/>
24 V DC power supply connector	<input type="checkbox"/>
ZSI connector accessory for plug-in and withdrawable	<input type="checkbox"/>
ZSI wiring accessory for NS630B/MTZ	<input type="checkbox"/>
External power supply module 24 V DC	<input type="checkbox"/>
24-30 V DC	<input type="checkbox"/> 48-60 V DC <input type="checkbox"/>
100-125 V AC	<input type="checkbox"/> 110-130 V AC <input type="checkbox"/>
200-240 V AC	<input type="checkbox"/>
Battery module	<input type="checkbox"/>

Connection

Rear-connection kit	Short <input type="checkbox"/> Mixed <input type="checkbox"/> Long <input type="checkbox"/>
NSX100/250 connectors	Snap-on 1.5 [□] to 95 [□] (< 160 A) Snap-on 25 [□] to 95 [□] (< 250 A) Snap-on 120 [□] to 185 [□] (< 250 A) Distribution 6 x 1.5 [□] to 35 [□] Aluminium 1 cable 25 to 95 Aluminium 1 cable 120 to 185 Aluminium 1 cable 120 to 250 Aluminium 2 cables 50 [□] to 120 [□]
NSX400/630 connectors	1 cable 35 [□] to 300 [□] 2 cables 35 [□] to 240 [□]
Right-angle terminal extensions	<input type="checkbox"/>
Straight extensions	NSX100/250 <input type="checkbox"/>
Edgewise extensions	45° terminal extension <input type="checkbox"/> Double-L terminal extensions <input type="checkbox"/>
Spreader	NSX100/250 (one piece) <input type="checkbox"/> (45 mm) NSX400/630 (52.5 mm) <input type="checkbox"/> (70 mm)
Cu cable lugs	NSX100/250 120 [□] <input type="checkbox"/> 150 [□] <input type="checkbox"/> 185 [□] <input type="checkbox"/> NSX400/630 240 [□] <input type="checkbox"/> 300 [□] <input type="checkbox"/>
Al cable lugs	NSX100/250 150 [□] <input type="checkbox"/> 185 [□] <input type="checkbox"/> NSX400/630 240 [□] <input type="checkbox"/> 300 [□] <input type="checkbox"/>
Voltage measurement	For lugs NSX100/250 ≤ 185 [□] <input type="checkbox"/>
Input for connector	For lugs NSX400/630 <input type="checkbox"/>
Terminal shields	NSX100/250 Short <input type="checkbox"/> Long <input type="checkbox"/> NSX400/630 Short <input type="checkbox"/> Long <input type="checkbox"/> Short ≥ 50 V <input type="checkbox"/> Long for 52.5 mm spreaders <input type="checkbox"/>
Interphase barriers	Set of 6 <input type="checkbox"/>
2 insulating screens: NSX100/250	<input type="checkbox"/>
NSX400/630	70 pitch <input type="checkbox"/>

Test tool

Pocket battery for MicroLogic	<input type="checkbox"/>	Power supply 110-240 V AC	<input type="checkbox"/>
Maintenance case	<input type="checkbox"/>	Spare MicroLogic cord	<input type="checkbox"/>
USB maintenance interface	<input type="checkbox"/>		

Indication and measurement

PowerLogic PowerTag NSX	<input type="checkbox"/>	3P	<input type="checkbox"/>	4P	<input type="checkbox"/>
Ammeter module	standard <input type="checkbox"/> I max <input type="checkbox"/>	3P	<input type="checkbox"/>	4P	<input type="checkbox"/>
Current-transformer module	<input type="checkbox"/>	3P	<input type="checkbox"/>	4P	<input type="checkbox"/>
Current-transformer module + TCU	<input type="checkbox"/>	3P	<input type="checkbox"/>	4P	<input type="checkbox"/>
Insulation-monitoring module - not available with HB1 or HB2	<input type="checkbox"/>	3P	<input type="checkbox"/>	4P	<input type="checkbox"/>
Voltage-presence indicator - not available with HB1 or HB2	<input type="checkbox"/>				
Auxiliary contact	OF, SD, SDE or SDV	Standard	<input type="checkbox"/>	Low level	<input type="checkbox"/>
SDE adapter (TM, MA or MicroLogic 2 trip units)	<input type="checkbox"/>				
SDX module	<input type="checkbox"/>				

Remote operation

Electrical operation	Motor mechanism	AC	<input type="checkbox"/>	DC	<input type="checkbox"/>	V	<input type="checkbox"/>
Voltage releases	Instantaneous	MX	AC	<input type="checkbox"/>	DC	<input type="checkbox"/>	V
		MN	AC	<input type="checkbox"/>	DC	<input type="checkbox"/>	V
	Fixed time delay	MN	AC	<input type="checkbox"/>	DC	<input type="checkbox"/>	V
	Adjust. time delay	MN	AC	<input type="checkbox"/>	DC	<input type="checkbox"/>	V

Rotary handles

Direct	Black <input type="checkbox"/> MCC conversion access. <input type="checkbox"/>	Red and yellow front <input type="checkbox"/> CNOMO conversion access. <input type="checkbox"/>
Extended	Black <input type="checkbox"/> Telescopic handle for withdrawable device <input type="checkbox"/>	Red and yellow front <input type="checkbox"/>
	Open door shaft operator <input type="checkbox"/>	
Indication auxiliary	1 early-break switch <input type="checkbox"/>	2 early-make switches <input type="checkbox"/>

Locking

Toggle (1 to 3 padlocks)	Removable <input type="checkbox"/>	Fixed <input type="checkbox"/>
Rotary handle	Keylock adapter (keylock not included) <input type="checkbox"/> Keylocks Ronis 1351B.500 <input type="checkbox"/>	Profalux KS5 B24 D4Z <input type="checkbox"/>
Motor mechanism	Keylock adapter + keylock Ronis (special) <input type="checkbox"/> Keylock adapter (keylock not included) <input type="checkbox"/> Keylocks Ronis 1351B.500 <input type="checkbox"/>	NSX100/250 <input type="checkbox"/> NSX400/630 <input type="checkbox"/> Profalux KS5 B24 D4Z <input type="checkbox"/>

Interlocking

Mechanical	Toggle operated <input type="checkbox"/>	Rotary Handle <input type="checkbox"/>
By key (2 keylocks, 1 key)	Locking kit without locks <input type="checkbox"/>	
For rotary handle	Keylocks Ronis 1351B.500 <input type="checkbox"/>	Profalux KS5 B24 D4Z <input type="checkbox"/>

Installation accessories

IP30 escutcheon for all types (toggle/rotary handle/motor mechanism)	<input type="checkbox"/>
IP30 escutcheon (with access to toggle + trip unit)	<input type="checkbox"/>
IP30 escutcheon for VigiPacT add-on	<input type="checkbox"/>
IP40 escutcheon for all types (toggle/rotary handle/motor mechanism)	<input type="checkbox"/>
IP40 escutcheon for VigiPacT add-on	<input type="checkbox"/>
IP40 escutcheon for VigiPacT add-on or ammeter module	<input type="checkbox"/>
Toggle cover	<input type="checkbox"/>
Sealing accessories	<input type="checkbox"/>
DIN rail adapter	NSX100/250 <input type="checkbox"/>
3P 60 mm busbar adapter	<input type="checkbox"/>

Plug-in/withdrawable configuration accessories

Auxiliary connections	1 automatic connector fixed part with 9 wires (for base) <input type="checkbox"/> 1 automatic connector moving part with 9 wires (for circuit breaker) <input type="checkbox"/> 1 support for 3 automatic connector moving parts <input type="checkbox"/> 1 support for 2 automatic connector <input type="checkbox"/>
9-wire manual auxiliary connector (fixed + moving)	<input type="checkbox"/>
Plug-in base accessories	Long insulated terminals <input type="checkbox"/> Set of 2 <input type="checkbox"/> 2 IP4 shutters for base <input type="checkbox"/>
Chassis accessories	Escutcheon collar <input type="checkbox"/> Toggle <input type="checkbox"/> Vigi <input type="checkbox"/> Locking kit (keylock not included) <input type="checkbox"/> 2 carriage switches (conn./disconnected position indication) <input type="checkbox"/>
Parts or plug-in	Plug-in base FC/RC 2P <input type="checkbox"/> 3P <input type="checkbox"/> 4P <input type="checkbox"/>
Withdrawable kits	Set of two power connections <input type="checkbox"/> Standard <input type="checkbox"/> Vigi <input type="checkbox"/> Safety trip for advanced opening <input type="checkbox"/> For 3P/4P chassis <input type="checkbox"/> Moving part <input type="checkbox"/> Fixed part <input type="checkbox"/>
Adapter for plug-in base (for terminal shield or interphase barriers)	<input type="checkbox"/>

Communication

NSX Cord L = 0.35 m	<input type="checkbox"/>	NSX Cord L = 1.3 m	<input type="checkbox"/>
NSX Cord U > 480 V AC L = 0.35 m	<input type="checkbox"/>	NSX Cord L = 3 m	<input type="checkbox"/>

BSCM

Communicating motor mechanism 220-240 V	<input type="checkbox"/>
Switchboard front display module FDM121	<input type="checkbox"/>
FDM mounting accessory	<input type="checkbox"/>
Ethernet Interface + Gateway	<input type="checkbox"/>
Ethernet Interface	<input type="checkbox"/>
Modbus interface	<input type="checkbox"/>
I/O Application Module	Qty 1 <input type="checkbox"/> Qty 2 <input type="checkbox"/>
Stacking accessory	<input type="checkbox"/>
ULP line termination	<input type="checkbox"/>
RJ45 connectors female/female	Wire length RJ45 L = 0.3 m <input type="checkbox"/> Wire length RJ45 L = 0.6 m <input type="checkbox"/> Wire length RJ45 L = 1 m <input type="checkbox"/> Wire length RJ45 L = 2 m <input type="checkbox"/> Wire length RJ45 L = 3 m <input type="checkbox"/> Wire length RJ45 L = 5 m <input type="checkbox"/>

Glossary

Accessories.....	G-2
Circuit-Breaker Characteristics (IEC 60947-2).....	G-2
Communication.....	G-4
Components.....	G-6
Controls.....	G-6
Selectivity/Cascading.....	G-6
Environment.....	G-7
Harmonics.....	G-8
Measurements.....	G-9
Protection.....	G-10
Relays and Auxiliary Contacts.....	G-10
Switchgear.....	G-11
Three-Phase Asynchronous Motors and Their Protection.....	G-11
Trip Units.....	G-12

Other chapters

Select Circuit Breakers and Switch-Disconnectors.....	A-1
Select Protection.....	B-1
Customize Circuit Breakers with Accessories.....	C-1
Smart Panel Integration.....	D-1
Switchboard Integration.....	E-1
Catalog Numbers.....	F-1
Additional Characteristics.....	H-1

Glossary

For each major section (Accessories, Switchgear, etc.) and for each item (Adapter for plug-in base, Connection terminal, etc.), this glossary provides:

- The page number in the concerned catalog
- The reference standard
- The standardized IEC symbol
- The definition.

Text in quotation marks is drawn from the standards.

Accessories

Adapter for plug-in base	The adapter is a plastic component that can be installed upstream and/or downstream of the plug-in base and enables use of all the connection accessories of the fixed device.
Bare-cable connector	Conducting part of the circuit breaker intended for connection to power circuits. On ComPacT NSX, it is an aluminium part that screws to the connection terminals of the circuit breaker. There are one or more holes (single or multiple cable connector) for the ends of bare cables.
Connection terminals	Flat copper surface, linked to the conducting parts of the circuit breaker and to which power connections are made using bars, connectors or lugs.
One-piece spreader	The spreader is a plastic component with copper connectors that can be installed upstream and/or downstream of a ComPacT NSX100 to 250 circuit breaker with a pole pitch of 35 mm. It increases the pitch of the circuit-breaker terminals to the 45 mm pitch of a NSX400/630 device to facilitate connection of large cables.
Spreaders	Set of three (3P device) or four (4P) flat, conducting parts made of aluminium. They are screwed to the circuit-breaker terminals to increase the pitch between poles.

Circuit-breaker characteristics (IEC 60947-2)

Breaking capacity	Value of prospective current that a switching device is capable of breaking at a stated voltage under prescribed conditions of use and behaviour. Reference is generally made to the ultimate breaking capacity (Icu) and the service breaking capacity (Ics).
Degree of protection (IP) IEC 60529	<p>Defines device protection against the penetration of solid objects and liquids, using two digits specified in standard IEC 60259. Each digit corresponds to a level of protection, where 0 indicates no protection.</p> <ul style="list-style-type: none"> ■ First digit (0 to 6): protection against penetration of solid foreign objects. 1 corresponds to protection against objects with a diameter > 50 mm, 6 corresponds to total protection against dust. ■ Second digit (0 to 8): protection against penetration of liquids (water). 1 corresponds to protection against falling drops of water (condensation), 8 corresponds to continuous immersion. <p>The enclosure of ComPacT NSX circuit breakers provides a minimum of IP40 (protection against objects > 1 mm) and can reach IP56 (protection against dust and powerful water jets) depending on the installation conditions.</p>
Degree of protection against external mechanical impacts (IK)	<p>Defines the aptitude of an object to resist mechanical impacts on all sides, indicated by a number from 0 to 10 (standard IEC 62262). Each number corresponds to the impact energy (in Joules) that the object can handle according to a Standardized procedure.</p> <p>0 corresponds to no protection, 1 to an impact energy of 0.14 Joules, 10 to an impact energy of 20 Joules. ComPacT NSX provide IK07 (2 Joules) and can provide IK08 (5 Joules) depending on the installation conditions.</p>
Durability	The term "durability" is used in the standards instead of "endurance" to express the expectancy of the number of operating cycles which can be performed by the equipment before repair or replacement of parts. The term "endurance" is used for specifically defined operational performance.
Electrical durability IEC 60947-1	With respect to its resistance to electrical wear, equipment is characterized by the number of on-load operating cycles, corresponding to the service conditions given in the relevant product standard, which can be made without re replacement.



Frame size	<p>A term designating a group of circuit breakers, the external physical dimensions of which are common to a range of current ratings. Frame size is expressed in amperes corresponding to the highest current rating of the group. Within a frame size, the width may vary according to the number of poles. This definition does not imply dimensional standardization.</p> <p>ComPacT NSX has two frame sizes covering 100 to 250 A and 400 to 630 A.</p>
Insulation class	<p>Defines the type of device insulation in terms of earthing and the corresponding safety for user, in one of three classes.</p> <ul style="list-style-type: none"> ■ Class I. The device is earthed. Any electrical faults, internal or external, or caused by the load, are cleared via the earthing circuit, thus ensuring user safety. ■ Class II. The device is not connected to a protective conductor. User safety is ensured by reinforced insulation around the live parts (an insulating case and no contact with live parts, i.e. plastic buttons, molded connections, etc.) or double insulation. ■ Class III. The device may be connected only to SELV (safety extra-low voltage) circuits. The ComPacT NSX are class II devices (front) and may be installed through the door in class II switchboards (standards IEC 61140 and IEC 60664-1), without reducing insulation, even with a rotary handle or motor mechanism module.
Making capacity	<p>Value of prospective making current that a switching device is capable of making at a stated voltage under prescribed conditions of use and behaviour. Reference is generally made to the short-circuit making capacity I_{cm}.</p>
Maximum break time	<p>Maximum time after which breaking is effective, i.e. the contacts separated and the current completely interrupted.</p>
Mechanical durability	<p>With respect to its resistance to mechanical wear, equipment is characterized by the number of no-load operating cycles which can be effected before it becomes necessary to service or replace any mechanical parts.</p>
Non-tripping time	<p>This is the minimum time during which the protective device does not operate in spite of pick-up overrun, if the duration of the overrun does not exceed the corresponding voluntary time delay.</p>
Pollution degree of environment conditions IEC 60947-1 IEC 60664-1	<p>Conventional number based on the amount of conductive or hygroscopic dust, ionized gas or salt and on the relative humidity and its frequency of occurrence, resulting in hygroscopic absorption or condensation of moisture leading to reduction in dielectric strength and/or surface resistivity. Standard IEC 60947-1 distinguishes four pollution degrees.</p> <ul style="list-style-type: none"> ■ Degree 1. No pollution or only dry, non-conductive pollution occurs. ■ Degree 2. Normally, only non-conductive pollution occurs. Occasionally, however, a temporary conductivity caused by condensation may be expected. ■ Degree 3. Conductive pollution occurs, or dry, non-conductive pollution occurs which becomes conductive due to condensation. ■ Degree 4. The pollution generates persistent conductivity caused, for instance, by conductive dust or by rain or snow. ComPacT NSX meets degree 3, which corresponds to industrial applications.
Prospective short-circuit current	<p>Current that would flow through the poles if they remained fully closed during the short-circuit.</p>
Rated current (In)	<p>This is the current that the device can carry continuously with the contacts closed and without abnormal temperature rise.</p>
Rated impulse withstand voltage (Uimp)	<p>The peak value of an impulse voltage of prescribed form and polarity which the equipment is capable of withstanding without failure under specified conditions of test and to which the values of the clearances are referred. The rated impulse withstand voltage of an equipment shall be equal to or higher than the values stated for the transient overvoltages occurring in the circuit in which the equipment is fitted.</p>
Rated insulation voltage (Ui)	<p>The rated insulation voltage of an equipment is the value of voltage to which dielectric tests and creepage distances are referred. In no case shall the maximum value of the rated operational voltage exceed that of the rated insulation voltage.</p>
Rated operational current (Ie)	<p>A rated operational current of an equipment is stated by the manufacturer and takes into account the rated operational voltage, the rated frequency, the rated duty, the utilization category and the type of protective enclosure, if appropriate.</p>
Rated operational voltage (Ue)	<p>A value of voltage which, combined with a rated operational current, determines the application of the equipment and to which the relevant tests and the utilization categories are referred. For multipole equipment, it is generally stated as the voltage between phases.</p> <p>This is the maximum continuous voltage at which the equipment may be used.</p>

Glossary

Rated short-time withstand current (Icw)	Value of short-time withstand current, assigned to the equipment by the manufacturer, that the equipment can carry without damage, under the test conditions specified in the relevant product standard. Generally expressed in kA for 0.5, 1 or 3 seconds. This is an essential characteristic for air circuit breakers. It is not significant for molded-case circuit breakers for which the design targets fast opening and high limiting capacity.
Service breaking capacity (Ics)	Expressed as a percentage of Icu, it provides an indication on the robustness of the device under severe conditions. It is confirmed by a test with one opening and one closing/opening at Ics, followed by a check that the device operates correctly at its rated current, i.e. 50 cycles at In, where temperature rise remains within tolerances and the protection system suffers no damage.
Short-circuit making capacity (Icm)	Value indicating the capacity of the device to make and carry a high current without repulsion of the contacts. It is expressed in kA peak.
Suitability for isolation (see also below Positive contact indication)	<p>This capability means that the circuit breaker meets the conditions below.</p> <ul style="list-style-type: none"> ■ In the open position, it must withstand, without flashover between the upstream and downstream contacts, the impulse voltage specified by the standard as a function of the Uimp indicated on the device. ■ It must indicate contact position by one or more of the following systems: <ul style="list-style-type: none"> □ Position of the operating handle □ Separate mechanical indicator □ Visible break of the moving contacts ■ Leakage current between each pole, with the contacts open, at a test voltage of 1.1 x the rated operating voltage, must not exceed: <ul style="list-style-type: none"> □ 0.5 mA per pole for new devices □ 2 mA per pole for devices already subjected to normal switching operations □ 6 mA, the maximum value that must never be exceeded. ■ It must not be possible to install padlocks unless the contacts are open. Locking in the closed position is permissible for special applications. ComPacT NSX complies with this requirement by positive contact indication.
Suitable for isolation with positive contact indication (see also above Suitability for isolation)	<p>Suitability for isolation is defined here by the mechanical reliability of the position indicator of the operating mechanism, where:</p> <ul style="list-style-type: none"> ■ The isolation position corresponds to the O (OFF) position ■ The operating handle cannot indicate the "OFF" position unless the contacts are effectively open. <p>The other conditions for isolation must all be fulfilled:</p> <ul style="list-style-type: none"> ■ Locking in the open position is possible only if the contacts are effectively open ■ Leakage currents are below the Standardized limits ■ Overvoltage impulse withstand between upstream and downstream connections.
Ultimate breaking capacity (Icu)	Expressed in kA, it indicates the maximum breaking capacity of the circuit breaker. It is confirmed by a test with one opening and one closing/opening at Icu, followed by a check that the circuit is properly isolated. This test ensures user safety.

Communication.....

BSCM (Breaker status and control module)	The optional BSCM for ComPacT NSX is used to acquire device status indications and control the communicating remote-control function. It includes a memory used to manage the maintenance indicators. It serves as a converter between the analog outputs of the device indication contacts (O/F, SD, SDE) and the digital communicating functions.
Com'X 210 energy server	<p>Com'X 210 energy server is a compact, plug-and-play data logger that merges seamlessly with the Smart Panels energy management solution. It consolidates inputs from analog environmental sensors (e.g. temperature), digital readers (e.g. pulsed signals from smart energy or water meters, load running hours), and energy management equipment running over the Modbus protocol.</p> <p>Designed for ease of implementation, data can be transmitted securely via Ethernet, Wi-Fi, or GPRS to any energy management platforms. The Com'X 210 energy server is scalable and can be easily adaptable to accommodate future upgrades. Com'X 210 is a perfect fit with our energy management services, enabling visualization, tracking, and analysis of energy data to support optimization of energy performance and cost management.</p>
Ethernet TCP/IP (Transmission Control Protocol/Internet Protocol)	<p>Ethernet is a very common network protocol and complies with IEEE standard 802.3. Ethernet TCP/IP is the protocol that brings web functions to Ethernet networks. Most PCs have an Ethernet 10/100 card (10 or 100 Mbit/s) for connection to the internet. Data communicated from ComPacT NSX via Modbus are accessible on a PC via a TCP/IP-Modbus gateway such as MPS100 or EGX100.</p>

FDM121 switchboard display	<p>An FDM121 switchboard display unit can be connected to a ULP IMU using a prefabricated cord to display all measurements, alarms, histories and event tables, maintenance indicators, management of installed devices on a screen. The result is a veritable 96 x 96 mm Power Meter.</p> <p>The FMD121 display unit requires a 24 V DC power supply.</p> <p>The FDM121 is a switchboard display unit that can be integrated in the ComPacT NSX100 to 630 A, PowerPacT H/J/L/P/R, ComPacT NS or MasterPacT systems.</p>
FDM128 switchboard display	<p>The FDM128 is an intelligent Ethernet display. It collects the data from up to 8 devices via Ethernet network.</p> <p>The FDM128 is a large display, but requires very little depth. The anti-glare graphic screen is backlit for very easy reading even under poor ambient lighting and at sharp angles.</p>
IFE Ethernet interface, IFE Ethernet interface + gateway	<p>The IFE Ethernet interface for LV circuit breaker enables an intelligent modular unit (IMU), for example a MasterPacT NT/NW/MTZ or ComPacT NSX circuit breaker to be connected to an Ethernet network.</p>
IFM Module interface Modbus	<p>This module required for connection to the network, contains the Modbus address (1 to 99) declared by the user via the two dials in front. It automatically adapts (baud rate, parity) to the Modbus network in which it is installed.</p> <p>It is equipped with a lock-out switch to enable or disable operations involving writing to MicroLogic, i.e. reset, counter reset, setting modifications, device opening and closing commands, etc. There is a built-in test function to check the connections of the Modbus interface module with the MicroLogic and FDM121 display unit.</p>
I/O application module	<p>The I/O (Input/Output) application module for LV breaker is part of an ULP system with built-in functionalities and applications to enhance the application needs.</p> <p>The ULP system architecture can be built without any restrictions using the wide range of circuit breakers.</p> <p>The I/O application module is compliant with the ULP system specifications.</p> <p>Two I/O application modules can be connected in the same ULP network.</p>
Network	<p>Set of communicating devices that are interconnected by communication lines in order to share data and resources.</p>
Open protocol	<p>A protocol for system communication, interconnection or data exchange for which technical specifications are public, i.e. there are no restrictions on access or implementation. An open protocol is the opposite of a proprietary protocol.</p>
Protocol	<p>Standardized specification for dialog between digital components that exchange data. It is an operating mode based on the length and structure of binary words and it must be used by all the components exchanging data between themselves.</p> <p>Communication is not possible without using a protocol.</p>
RJ45 connector	<p>Universal, 8-wire connector that is widely used in digital communication networks. The RJ45 connector is used to interconnect computer equipment (Ethernet, Modbus, etc.), telephones and audiovisual equipment.</p>
RS485 Modbus	<p>Modbus is the most widely used communication protocol in industrial networks. It operates in master-slave mode. An RS485 multipoint link connects the master and slaves via a pair of wires offering throughputs of up to 38400 bits/second over distances up to 1200 m). The master cyclically polls the slaves which send back the requested information.</p> <p>The Modbus protocol uses frames containing the address of the targeted slave, the function (read, write), the datum and the CRC (cyclical redundancy check).</p>
SDTAM	<p>Relay module with two static outputs specifically for the motor-protection MicroLogic trip units 1 M, 2 M and 6 E-M. An output, linked to the contactor controller, opens the contactor when an overload or other motor fault occurs, thus avoiding opening of the circuit breaker. The other output stores the opening event in memory.</p>
SDx	<p>Relay module with two outputs that remotes the trip or alarm conditions of ComPacT NSX circuit breakers equipped with a MicroLogic electronic trip unit.</p>
Smartlink SI B	<p>Smartlink SI B collects data from Smartlink Modbus and transfers them via the Ethernet network.</p>
Smartlink Modbus	<p>Smartlink Modbus is used to transfer data from devices to a PLC or monitoring system via the communication system: Modbus serial line.</p>
Static output	<p>Output of a relay made up of a thyristor or triac electronic component. The low switching capability means that a power relay is required.</p> <p>This is the case for the SDx and SDTAM outputs.</p>
ULP (Universal Logic Plug) 	<p>Connection system used by ComPacT NSX to communicate information to the Modbus interface via a simple RJ45 cable. Compatible modules are indicated by the symbol opposite.</p>

Glossary

Components

ASIC (Application Specific Integrated Circuit)

Integrated circuit designed, built and intended for a specific application. It carries out repetitive sequences of instructions engraved in the silicon chip. For that reason, it is extremely reliable because it cannot be modified and is not affected by environment conditions.

MicroLogic trip units use an ASIC for the protection functions. The ASIC cyclically polls the network status at a high frequency, using the values supplied by captors. Comparison with the settings forms the basis for orders to the electronic trip units.

Microprocessor

A microprocessor is a more general purpose device than an ASIC. In MicroLogic, a microprocessor is used for measurements and it can be programmed. It is not used for the main protection functions that are carried out by the ASIC.

Controls

Communicating motor mechanism

For ComPacT NSX remote control via the communication system, a communicating motor mechanism is required. Except for the communication function, it is identical to the standard motor mechanism module and connects to and controlled by the BSCM module.

CNOMO machine-tool rotary handle

Handle used for machine-tool control enclosures and providing IP54 and IK08.

Direct rotary handle

This is an optional control handle for the circuit breaker. It has the same three positions I (ON), O (OFF) and TRIPPED as the toggle control. It provides IP40, IK07 and the possibility, due to its extended travel, of using early-make and early-break contacts. It maintains suitability for isolation and offers optional locking using a keylock or a padlock.

Emergency off

In a circuit equipped with a circuit breaker, this function is carried out by an opening mechanism using an MN undervoltage release or an MX shunt release in conjunction with an emergency off button.

Extended rotary handle

Rotary handle with an extended shaft to control devices installed at the rear of switchboards. It has the same characteristics as direct rotary handles. It offers multiple locking possibilities using a keylock, a padlock or a door interlock.

Failsafe remote tripping

Remote tripping is carried out by an opening mechanism using an MN undervoltage release in conjunction with an emergency off button. If power is lost, the protection device opens the circuit breaker.

Manual toggle control

This is the standard control mechanism for the circuit breaker, with a toggle that can be flipped up or down. In a molded-case circuit breaker (MCCB), there are three positions, I (ON), O (OFF) and TRIPPED. Once in the TRIPPED position, manual reset is required by switching to O (OFF position before reclosing. The TRIPPED position does not offer isolation with positive contact indication. This is guaranteed only by the O (OFF) position.

MCC rotary handle

Handle used for motor control centres and providing IP43 and IK07.

Motor mechanism module

The optional motor mechanism module is used to remotely open, close and recharge the circuit breaker.

Selectivity/Cascading

Cascading

Cascading implements the current-limiting capacity of a circuit breaker, making it possible to install downstream circuit breakers with lower performance levels. The upstream circuit breaker reduces any high short-circuit currents. This makes it possible to install downstream circuit breakers with breaking capacities less than the prospective short-circuit current at their point of installation. The main advantage of cascading is to reduce the overall cost of switchgear. Because the current is limited throughout the circuit downstream of the limiting circuit breaker, cascading applies to all the devices located downstream.

Current selectivity

Selectivity based on the difference between the current-protection settings of the circuit breakers. The difference in settings between two successive circuit breakers in a circuit must be sufficient to allow the downstream breaker to clear the fault before the upstream breaker trips.

Selectivity	Selectivity is ensured between upstream and downstream circuit breakers if, when a fault occurs, only the circuit breaker placed immediately upstream of the fault trips. Selectivity is the key to ensuring the continuity of service of an installation.
Energy selectivity	This function is specific to ComPacT NSX (see Reflex tripping on page G-7) and supplements the other types of selectivity.
Partial selectivity	Selectivity is partial if the conditions for total selectivity are not met up to the ultimate short-circuit current I_{cu} , but only up to a lesser value. This value is called the selectivity limit. If a fault exceeds the selectivity limit, both circuit breakers trip.
Time selectivity	Selectivity based on the difference between the time-delay settings of the circuit breakers. The upstream trip unit is delayed to provide the downstream breaker the time required to clear the fault.
Total selectivity	Total selectivity is ensured between upstream and downstream circuit breakers if, for all fault values, from overloads up to solid short-circuits, only the downstream circuit breaker trips and the upstream circuit breaker remains closed.
Zone selective interlocking (ZSI)	<p>A number of circuit breakers with MicroLogic electronic trip units are interconnected one after another by a pilot wire. In the event of a short-time or ground fault:</p> <ul style="list-style-type: none"> ■ In the absence of information from downstream, the circuit breaker directly concerned by the fault (i.e. located just upstream of the fault) shifts to the shortest time delay and sends a signal upstream ■ The upstream device, on receiving the signal from the downstream device, maintains its normal time delay. <p>In this manner, the fault is cleared rapidly by the circuit breaker closest to the fault.</p>

Environment.....

EMC (Electromagnetic compatibility)	EMC is the capacity of a device not to disturb its environment during operation (emitted electromagnetic disturbances) and to operate in a disturbed environment (electromagnetic disturbances affecting the device). The standards define various classes for the types of disturbances. MicroLogic trip units comply with annexes F and J in standard IEC IE60947-2.
Power loss Pole resistance	The flow of current through the circuit-breaker poles produces Joule-effect losses caused by the resistance of the poles.
Product environmental profile (PEP) LCA: Life-cycle assessment ISO 14040	<p>An assessment on the impact of the construction and use of a product on the environment, in compliance with standard ISO 14040, Environmental management, life-cycle assessment (LCA), principles and framework.</p> <p>For ComPacT NSX, this assessment is carried out using the Standardized EIME (Environmental Impact and Management Explorer) software, which makes possible comparisons between the products of different manufacturers.</p> <p>It includes all stages, i.e. manufacture, distribution, use and end of life, with set usage assumptions:</p> <ul style="list-style-type: none"> ■ Use over 20 years at a percent load of 80% for 14 hours per day and 20% for ten hours ■ According to the European electrical-energy model. <p>It provides the information presented below.</p> <ul style="list-style-type: none"> ■ Materials making up the product: composition and proportions, with a check to make sure no substances forbidden by the RoHS directive are included. ■ Manufacture: on Schneider Electric production sites that have set up an environmental management system certified ISO 14001. ■ Distribution: packaging in compliance with the 94/62/EC packaging directive (optimized volumes and weights) and optimized distribution flows via local centres. ■ Use: no aspects requiring special precautions for use. Power lost through Joule effect in Watts (W) must be < 0.02% of total power flowing through the circuit breaker. Based on the above assumptions, annual consumption from 95 to 200 kWh. ■ End of life: products dismantled or crushed. For ComPacT NSX, 81% of materials can be recycled using standard recycling techniques. Less than 2% of total weight requires special recycling.



Glossary

<p>Product environmental profile (PEP) Environmental indicators</p>	<p>Environmental indicators are also frequently used for the PEP (sheet available on request for ComPacT NSX):</p> <ul style="list-style-type: none"> ■ Depletion of natural resources ■ Depletion of energy ■ Depletion of water ■ Potential for atmospheric warming (greenhouse effect) ■ Potential for stratospheric ozone depletion ■ Creation of atmospheric ozone (ozone layer) ■ Acidification of air (acid rain) ■ Production of hazardous waste.
<p>RoHS directive (Restriction of Hazardous substances)</p>	<p>European directive 2002/95/EC dated 27 January 2003 aimed at reducing or eliminating the use of hazardous substances. The manufacturer must attest to compliance, without third-party certification. Circuit breakers are not included in the list of concerned products, which are essentially consumer products. That notwithstanding, Schneider Electric decided to comply with the RoHS directive. ComPacT NSX products are designed in compliance with RoHS and do not contain (above the Authorized levels) lead, mercury, cadmium, hexavalent chromium or flame retardants (polybrominated biphenyls PBB and polybrominated diphenyl ether PBDE).</p>
<p>Safety clearances</p>	<p>When installing a circuit breaker, minimum distances (safety clearances) must be maintained between the device and panels, bars and other protection systems installed nearby. These distances, which depend on the ultimate breaking capacity, are defined by tests carried out in accordance with standard IEC 60947-2.</p>
<p>Temperature derating</p>	<p>An ambient temperature varying significantly from 40°C can modify operation of magnetic or thermal-magnetic protection functions. It does not affect electronic trip units. However, when electronic trip units are used in high-temperature situations, it is necessary to check the settings to ensure that only the permissible current for the given ambient temperature is let through.</p>
<p>Vibration withstand IEC 60068-2-6</p>	<p>Circuit breakers are tested in compliance with standard IEC 60068-2-6 for the levels required by merchant-marine inspection organizations (Veritas, Lloyd's, etc.):</p> <ul style="list-style-type: none"> ■ 2 to 13.2 Hz: amplitude of ±1 mm ■ 13.2 to 100 Hz: constant acceleration of 0.7 g.
<p>WEEE directive (Waste of Electrical and Electronic Equipment)</p>	<p>European directive on managing the waste of electrical and electronic equipment. Circuit breakers are not included in the list of concerned products. However, ComPacT NSX products respect the WEEE directive.</p>

Harmonics.....



<p>Current harmonics</p>	<p>Non-linear loads cause harmonic currents that flow in the 50 Hz (or 60 Hz) distribution system. Total harmonic current is the sum of sinusoidal AC currents for which the rms values can be measured and broken down into:</p> <ul style="list-style-type: none"> ■ The fundamental current at the 50/60 Hz frequency of the distribution system, with an rms value of I_{H_1} ■ Harmonic currents with whole, odd multiples (3, 5, 7, etc.) of the 50/60 Hz frequency, called the third-order, fifth-order, etc. harmonics. For example, I_{H_3}, the third-order harmonic at 150/180 Hz, I_{H_5}, the fifth-order harmonic at 250/300 Hz, etc. <p>The presence of harmonics in the system must be monitored and limited because it results in temperature rise, currents in the neutral (caused by the third-order harmonics and multiples), malfunctions of sensitive electronic devices, etc. MicroLogic E trip units take into account harmonics up to order 15 in the THDI and THDU calculations.</p>
<p>Non-linear load</p>	<p>Systems producing harmonics are present in all industrial, commercial and residential sectors. Harmonics are caused by non-linear loads. A load is said to be non-linear when the current drawn does not have the same waveform as the supply voltage. Typically, loads using power electronics are non-linear. Examples of non-linear loads include computers, rectifiers, variable-speed drives, arc furnaces and fluorescent lighting.</p>
<p>Total harmonic distortion of current (THDI)</p>	<p>THDI characterizes the distortion of the current wave by harmonics. It indicates the quantity of harmonics in the resulting waveform. It is expressed in percent. The higher the THDI, the more the current is distorted by harmonics. THDI should remain below 10%. Above that level, there is said to be harmonic pollution that is considered severe when it rises above 50%.</p>

Total harmonic distortion of voltage (THDU)	THDU characterizes the distortion of the voltage wave by harmonics. It indicates the quantity of harmonics in the resulting waveform. It is expressed in percent. The higher the THDU, the more the system voltage is distorted by harmonics. It is advised not to exceed 5% for low-voltage systems.
Voltage harmonics	For each current harmonic I_{Hk} , there is a voltage harmonic U_{Hk} of the same order k , where the resulting voltage is the sum of the two waves. The voltage wave is therefore distorted with respect to the standard sinusoidal wave.

Measurements

Contact wear	Each time ComPacT NSX opens, the MicroLogic 5/6 trip unit measures the interrupted current and increments the contact-wear indicator as a function of the interrupted current, according to test results stored in memory.
Current transformer with iron-core toroid	It is made up of a coil wound around an iron frame through which a power busbar runs. The current flowing in the bar, on passing through the sensor, induces a magnetic field that reverses for each half period. This variation in the field in turn creates an induced current in the coil. This current is proportional to the current flowing in the bar. It is sufficient to supply the measurement electronics. The disadvantage of iron-core measurement current transformers (CT) is that they rapidly saturate for currents > 10 In.
Current transformer with Rogowski toroid or air-core CT	It is made up of a coil without an iron frame, through which a power busbar runs. The output voltage at the coil terminals is proportional to the current flowing through the bar. The result is a current transformer (CT) with a voltage output. The advantage is that it never saturates whatever the primary current and thus enables measurement of high currents. The output is however a very low current that is too low to supply the measurement electronics. For MicroLogic, Rogowski CTs measure the current and a second CT, with an iron core, provides the electrical supply.
Demand current, demand power and peak values	Average of the instantaneous current or power values over an adjustable fixed or sliding time interval. The highest value observed over the time interval is the peak value. The time interval runs from the last reset.
Instantaneous current	True rms value of the current measured by the current transformers over a sliding time interval. Available on MicroLogic 5/6 E.
Instantaneous voltage	True rms value of the voltage measured by the voltage sensors over a sliding time interval. Available on MicroLogic 5/6 E.
Maximeters/minimeters	MicroLogic 5 and 6 E can record the minimum and maximum values of electrical parameters over set time periods.
Overvoltage category (OVC - Overvoltage category) IEC 60947-1. Annex H	Standard IEC 60664-1 stipulates that it is up to the user to select a measurement device with a sufficient overvoltage category, depending on the network voltage and the transient overvoltages likely to occur. Four overvoltage categories define the field of use for a device. <ul style="list-style-type: none"> ■ Cat. I. Devices supplied by a SELV isolating transformer or a battery. ■ Cat. II. Residential distribution, handheld or laboratory tools and devices connected to Standardized 2P + earth electrical outlets (230 V). ■ Cat. III. Industrial distribution, fixed distribution circuits in buildings (main low voltage switchboards, rising mains, elevators, etc.). ■ Cat. IV. Utility substations, overhead lines, certain industrial equipment.
Percent load	Percentage of current flowing through the circuit breaker with respect to its rated current. MicroLogic 6 E-M offers this information and can sum it over the total operating time to provide the load profile for the following ranges, 0 to 49%, 50 to 79%, 80 to 89% and $\geq 90\%$.
Phase sequence	The order in which the phases are connected (L1, L2, L3 or L1, L3, L2) determines the direction of rotation for three-phase asynchronous motors. MicroLogic 6 E-M trip units provide this information.
Power and energy metering (consumption)	The digital electronics in MicroLogic 5/6 E calculate the instantaneous power levels, apparent (S in kVA), active (P in kW) and (Q in kV), and integrate over a time interval to determine the corresponding energies (kVAh, kWh kvarh). Calculations are for each phase and for the total.

Glossary

Time-stamped histories

MicroLogic trip units store information on events (e.g. alarms and their cause) that are time-stamped to within a millisecond.

Protection

Ground-fault protection G (Ig)

Protection function specific to electronic circuit breakers, symbolized by G (Ground). This protection can calculate high-threshold residual earth-leakage currents (in the order of tens of Amperes) on the basis of phase-current measurements. MicroLogic 5/6 offers this protection function with adjustable pick-up Ig and time delay.

Instantaneous protection I (Ii)

This protection supplements I_{sd}. It provokes instantaneous opening of the device. The pick-up may be adjustable or fixed (built-in). This value is always lower than the contact-repulsion level.

Long-time protection L (I_r)

Protection function where the adjustable I_r pick-up determines a protection curve similar to the thermal-protection curve (inverse-time curve I²t). The curve is generally determined on the basis of the I_r setting which corresponds to a theoretically infinite tripping time (asymptote) and of the point at 6 I_r at which the tripping time depends on the rating.

Magnetic protection (Ii)

Short-circuit protection provided by magnetic trip units (see this term). The pick-up setting may be fixed or adjustable.

Neutral protection (IN)

The neutral is protected because all circuit-breaker poles are interrupted. The setting may be that used for the phases or specific to the neutral, i.e. reduced neutral (0.5 times the phase current) or OSN (oversized neutral) at 1.6 times the phase current. For OSN protection, the maximum device setting is limited to 0.63 I_n.

Residual-current earth-leakage protection (IΔn)

Protection provided by VigiPacT add-on, in which the residual-current toroids directly detect low-threshold earth-leakage currents (in the order of tens of mA) caused by insulation faults.

Short-delay protection S (I_{sd})

Protection function specific to electronic circuit breakers, symbolized by S (Short delay or short time). This protection supplements thermal protection. The reaction time is very short, but has a slight time delay to enable selectivity with the upstream device. The short-delay pick-up I_{sd} is adjustable from approximately 1.5 to 10 I_r.

Short-delay protection with fixed time delay S_o (I_{sd})

Short-delay protection, but with a fixed time delay. This function is available on MicroLogic 2. It is symbolized by S_o. It ensures selectivity with downstream devices.

Thermal protection (I_r)

Overload protection provided by thermal trip units (see this term) using an inverse-time curve (I²t).

Relays and auxiliary contacts

Auxiliary contact IEC 60947-1

Contact included in an auxiliary circuit and mechanically operated by the switching device.

Break contact IEC 60947-1

Control or auxiliary contact which is open when the main contacts of the mechanical switching device are closed and closed when they are open.

Make contact IEC 60947-1

Control or auxiliary contact which is closed when the main contacts of the mechanical switching device are closed and open when they are open.

Relay (electrical) IEC 60947-1

Device designed to produce sudden, predetermined changes in one or more electrical output circuits when certain conditions are fulfilled in the electrical input circuits controlling the device.

Relay module with static output

Output of a relay made up of a thyristor or triac electronic component. The low interrupting capacity means that a power relay is required. This is the case for the SDx and SDTAM outputs.

Switchgear

Circuit breaker
IEC 60947-2



Mechanical switching device, capable of making, carrying and breaking currents under normal circuit conditions and also making, carrying for a specified time and breaking currents under specified abnormal circuit conditions such as those of short circuit. Circuit breakers are the device of choice for protection against overloads and short-circuits. Circuit breakers may, as is the case for ComPacT NSX, be suitable for isolation.

Circuit-breaker utilization category
IEC 60947-2

The standard defines two utilization categories, A and B, depending on breaker selectivity with upstream breakers under short-circuit conditions.

- Category A. Circuit breakers not specifically designed for selectivity applications.
- Category B. Circuit breakers specifically designed for selectivity, which requires a short time-delay (which may be adjustable) and a rated short-time withstand current in compliance with the standard.

ComPacT NSX 100 to 630 circuit breakers are category A, however, by design, they provide selectivity with downstream devices (see the Selectivity, Cascading and Coordination Guide).

Contactors
IEC 60947-1



Mechanical switching device having only one position of rest, operated otherwise than by hand, capable of making, carrying and breaking currents under normal circuit conditions including operating overload conditions. A contactor is provided for frequent opening and closing of circuits under load or slight overload conditions. It must be combined and coordinated with a protective device against overloads and short-circuits, such as a circuit breaker.

Contactors utilization categories
IEC 60947-4-1

The standard defines four utilization categories, AC1, AC2, AC3 and AC4 depending on the load and the control functions provided by the contactor. The class depends on the current, voltage and power factor, as well as contactor withstand capacity in terms of frequency of operation and endurance.

Current-limiting circuit breaker
IEC 60947-2

A circuit-breaker with a break-time short enough to prevent the short-circuit current reaching its otherwise attainable peak value.

Disconnectors
IEC 60947-3

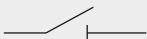

Mechanical switching device which, in the open position, complies with the requirements specified for the isolating function. A disconnector serves to isolate upstream and downstream circuits. It is used to open or close circuits under no-load conditions or with a negligible current level. It can carry the rated circuit current and, for a specified time, the short-circuit current.

Switch-disconnectors
IEC 60947-3

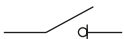

Switch which, in the open position, satisfies the isolating requirements specified for a disconnector. A switch-disconnector serves for switching and isolation. The switch function breaks the circuit under load conditions and the disconnection function isolates the circuit. Protection is not provided. It may be capable of making short-circuit currents if it has the necessary making capacity, but it cannot break short-circuit currents. ComPacT NSX 100 to 630 NA switch-disconnectors have a making capacity.

Switch-disconnector utilization category
IEC 60947-3

The standard defines six utilization categories, AC-21A or B, AC-22 A or B, AC23 A or B. They depend on the rated operational current and the mechanical durability (A for frequent operation or B for infrequent operation). ComPacT NSX NA switch-disconnectors comply with utilization categories AC22A or AC23A.



Three-phase asynchronous motors and their protection

Locked-rotor protection (Ijam)

This function steps in when the motor shaft cannot or can no longer drive the load. The result is a high overcurrent.

Long-start protection (Ilong)

An overly long start means the current drawn remains too high or too low for too long, with respect to the starting current. In all cases, the load cannot be driven and the start must be interrupted. The resulting temperature rise must be taken into account before restarting.

Phase-unbalance or phase- loss protection (Iunbal)

This protection function steps in if the current values and/or the unbalance in the three phases supplying the motor exceeds tolerances. Currents should be equal and displacement should be one third of a period. Phase loss is a special case of phase unbalance.

Glossary

Starting current	Start-up of a three-phase, asynchronous motor is characterized by: <ul style="list-style-type: none"> ■ A high inrush current, approximately 14 I_n for 10 to 15 ms ■ A starting current, approximately 7.2 I_n for 5 to 30 seconds ■ Return to the rated current after the starting time.
Starting time	Time after which the motor ceases to draw the starting current and falls back to the operating current I _r (≤ I _n).
Thermal image of the rotor and stator	The thermal image models the thermal behaviour of a motor rotor and stator, taking into account temperature rise caused by overloads or successive starts, and the cooling constants. For each motor power rating, the algorithm takes into account a theoretical amount of iron and copper which modifies the cooling constants.
Thermal protection	Protection against overcurrents following an inverse time curve I ² t = constant, which defines the maximum permissible temperature rise for the motor. Tripping occurs after a time delay that decreases with increasing current.
Trip class IEC 60947-4-1	The trip class determines the trip curve of the thermal protection device for a motor feeder. The standard defines trip classes 5, 10, 20 and 30. These classes are the maximum durations, in seconds, for motor starting with a starting current of 7.2 I _r , where I _r is the thermal setting indicated on the motor rating plate.
Under-load protection (Iund)	This function steps in when the driven load is too low. It detects a set minimum phase current which signals incorrect operation of the driven machine. In the example of a pump, under-load protection detects when the pump is no longer primed.

Trip units

Electronic trip unit (MicroLogic)	Trip unit that continuously measures the current flowing through each phase and the neutral if it exists. For MicroLogic, the measurements are provided by built-in current sensors linked to an analog-digital converter with a high sampling frequency. The measurement values are continuously compared by the ASIC to the protection settings. If a setting is overrun, a Mitop release trips the circuit-breaker operating mechanism. This type of trip unit offers much better pick-up and delay setting accuracy than thermal-magnetic trip units. It also provides a wider range of protection functions.
Magnetic release	Release actuated by a coil or a lever. A major increase in the current (e.g. a short-circuit) produces in the coil or the lever a change in the magnetic field that moves a core. This trips the circuit breaker operating mechanism. Action is instantaneous. The pick-up setting may be adjustable.
Reflex tripping	ComPacT NSX circuit breakers have a patented reflex-tripping system based on the energy of the arc and that is independent of the other protection functions. It operates extremely fast, before the other protection functions. It is an additional safety function that operates before the others in the event of a very high short-circuit.
Release IEC 60947-1	Device, mechanically connected to a mechanical switching device (e.g. a circuit breaker), which releases the holding means and permits the opening or the closing of the switching device. For circuit breakers, releases are often integrated in a trip unit.
Shunt release (MX)	This type of release operates when supplied with current. The MX release provokes circuit-breaker opening when it receives a pulse-type or maintained command.
Thermal-magnetic trip unit	Trip unit combining thermal protection for overloads and magnetic protection.
Thermal release	Release in which a bimetal strip is heated by the Joule effect. Above a temperature-rise threshold that is a function of the current and its duration (I ² t curve = constant, which is representative of temperature rise in cables), the bimetal strip bends and releases the circuit-breaker opening mechanism. The pick-up setting may be adjustable.
Undervoltage release (MN)	This type of release operates when the supply voltage drops below the set minimum.



Additional Characteristics

ComPacT NSXm up to 160 A

TMD Magnetic Trip Units, Tripping Curves	
Protection of Distribution Systems	H-2
MicroLogic Vigi 4.1, Tripping Curves	
Protection of Distribution Systems	H-4

ComPacT NSX100 to 250

TMD Magnetic Trip Units, Tripping Curves	
Protection of Distribution Systems	H-5
MicroLogic 2.2, 4.2 and 2.2 G Electronic Trip Units, Tripping Curves, Protection of Distribution Systems	H-11
MicroLogic 5.2 and 6.2 E and 7.2 E Electronic Trip Units, Tripping Curves - Protection of Distribution Systems	H-12
MA Magnetic Trip Units, MicroLogic 2.2 M Electronic Trip Units, Tripping Curves - Motor Protection.....	H-13
MicroLogic 6.2 E-M Electronic Trip Units, Tripping Curves Motor Protection.....	H-14

ComPacT NSX400 to 630

MicroLogic 2.3, 4.3, 5.3 and 6.3 E and 7.3 E Electronic Trip Units, Tripping Curves - Protection of Distribution Systems ..	H-15
MicroLogic 6.3 E and 7.3 E Electronic Trip Units, Tripping Curves - Protection of Distribution Systems	H-16
MicroLogic 1.3 M and 2.3 M Electronic Trip Units, Tripping Curves Motor Protection.....	H-17
MicroLogic 6.3 E-M Electronic Trip Units, Tripping Curves Motor Protection.....	H-18

Tripping Curves ComPacT NSXm and NSX..... H-19

Current and Energy Limiting Curves H-20

ComPacT NSXm	H-21
ComPacT NSX	H-22

Other chapters

Select Circuit Breakers and Switch-Disconnectors	A-1
Select Protection	B-1
Customize Circuit Breakers with Accessories.....	C-1
Smart Panel Integration	D-1
Switchboard Integration.....	E-1
Catalog Numbers	F-1
Glossary	G-1



ComPacT NSXm up to 160 A

TMD Magnetic Trip Units, Tripping Curves

Protection of Distribution Systems

TM16D

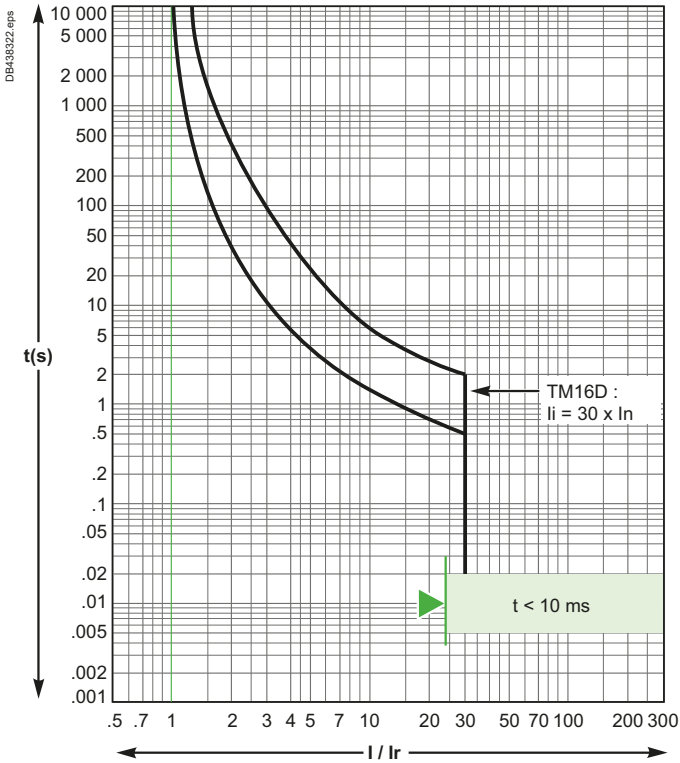

TM25D

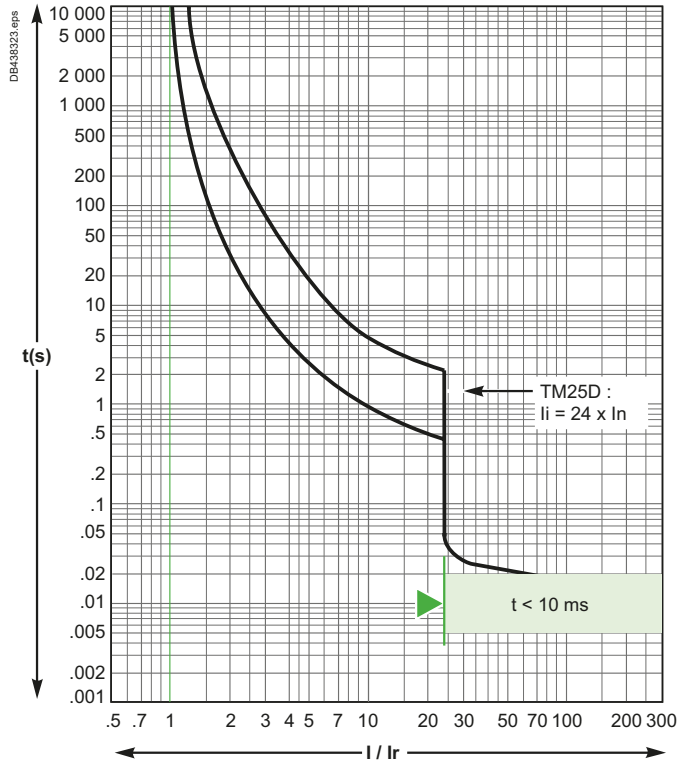

Reflex tripping.

TM32D/TM40D

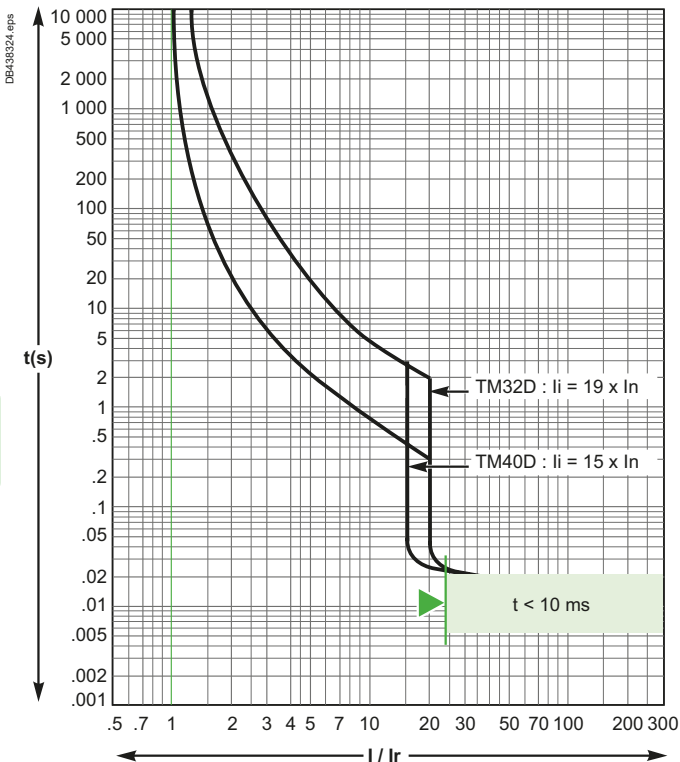

TM50D/TM63D

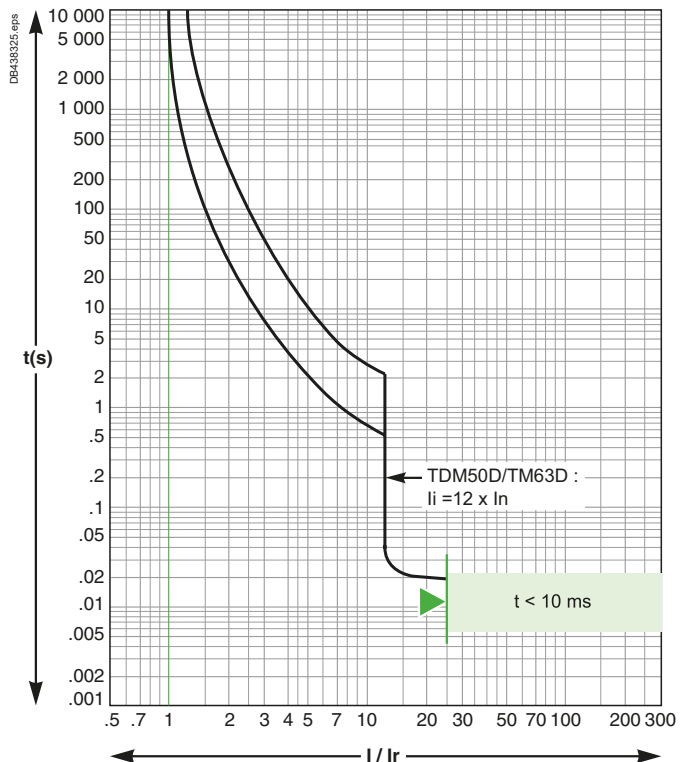

Reflex tripping.

H

ComPacT NSXm up to 160 A

TMD Magnetic Trip Units, Tripping Curves

Protection of Distribution Systems

TM80D/TM100D

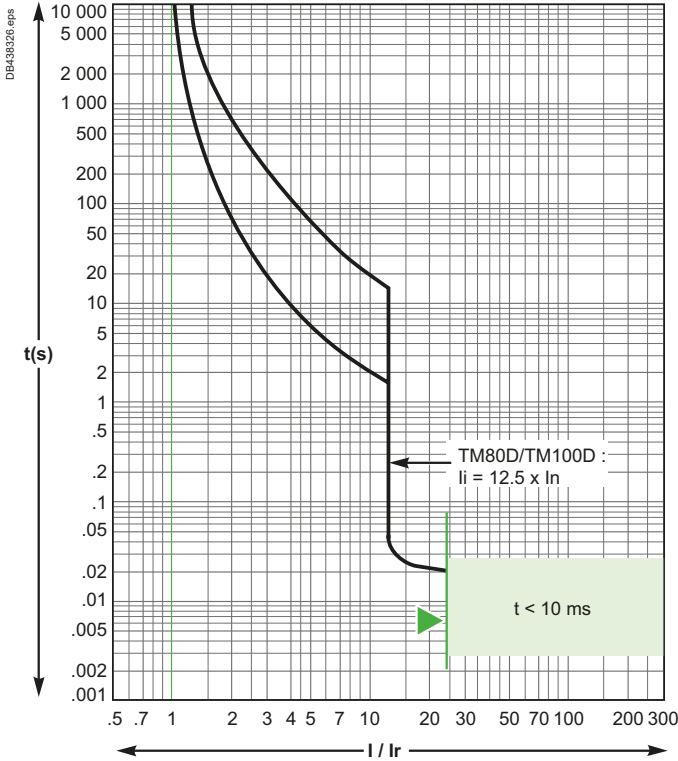

TM125D/TM160D

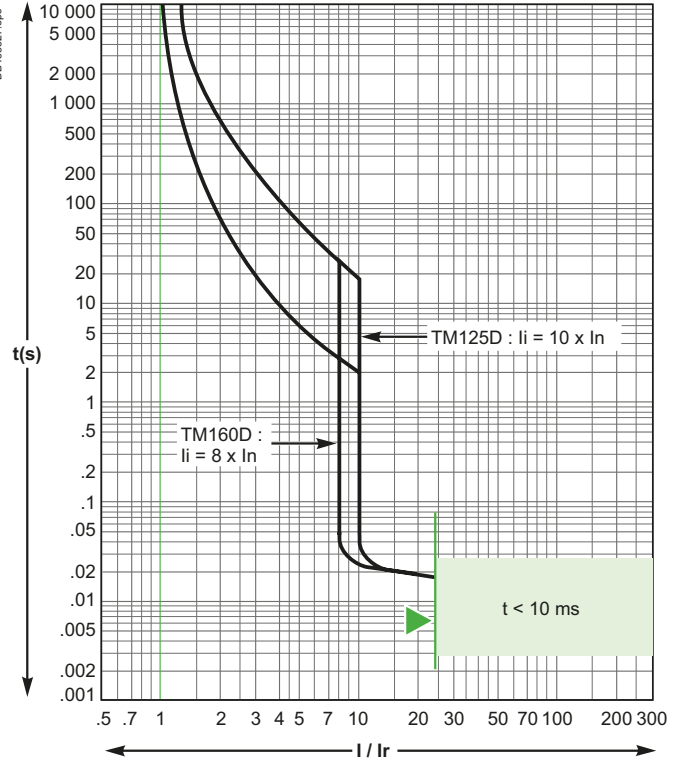

Reflex tripping.

For all TMD curves:
 Values are given for 40 °C ambient, $I_r = 1 \times I_n$, 3 poles loaded, cold start.
 For $I_r = k \times I_n$, read the time corresponding to $1/k$ times given current.
 For 1 pole tripping, read the time corresponding to 0.85 times given current.
 For hot start ($0.9 \times I_r$), divide max. time by 2, min. time by 4.



ComPacT NSXm up to 160 A

MicroLogic Vigi 4.1, Tripping Curves

Protection of Distribution Systems

25 A

50 A

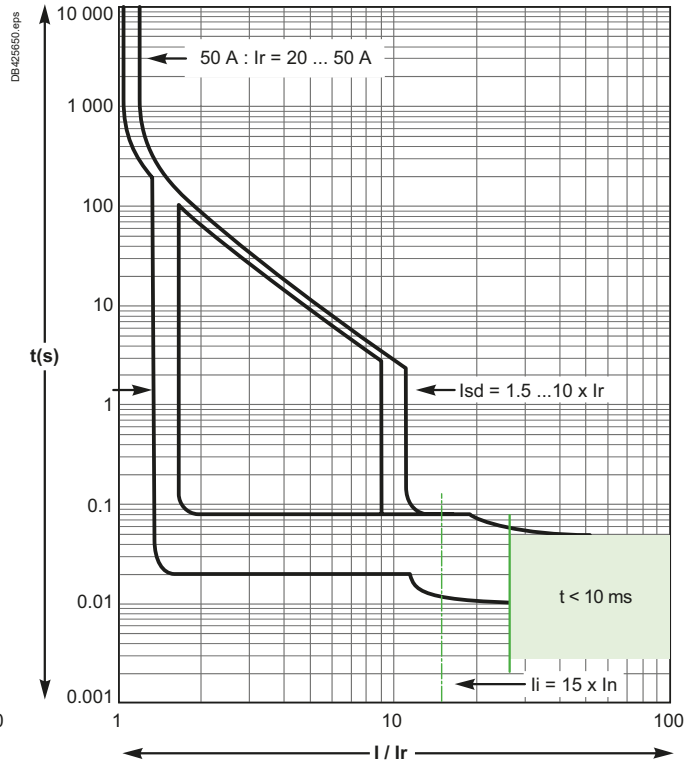
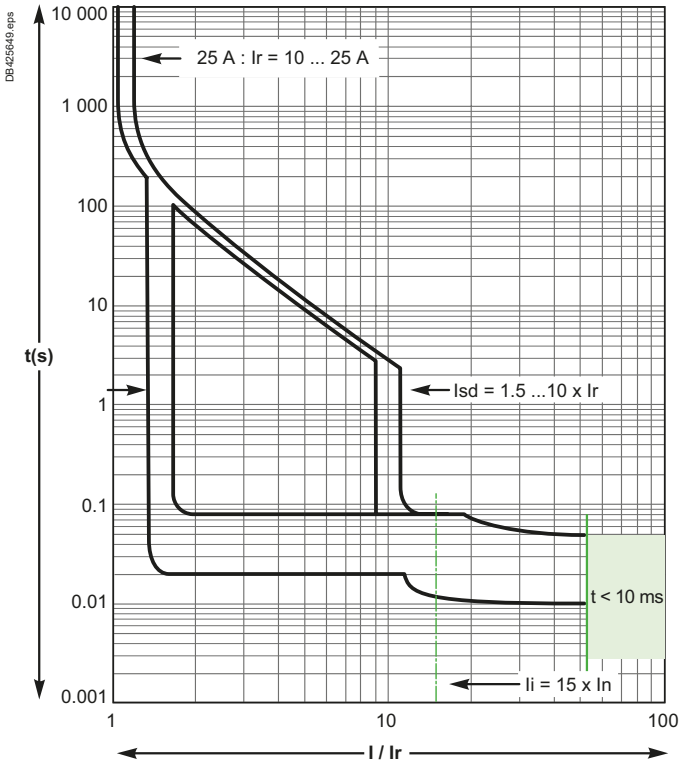

100 A

160 A

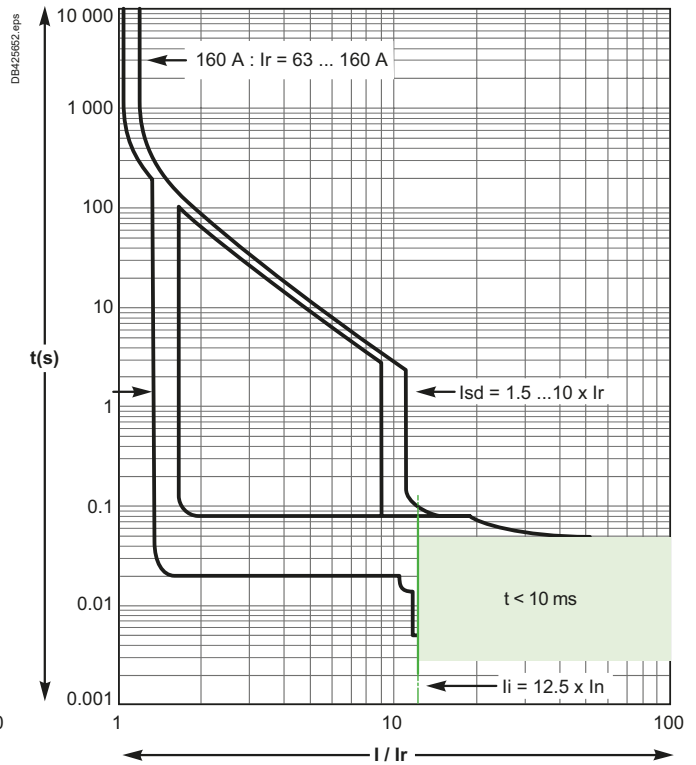
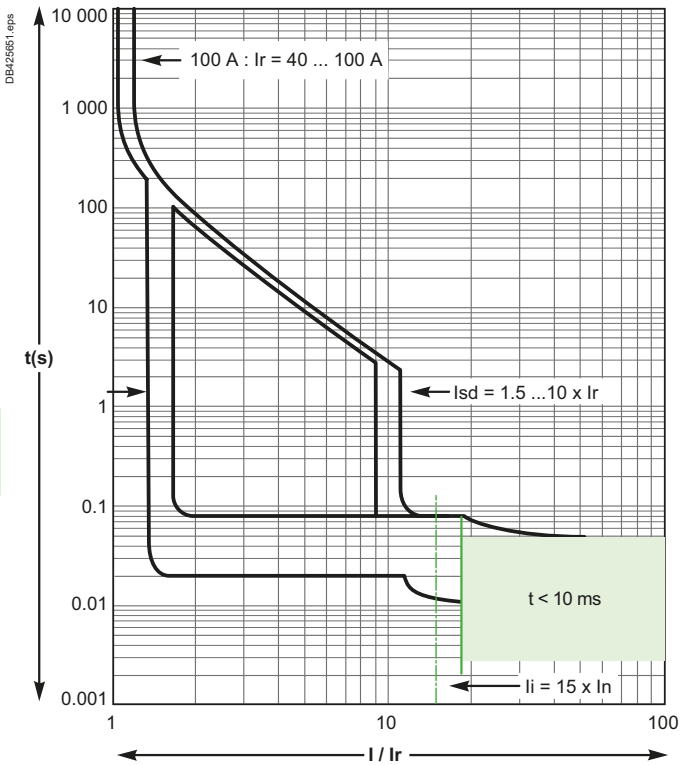

Reflex tripping.



ComPacT NSX100 to 250 TMD Magnetic Trip Units, Tripping Curves Protection of Distribution Systems

TM16D

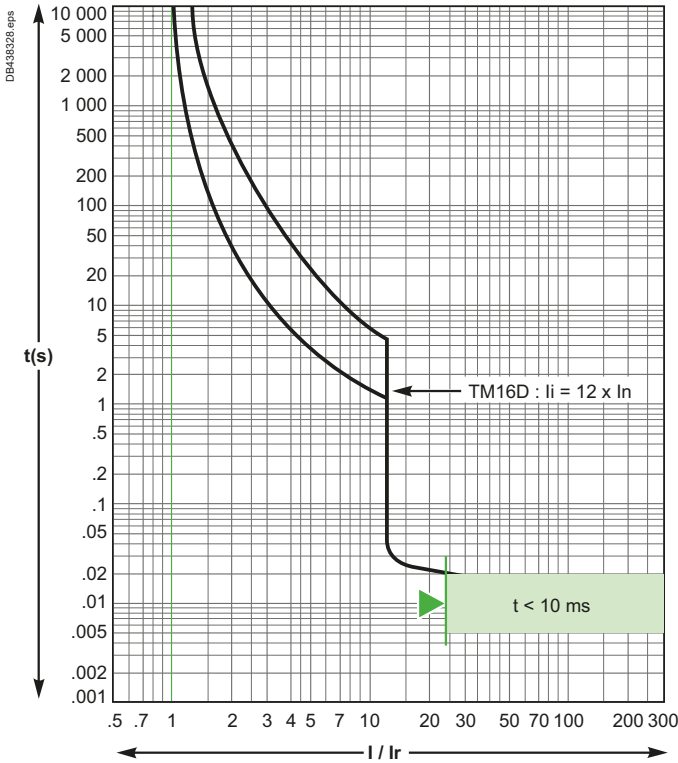

TM25D

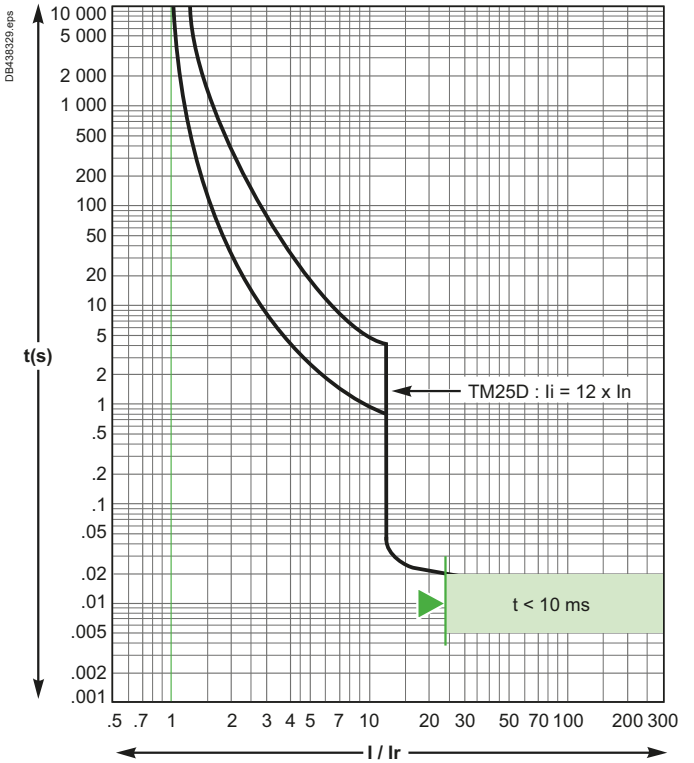

Reflex tripping.

TM30D/TM32D

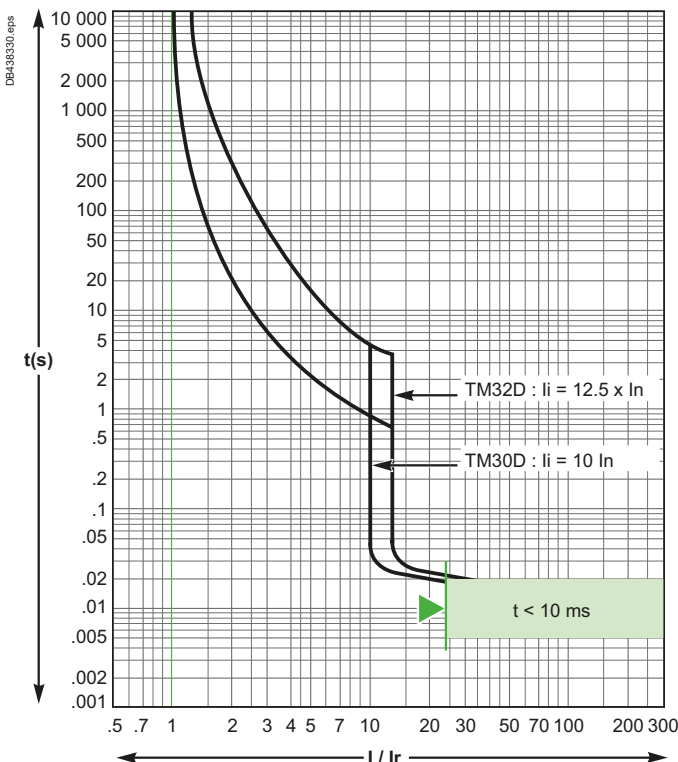

TM40D

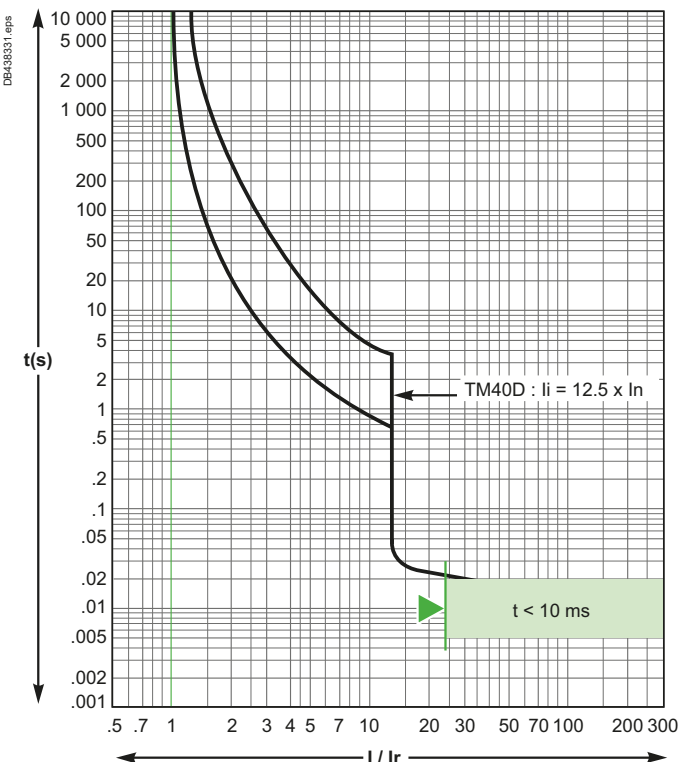

Reflex tripping.



ComPacT NSX100 to 250

TMD Magnetic Trip Units, Tripping Curves

Protection of Distribution Systems

TM50D

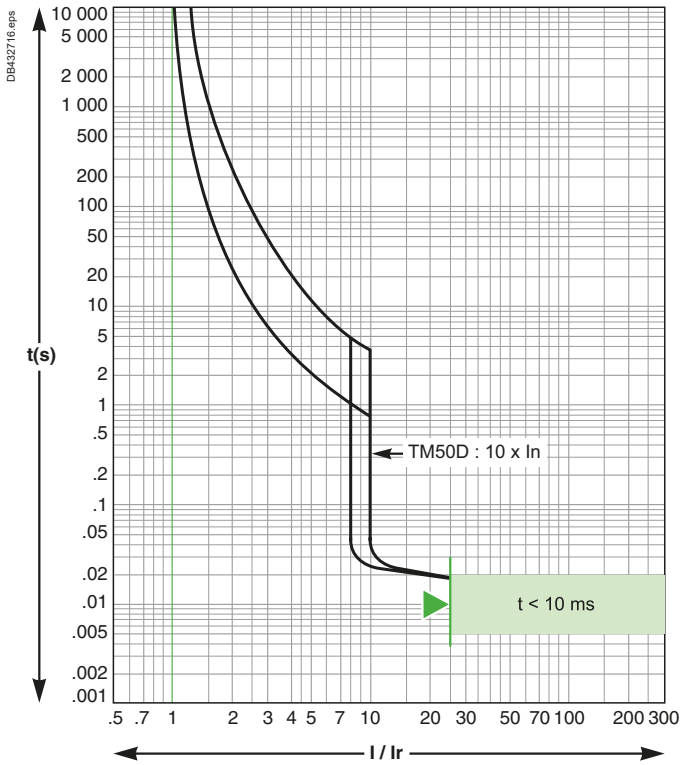

TM63D

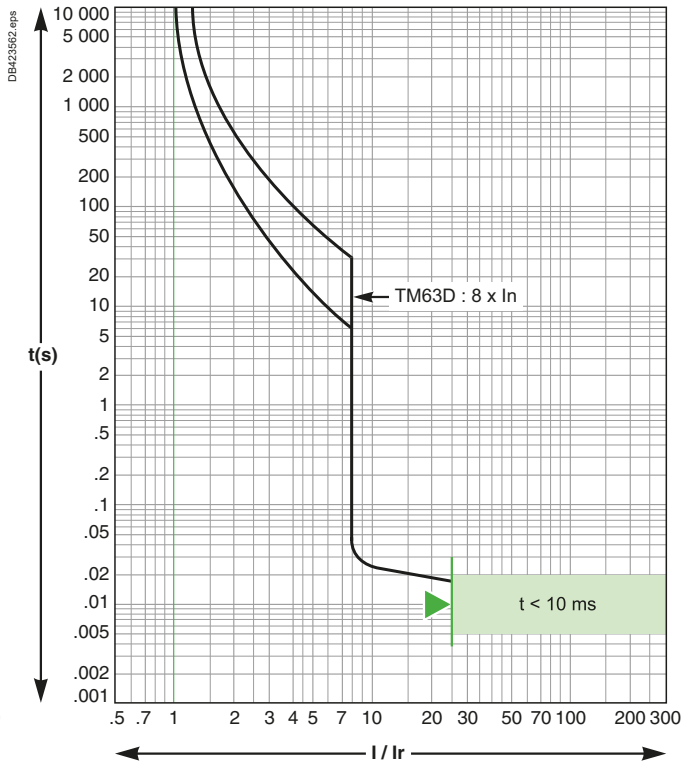

Reflex tripping.

TM80D/TM100D

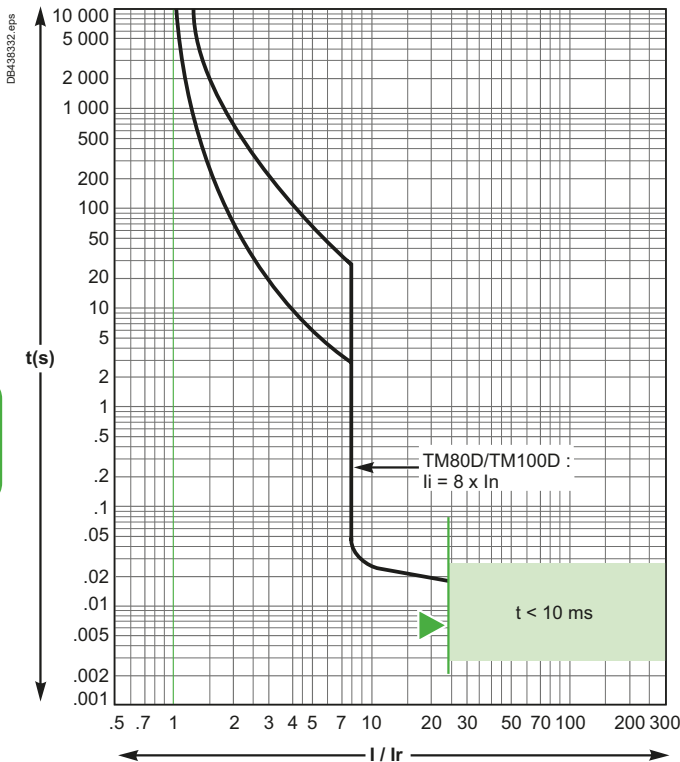

TM125D/TM160D

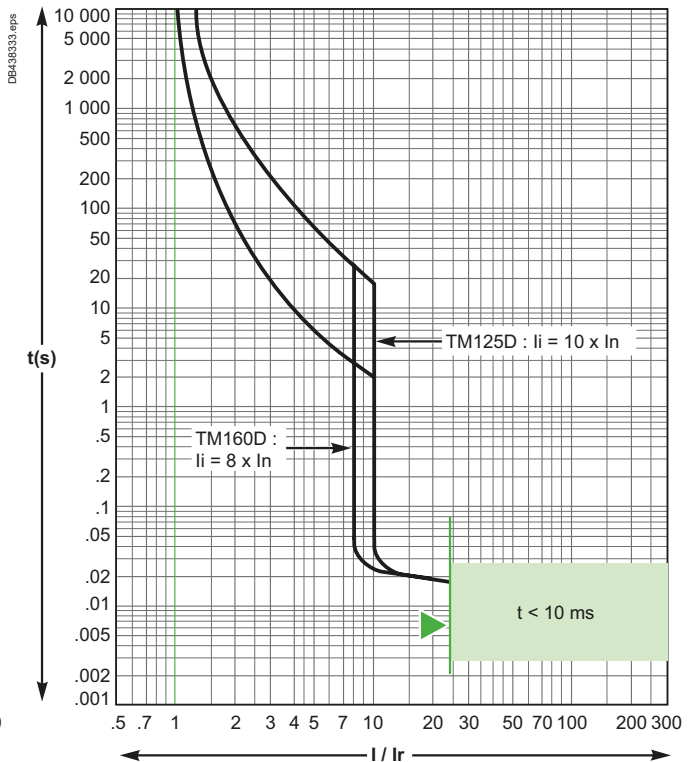

Reflex tripping.



Additional Characteristics

ComPacT NSX100 to 250

TMD Magnetic Trip Units, Tripping Curves

Protection of Distribution Systems

TM200D/TM250D

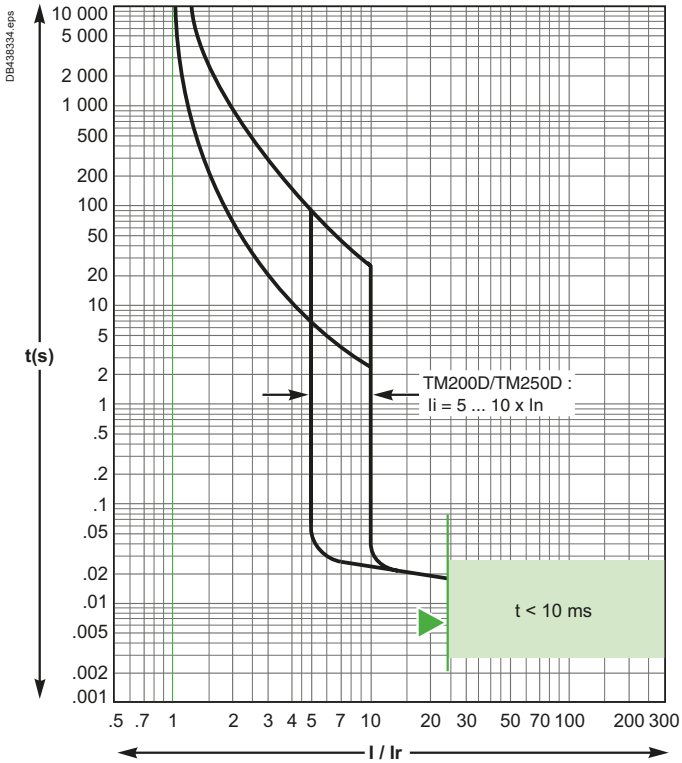

Reflex tripping.

For all TMD Curves:

Values are given for 40 °C ambient, Ir = 1xIn, 3 poles loaded, cold start.

For Ir = k x In, read the time corresponding to 1/k times given current.

For 1 pole tripping, read the time corresponding to 0.85 times given current.

For hot start (0.9 x Ir), divide max. time by 2, min. time by 4.

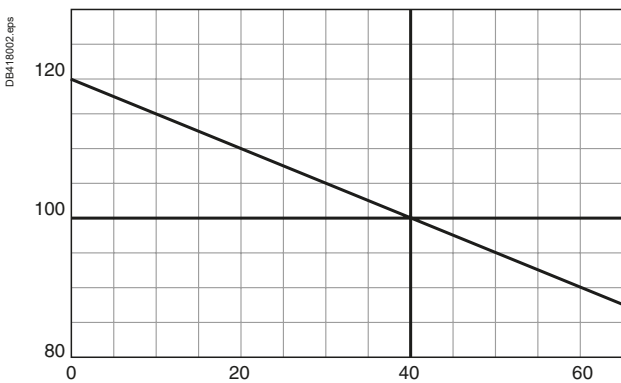

ComPacT NSX100 to 250

TMG Magnetic Trip Units, Tripping Curves

Protection of Distribution Systems

TM16G

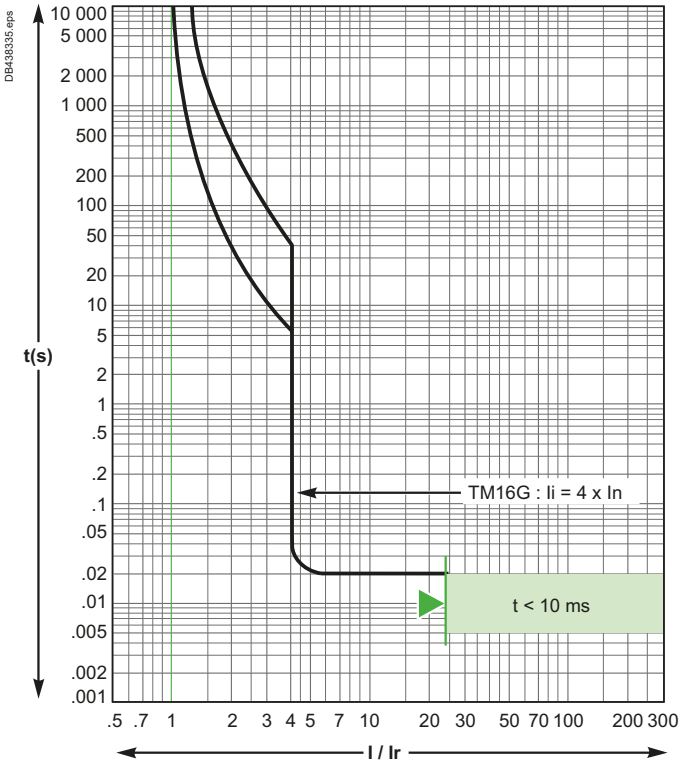

Reflex tripping.

TM25G

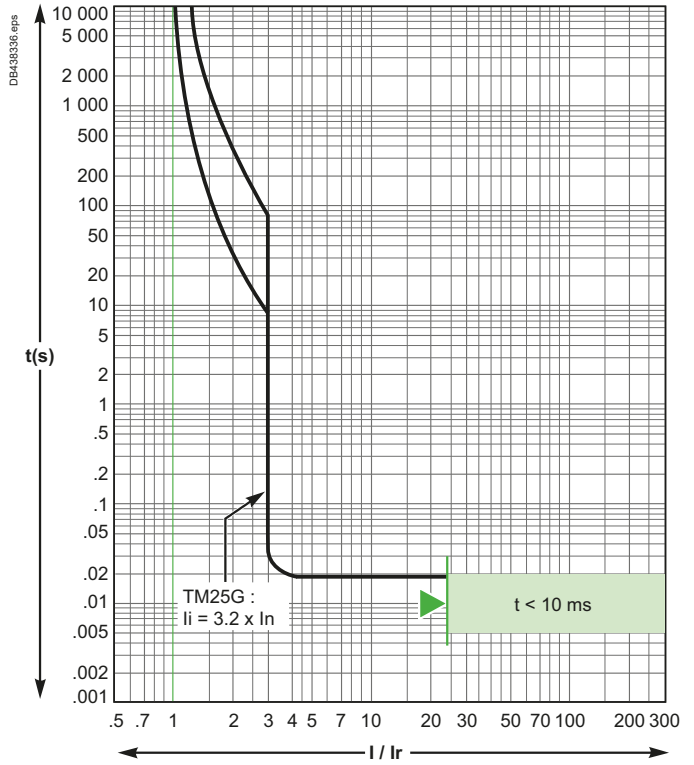

TM40G

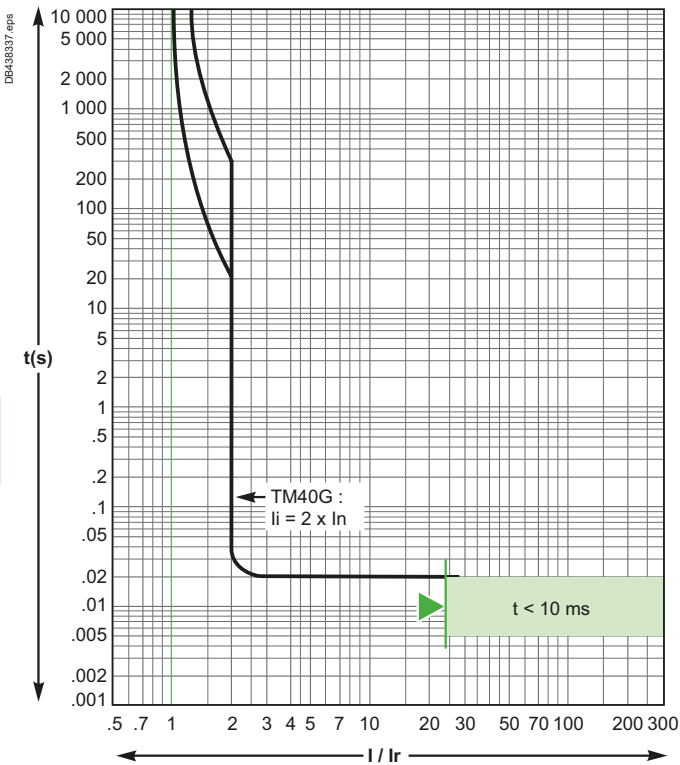

Reflex tripping.

TM63G

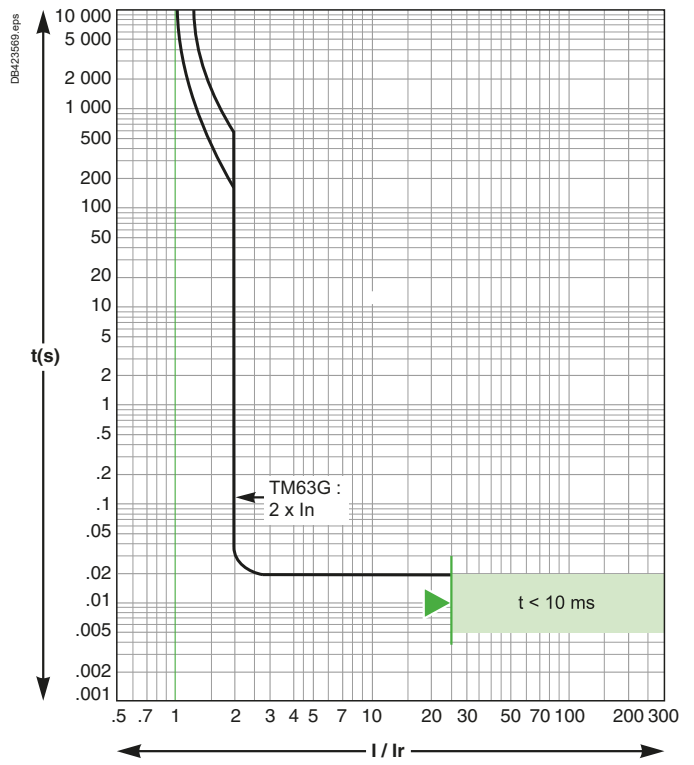

ComPacT NSX100 to 250 TMG Magnetic Trip Units, Tripping Curves Protection of Distribution Systems

TM80G

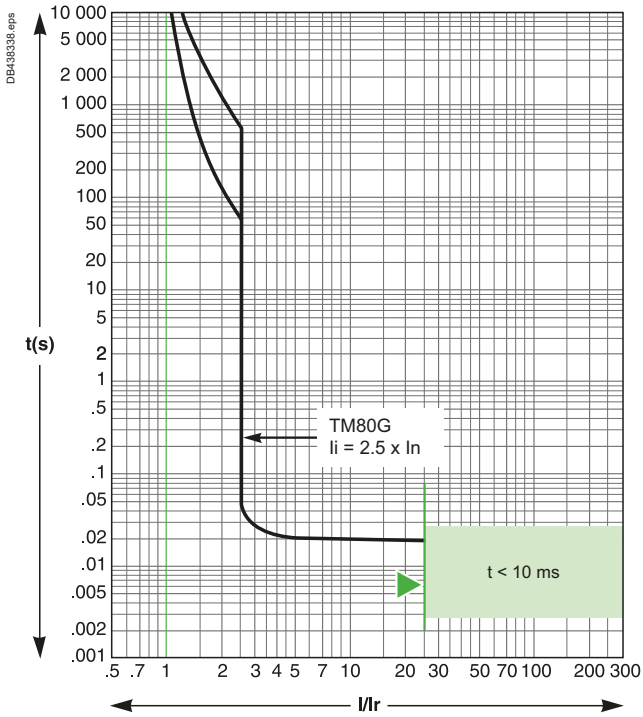

TM100G

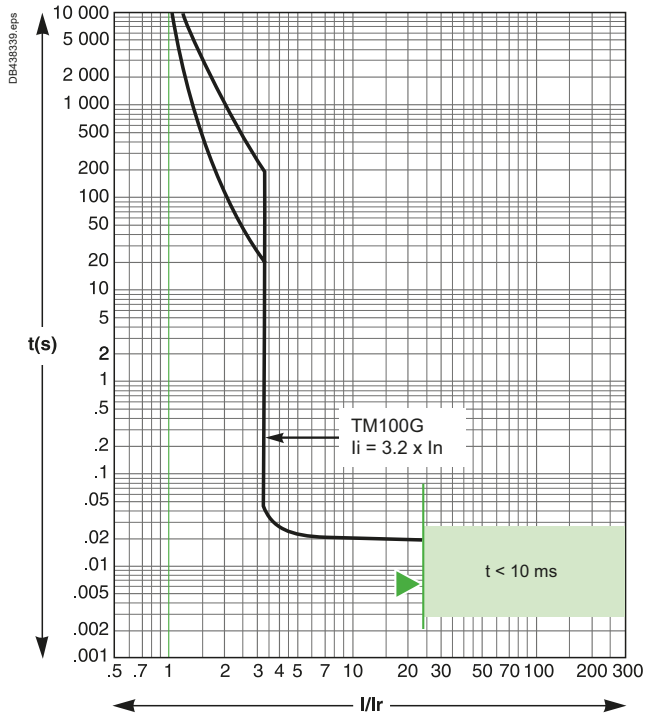

Reflex tripping.

TM125G

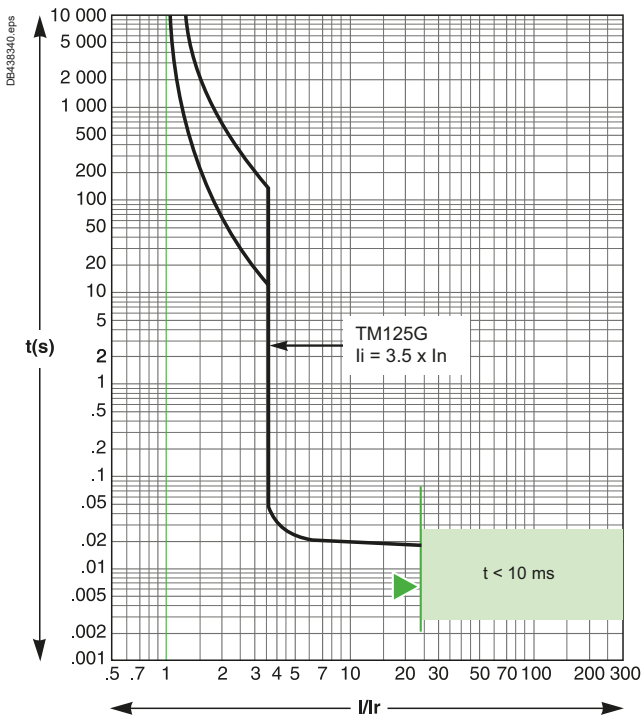

TM160G

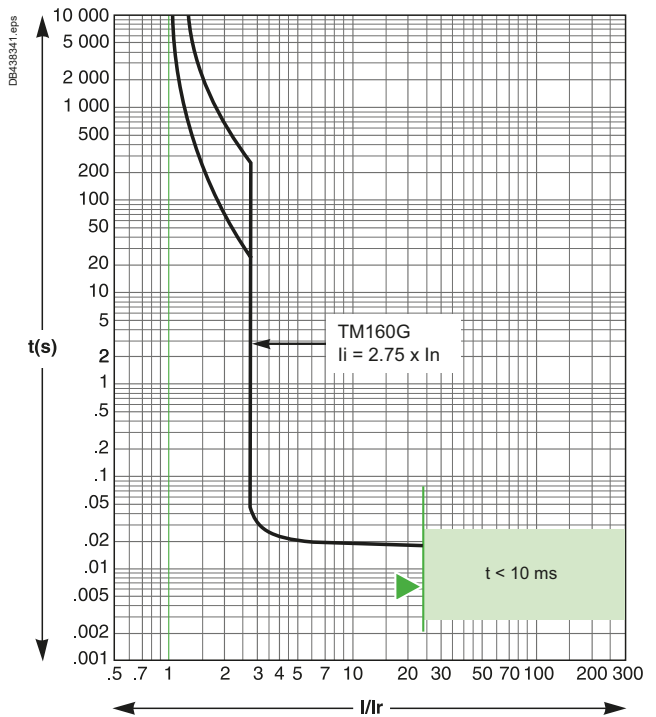

Reflex tripping.



Additional Characteristics

ComPacT NSX100 to 250

TMG Magnetic Trip Units, Tripping Curves

Protection of Distribution Systems

TM200G

TM250G

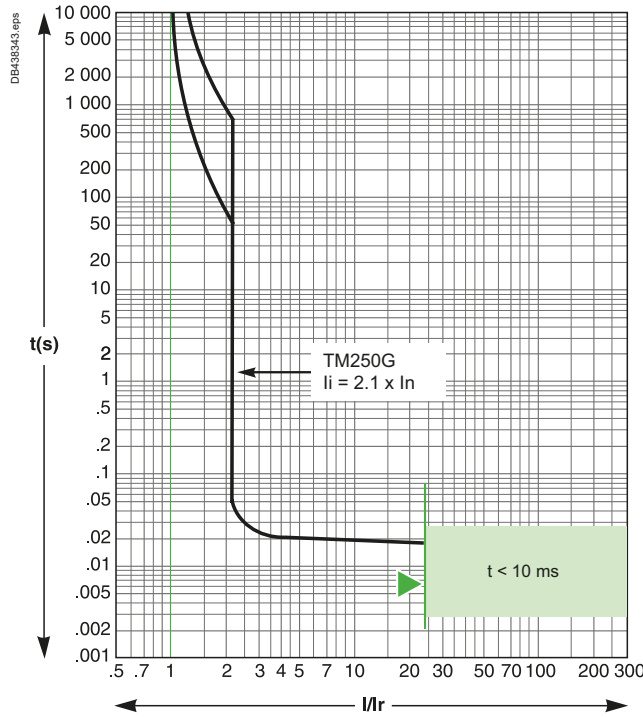
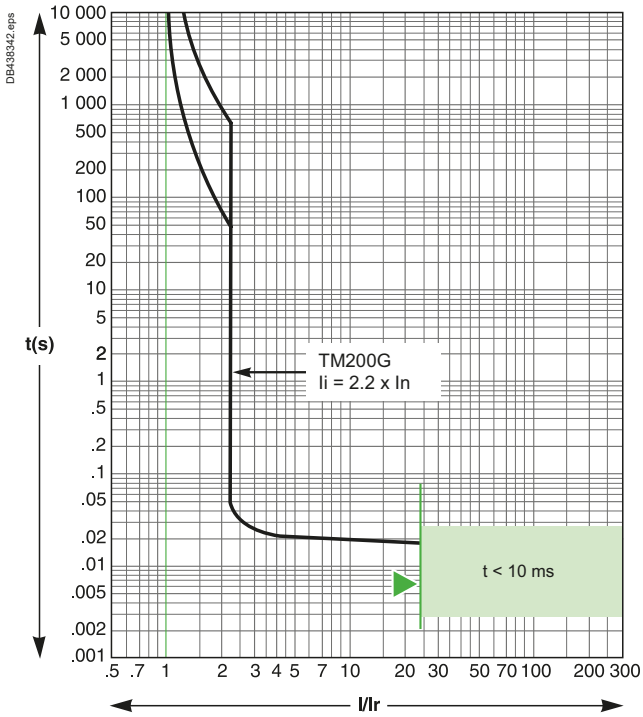

Reflex tripping.



ComPacT NSX100 to 250

MicroLogic 2.2, 4.2 and 2.2 G Electronic Trip Units, Tripping Curves, Protection of Distribution Systems

MicroLogic 2.2, 4.2 - 40... 160 A

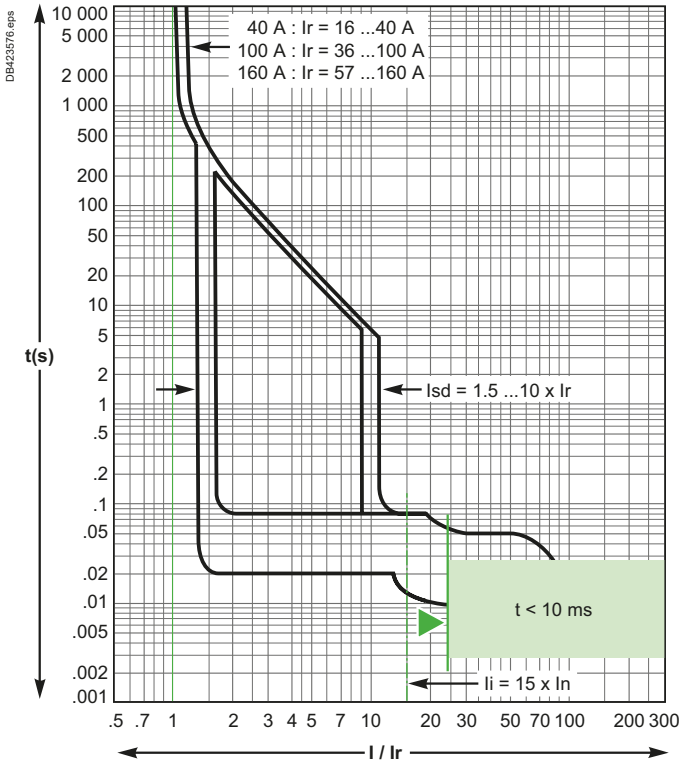

MicroLogic 2.2, 4.2 - 250 A

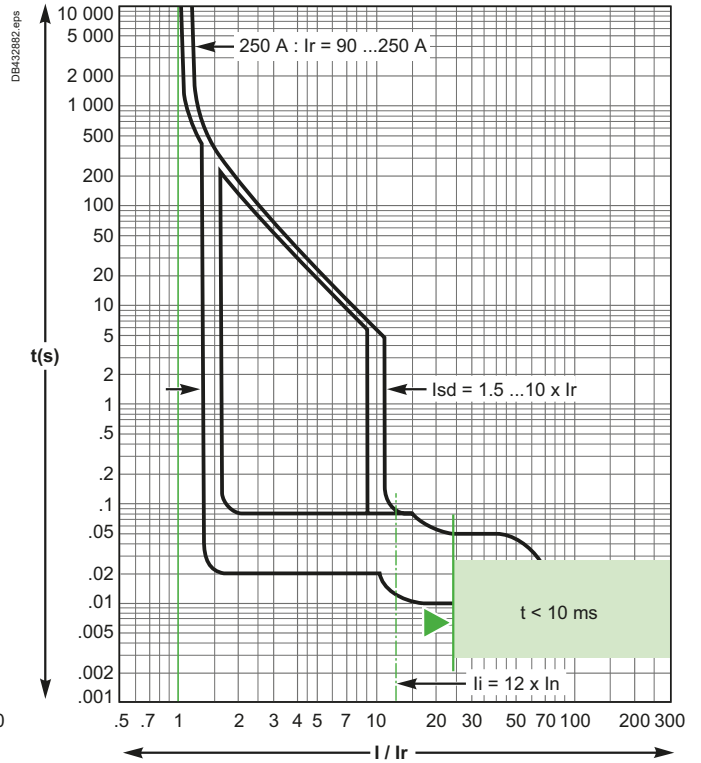

Reflex tripping.

MicroLogic 2.2 G - 40... 160 A

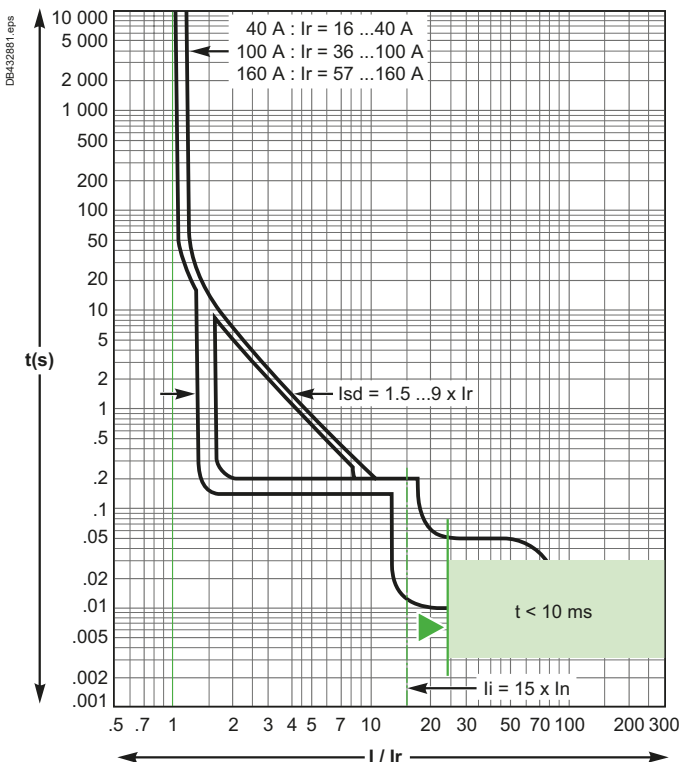

MicroLogic 2.2 G - 250 A

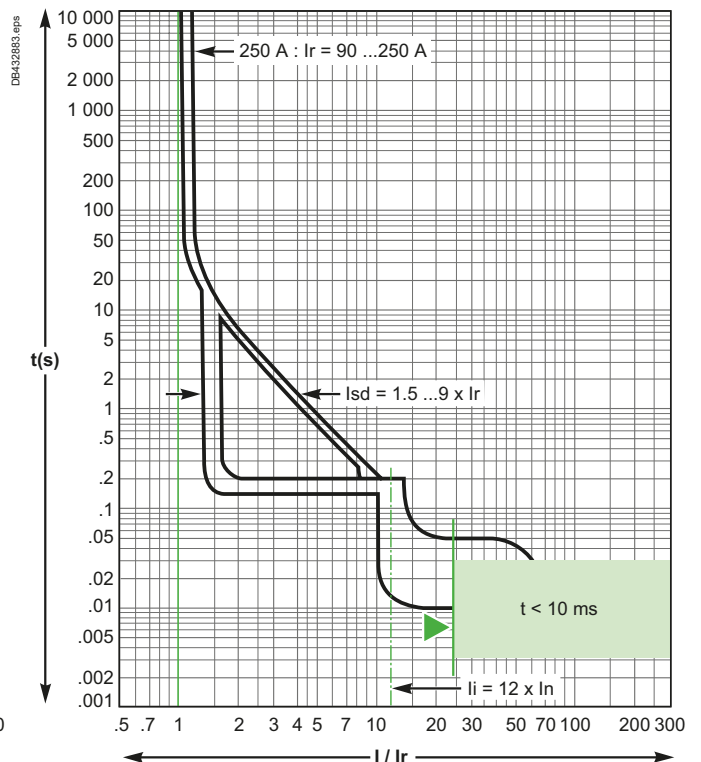

Reflex tripping.



Additional Characteristics

ComPacT NSX100 to 250

MicroLogic 5.2 and 6.2 E and 7.2 E Electronic Trip Units, Tripping Curves - Protection of Distribution Systems

MicroLogic 5.2 E, 6.2 E and 7.2 E - 40... 160 A

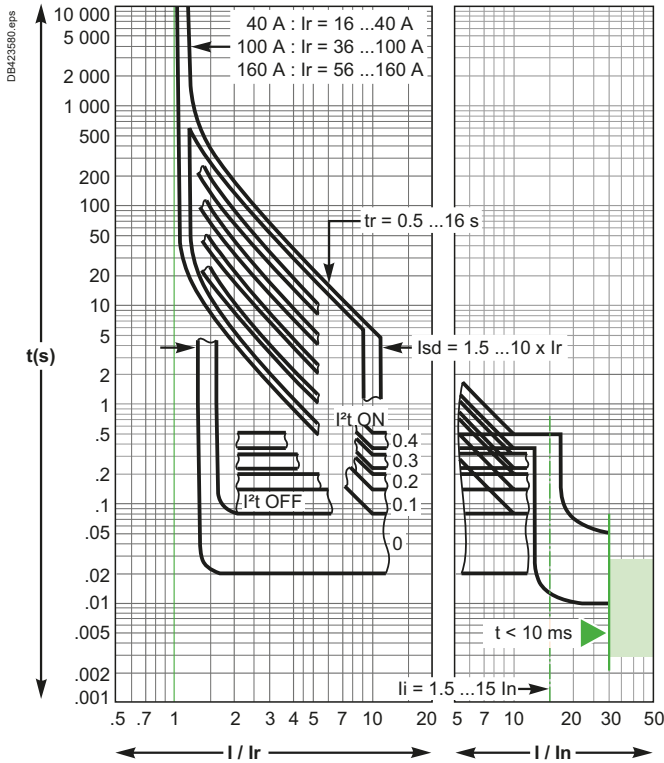

Reflex tripping.

MicroLogic 5.2 E, 6.2 E and 7.2 E - 250 A

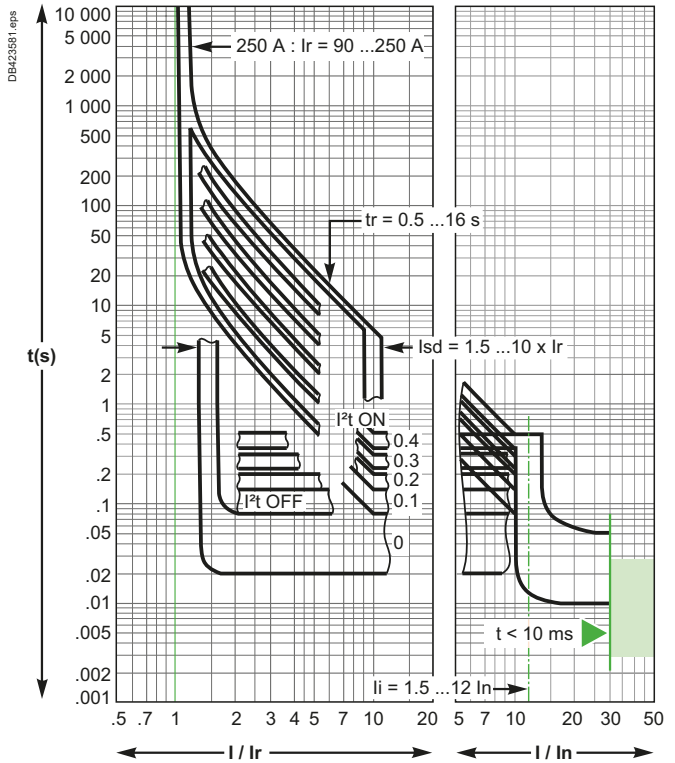

MicroLogic 6.2 E (Ground-Fault Protection)

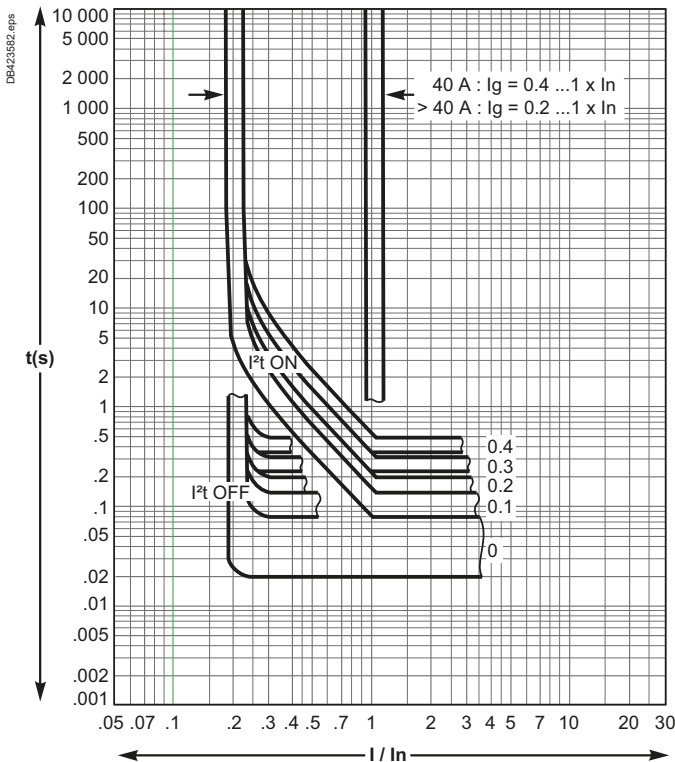

Reflex tripping.



ComPacT NSX100 to 250

MA Magnetic Trip Units, MicroLogic 2.2 M Electronic Trip Units, Tripping Curves - Motor Protection

MA2.5... MA100

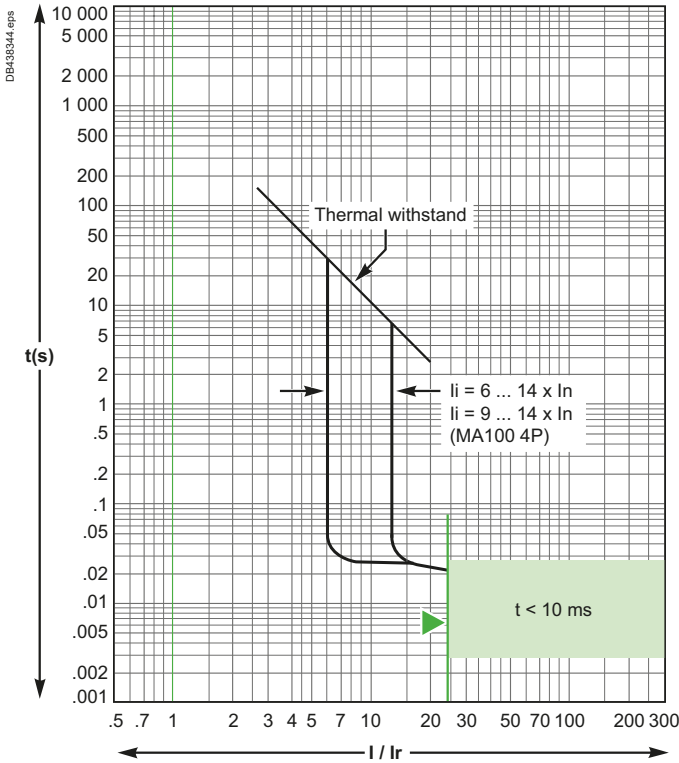

MA150 and MA220

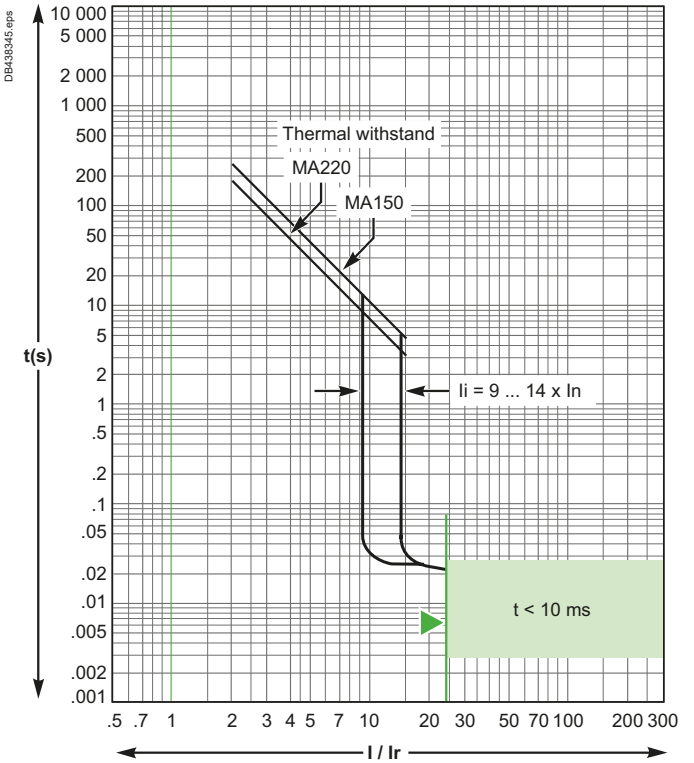

Reflex tripping.

MicroLogic 2.2 M - 25 A

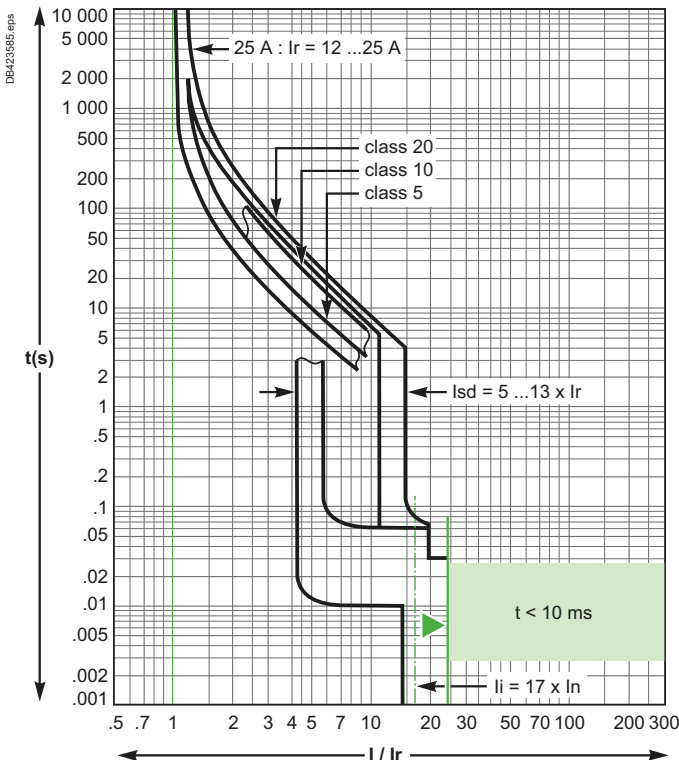

MicroLogic 2.2 M - 50... 220 A

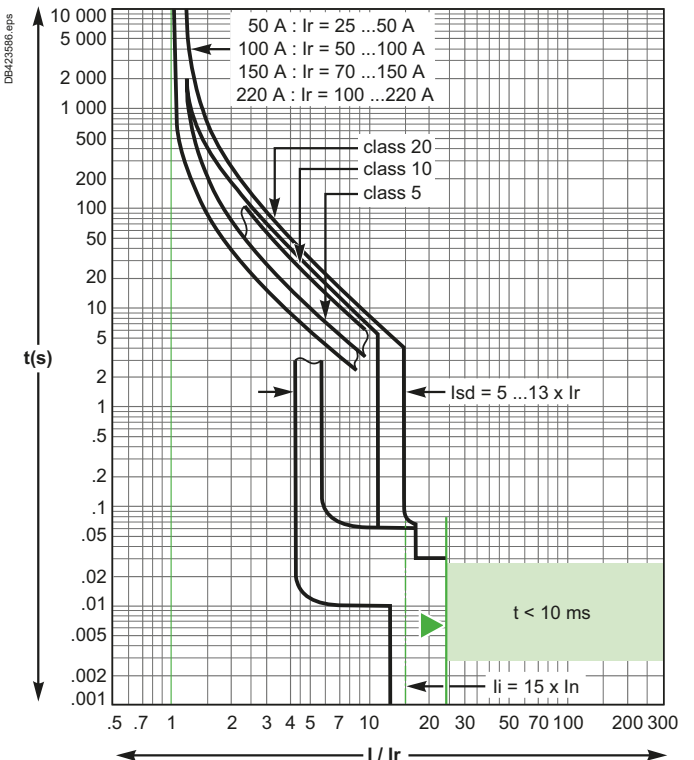

Reflex tripping.



Additional Characteristics

ComPacT NSX100 to 250

MicroLogic 6.2 E-M Electronic Trip Units, Tripping Curves Motor Protection

MicroLogic 6.2 E-M - 25 A

MicroLogic 6.2 E-M - 50... 220 A

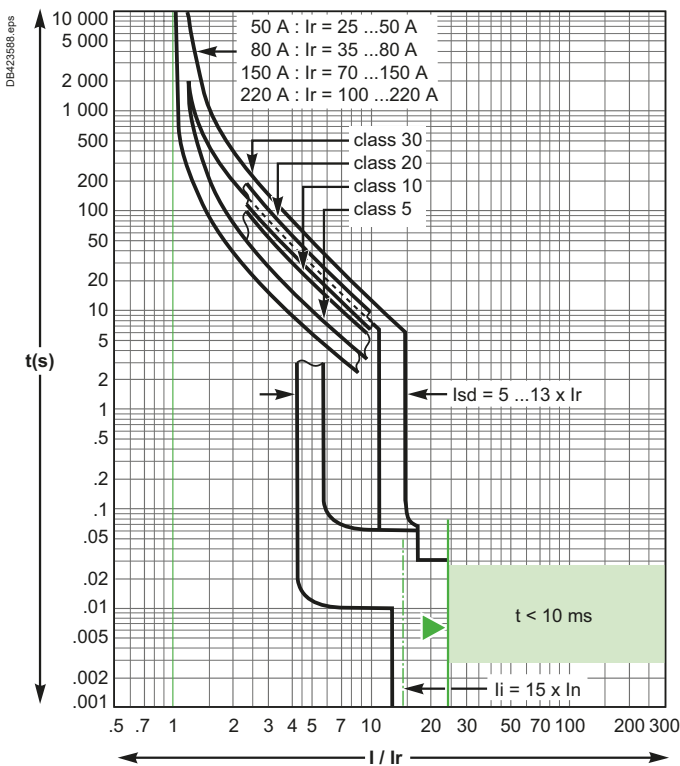
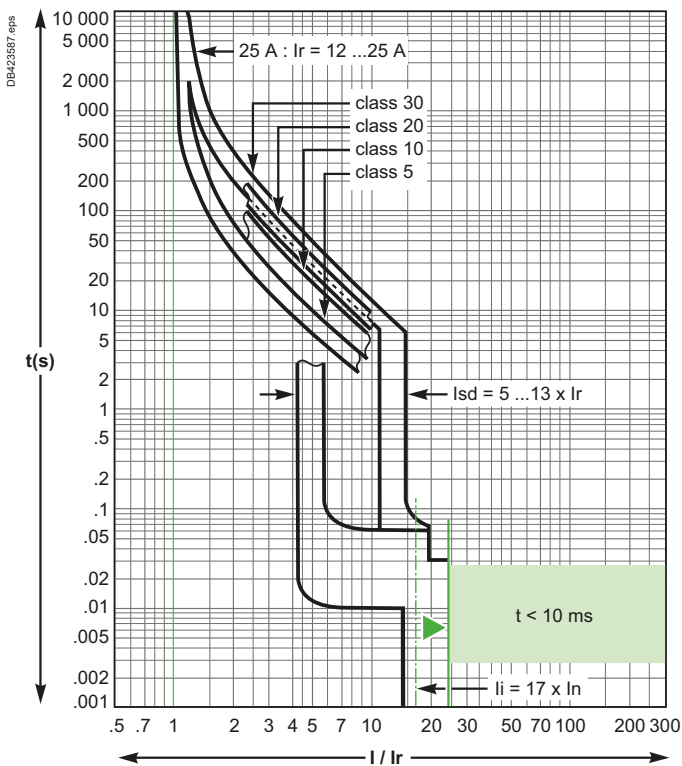

Reflex tripping.

MicroLogic 6.2 E-M (Ground-Fault Protection)

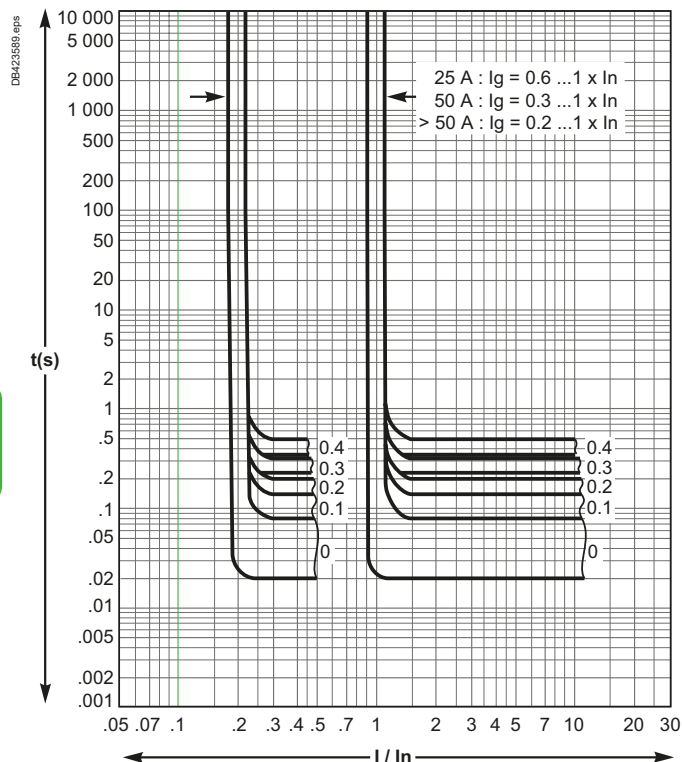

ComPacT NSX400 to 630

MicroLogic 2.3, 4.3, 5.3 and 6.3 E and 7.3 E Electronic Trip Units, Tripping Curves - Protection of Distribution Systems

MicroLogic 2.3, 4.3 - 250... 400 A

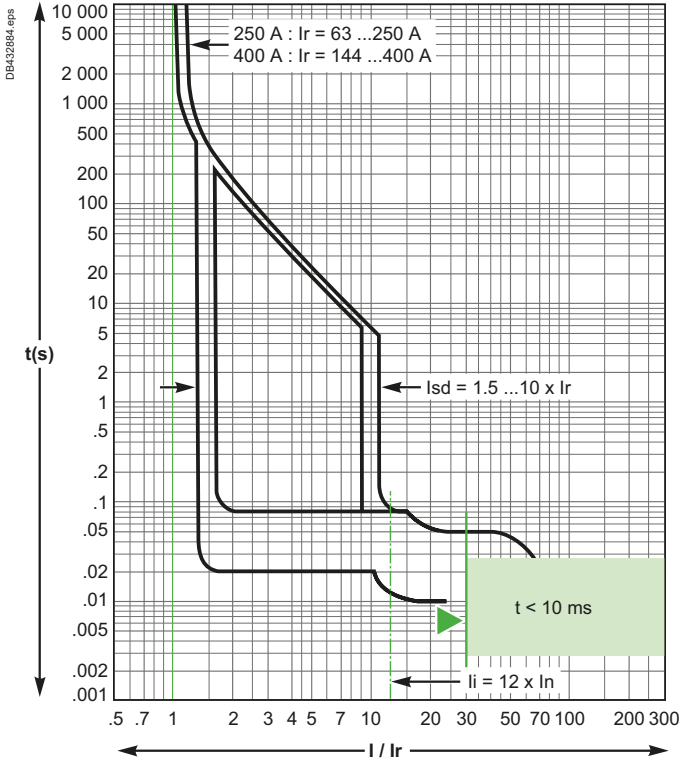

MicroLogic 2.3, 4.3 - 630 A

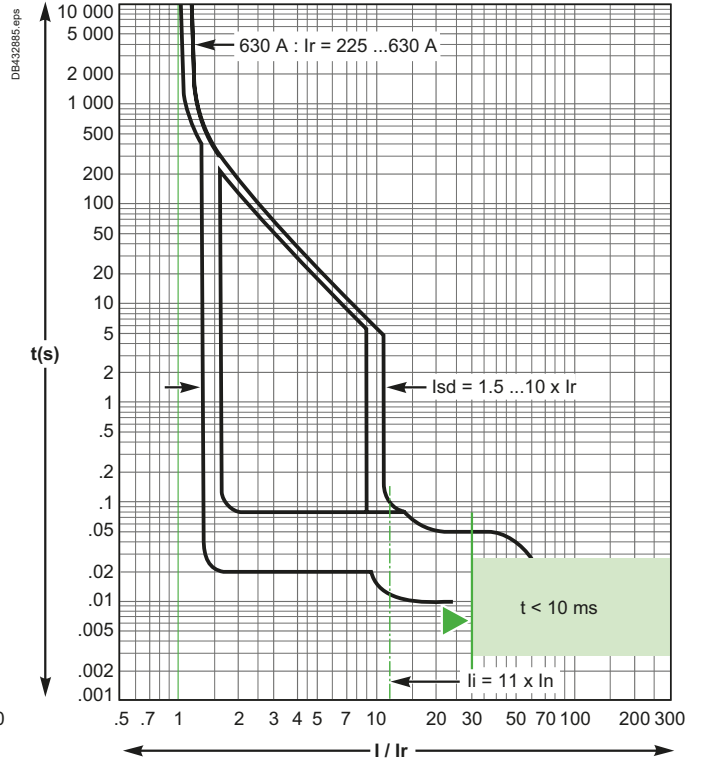

MicroLogic 5.3 and 6.3 E and 7.3 E - 400 A

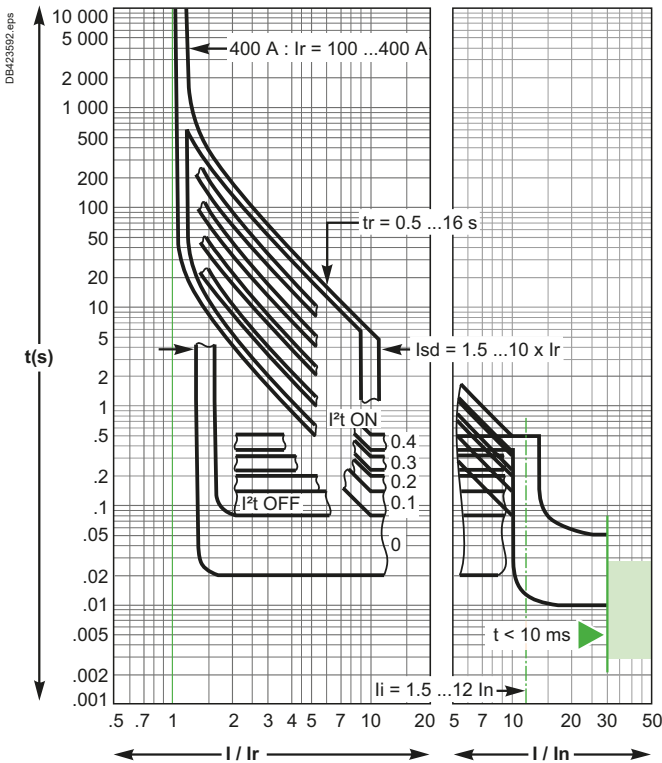

MicroLogic 5.3 and 6.3 E and 7.3 E (up to 570 A) - 630 A

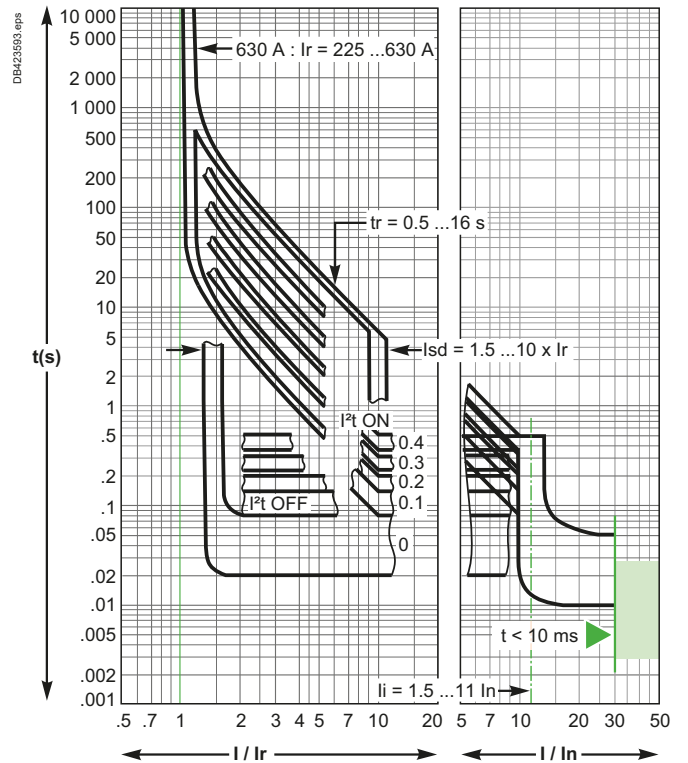

Additional Characteristics

ComPacT NSX400 to 630

MicroLogic 6.3 E and 7.3 E Electronic Trip Units, Tripping Curves - Protection of Distribution Systems

MicroLogic 6.3 E and 7.3 E (up to 570 A)
(Ground-Fault Protection)

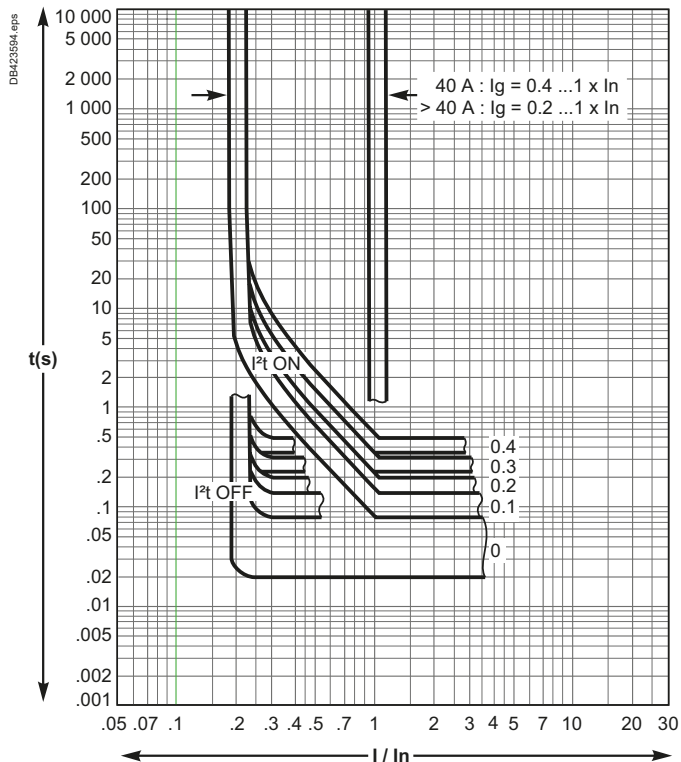

ComPacT NSX400 to 630

MicroLogic 1.3 M and 2.3 M Electronic Trip Units, Tripping Curves Motor Protection

MicroLogic 1.3 M - 320 A

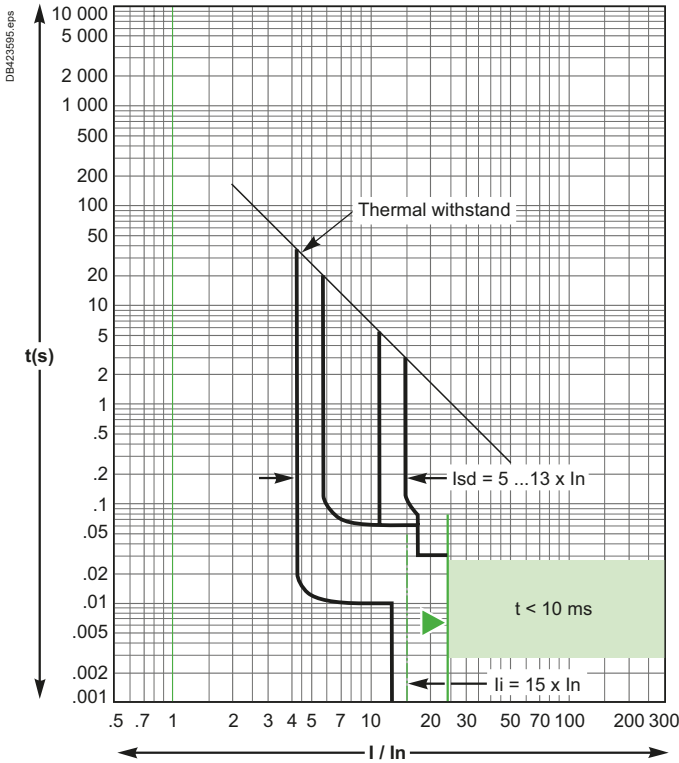

Reflex tripping.

MicroLogic 1.3 M - 500 A

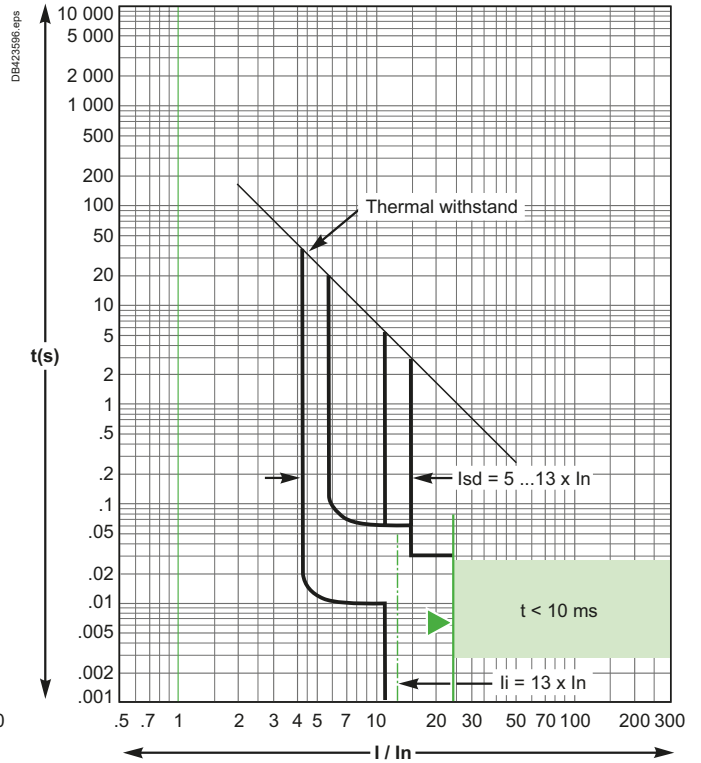

MicroLogic 2.3 M - 320 A

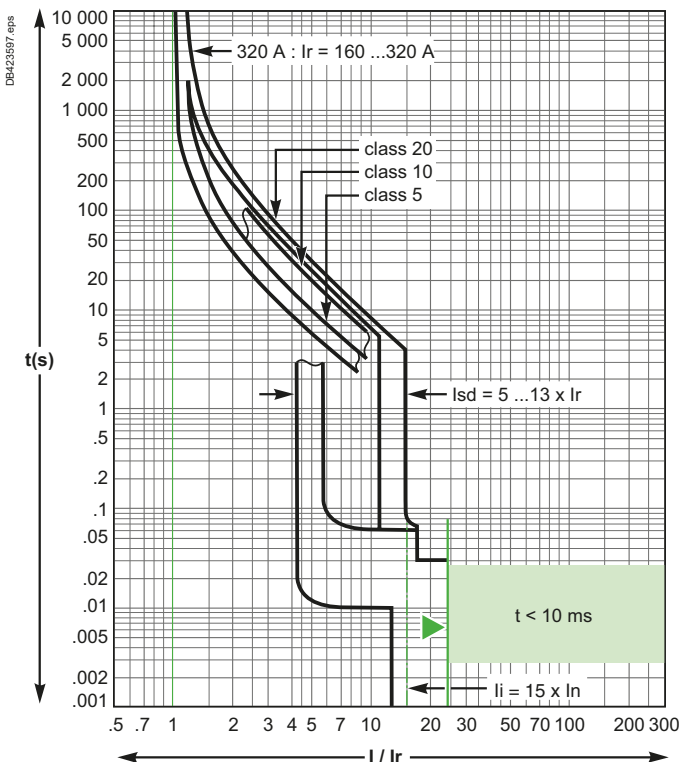

Reflex tripping.

MicroLogic 2.3 M - 500 A

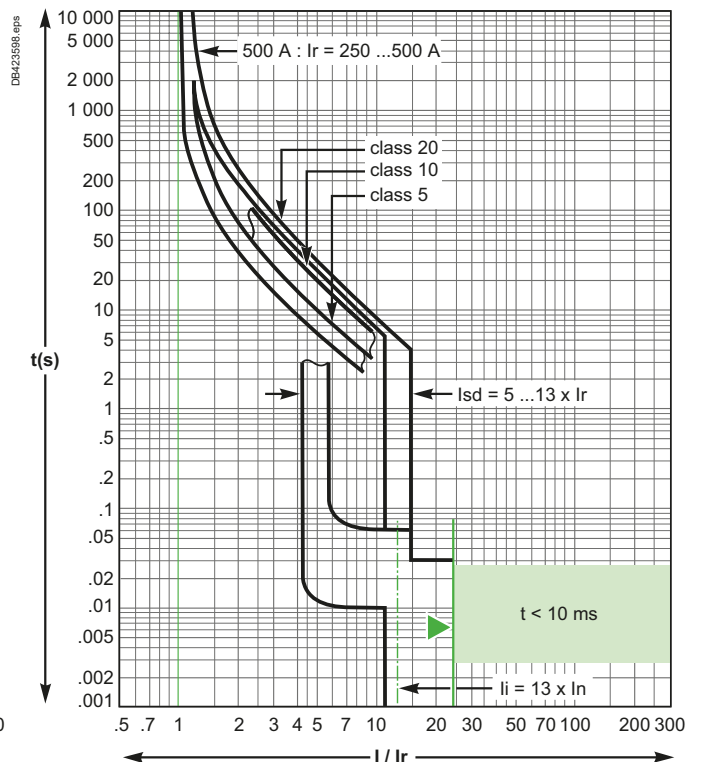

ComPacT NSX400 to 630

MicroLogic 6.3 E-M Electronic Trip Units, Tripping Curves Motor Protection

MicroLogic 6.3 E-M - 320 A

MicroLogic 6.3 E-M - 500 A

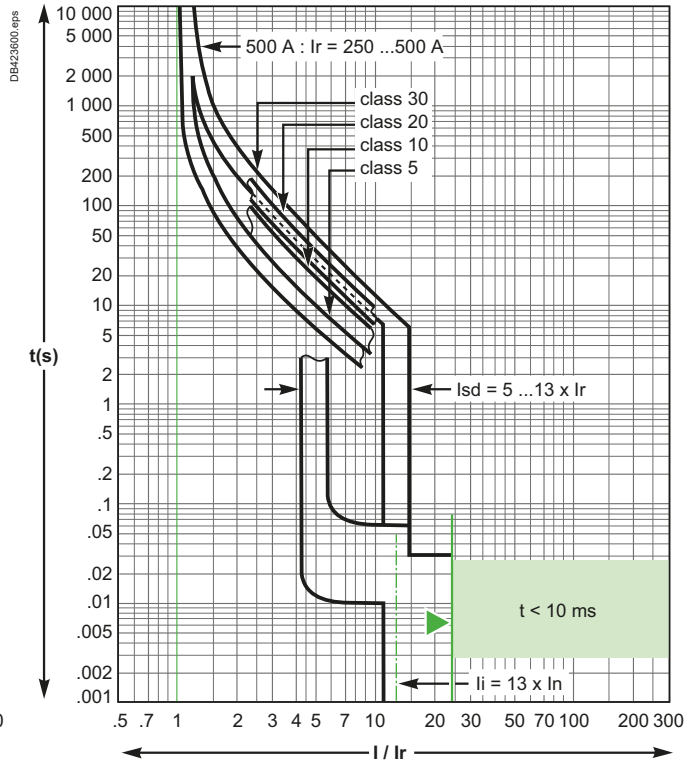
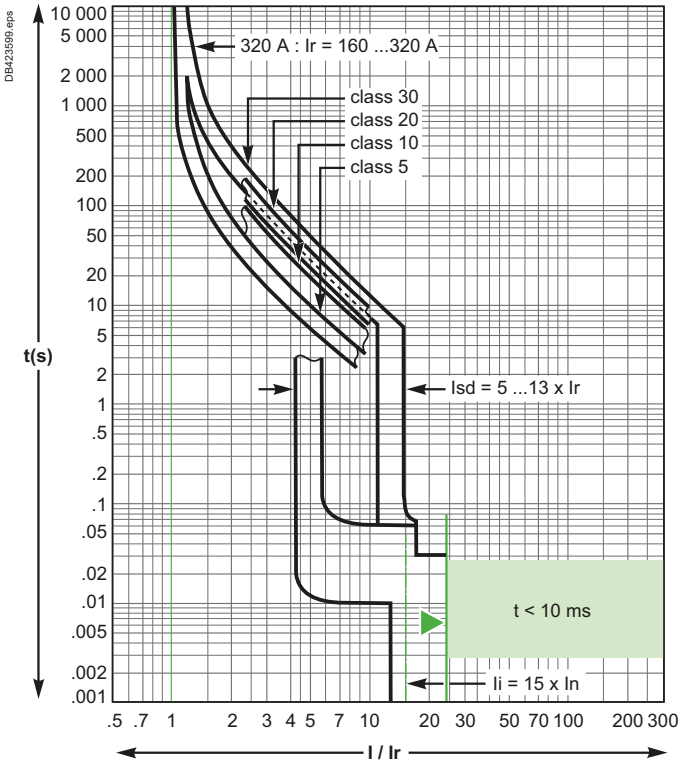

Reflex tripping.

MicroLogic 6.3 E-M (Ground Fault Protection)

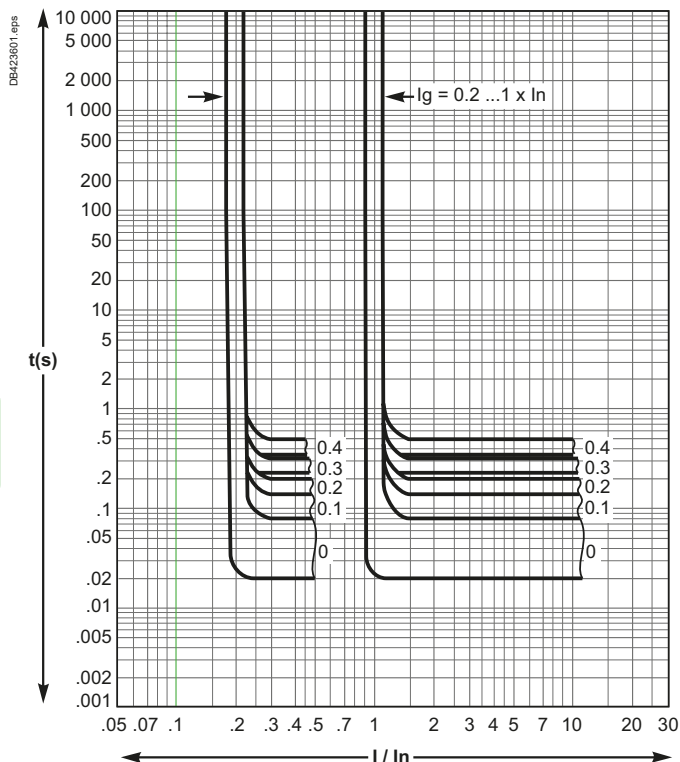

Tripping Curves ComPacT NSXm and NSX

Reflex tripping

ComPacT NSXm and NSX100 to 630 devices incorporate the exclusive reflex-tripping system. This system breaks very high fault currents. The device is mechanically tripped via a "piston" actuated directly by the pressure produced in the breaking units by the short-circuit. For high short-circuits, this system provides a faster break, thereby ensuring selectivity. Reflex-tripping curves are exclusively a function of the circuit-breaker rating.

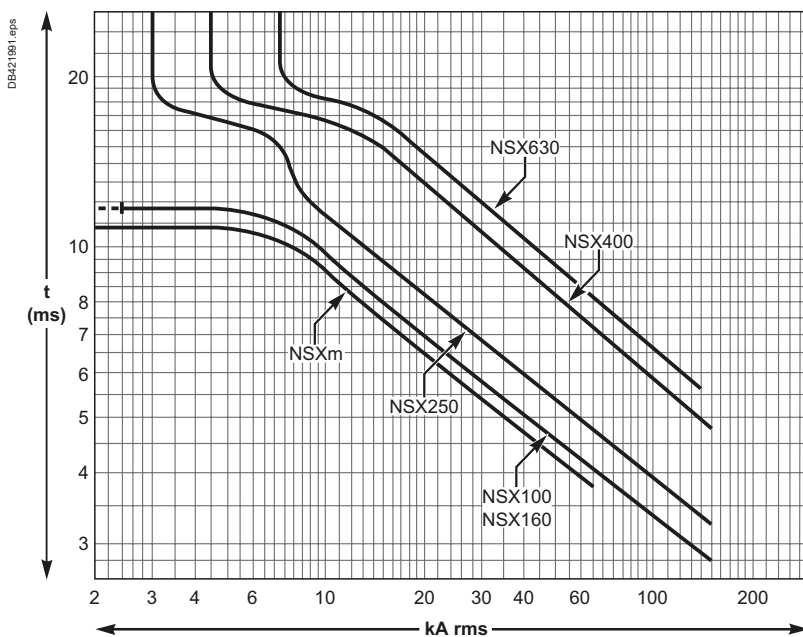

Current and Energy Limiting Curves

The limiting capacity of a circuit breaker is its aptitude to let through a current, during a short-circuit, that is less than the prospective short-circuit current.

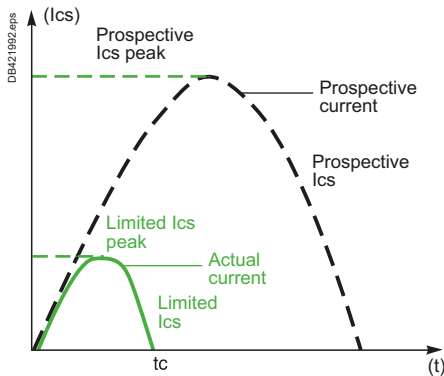

The exceptional limiting capacity of the ComPacT range is due to the rotating double-break technique (very rapid natural repulsion of contacts and the appearance of two arc voltages in-series with a very steep wave front).

Ics = 100 % Icu

The exceptional limiting capacity of the ComPacT NSX and NSXm ranges greatly reduces the forces created by fault currents in devices. The result is a major increase in breaking performance. In particular, the service breaking capacity Ics is equal to 100 % of Icu. The Ics value, defined by IEC standard 60947-2, is guaranteed by tests comprising the following steps:

- Break three times consecutively a fault current equal to 100 % of Icu
- Check that the device continues to function normally, that is:
 - It conducts the rated current without abnormal temperature rise
 - Protection functions perform within the limits specified by the standard
 - Suitability for isolation is not impaired.

Longer service life of electrical installations

Current-limiting circuit breakers greatly reduce the negative effects of short-circuits on installations.

Thermal effects

Less temperature rise in conductors, therefore longer service life for cables.

Mechanical effects

Reduced electrodynamic forces, therefore less risk of electrical contacts or busbars being deformed or broken.

Electromagnetic effects

Fewer disturbances for measuring devices located near electrical circuits.

Economy by means of cascading

Cascading is a technique directly derived from current limiting. Circuit breakers with breaking capacities less than the prospective short-circuit current may be installed downstream of a limiting circuit breaker. The breaking capacity is reinforced by the limiting capacity of the upstream device. It follows that substantial savings can be made on downstream equipment and enclosures.

Current and energy limiting curves

The limiting capacity of a circuit breaker is expressed by two curves which are a function of the prospective short-circuit current (the current which would flow if no protection devices were installed):

- The actual peak current (limited current)
- Thermal stress (A²s), i.e. the energy dissipated by the short-circuit in a conductor with a resistance of 1 Ω.

Example

What is the real value of a 70 kA rms prospective short-circuit (i.e. 100 kA peak) limited by an NSXm160H upstream ?

The answer is 20 kA peak.

Maximum permissible cable stresses

The table below indicates the maximum permissible thermal stresses for cables depending on their insulation, conductor (Cu or Al) and their cross-sectional area (CSA). CSA values are given in mm² and thermal stresses in A²s.

CSA		1.5 mm ²	2.5 mm ²	4 mm ²	6 mm ²	10 mm ²
PVC	Cu	2.97x10 ⁴	8.26x10 ⁴	2.12x10 ⁵	4.76x10 ⁵	1.32x10 ⁶
	Al					5.41x10 ⁵
PRC	Cu	4.10x10 ⁴	1.39x10 ⁵	2.92x10 ⁵	6.56x10 ⁵	1.82x10 ⁶
	Al					7.52x10 ⁵
PVC	Cu	3.4x10 ⁶	8.26x10 ⁶	1.62x10 ⁷	3.31x10 ⁷	
	Al	1.39x10 ⁶	3.38x10 ⁶	6.64x10 ⁶	1.35x10 ⁷	
PRC	Cu	4.69x10 ⁶	1.39x10 ⁷	2.23x10 ⁷	4.56x10 ⁷	
	Al	1.93x10 ⁶	4.70x10 ⁶	9.23x10 ⁶	1.88x10 ⁷	

Example

Is a Cu/PVC cable with a CSA of 10 mm² adequately protected by an NSX160F?

The table above indicates that the permissible stress is 1.32x10⁶ A²s.

All short-circuit currents at the point where an NSX160F (Icu = 35 kA) is installed are limited with a thermal stress less than 6x10⁵ A²s.

Cable protection is therefore ensured up to the limit of the breaking capacity of the circuit breaker.

Current and Energy Limiting Curves ComPacT NSXm

Current-limiting curves

Voltage 400/440 V AC

Limited short-circuit current (kA peak)

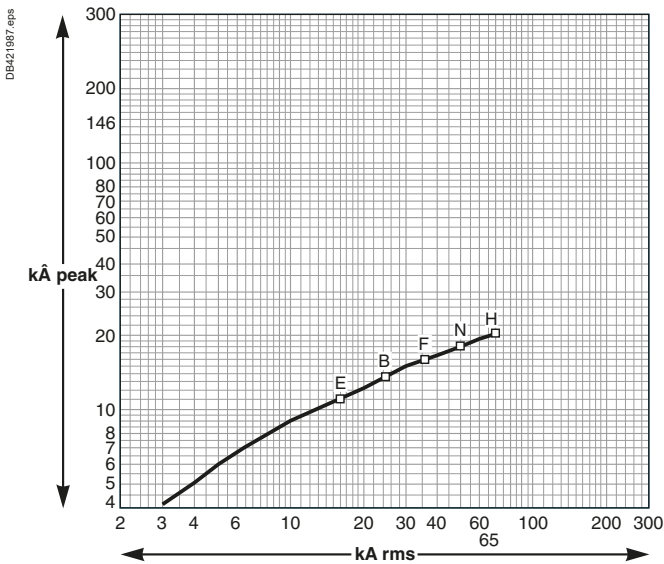

Voltage 660/690 V AC

Limited short-circuit current (kA peak)

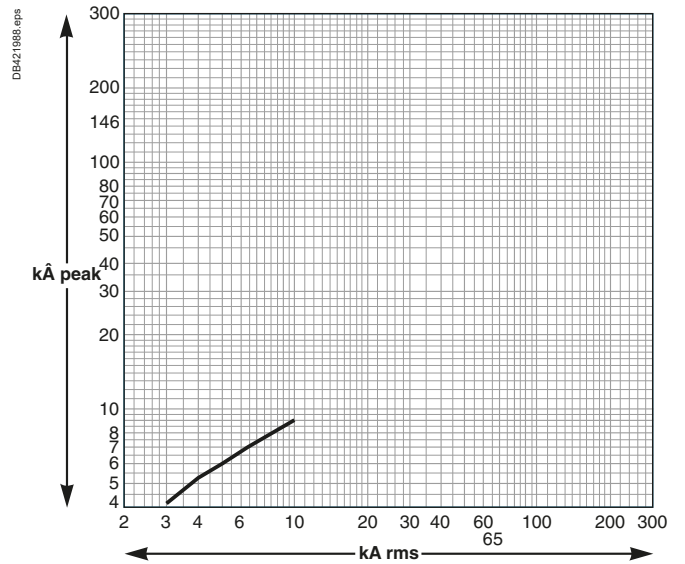

Energy-limiting curves

Voltage 400/440 V AC

Limited energy

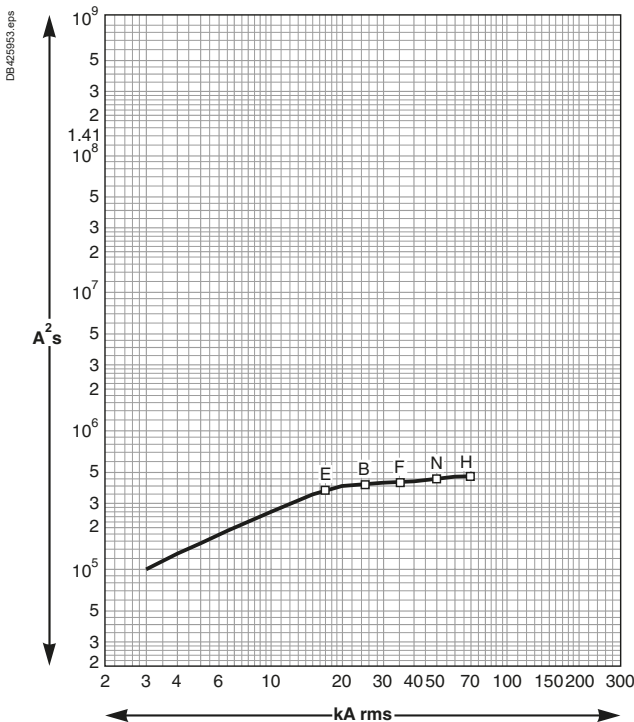

Voltage 660/690 V AC

Limited energy

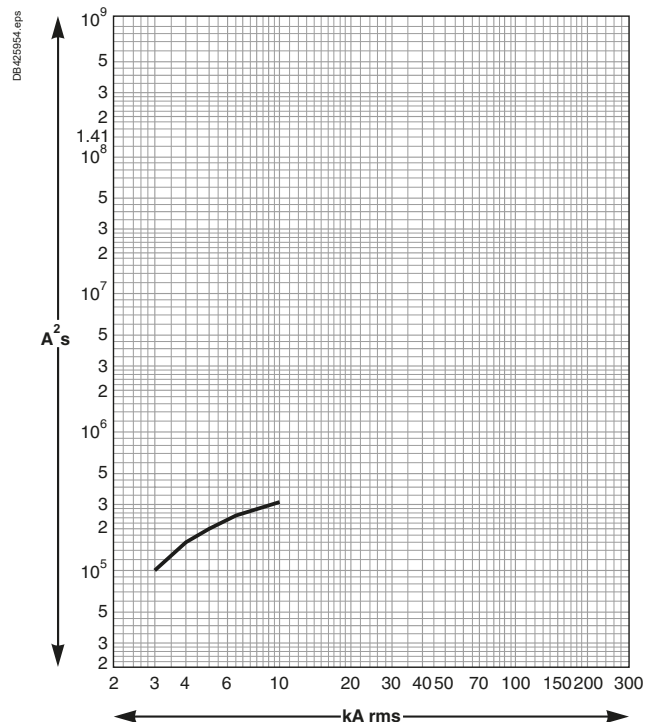

Current and Energy Limiting Curves

ComPacT NSX

Current-limiting curves

Voltage 400/440 V AC

Limited short-circuit current (kA peak)

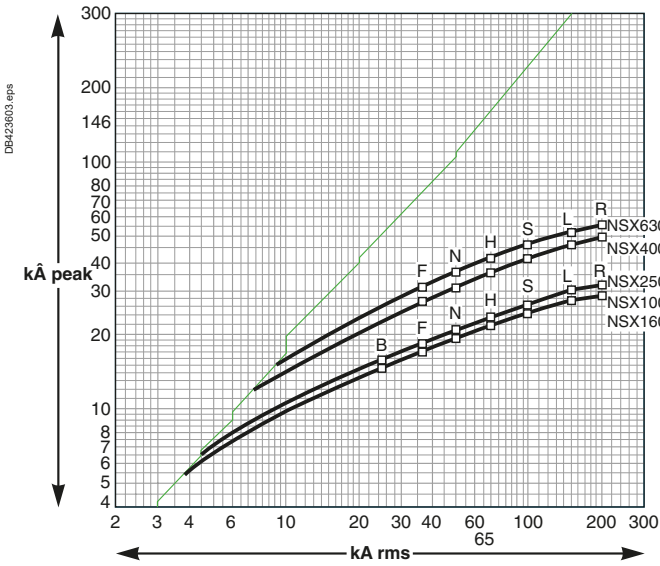

Voltage 660/690 V AC

Limited short-circuit current (kA peak)

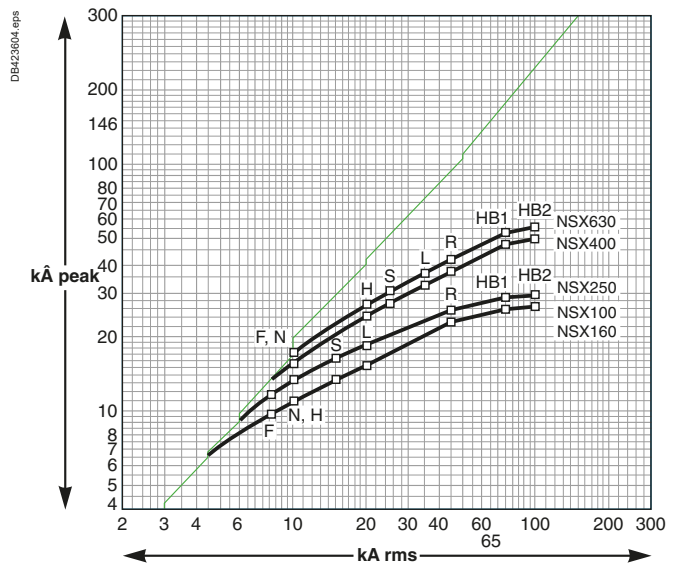

Energy-limiting curves

Voltage 400/440 V AC

Limited energy

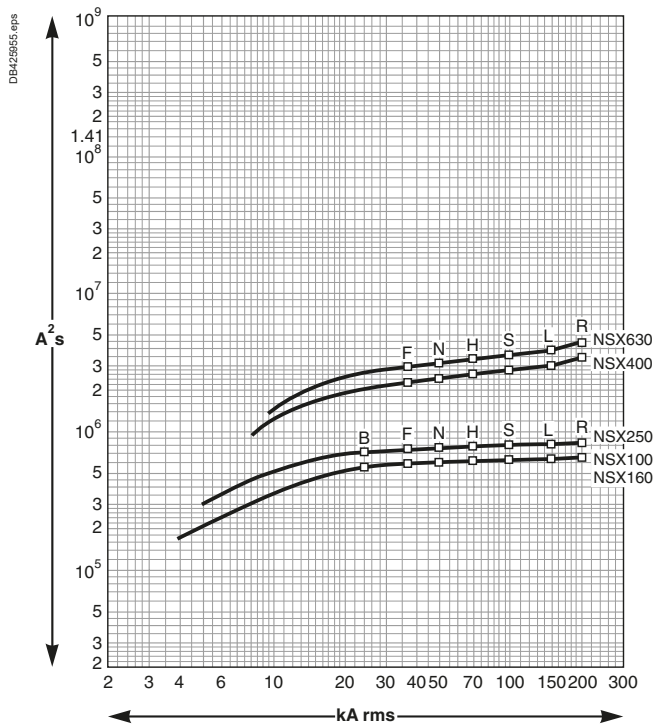

Voltage 660/690 V AC

Limited energy

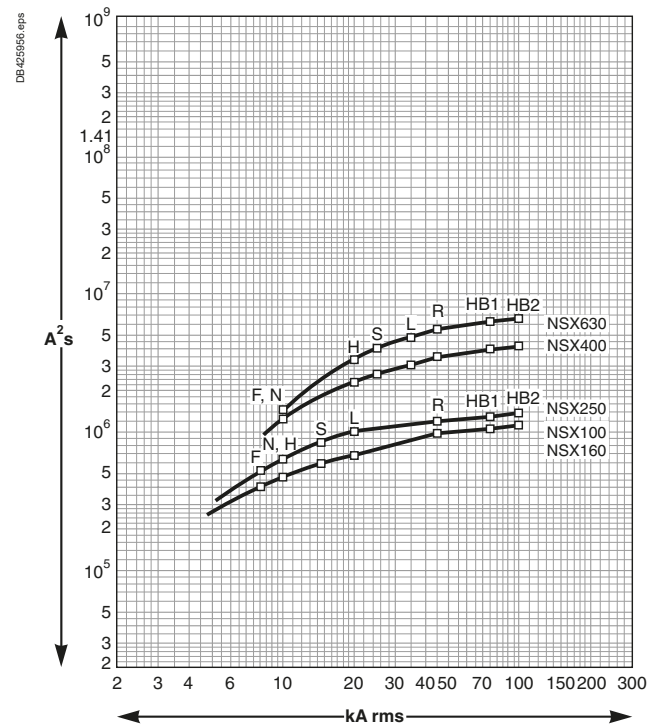

Life Is On

Schneider
Electric

Schneider Electric Industries SAS

35, rue Joseph Monier
CS 30323
92506 Rueil Malmaison Cedex
France

RCS Nanterre 954 503 439
Capital social 928 298 512 €
www.se.com

01-2021

© 2021 - Schneider Electric. All Rights Reserved.
All trademarks are owned by Schneider Electric Industries SAS or its affiliated companies.
Document reference: LVPED221001EN