

PacT Series

ComPacT NSX & NSXm

Substitution and Technical Guide

Catalog 2021

Molded-Case Circuit Breakers
And Switch-Disconnectors
From 16 To 630 A - Up To 690 V





Green Premium™



More than 75% of our product sales offer superior transparency on the material content, regulatory information and environmental impact of our products:

- RoHS compliance
- REACH substance information
- Industry leading # of PEP's*
- Circularity instructions



Discover what we mean by green
Check your products!

The Green Premium program stands for our commitment to deliver customer valued sustainable performance. It has been upgraded with recognized environmental claims and extended to cover all offers including Products, Services and Solutions.

CO₂ and P&L impact through... Resource Performance

Green Premium brings improved resource efficiency throughout an asset's lifecycle. This includes efficient use of energy and natural resources, along with the minimization of CO₂ emissions.

Cost of ownership optimization through... Circular Performance

We're helping our customers optimize the total cost of ownership of their assets. To do this, we provide IoT-enabled solutions, as well as upgrade, repair, retrofit, and remanufacture services.

Peace of mind through... Well-being Performance

Green Premium products are RoHS and REACH compliant. We're going beyond regulatory compliance with step-by-step substitution of certain materials and substances from our products.

Improved sales through... Differentiation

Green Premium delivers strong value propositions through third-party labels and services. By collaborating with third-party organizations we can support our customers in meeting their sustainability goals such as green building certifications.

*PEP: Product Environmental Profile (i.e. Environmental Product Declaration)

ComPacT NSX and NSXm, even more innovative and efficient

ComPacT circuit breakers feature Schneider Electric's exclusive Roto-Active Breaking System; it reduces the effects of short circuits of your installation.

Today, the ComPacT range is optimized with a high level of breaking capacities, outstanding selectivity and cascading. It offers more advanced functions and ergonomic designs for easy installation and operations.

Eleven Performance Levels

K | HB2 | HB1 | R | L | S | H | N | F | B | E

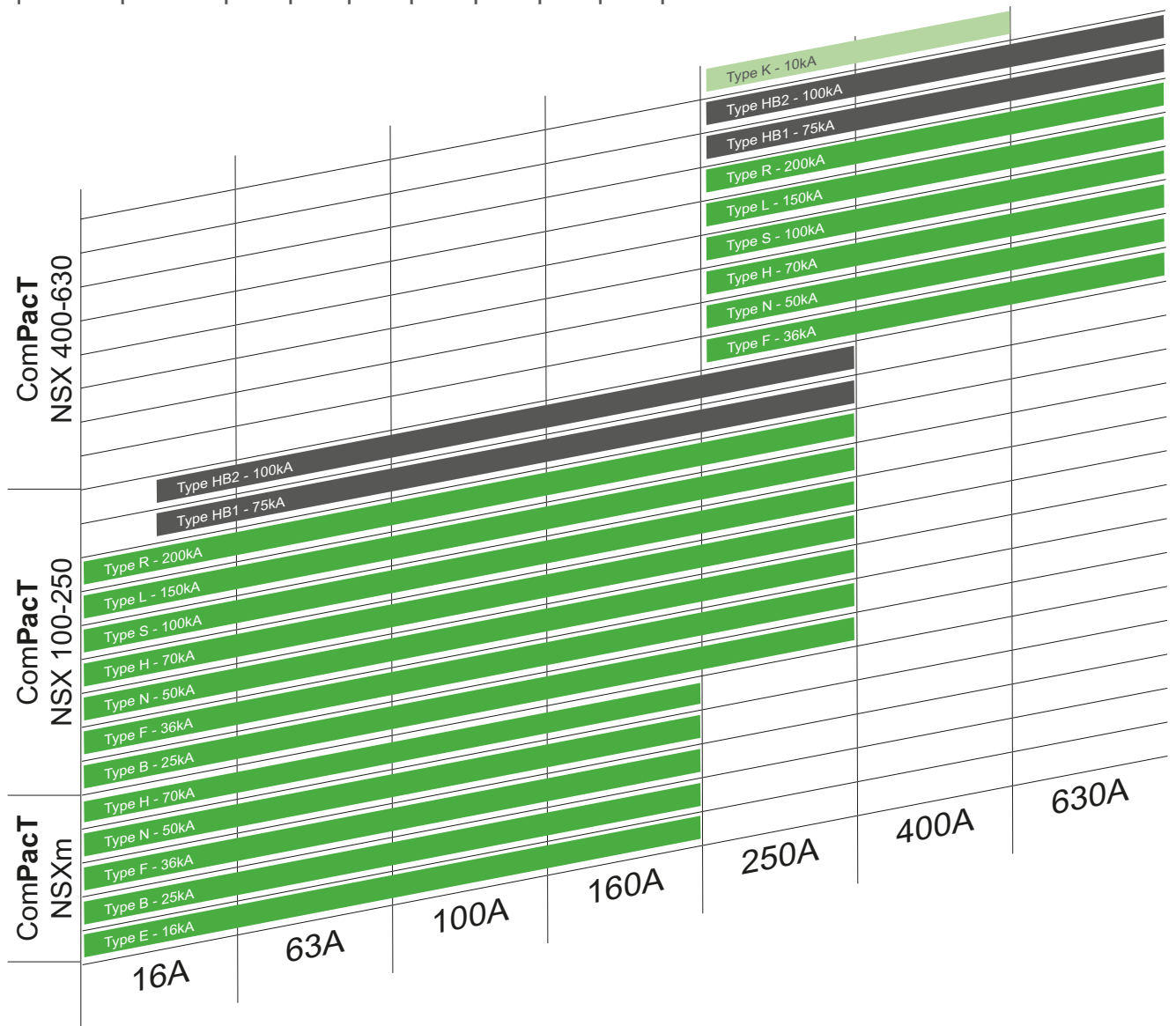

l_{cu} = (kA rms) at 1000V AC
 l_{cu} = (kA rms) at 690V AC
 l_{cu} = (kA rms) at 415V AC

Schneider Electric is proud to introduce the new generation of ComPacT MCCBs. These breakers talk to you, wherever you are, in all transparency. New design complements new wireless connectivity capabilities with our latest wireless auxiliary contact.

New

ComPacT Design

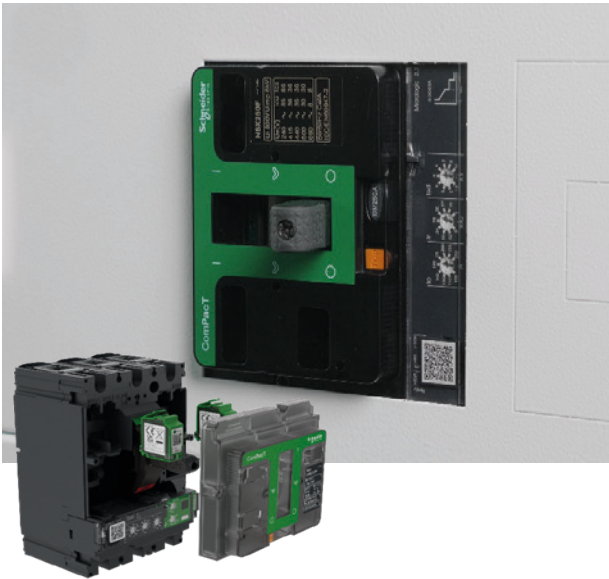

New signature design

- Schneider Electric green signature style for the entire ComPacT range
- Estimated 40% reduction of wiring time for panel builders
- Experience easier installation thanks to a new ergonomic front-plate design
- Gain the confidence that all auxiliaries are on the right spot, and simply double check that you have the right coil rating
- Ergonomic new toggle for easier breaker manual operation

New

Wireless Auxiliary Contact



Wireless breaker status

- Plug & play technology for clear connection status (0 or 1, no half-way wired)
- Placed in the same position as the wired version, its LED light will give you direct indication in case of a tripping
- If you are away, your ComPacT will send you an immediate notification via EcoStruxure Facility Expert for instance
- Wireless auxiliary accelerates overall wiring time: status communication is done very simply and commissioned wirelessly
- Communication architecture is fully EcoStruxure Power validated, with any application

Ready to meet the new face of ComPacT?



In 2021 you will meet the new generation of ComPacT™ circuit breakers with semi-transparent faceplate, screwless auxiliaries and remote monitoring features.

Learn about the benefits of the ComPacT range here:
se.com/compact-nsx

While we are launching a new generation of ComPacT breakers, we are building upon the very latest innovations that made the success of the range in the first place. The following innovations were launched recently and are still very much applicable to the new generation of ComPacT breakers.

ComPacT NSXm



Smallest size in the range

- ComPacT NSXm is the smallest frame size in the range, incorporating new features and innovations
- Gain up to 40% in space when using with integrated earth leakage protection
- Reduce up to 40% mounting and cabling time with EverLink™ connectors, built-in DIN rail and spring-type auxiliaries
- Select, configure and commission with ease, thanks to Schneider Electric online tools: EcoStruxure Customer Lifecycle Software, such as EcoStruxure Power Design – Ecodial

MicroLogic Vigi



Integrated earth leakage protection

- Easy to integrate into a row that does not have earth leakage protection
- Simple to use, reliable, and now comes in the same frame size, and for the same panel support
- Gain up to 40% in space when using with integrated earth leakage protection into the MicroLogic Vigi trip units
- Standard protection of distribution cables
- Part of the EcoStruxure Power architecture, with digital communication capability and data management (settings, measurement, pre-alarms, trip & test history)

Innovation that protects:



In 2021 you will meet the new generation of ComPacT™ circuit breakers with semi-transparent faceplate, screwless auxiliaries and remote monitoring features.

Learn about the benefits of the ComPacT NSX range here:
se.com/compact-nsx

Optimized size and innovations tailored to your needs

Roto-active™ breaking technology

While the ComPacT NSXm is the smallest breaker in the ComPacT range, it nonetheless features all the innovations from previous generations, and notably includes roto-active breaking technology. Schneider Electric was the first to introduce this technology - an innovation in which the effective fault current limitation benefits the entire installation, particularly its cables.

Reduce the effects of short circuits to extend your installation life:

- Increase life duration of all items downstream of the electrical network
- Provide both outstanding selectivity and cascading

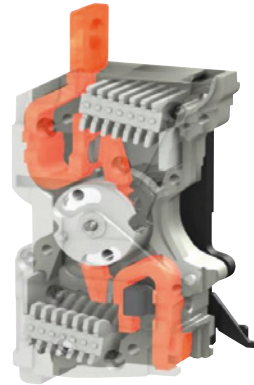

EverLink™ connectors – for enduring protection



ComPacT NSXm

The ComPacT NSXm features EverLink, an innovative cable connection method with patented creep-compensating technology that is built directly into the terminal. EverLink gives you:

- Confidence that your electrical connections maintain consistent pressure on the cable over time
- A space-saving solution as bare cable connections are as reliable as compression lug cable connections
- IP40 protection available thanks to transparent long terminal shield

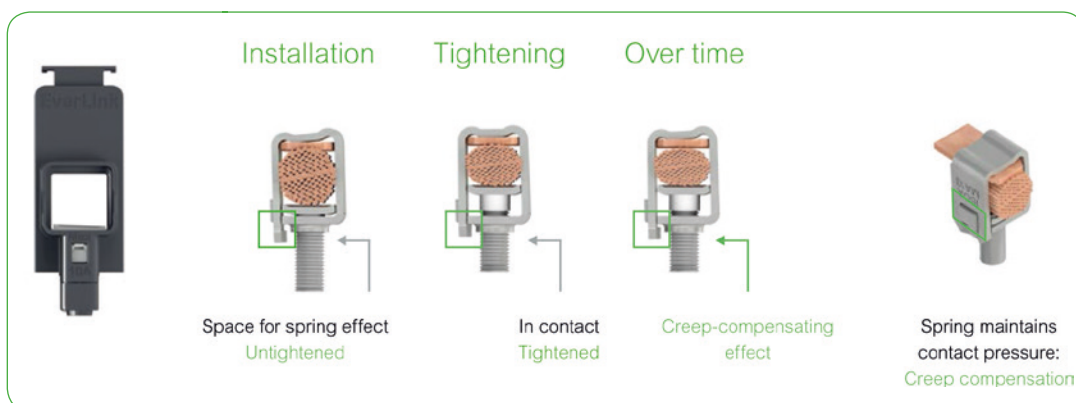

Contribute to a better world. Enhance sustainability with ComPacT range

Achieve Green Building certification with Green Premium ecolabel

In compliance with ISO 14025 PEP ecopassport program, we publish a comprehensive Life Cycle Analysis of our product, providing the environmental data you need to achieve Green Building certifications.

For example, ComPacT NSX & NSXm contribute to 3 LEED™ points in the Building Product Disclosure and Optimization section:

- Environmental Product Declaration
- Material Ingredients



ComPacT NSX range is now enriched with the new ComPacT NSXm, designed according to the EcoDesign Way™ by Schneider. It now features new space saving frame size for reduced resource consumption, and more.



New Packaging

- The ComPacT range comes in plastic-less packaging: not only to reduce our carbon footprint, but it also means less waste in the workshop
- Simplified instruction sheets included in all packaging
- 100% recycled carton
- Scan QR codes for access to digital documentation
- This product is REACH and RoHS compliant



Simpler names for our offers

We are making it easier for you to navigate across the wide range of our world-class digital offerings and select with confidence the offers that are right for you and your needs.

EcoStruxure Architecture

To enable brand consistency, relevance and impact, we are reinforcing our EcoStruxure™ architecture and digital customer lifecycle tools to ensure a seamless experience from the CAPEX to OPEX phases of each project, bridging our entire ecosystem of partners, services providers and end users.

EcoStruxure is our IoT-enabled open and interoperable system architecture and platform. EcoStruxure delivers enhanced values around safety, reliability, efficiency, sustainability and connectivity for our customers. EcoStruxure leverages advancements in IoT, mobility, sensing, cloud, analytics, and cybersecurity technologies to deliver Innovation At Every Level from Connected Products; Edge Control; and Apps, Analytics & Services: our IoT technology Levels.

Old names	New names
Ecodial	EcoStruxure Power Design
Ecoreal	EcoStruxure Power Build
Ecoreach	EcoStruxure Power Commission
Masterpact MTZ mobile App	EcoStruxure Power Device App

PacT Series

Future-proof your installation with Schneider Electric's low and medium voltage **PacT** Series. Built on legendary Schneider Electric innovation, the **PacT** Series comprises world-class circuit breakers, switches, residual current devices and fuses, for all standard and specific applications. Experience robust performance with this comprehensive range of EcoStruxure- ready switchgear, for all applications from 16 to 6300 A.

Old names	New names
Compact	Com PacT
Masterpact	Master PacT
Micrologic	Micro Logic
Transferpact	Transfer PacT
Fupact	Fu PacT

This guide is intended to:

- > Provide the information you need to replace a device from the Com**Pact** NSX and NSXm range by a device from the Com**Pact** new generation range.
- > Help you understand the meaningful commercial reference coding rules.
- > Help you select a Com**Pact** NSX or NSXm device by referring to the previous range.
- > Help you select the accessories compatible with the **ComPact** new generation range.

For more information, see:

- > Com**Pact** NSX and NSXm Catalog 2021 LVPED221001EN
- > Com**Pact** NSX and NSXm User Guides



General contents

Performance Levels and Trip Units

ComPacT NSXm.....	2
ComPacT NSX100/160/250.....	3
ComPacT NSX400/630	5

Breaker and trip Unit Selection

Substitution for ComPacT NSX100/160/250.....	7
Substitution for ComPacT NSX400/630	9

Electrical Auxiliaries

Auxiliary Contacts and Voltage Releases.....	10
--	----

Substitution for Accessories

Substitution for Accessories ComPacT NSX100/160/250.....	11
Substitution for Accessories ComPacT NSX400/630.....	13

Substitution Table

Meaningful CR Coding Rules.....	15
Compatibility of Components of Existing and New ComPacT NSXm.....	16
Compatibility of Components of Existing and New ComPacT NSX100/160/250.....	23
Compatibility of Components of Existing and New ComPacT NSX400/630	38

ComPacT NSXm

> One identical frame size > 5 performance levels
E, B, F, N, H (at 415 V)



ComPacT NSXm



ComPacT NSXm

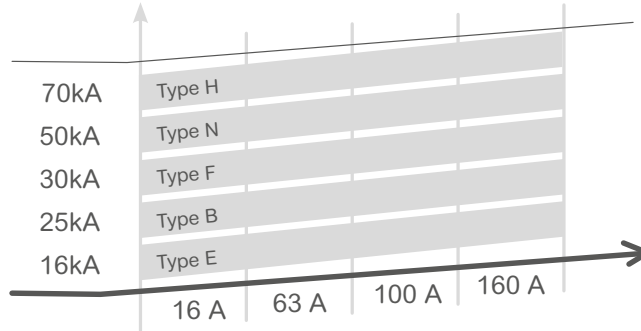

> Trip units for ComPacT NSXm

.....
Thermal-magnetic TM



TM-D
(Distribution)

In: 16 to 160 A
Ii: fixed magnetic pick-up
Ir: adjustable thermal pick-up from 0.7 to 1 x In

Micrologic 4 electronic



MicroLogic 4.1
(Distribution and earth leakage protection)

In: 25 to 160 A
Protection: LSIR
Indication:

- Overload alarming (via LEDs and via SDx module)
- Overload tripping (via the SDx module)
- Earth leakage alarming (via the SDx module)
- Earth leakage tripping (via front face screen and the SDx module).

Performance Levels and Trip Units ComPacT NSX100/160/250

> One identical frame size > 7 performance levels B, F, N, H, S, L (at 415 V) and 2 high performance levels R, HB1 and HB2 (at 690 V)



ComPacT
NSX100/160/250



ComPacT
NSX100/160/250

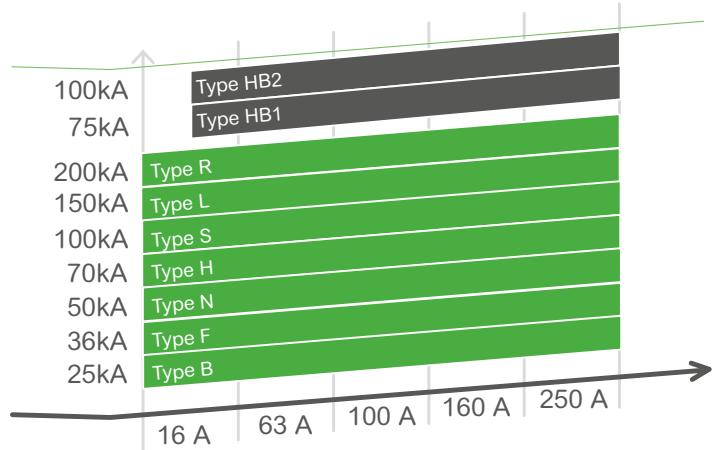

> Trip units for ComPacT NSX100/160/250

Magnetic MA and Thermal-magnetic TM

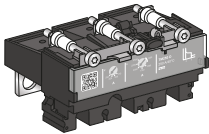

MA

In: 2.5 to 220 A
Ii: adjustable magnetic pick-up

TM-D
(Distribution)

In: 16 to 250 A
Ii: fixed magnetic pick-up
Ir: adjustable thermal pick-up from 0.7 to 1 x In

TM-G
(Generator)

In: 16 to 63 A
Ii: low pick-up
Ir: adjustable thermal pick-up from 0.7 to 1 x In

Electronic MicroLogic 2

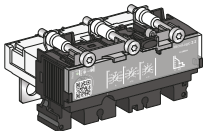

MicroLogic 2.2
(Distribution)

In: 40 to 250 A
Protection: LSI
Adjustable N protection on 4P devices: unprotected, N/2, N

MicroLogic 2.2-G
(Generator)

In: 40 to 250 A
Protection: LSI
Adjustable trip class: 5, 10, 20
Iumb: fixed phase unbalance pick-up (30%) with fixed time delay

MicroLogic 2.2 AB
(Public Distribution)

In: 100 to 240 A
Protection: LSI
Adjustable N protection on 4P devices: unprotected, N/2, N

Electronic MicroLogic 5/6

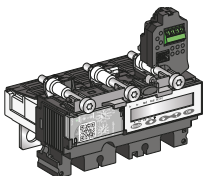

MicroLogic 5.2 E
(Distribution with measurements)

In: 40 to 250 A
Protection: LSI with fine adjustment and display
Adjustable N protection on 4P devices via keypad: unprotected, N/2, N, OSN

MicroLogic 6.2 E
(same as 5.2 E + ground fault prot.)

In: 40 to 250 A
Protection: LSIG with fine adjustment and display
G: Adjustable ground fault pick-up **Ig** and adjustable delay with I²t On/Off
Adjustable N protection on 4P devices via keypad: N/2, N, OSN

MicroLogic 6.2 E-M
(Motors + ground fault with E metering)

In: 25 to 220 A
Protection: LSIG with fine adjustment and display
Adjustable trip class: 5, 10, 20, 30
Adjustable phase unbalance **Iumb**, locked motor **Ijam**, underload **Iund** and long start **Ilong** pick-ups and time delays

MicroLogic 5.2 - AZ
(16 Hz 2/3 networks)

In: 100 to 250 A
Protection: LSI with fine adjustment and display
3P only. Special sampling frequency and measurements for 16Hz 2/3 networks

Electronic Micrologic 4/7

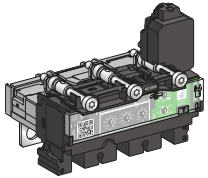

MicroLogic 4.2
 (Distribution)

In: 40 to 250 A
Protection: LSIR with fine adjustment
R: Adjustable leakage threshold ($I\Delta n$) and adjustable time delay threshold (Δt) by using the two dials on the green area of the trip

MicroLogic 4.2 AB
 (Distribution)

In: 40 to 250 A
Protection: LSIR with fine adjustment
R: Adjustable leakage threshold ($I\Delta n$) and adjustable time delay threshold (Δt) by using the two dials on the green area of the trip unit.
 ComPacT ELCB equipped with that "new" earth leakage trip unit Micrologic AB are installed as an incoming device for installation connected with the public LV distribution system. With respect to the utility requirement,

MicroLogic 4.2 AL
 (Distribution)

In: 40 to 250 A
Protection: Distribution protection including Earth Leakage Alarm (LSol + Earth Leakage).
R (alarm): Adjustable leakage threshold ($I\Delta n$) and adjustable time delay threshold (Δt) by using the two dials on the green area of the trip unit.

MicroLogic 7.2 E
 (Distribution with measurements)

In: 40 to 250 A
Protection: Distribution protection including Earth Leakage Protection (LSIR)
R: Adjustable leakage threshold ($I\Delta n$) and adjustable time delay threshold (Δt) by using the two dials on the green area of the trip
Energy management: the root cause of the fault (phase and interrupted current) is displayed additional to the compliance with the requirements of IEC 60364 8 1 dedicated to the optimization of energy efficiency.
 Micrologic 7.2 E provides a range of measurements with accuracies required for complex energy efficiency approaches.

MicroLogic 7.2 AL
 (Distribution with measurements)

In: 40 to 250 A
Protection: Distribution protection including Earth Leakage Alarm (LSI + Earth Leakage Alarm)
R: Adjustable leakage threshold ($I\Delta n$) and adjustable time delay threshold (Δt) by using the two dials on the green area of the trip
Energy management: the root cause of the fault (phase and interrupted current) is displayed additional to the compliance with the requirements of IEC 60364 8 1 dedicated to the optimization of energy efficiency.
 Micrologic 7.2 E provides a range of measurements with accuracies required for complex energy efficiency approaches.

> One identical frame size > 8 performance levels F, N, H, S, L, R (at 415 V) and 2 high performance levels R, HB1 and HB2 (at 690 V)



ComPacT
NSX400/630



ComPacT
NSX400/630

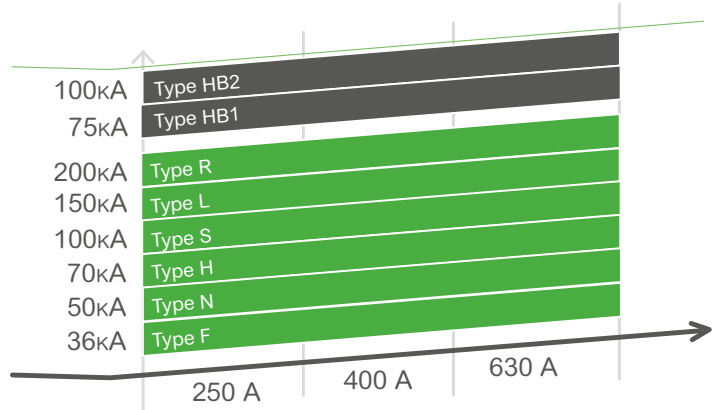

> Trip units for ComPacT NSX400/630

Electronic MicroLogic 1.3

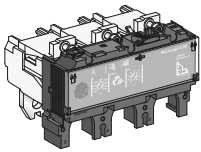

MicroLogic 1.3 - M

In: 320 to 500 A
Ii: instantaneous magnetic pick-up directly adjustable in Amps

Electronic MicroLogic 2

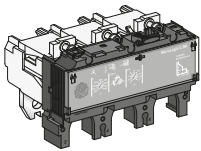

MicroLogic 2.3 - M
(Motors)

In: 320 to 500 A
Protection: LSI
Trip class: 5, 10, 20
Id: fixed phase unbalance pick-up (30%)

MicroLogic 2.3 - AB
(Service connection)

In: 400 A
Protection: LSI
Suitable for connection to LV public distribution network

Electronic MicroLogic 5/6

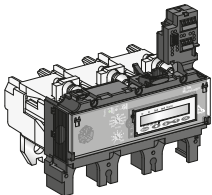

MicroLogic 5.3 E
(Distribution with measurements)

In: 400 to 630 A
Protection: LSI
Adjustable N protection on 4P devices via keypad: unprotected, N/2, N, OSN

MicroLogic 6.3 E
(same as 5.3 E + ground fault prot.)

In: 400 to 630 A
Protection: LSIG
G: Adjustable ground fault pick-up I_g and adjustable delay with I²t On/Off
Adjustable N protection on 4P devices via keypad: N/2, N, OSN

MicroLogic 6.3 E-M
(Motors + ground fault with E metering)

In: 320 to 500 A
Protection: LSIG with fine adjustment and display
Adjustable trip class: 5, 10, 20, 30
Adjustable phase unbalance I_{umb}, locked motor I_{jam}, underload I_{und} and long start I_{long} pick-ups and time delays

MicroLogic 5.3 - AZ
(16 Hz 2/3 networks)

In: 250 to 630 A
Protection: LSI with fine adjustment and display
3P only. Special sampling frequency and measurements for 16Hz 2/3 networks

Electronic Micrologic 4/7

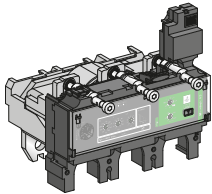

Micrologic 4.3
 (Distribution)

In: 250 to 570 A

Protection: LSIR with fine adjustment

R: Adjustable leakage threshold ($I\Delta n$) and adjustable time delay threshold (Δt) by using the two dials on the green area of the trip

Micrologic 4.3 AB
 (Distribution)

In: 250 to 570 A

Protection: LSIR with fine adjustment

R: Adjustable leakage threshold ($I\Delta n$) and adjustable time delay threshold (Δt) by using the two dials on the green area of the trip unit.

Compact ELCB equipped with that "new" earth leakage trip unit Micrologic AB are installed as an incoming device for installation connected with the public LV distribution system. With respect to the utility requirement,

Micrologic 4.3 AL
 (Distribution)

In: 250 to 570 A

Protection: Distribution protection including Earth Leakage Alarm (LSol + Earth Leakage)

R (alarm): Adjustable leakage threshold ($I\Delta n$) and adjustable time delay threshold (Δt) by using the two dials on the green area of the trip unit.

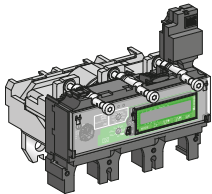

Micrologic 7.3 E
 (Distribution with measurements)

In: 250 to 570 A

Protection: Distribution protection including Earth Leakage Protection (LSIR)

R: Adjustable leakage threshold ($I\Delta n$) and adjustable time delay threshold (Δt) by using the two dials on the green area of the trip

Energy management:

the root cause of the fault (phase and interrupted current) is displayed additional to the compliance with the requirements of IEC 60364 8 1 dedicated to the optimization of energy efficiency.

Micrologic 7.2 E provides a range of measurements with accuracies required for complex energy efficiency approaches.

Micrologic 7.3 AL
 (Distribution with measurements)

In: 250 to 570 A

Protection: Distribution protection including Earth Leakage Alarm (LSI + Earth Leakage Alarm)

R: Adjustable leakage threshold ($I\Delta n$) and adjustable time delay threshold (Δt) by using the two dials on the green area of the trip

Energy management: the root cause of the fault (phase and interrupted current) is displayed additional to the compliance with the requirements of IEC 60364 8 1 dedicated to the optimization of energy efficiency.

Micrologic 7.2 E provides a range of measurements with accuracies required for complex energy efficiency approaches.

Substitution for ComPacT NSX100/160/250

ComPact NSX100/160/250



Thermal Magnetic 3P 2d

Rating (A)	Type	NSX100	NSX160	NSX250
16	TM16D	○		
25	TM25D	○		
32	TM32D	○		
40	TM40D	○		
50	TM50D	○		
63	TM63D	○		
80	TM80D	○	○	
100	TM100D	○	○	
125	TM125D		○	○
160	TM160D		○	○
200	TM200D			○
250	TM250D			○



Thermal Magnetic with Vigi Add-on

Rating (A)	Type	NSX100	NSX160	NSX250
16	TM16D	○		
25	TM25D	○		
32	TM32D	○		
40	TM40D	○		
50	TM50D	○		
63	TM63D	○		
80	TM80D	○	○	
100	TM100D	○	○	
125	TM125D		○	○
160	TM160D		○	○
200	TM200D			○
250	TM250D			○

New

ComPacT NSX100/160/250



Thermal Magnetic 3P 3d

Rating (A)	Type	NSX100	NSX160	NSX250
16	TM16D	○		
25	TM25D	○		
32	TM32D	○		
40	TM40D	○		
50	TM50D	○		
63	TM63D	○		
80	TM80D	○	○	
100	TM100D	○	○	
125	TM125D		○	○
160	TM160D		○	○
200	TM200D			○
250	TM250D			○



Electronic MicroLogic 4

Rating (A)	Type	NSXm	NSX250
25	Vigi 4.1	○	
50	Vigi 4.1	○	
100	Vigi 4.1	○	
160	Vigi 4.1	○	
250	Vigi 4.2		○

Substitution for ComPacT NSX100/160/250

ComPact NSX100/160/250



Electronic Micrologic 2.2 with Vigi Add-on

Rating (A)	NSX100	NSX160	NSX250
40	○	○	
100	○	○	○
160		○	○
250			○



Electronic Micrologic 2.2 M Complete Device F/N

Rating (A)	NSX100	NSX160	NSX250
25	○		
50	○		
100	○	○	
150		○	○
220			○



Electronic Micrologic 5/6 A

Rating (A)	NSX100	NSX160	NSX250
40	○		
100	○	○	○
160		○	○
250			○

New

ComPacT NSX100/160/250



Electronic MicroLogic 4.2

Rating (A)	NSX100	NSX160	NSX250
40	○	○	
100	○	○	○
160		○	○
250			○



Basic Frame

Breaking capacity

	NSX100	NSX160	NSX250
F	○	○	○
N	○	○	○

Electronic MicroLogic 2.2 M Trip Unit

Rating (A)	NSX100/160/250
25	○
50	○
100	○
160	○
250	○



Electronic MicroLogic 5/6 E

Rating (A)	NSX100	NSX250
40	○	
100	○	○
160		○
250		○

Breaker and Trip Unit Selection Substitution for ComPacT NSX400/630

ComPact NSX400/630



Electronic MicroLogic 2.3 with Vigti Add-on

Rating (A)	NSX400	NSX630
400	<input checked="" type="radio"/>	
630		<input type="radio"/>



Electronic MicroLogic 5/6 A

Rating (A)	NSX400	NSX630
400	<input checked="" type="radio"/>	
630		<input type="radio"/>

New

ComPacT NSX400/630



Electronic MicroLogic 4.3

Rating (A)	NSX400	NSX630
400	<input checked="" type="radio"/>	
570		<input type="radio"/>

OR



Basic Frame
Breaking capacity NSX400/630

F	<input checked="" type="radio"/>
N	<input checked="" type="radio"/>

+ Electronic MicroLogic
7.3 E Trip Unit

Rating (A)	NSX400/630
400	<input checked="" type="radio"/>
570	<input checked="" type="radio"/>



Electronic MicroLogic 5/6 E

Rating (A)	NSX400	NSX630
400	<input checked="" type="radio"/>	
630		<input type="radio"/>

Auxiliary Contacts and Voltage Releases

Except reference 29452, terminals are now spring type in order to ensure a fast connection. Commercial references remain unchanged.

Auxiliary contact, ref. 29450

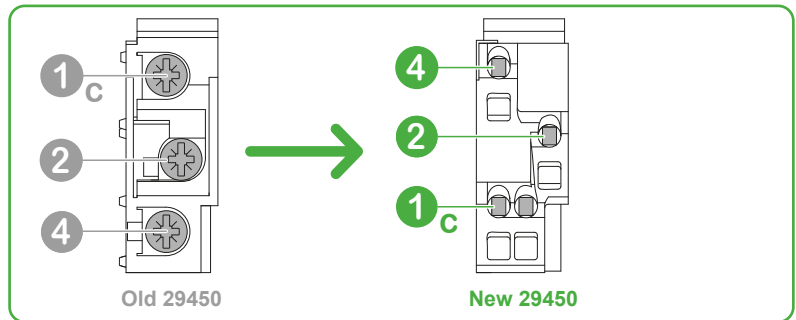
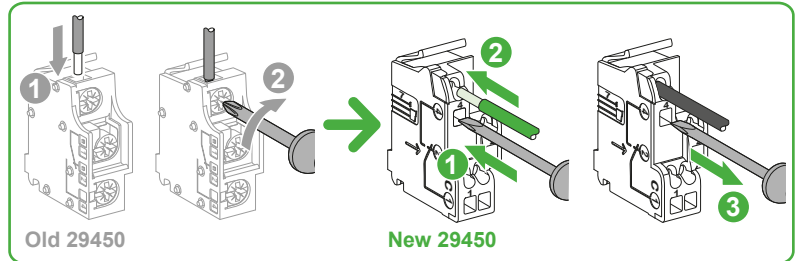

Auxiliary contact, ref. 29452: no change

Voltage releases, all references:

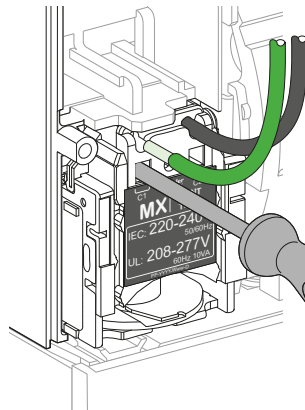

Substitution for Accessories ComPacT NSX100/160/250

ComPact NSX100/160/250

	Old NSX to New Retrofit NSX	New Retrofit NSX to old NSX
Direct rotary handles	Yes	Yes
Extended rotary handles	Yes	Yes

Direct Rotary Handles

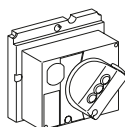

With black handle	LV429337
With red handle on yellow front	LV429339
MCC conversion accessory	LV429341
CNOMO conversion accessory	LV429342

Extended Rotary Handles

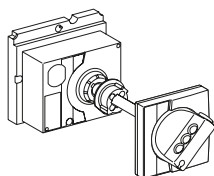

With black handle	LV429337
With red handle on yellow front	LV429339
MCC conversion accessory	LV429341
CNOMO conversion accessory	LV429342

New

ComPacT NSX100/160/250

Direct Rotary Handles

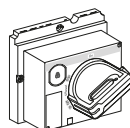

With black handle	LV429337T
With red handle on yellow front	LV429339T
MCC conversion accessory	LV429341T
CNOMO conversion accessory	LV429342T

Extended Rotary Handles

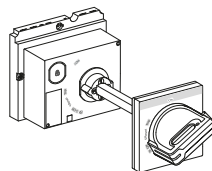

With black handle	LV429337T
With red handle on yellow front	LV429339T
MCC conversion accessory	LV429341T
CNOMO conversion accessory	LV429342T

Substitution for Accessories ComPacT NSX100/160/250

New

ComPact NSX100/160/250

Locks to Fixed

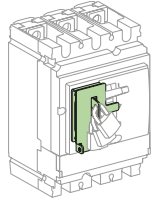

By fixed device for 3P 4P (open or close position)	LV429371
By fixed device for 3P 4P (open position only)	LV429370

Mechanical Interlocking for Circuit Breakers

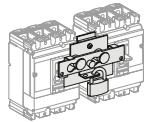

With toggles	LV429354
--------------	-----------------

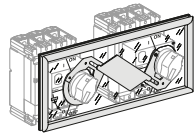

With rotary handles	LV429369
---------------------	-----------------

Escutcheon Collar

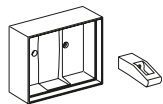

With toggle	LV429284
-------------	-----------------

ComPacT NSX100/160/250

Locks to Fixed

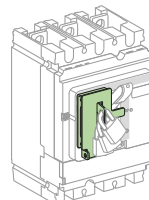

By fixed device for 3P 4P (open or close position)	LV429371T
By fixed device for 3P 4P (open position only)	LV429370T

Mechanical Interlocking for Circuit Breakers

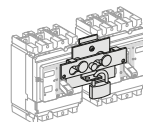

With toggles	LV429354T
--------------	------------------

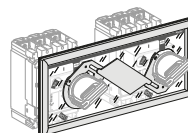

With direct rotary handles	LV429369T
With extended rotary handles	LV429369ET

Escutcheon Collar

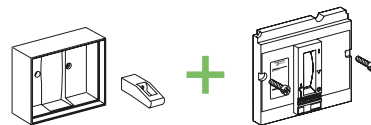

With toggle	LV429284
ComPacT NSX front cover	LV434435

Substitution for Accessories ComPacT NSX400/630

ComPact NSX400/630

	Old NSX to New Retrofit NSX	New Retrofit NSX to old NSX
Direct rotary handles	Yes	Yes
Extended rotary handles	Yes	Yes

Direct Rotary Handles

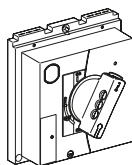

With black handle	LV432597
With red handle on yellow front	LV432599
MCC conversion accessory	LV432606
CNOMO conversion accessory	LV432602

Extended Rotary Handles

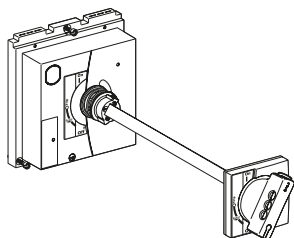

With black handle	LV432598
MCC conversion accessory	LV432600
With telescopic handle for withdrawable device	LV432603

New

ComPacT NSX400/630

Direct Rotary Handles

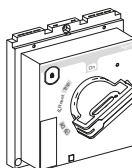

With black handle	LV432597T
With red handle on yellow front	LV432599T
MCC conversion accessory	LV432606T
CNOMO conversion accessory	LV432602T

Extended Rotary Handles

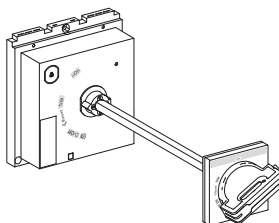

With black handle	LV432598T
MCC conversion accessory	LV432600T
With telescopic handle for withdrawable device	LV432603T

Substitution for Accessories ComPacT NSX400/630

ComPact NSX400/630

Mechanical Interlocking for Circuit Breakers

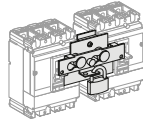

With toggles	LV432614
--------------	-----------------

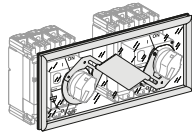

With rotary handles	LV432621
---------------------	-----------------

Escutcheon Collar

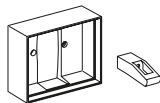

With toggle	LV432534
-------------	-----------------

Additional Toggle Extension for NSX400/630

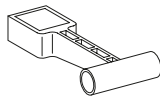

Additional toggle extension for NSX400/630	32595
--	--------------

New

ComPacT NSX400/630

Mechanical Interlocking for Circuit Breakers

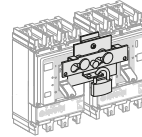

With toggles	LV432614T
--------------	------------------

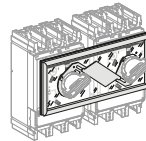

With direct rotary handles	LV432621T
With extended rotary handles	LV432621ET

Escutcheon Collar

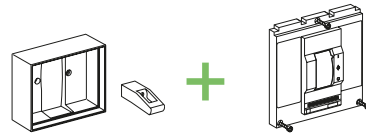

With toggle	LV432534
ComPacT NSX front cover	LV434436

Additional Toggle Extension for NSX400/630

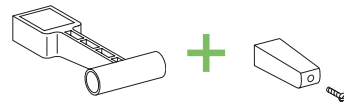

Additional toggle extension for NSX400/630	32595
Toggle extension	LV432553

New Generation, Simpler Commercial References

[Scan QR code for breaker updates](#)

Each breaker is equipped with a QR code that allows you to get the latest information on your breaker.

[New Meaningful References to Make your Life Easier](#)

We know any change in commercial references will be an adjustment, but in the long run we believe this change is needed, and will make your life easier.

For instance LV429630 will become C10F3TM100L
ComPacT Breaker NSX100F 36kA AC 3P3D 100A TMD with Everlink

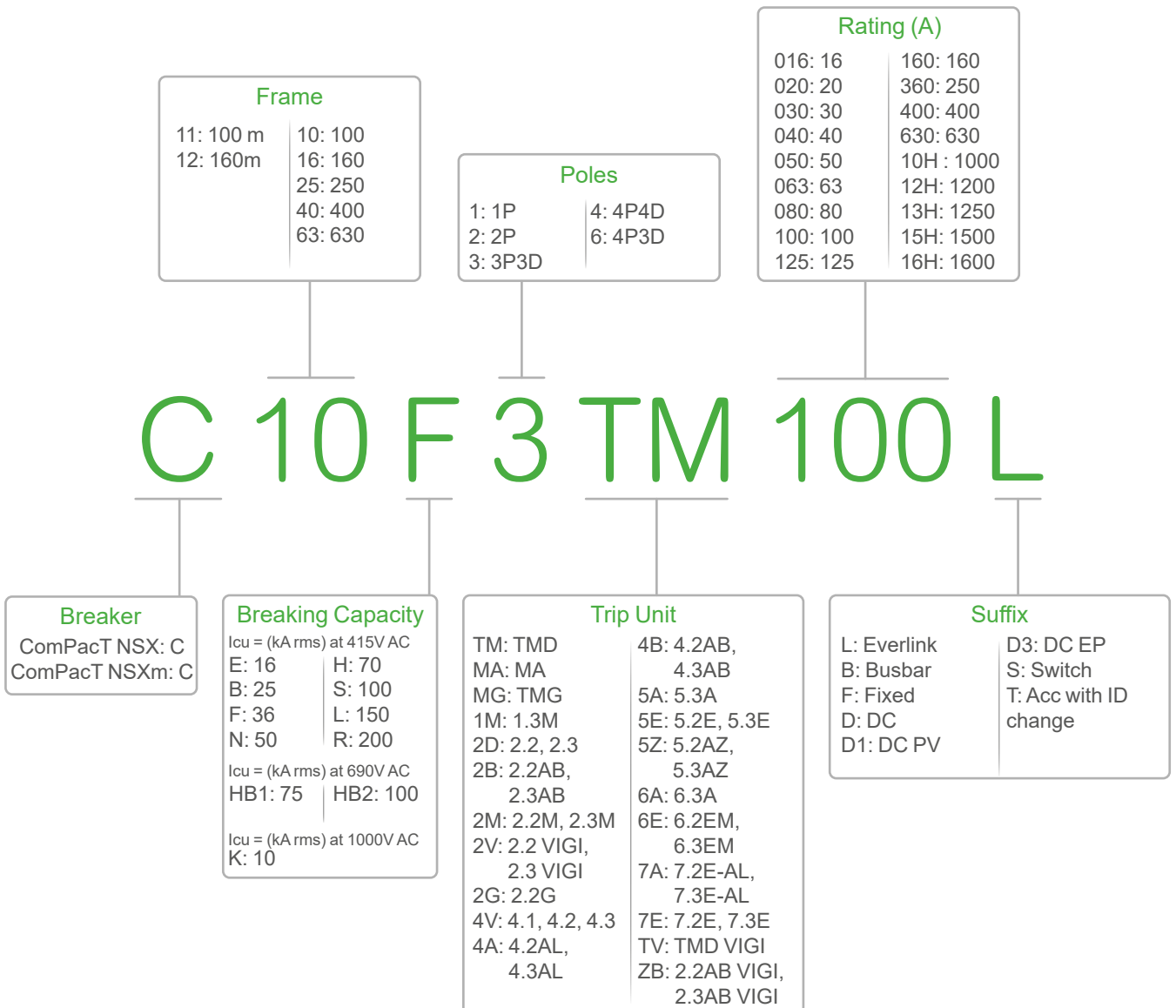

Compatibility of Components of Existing and New ComPacT NSXm

Old ComPact NSXm		New ComPacT NSXm		Compatibility	
Cat. No	Description	Cat. No	Description	Old NSXm to New Retrofit NSXm	New Retrofit NSXm to old NSXm
LV426100	Breaker NSXm 16kA TM16D 3P Elink	C11E3TM016L	NSXm100E 16kAAC 3P 16A TMD ELINK	Yes	Yes
LV426101	Breaker NSXm 16kA TM25D 3P Elink	C11E3TM025L	NSXm100E 16kAAC 3P 25A TMD ELINK	Yes	Yes
LV426102	Breaker NSXm 16kA TM32D 3P Elink	C11E3TM032L	NSXm100E 16kAAC 3P 32A TMD ELINK	Yes	Yes
LV426103	Breaker NSXm 16kA TM40D 3P Elink	C11E3TM040L	NSXm100E 16kAAC 3P 40A TMD ELINK	Yes	Yes
LV426104	Breaker NSXm 16kA TM50D 3P Elink	C11E3TM050L	NSXm100E 16kAAC 3P 50A TMD ELINK	Yes	Yes
LV426105	Breaker NSXm 16kA TM63D 3P Elink	C11E3TM063L	NSXm100E 16kAAC 3P 63A TMD ELINK	Yes	Yes
LV426106	Breaker NSXm 16kA TM80D 3P Elink	C11E3TM080L	NSXm100E 16kAAC 3P 80A TMD ELINK	Yes	Yes
LV426107	Breaker NSXm 16kA TM100D 3P Elink	C11E3TM100L	NSXm100E 16kAAC 3P 100A TMD ELINK	Yes	Yes
LV426108	Breaker NSXm 16kA TM125D 3P Elink	C12E3TM125L	NSXm160E 16kAAC 3P 125A TMD ELINK	Yes	Yes
LV426109	Breaker NSXm 16kA TM160D 3P Elink	C12E3TM160L	NSXm160E 16kAAC 3P 160A TMD ELINK	Yes	Yes
LV426110	Breaker NSXm 16kA TM16D 4P/3T Elink	C11E6TM016L	NSXm100E 16kAAC 4P3D 16A TMD ELINK	Yes	Yes
LV426111	Breaker NSXm 16kA TM25D 4P/3T Elink	C11E6TM025L	NSXm100E 16kAAC 4P3D 25A TMD ELINK	Yes	Yes
LV426112	Breaker NSXm 16kA TM32D 4P/3T Elink	C11E6TM032L	NSXm100E 16kAAC 4P3D 32A TMD ELINK	Yes	Yes
LV426113	Breaker NSXm 16kA TM40D 4P/3T Elink	C11E6TM040L	NSXm100E 16kAAC 4P3D 40A TMD ELINK	Yes	Yes
LV426114	Breaker NSXm 16kA TM50D 4P/3T Elink	C11E6TM050L	NSXm100E 16kAAC 4P3D 50A TMD ELINK	Yes	Yes
LV426115	Breaker NSXm 16kA TM63D 4P/3T Elink	C11E6TM063L	NSXm100E 16kAAC 4P3D 63A TMD ELINK	Yes	Yes
LV426116	Breaker NSXm 16kA TM80D 4P/3T Elink	C11E6TM080L	NSXm100E 16kAAC 4P3D 80A TMD ELINK	Yes	Yes
LV426117	Breaker NSXm 16kA TM100D 4P/3T Elink	C11E6TM100L	NSXm100E 16kAAC 4P3D 100A TMD ELINK	Yes	Yes
LV426118	Breaker NSXm 16kA TM125D 4P/3T Elink	C12E6TM125L	NSXm160E 16kAAC 4P3D 125A TMD ELINK	Yes	Yes
LV426119	Breaker NSXm 16kA TM160D 4P/3T Elink	C12E6TM160L	NSXm160E 16kAAC 4P3D 160A TMD ELINK	Yes	Yes
LV426120	Breaker NSXm 16kA TM16D 4P/4T Elink	C11E4TM016L	NSXm100E 16kAAC 4P4D 16A TMD ELINK	Yes	Yes
LV426121	Breaker NSXm 16kA TM25D 4P/4T Elink	C11E4TM025L	NSXm100E 16kAAC 4P4D 25A TMD ELINK	Yes	Yes
LV426122	Breaker NSXm 16kA TM32D 4P/4T Elink	C11E4TM032L	NSXm100E 16kAAC 4P4D 32A TMD ELINK	Yes	Yes
LV426123	Breaker NSXm 16kA TM40D 4P/4T Elink	C11E4TM040L	NSXm100E 16kAAC 4P4D 40A TMD ELINK	Yes	Yes
LV426124	Breaker NSXm 16kA TM50D 4P/4T Elink	C11E4TM050L	NSXm100E 16kAAC 4P4D 50A TMD ELINK	Yes	Yes
LV426125	Breaker NSXm 16kA TM63D 4P/4T Elink	C11E4TM063L	NSXm100E 16kAAC 4P4D 63A TMD ELINK	Yes	Yes
LV426126	Breaker NSXm 16kA TM80D 4P/4T Elink	C11E4TM080L	NSXm100E 16kAAC 4P4D 80A TMD ELINK	Yes	Yes
LV426127	Breaker NSXm 16kA TM100D 4P/4T Elink	C11E4TM100L	NSXm100E 16kAAC 4P4D 100A TMD ELINK	Yes	Yes
LV426128	Breaker NSXm 16kA TM125D 4P/4T Elink	C12E4TM125L	NSXm160E 16kAAC 4P4D 125A TMD ELINK	Yes	Yes
LV426129	Breaker NSXm 16kA TM160D 4P/4T Elink	C12E4TM160L	NSXm160E 16kAAC 4P4D 160A TMD ELINK	Yes	Yes
LV426150	Breaker NSXm 16kA TM16D 3P busbar	C11E3TM016B	NSXm100E 16kAAC 3P 16A TMD BUSBAR	Yes	Yes
LV426151	Breaker NSXm 16kA TM25D 3P busbar	C11E3TM025B	NSXm100E 16kAAC 3P 25A TMD BUSBAR	Yes	Yes
LV426152	Breaker NSXm 16kA TM32D3P busbar	C11E3TM032B	NSXm100E 16kAAC 3P 32A TMD BUSBAR	Yes	Yes
LV426153	Breaker NSXm 16kA TM40D 3P busbar	C11E3TM040B	NSXm100E 16kAAC 3P 40A TMD BUSBAR	Yes	Yes
LV426154	Breaker NSXm 16kA TM50D 3P busbar	C11E3TM050B	NSXm100E 16kAAC 3P 50A TMD BUSBAR	Yes	Yes
LV426155	Breaker NSXm 16kA TM63D 3P busbar	C11E3TM063B	NSXm100E 16kAAC 3P 63A TMD BUSBAR	Yes	Yes
LV426156	Breaker NSXm 16kA TM80D 3P busbar	C11E3TM080B	NSXm100E 16kAAC 3P 80A TMD BUSBAR	Yes	Yes
LV426157	Breaker NSXm 16kA TM100D 3P busbar	C11E3TM100B	NSXm100E 16kAAC 3P 100A TMD BUSBAR	Yes	Yes
LV426158	Breaker NSXm 16kA TM125D 3P busbar	C12E3TM125B	NSXm160E 16kAAC 3P 125A TMD BUSBAR	Yes	Yes
LV426159	Breaker NSXm 16kA TM160D 3P busbar	C12E3TM160B	NSXm160E 16kAAC 3P 160A TMD BUSBAR	Yes	Yes
LV426160	Breaker NSXm 16kA TM16D 4P/3T busbar	C11E6TM016B	NSXm100E 16kAAC 4P3D 16A TMD BUSBAR	Yes	Yes
LV426161	Breaker NSXm 16kA TM25D 4P/3T busbar	C11E6TM025B	NSXm100E 16kAAC 4P3D 25A TMD BUSBAR	Yes	Yes
LV426162	Breaker NSXm 16kA TM32D 4P/3T busbar	C11E6TM032B	NSXm100E 16kAAC 4P3D 32A TMD BUSBAR	Yes	Yes
LV426163	Breaker NSXm 16kA TM40D 4P/3T busbar	C11E6TM040B	NSXm100E 16kAAC 4P3D 40A TMD BUSBAR	Yes	Yes
LV426164	Breaker NSXm 16kA TM50D 4P/3T busbar	C11E6TM050B	NSXm100E 16kAAC 4P3D 50A TMD BUSBAR	Yes	Yes
LV426165	Breaker NSXm 16kA TM63D 4P/3T busbar	C11E6TM063B	NSXm100E 16kAAC 4P3D 63A TMD BUSBAR	Yes	Yes
LV426166	Breaker NSXm 16kA TM80D 4P/3T busbar	C11E6TM080B	NSXm100E 16kAAC 4P3D 80A TMD BUSBAR	Yes	Yes
LV426167	Breaker NSXm 16kA TM100D 4P/3T busbar	C11E6TM100B	NSXm100E 16kAAC 4P3D 100A TMD BUSBAR	Yes	Yes
LV426168	Breaker NSXm 16kA TM125D 4P/3T busbar	C12E6TM125B	NSXm160E 16kAAC 4P3D 125A TMD BUSBAR	Yes	Yes
LV426169	Breaker NSXm 16kA TM160D 4P/3T busbar	C12E6TM160B	NSXm160E 16kAAC 4P3D 160A TMD BUSBAR	Yes	Yes
LV426170	Breaker NSXm 16kA TM16D 4P/4T busbar	C11E4TM016B	NSXm100E 16kAAC 4P4D 16A TMD BUSBAR	Yes	Yes
LV426171	Breaker NSXm 16kA TM25D 4P/4T busbar	C11E4TM025B	NSXm100E 16kAAC 4P4D 25A TMD BUSBAR	Yes	Yes
LV426172	Breaker NSXm 16kA TM32D 4P/4T busbar	C11E4TM032B	NSXm100E 16kAAC 4P4D 32A TMD BUSBAR	Yes	Yes
LV426173	Breaker NSXm 16kA TM40D 4P/4T busbar	C11E4TM040B	NSXm100E 16kAAC 4P4D 40A TMD BUSBAR	Yes	Yes
LV426174	Breaker NSXm 16kA TM50D 4P/4T busbar	C11E4TM050B	NSXm100E 16kAAC 4P4D 50A TMD BUSBAR	Yes	Yes
LV426175	Breaker NSXm 16kA TM63D 4P/4T busbar	C11E4TM063B	NSXm100E 16kAAC 4P4D 63A TMD BUSBAR	Yes	Yes
LV426176	Breaker NSXm 16kA TM80D 4P/4T busbar	C11E4TM080B	NSXm100E 16kAAC 4P4D 80A TMD BUSBAR	Yes	Yes
LV426177	Breaker NSXm 16kA TM100D 4P/4T busbar	C11E4TM100B	NSXm100E 16kAAC 4P4D 100A TMD BUSBAR	Yes	Yes

Compatibility of Components of Existing and New ComPacT NSXm

Old ComPact NSXm		New ComPacT NSXm		Compatibility	
Cat. No	Description	Cat. No	Description	Old NSXm to New Retrofit NSXm	New Retrofit NSXm to old NSXm
LV426178	Breaker NSXm 16kA TM125D 4P/4T busbar	C12E4TM125B	NSXm160E 16kAAC 4P4D 125A TMD BUSBAR	Yes	Yes
LV426179	Breaker NSXm 16kA TM160D 4P/4T busbar	C12E4TM160B	NSXm160E 16kAAC 4P4D 160A TMD BUSBAR	Yes	Yes
LV426200	Breaker NSXm 25kA TM16D 3P Elink	C11B3TM016L	NSXm100B 25kAAC 3P 16A TMD ELINK	Yes	Yes
LV426201	Breaker NSXm 25kA TM25D 3P Elink	C11B3TM025L	NSXm100B 25kAAC 3P 25A TMD ELINK	Yes	Yes
LV426202	Breaker NSXm 25kA TM32D 3P Elink	C11B3TM032L	NSXm100B 25kAAC 3P 32A TMD ELINK	Yes	Yes
LV426203	Breaker NSXm 25kA TM40D 3P Elink	C11B3TM040L	NSXm100B 25kAAC 3P 40A TMD ELINK	Yes	Yes
LV426204	Breaker NSXm 25kA TM50D 3P Elink	C11B3TM050L	NSXm100B 25kAAC 3P 50A TMD ELINK	Yes	Yes
LV426205	Breaker NSXm 25kA TM63D 3P Elink	C11B3TM063L	NSXm100B 25kAAC 3P 63A TMD ELINK	Yes	Yes
LV426206	Breaker NSXm 25kA TM80D 3P Elink	C11B3TM080L	NSXm100B 25kAAC 3P 80A TMD ELINK	Yes	Yes
LV426207	Breaker NSXm 25kA TM100D 3P Elink	C11B3TM100L	NSXm100B 25kAAC 3P 100A TMD ELINK	Yes	Yes
LV426208	Breaker NSXm 25kA TM125D 3P Elink	C12B3TM125L	NSXm160B 25kAAC 3P 125A TMD ELINK	Yes	Yes
LV426209	Breaker NSXm 25kA TM160D 3P Elink	C12B3TM160L	NSXm160B 25kAAC 3P 160A TMD ELINK	Yes	Yes
LV426210	Breaker NSXm 25kA TM16D 4P/3T Elink	C11B6TM016L	NSXm100B 25kAAC 4P3D 16A TMD ELINK	Yes	Yes
LV426211	Breaker NSXm 25kA TM25D 4P/3T Elink	C11B6TM025L	NSXm100B 25kAAC 4P3D 25A TMD ELINK	Yes	Yes
LV426212	Breaker NSXm 25kA TM32D 4P/3T Elink	C11B6TM032L	NSXm100B 25kAAC 4P3D 32A TMD ELINK	Yes	Yes
LV426213	Breaker NSXm 25kA TM40D 4P/3T Elink	C11B6TM040L	NSXm100B 25kAAC 4P3D 40A TMD ELINK	Yes	Yes
LV426214	Breaker NSXm 25kA TM50D 4P/3T Elink	C11B6TM050L	NSXm100B 25kAAC 4P3D 50A TMD ELINK	Yes	Yes
LV426215	Breaker NSXm 25kA TM63D 4P/3T Elink	C11B6TM063L	NSXm100B 25kAAC 4P3D 63A TMD ELINK	Yes	Yes
LV426216	Breaker NSXm 25kA TM80D 4P/3T Elink	C11B6TM080L	NSXm100B 25kAAC 4P3D 80A TMD ELINK	Yes	Yes
LV426217	Breaker NSXm 25kA TM100D 4P/3T Elink	C11B6TM100L	NSXm100B 25kAAC 4P3D 100A TMD ELINK	Yes	Yes
LV426218	Breaker NSXm 25kA TM125D 4P/3T Elink	C12B6TM125L	NSXm160B 25kAAC 4P3D 125A TMD ELINK	Yes	Yes
LV426219	Breaker NSXm 25kA TM160D 4P/3T Elink	C12B6TM160L	NSXm160B 25kAAC 4P3D 160A TMD ELINK	Yes	Yes
LV426220	Breaker NSXm 25kA TM16D 4P/4T Elink	C11B4TM016L	NSXm100B 25kAAC 4P4D 16A TMD ELINK	Yes	Yes
LV426221	Breaker NSXm 25kA TM25D 4P/4T Elink	C11B4TM025L	NSXm100B 25kAAC 4P4D 25A TMD ELINK	Yes	Yes
LV426222	Breaker NSXm 25kA TM32D 4P/4T Elink	C11B4TM032L	NSXm100B 25kAAC 4P4D 32A TMD ELINK	Yes	Yes
LV426223	Breaker NSXm 25kA TM40D 4P/4T Elink	C11B4TM040L	NSXm100B 25kAAC 4P4D 40A TMD ELINK	Yes	Yes
LV426224	Breaker NSXm 25kA TM50D 4P/4T Elink	C11B4TM050L	NSXm100B 25kAAC 4P4D 50A TMD ELINK	Yes	Yes
LV426225	Breaker NSXm 25kA TM63D 4P/4T Elink	C11B4TM063L	NSXm100B 25kAAC 4P4D 63A TMD ELINK	Yes	Yes
LV426226	Breaker NSXm 25kA TM80D 4P/4T Elink	C11B4TM080L	NSXm100B 25kAAC 4P4D 80A TMD ELINK	Yes	Yes
LV426227	Breaker NSXm 25kA TM100D 4P/4T Elink	C11B4TM100L	NSXm100B 25kAAC 4P4D 100A TMD ELINK	Yes	Yes
LV426228	Breaker NSXm 25kA TM125D 4P/4T Elink	C12B4TM125L	NSXm160B 25kAAC 4P4D 125A TMD ELINK	Yes	Yes
LV426229	Breaker NSXm 25kA TM160D 4P/4T Elink	C12B4TM160L	NSXm160B 25kAAC 4P4D 160A TMD ELINK	Yes	Yes
LV426250	Breaker NSXm 25kA TM16D 3P busbar	C11B3TM016B	NSXm100B 25kAAC 3P 16A TMD BUSBAR	Yes	Yes
LV426251	Breaker NSXm 25kA TM25D 3P busbar	C11B3TM025B	NSXm100B 25kAAC 3P 25A TMD BUSBAR	Yes	Yes
LV426252	Breaker NSXm 25kA TM32D 3P busbar	C11B3TM032B	NSXm100B 25kAAC 3P 32A TMD BUSBAR	Yes	Yes
LV426253	Breaker NSXm 25kA TM40D 3P busbar	C11B3TM040B	NSXm100B 25kAAC 3P 40A TMD BUSBAR	Yes	Yes
LV426254	Breaker NSXm 25kA TM50D 3P busbar	C11B3TM050B	NSXm100B 25kAAC 3P 50A TMD BUSBAR	Yes	Yes
LV426255	Breaker NSXm 25kA TM63D 3P busbar	C11B3TM063B	NSXm100B 25kAAC 3P 63A TMD BUSBAR	Yes	Yes
LV426256	Breaker NSXm 25kA TM80D 3P busbar	C11B3TM080B	NSXm100B 25kAAC 3P 80A TMD BUSBAR	Yes	Yes
LV426257	Breaker NSXm 25kA TM100D 3P busbar	C11B3TM100B	NSXm100B 25kAAC 3P 100A TMD BUSBAR	Yes	Yes
LV426258	Breaker NSXm 25kA TM125D 3P busbar	C12B3TM125B	NSXm160B 25kAAC 3P 125A TMD BUSBAR	Yes	Yes
LV426259	Breaker NSXm 25kA TM160D 3P busbar	C12B3TM160B	NSXm160B 25kAAC 3P 160A TMD BUSBAR	Yes	Yes
LV426260	Breaker NSXm 25kA TM16D 4P/3T busbar	C11B6TM016B	NSXm100B 25kAAC 4P3D 16A TMD BUSBAR	Yes	Yes
LV426261	Breaker NSXm 25kA TM25D 4P/3T busbar	C11B6TM025B	NSXm100B 25kAAC 4P3D 25A TMD BUSBAR	Yes	Yes
LV426262	Breaker NSXm 25kA TM32D 4P/3T busbar	C11B6TM032B	NSXm100B 25kAAC 4P3D 32A TMD BUSBAR	Yes	Yes
LV426263	Breaker NSXm 25kA TM40D 4P/3T busbar	C11B6TM040B	NSXm100B 25kAAC 4P3D 40A TMD BUSBAR	Yes	Yes
LV426264	Breaker NSXm 25kA TM50D 4P/3T busbar	C11B6TM050B	NSXm100B 25kAAC 4P3D 50A TMD BUSBAR	Yes	Yes
LV426265	Breaker NSXm 25kA TM63D 4P/3T busbar	C11B6TM063B	NSXm100B 25kAAC 4P3D 63A TMD BUSBAR	Yes	Yes
LV426266	Breaker NSXm 25kA TM80D 4P/3T busbar	C11B6TM080B	NSXm100B 25kAAC 4P3D 80A TMD BUSBAR	Yes	Yes
LV426267	Breaker NSXm 25kA TM100D 4P/3T busbar	C11B6TM100B	NSXm100B 25kAAC 4P3D 100A TMD BUSBAR	Yes	Yes
LV426268	Breaker NSXm 25kA TM125D 4P/3T busbar	C12B6TM125B	NSXm160B 25kAAC 4P3D 125A TMD BUSBAR	Yes	Yes
LV426269	Breaker NSXm 25kA TM160D 4P/3T busbar	C12B6TM160B	NSXm160B 25kAAC 4P3D 160A TMD BUSBAR	Yes	Yes
LV426270	Breaker NSXm 25kA TM16D 4P/4T busbar	C11B4TM016B	NSXm100B 25kAAC 4P4D 16A TMD BUSBAR	Yes	Yes
LV426271	Breaker NSXm 25kA TM25D 4P/4T busbar	C11B4TM025B	NSXm100B 25kAAC 4P4D 25A TMD BUSBAR	Yes	Yes
LV426272	Breaker NSXm 25kA TM32D 4P/4T busbar	C11B4TM032B	NSXm100B 25kAAC 4P4D 32A TMD BUSBAR	Yes	Yes
LV426273	Breaker NSXm 25kA TM40D 4P/4T busbar	C11B4TM040B	NSXm100B 25kAAC 4P4D 40A TMD BUSBAR	Yes	Yes
LV426274	Breaker NSXm 25kA TM50D 4P/4T busbar	C11B4TM050B	NSXm100B 25kAAC 4P4D 50A TMD BUSBAR	Yes	Yes
LV426275	Breaker NSXm 25kA TM63D 4P/4T busbar	C11B4TM063B	NSXm100B 25kAAC 4P4D 63A TMD BUSBAR	Yes	Yes

Compatibility of Components of Existing and New ComPacT NSXm

Old ComPact NSXm		New ComPacT NSXm		Compatibility	
Cat. No	Description	Cat. No	Description	Old NSXm to New Retrofit NSXm	New Retrofit NSXm to old NSXm
LV426276	Breaker NSXm 25kA TM80D 4P/4T busbar	C11B4TM080B	NSXm100B 25kAAC 4P4D 80A TMD BUSBAR	Yes	Yes
LV426277	Breaker NSXm 25kA TM100D 4P/4T busbar	C11B4TM100B	NSXm100B 25kAAC 4P4D 100A TMD BUSBAR	Yes	Yes
LV426278	Breaker NSXm 25kA TM125D 4P/4T busbar	C12B4TM125B	NSXm160B 25kAAC 4P4D 125A TMD BUSBAR	Yes	Yes
LV426279	Breaker NSXm 25kA TM160D 4P/4T busbar	C12B4TM160B	NSXm160B 25kAAC 4P4D 160A TMD BUSBAR	Yes	Yes
LV426300	Breaker NSXm 36kA TM16D 3P Elink	C11F3TM016L	NSXm100F 36kAAC 3P 16A TMD ELINK	Yes	Yes
LV426301	Breaker NSXm 36kA TM25D 3P Elink	C11F3TM025L	NSXm100F 36kAAC 3P 25A TMD ELINK	Yes	Yes
LV426302	Breaker NSXm 36kA TM32D 3P Elink	C11F3TM032L	NSXm100F 36kAAC 3P 32A TMD ELINK	Yes	Yes
LV426303	Breaker NSXm 36kA TM40D 3P Elink	C11F3TM040L	NSXm100F 36kAAC 3P 40A TMD ELINK	Yes	Yes
LV426304	Breaker NSXm 36kA TM50D 3P Elink	C11F3TM050L	NSXm100F 36kAAC 3P 50A TMD ELINK	Yes	Yes
LV426305	Breaker NSXm 36kA TM63D 3P Elink	C11F3TM063L	NSXm100F 36kAAC 3P 63A TMD ELINK	Yes	Yes
LV426306	Breaker NSXm 36kA TM80D 3P Elink	C11F3TM080L	NSXm100F 36kAAC 3P 80A TMD ELINK	Yes	Yes
LV426307	Breaker NSXm 36kA TM100D 3P Elink	C11F3TM100L	NSXm100F 36kAAC 3P 100A TMD ELINK	Yes	Yes
LV426308	Breaker NSXm 36kA TM125D 3P Elink	C12F3TM125L	NSXm160F 36kAAC 3P 125A TMD ELINK	Yes	Yes
LV426309	Breaker NSXm 36kA TM160D 3P Elink	C12F3TM160L	NSXm160F 36kAAC 3P 160A TMD ELINK	Yes	Yes
LV426310	Breaker NSXm 36kA TM16D 4P/3T Elink	C11F6TM016L	NSXm100F 36kAAC 4P3D 16A TMD ELINK	Yes	Yes
LV426311	Breaker NSXm 36kA TM25D 4P/3T Elink	C11F6TM025L	NSXm100F 36kAAC 4P3D 25A TMD ELINK	Yes	Yes
LV426312	Breaker NSXm 36kA TM32D 4P/3T Elink	C11F6TM032L	NSXm100F 36kAAC 4P3D 32A TMD ELINK	Yes	Yes
LV426313	Breaker NSXm 36kA TM40D 4P/3T Elink	C11F6TM040L	NSXm100F 36kAAC 4P3D 40A TMD ELINK	Yes	Yes
LV426314	Breaker NSXm 36kA TM50D 4P/3T Elink	C11F6TM050L	NSXm100F 36kAAC 4P3D 50A TMD ELINK	Yes	Yes
LV426315	Breaker NSXm 36kA TM63D 4P/3T Elink	C11F6TM063L	NSXm100F 36kAAC 4P3D 63A TMD ELINK	Yes	Yes
LV426316	Breaker NSXm 36kA TM80D 4P/3T Elink	C11F6TM080L	NSXm100F 36kAAC 4P3D 80A TMD ELINK	Yes	Yes
LV426317	Breaker NSXm 36kA TM100D 4P/3T Elink	C11F6TM100L	NSXm100F 36kAAC 4P3D 100A TMD ELINK	Yes	Yes
LV426318	Breaker NSXm 36kA TM125D 4P/3T Elink	C12F6TM125L	NSXm160F 36kAAC 4P3D 125A TMD ELINK	Yes	Yes
LV426319	Breaker NSXm 36kA TM160D 4P/3T Elink	C12F6TM160L	NSXm160F 36kAAC 4P3D 160A TMD ELINK	Yes	Yes
LV426320	Breaker NSXm 36kA TM16D 4P/4T Elink	C11F4TM016L	NSXm100F 36kAAC 4P4D 16A TMD ELINK	Yes	Yes
LV426321	Breaker NSXm 36kA TM25D 4P/4T Elink	C11F4TM025L	NSXm100F 36kAAC 4P4D 25A TMD ELINK	Yes	Yes
LV426322	Breaker NSXm 36kA TM32D 4P/4T Elink	C11F4TM032L	NSXm100F 36kAAC 4P4D 32A TMD ELINK	Yes	Yes
LV426323	Breaker NSXm 36kA TM40D 4P/4T Elink	C11F4TM040L	NSXm100F 36kAAC 4P4D 40A TMD ELINK	Yes	Yes
LV426324	Breaker NSXm 36kA TM50D 4P/4T Elink	C11F4TM050L	NSXm100F 36kAAC 4P4D 50A TMD ELINK	Yes	Yes
LV426325	Breaker NSXm 36kA TM63D 4P/4T Elink	C11F4TM063L	NSXm100F 36kAAC 4P4D 63A TMD ELINK	Yes	Yes
LV426326	Breaker NSXm 36kA TM80D 4P/4T Elink	C11F4TM080L	NSXm100F 36kAAC 4P4D 80A TMD ELINK	Yes	Yes
LV426327	Breaker NSXm 36kA TM100D 4P/4T Elink	C11F4TM100L	NSXm100F 36kAAC 4P4D 100A TMD ELINK	Yes	Yes
LV426328	Breaker NSXm 36kA TM125D 4P/4T Elink	C12F4TM125L	NSXm160F 36kAAC 4P4D 125A TMD ELINK	Yes	Yes
LV426329	Breaker NSXm 36kA TM160D 4P/4T Elink	C12F4TM160L	NSXm160F 36kAAC 4P4D 160A TMD ELINK	Yes	Yes
LV426350	Breaker NSXm 36kA TM16D 3P busbar	C11F3TM016B	NSXm100F 36kAAC 3P 16A TMD BUSBAR	Yes	Yes
LV426351	Breaker NSXm 36kA TM25D 3P busbar	C11F3TM025B	NSXm100F 36kAAC 3P 25A TMD BUSBAR	Yes	Yes
LV426352	Breaker NSXm 36kA TM32D 3P busbar	C11F3TM032B	NSXm100F 36kAAC 3P 32A TMD BUSBAR	Yes	Yes
LV426353	Breaker NSXm 36kA TM40D 3P busbar	C11F3TM040B	NSXm100F 36kAAC 3P 40A TMD BUSBAR	Yes	Yes
LV426354	Breaker NSXm 36kA TM50D 3P busbar	C11F3TM050B	NSXm100F 36kAAC 3P 50A TMD BUSBAR	Yes	Yes
LV426355	Breaker NSXm 36kA TM63D 3P busbar	C11F3TM063B	NSXm100F 36kAAC 3P 63A TMD BUSBAR	Yes	Yes
LV426356	Breaker NSXm 36kA TM80D 3P busbar	C11F3TM080B	NSXm100F 36kAAC 3P 80A TMD BUSBAR	Yes	Yes
LV426357	Breaker NSXm 36kA TM100D 3P busbar	C11F3TM100B	NSXm100F 36kAAC 3P 100A TMD BUSBAR	Yes	Yes
LV426358	Breaker NSXm 36kA TM125D 3P busbar	C12F3TM125B	NSXm160F 36kAAC 3P 125A TMD BUSBAR	Yes	Yes
LV426359	Breaker NSXm 36kA TM160D 3P busbar	C12F3TM160B	NSXm160F 36kAAC 3P 160A TMD BUSBAR	Yes	Yes
LV426360	Breaker NSXm 36kA TM16D 4P/3T busbar	C11F6TM016B	NSXm100F 36kAAC 4P3D 16A TMD BUSBAR	Yes	Yes
LV426361	Breaker NSXm 36kA TM25D 4P/3T busbar	C11F6TM025B	NSXm100F 36kAAC 4P3D 25A TMD BUSBAR	Yes	Yes
LV426362	Breaker NSXm 36kA TM32D 4P/3T busbar	C11F6TM032B	NSXm100F 36kAAC 4P3D 32A TMD BUSBAR	Yes	Yes
LV426363	Breaker NSXm 36kA TM40D 4P/3T busbar	C11F6TM040B	NSXm100F 36kAAC 4P3D 40A TMD BUSBAR	Yes	Yes
LV426364	Breaker NSXm 36kA TM50D 4P/3T busbar	C11F6TM050B	NSXm100F 36kAAC 4P3D 50A TMD BUSBAR	Yes	Yes
LV426365	Breaker NSXm 36kA TM63D 4P/3T busbar	C11F6TM063B	NSXm100F 36kAAC 4P3D 63A TMD BUSBAR	Yes	Yes
LV426366	Breaker NSXm 36kA TM80D 4P/3T busbar	C11F6TM080B	NSXm100F 36kAAC 4P3D 80A TMD BUSBAR	Yes	Yes
LV426367	Breaker NSXm 36kA TM100D 4P/3T busbar	C11F6TM100B	NSXm100F 36kAAC 4P3D 100A TMD BUSBAR	Yes	Yes
LV426368	Breaker NSXm 36kA TM125D 4P/3T busbar	C12F6TM125B	NSXm160F 36kAAC 4P3D 125A TMD BUSBAR	Yes	Yes
LV426369	Breaker NSXm 36kA TM160D 4P/3T busbar	C12F6TM160B	NSXm160F 36kAAC 4P3D 160A TMD BUSBAR	Yes	Yes
LV426370	Breaker NSXm 36kA TM16D 4P/4T busbar	C11F4TM016B	NSXm100F 36kAAC 4P4D 16A TMD BUSBAR	Yes	Yes
LV426371	Breaker NSXm 36kA TM25D 4P/4T busbar	C11F4TM025B	NSXm100F 36kAAC 4P4D 25A TMD BUSBAR	Yes	Yes
LV426372	Breaker NSXm 36kA TM32D 4P/4T busbar	C11F4TM032B	NSXm100F 36kAAC 4P4D 32A TMD BUSBAR	Yes	Yes
LV426373	Breaker NSXm 36kA TM40D 4P/4T busbar	C11F4TM040B	NSXm100F 36kAAC 4P4D 40A TMD BUSBAR	Yes	Yes

Compatibility of Components of Existing and New ComPacT NSXm

Old ComPact NSXm		New ComPacT NSXm		Compatibility	
Cat. No	Description	Cat. No	Description	Old NSXm to New Retrofit NSXm	New Retrofit NSXm to old NSXm
LV426374	Breaker NSXm 36kA TM50D 4P/4T busbar	C11F4TM050B	NSXm100F 36kAAC 4P4D 50A TMD BUSBAR	Yes	Yes
LV426375	Breaker NSXm 36kA TM63D 4P/4T busbar	C11F4TM063B	NSXm100F 36kAAC 4P4D 63A TMD BUSBAR	Yes	Yes
LV426376	Breaker NSXm 36kA TM80D 4P/4T busbar	C11F4TM080B	NSXm100F 36kAAC 4P4D 80A TMD BUSBAR	Yes	Yes
LV426377	Breaker NSXm 36kA TM100D 4P/4T busbar	C11F4TM100B	NSXm100F 36kAAC 4P4D 100A TMD BUSBAR	Yes	Yes
LV426378	Breaker NSXm 36kA TM125D 4P/4T busbar	C12F4TM125B	NSXm160F 36kAAC 4P4D 125A TMD BUSBAR	Yes	Yes
LV426379	Breaker NSXm 36kA TM160D 4P/4T busbar	C12F4TM160B	NSXm160F 36kAAC 4P4D 160A TMD BUSBAR	Yes	Yes
LV426400	Breaker NSXm 50kA TM16D 3P Elink	C11N3TM016L	NSXm100N 50kAAC 3P 16A TMD ELINK	Yes	Yes
LV426401	Breaker NSXm 50kA TM25D 3P Elink	C11N3TM025L	NSXm100N 50kAAC 3P 25A TMD ELINK	Yes	Yes
LV426402	Breaker NSXm 50kA TM32D 3P Elink	C11N3TM032L	NSXm100N 50kAAC 3P 32A TMD ELINK	Yes	Yes
LV426403	Breaker NSXm 50kA TM40D 3P Elink	C11N3TM040L	NSXm100N 50kAAC 3P 40A TMD ELINK	Yes	Yes
LV426404	Breaker NSXm 50kA TM50D 3P Elink	C11N3TM050L	NSXm100N 50kAAC 3P 50A TMD ELINK	Yes	Yes
LV426405	Breaker NSXm 50kA TM63D 3P Elink	C11N3TM063L	NSXm100N 50kAAC 3P 63A TMD ELINK	Yes	Yes
LV426406	Breaker NSXm 50kA TM80D 3P Elink	C11N3TM080L	NSXm100N 50kAAC 3P 80A TMD ELINK	Yes	Yes
LV426407	Breaker NSXm 50kA TM100D 3P Elink	C11N3TM100L	NSXm100N 50kAAC 3P 100A TMD ELINK	Yes	Yes
LV426408	Breaker NSXm 50kA TM125D 3P Elink	C12N3TM125L	NSXm160N 50kAAC 3P 125A TMD ELINK	Yes	Yes
LV426409	Breaker NSXm 50kA TM160D 3P Elink	C12N3TM160L	NSXm160N 50kAAC 3P 160A TMD ELINK	Yes	Yes
LV426410	Breaker NSXm 50kA TM16D 4P/3T Elink	C11N6TM016L	NSXm100N 50kAAC 4P3D 16A TMD ELINK	Yes	Yes
LV426411	Breaker NSXm 50kA TM25D 4P/3T Elink	C11N6TM025L	NSXm100N 50kAAC 4P3D 25A TMD ELINK	Yes	Yes
LV426412	Breaker NSXm 50kA TM32D 4P/3T Elink	C11N6TM032L	NSXm100N 50kAAC 4P3D 32A TMD ELINK	Yes	Yes
LV426413	Breaker NSXm 50kA TM40D 4P/3T Elink	C11N6TM040L	NSXm100N 50kAAC 4P3D 40A TMD ELINK	Yes	Yes
LV426414	Breaker NSXm 50kA TM50D 4P/3T Elink	C11N6TM050L	NSXm100N 50kAAC 4P3D 50A TMD ELINK	Yes	Yes
LV426415	Breaker NSXm 50kA TM63D 4P/3T Elink	C11N6TM063L	NSXm100N 50kAAC 4P3D 63A TMD ELINK	Yes	Yes
LV426416	Breaker NSXm 50kA TM80D 4P/3T Elink	C11N6TM080L	NSXm100N 50kAAC 4P3D 80A TMD ELINK	Yes	Yes
LV426417	Breaker NSXm 50kA TM100D 4P/3T Elink	C11N6TM100L	NSXm100N 50kAAC 4P3D 100A TMD ELINK	Yes	Yes
LV426418	Breaker NSXm 50kA TM125D 4P/3T Elink	C12N6TM125L	NSXm160N 50kAAC 4P3D 125A TMD ELINK	Yes	Yes
LV426419	Breaker NSXm 50kA TM160D 4P/3T Elink	C12N6TM160L	NSXm160N 50kAAC 4P3D 160A TMD ELINK	Yes	Yes
LV426420	Breaker NSXm 50kA TM16D 4P/4T Elink	C11N4TM016L	NSXm100N 50kAAC 4P4D 16A TMD ELINK	Yes	Yes
LV426421	Breaker NSXm 50kA TM25D 4P/4T Elink	C11N4TM025L	NSXm100N 50kAAC 4P4D 25A TMD ELINK	Yes	Yes
LV426422	Breaker NSXm 50kA TM32D 4P/4T Elink	C11N4TM032L	NSXm100N 50kAAC 4P4D 32A TMD ELINK	Yes	Yes
LV426423	Breaker NSXm 50kA TM40D 4P/4T Elink	C11N4TM040L	NSXm100N 50kAAC 4P4D 40A TMD ELINK	Yes	Yes
LV426424	Breaker NSXm 50kA TM50D 4P/4T Elink	C11N4TM050L	NSXm100N 50kAAC 4P4D 50A TMD ELINK	Yes	Yes
LV426425	Breaker NSXm 50kA TM63D 4P/4T Elink	C11N4TM063L	NSXm100N 50kAAC 4P4D 63A TMD ELINK	Yes	Yes
LV426426	Breaker NSXm 50kA TM80D 4P/4T Elink	C11N4TM080L	NSXm100N 50kAAC 4P4D 80A TMD ELINK	Yes	Yes
LV426427	Breaker NSXm 50kA TM100D 4P/4T Elink	C11N4TM100L	NSXm100N 50kAAC 4P4D 100A TMD ELINK	Yes	Yes
LV426428	Breaker NSXm 50kA TM125D 4P/4T Elink	C12N4TM125L	NSXm160N 50kAAC 4P4D 125A TMD ELINK	Yes	Yes
LV426429	Breaker NSXm 50kA TM160D 4P/4T Elink	C12N4TM160L	NSXm160N 50kAAC 4P4D 160A TMD ELINK	Yes	Yes
LV426450	Breaker NSXm 50kA TM16D 3P busbar	C11N3TM016B	NSXm100N 50kAAC 3P 16A TMD BUSBAR	Yes	Yes
LV426451	Breaker NSXm 50kA TM25D 3P busbar	C11N3TM025B	NSXm100N 50kAAC 3P 25A TMD BUSBAR	Yes	Yes
LV426452	Breaker NSXm 50kA TM32D 3P busbar	C11N3TM032B	NSXm100N 50kAAC 3P 32A TMD BUSBAR	Yes	Yes
LV426453	Breaker NSXm 50kA TM40D 3P busbar	C11N3TM040B	NSXm100N 50kAAC 3P 40A TMD BUSBAR	Yes	Yes
LV426454	Breaker NSXm 50kA TM50D 3P busbar	C11N3TM050B	NSXm100N 50kAAC 3P 50A TMD BUSBAR	Yes	Yes
LV426455	Breaker NSXm 50kA TM63D 3P busbar	C11N3TM063B	NSXm100N 50kAAC 3P 63A TMD BUSBAR	Yes	Yes
LV426456	Breaker NSXm 50kA TM80D 3P busbar	C11N3TM080B	NSXm100N 50kAAC 3P 80A TMD BUSBAR	Yes	Yes
LV426457	Breaker NSXm 50kA TM100D 3P busbar	C11N3TM100B	NSXm100N 50kAAC 3P 100A TMD BUSBAR	Yes	Yes
LV426458	Breaker NSXm 50kA TM125D 3P busbar	C12N3TM125B	NSXm160N 50kAAC 3P 125A TMD BUSBAR	Yes	Yes
LV426459	Breaker NSXm 50kA TM160D 3P busbar	C12N3TM160B	NSXm160N 50kAAC 3P 160A TMD BUSBAR	Yes	Yes
LV426460	Breaker NSXm 50kA TM16D 4P/3T busbar	C11N6TM016B	NSXm100N 50kAAC 4P3D 16A TMD BUSBAR	Yes	Yes
LV426461	Breaker NSXm 50kA TM25D 4P/3T busbar	C11N6TM025B	NSXm100N 50kAAC 4P3D 25A TMD BUSBAR	Yes	Yes
LV426462	Breaker NSXm 50kA TM32D 4P/3T busbar	C11N6TM032B	NSXm100N 50kAAC 4P3D 32A TMD BUSBAR	Yes	Yes
LV426463	Breaker NSXm 50kA TM40D 4P/3T busbar	C11N6TM040B	NSXm100N 50kAAC 4P3D 40A TMD BUSBAR	Yes	Yes
LV426464	Breaker NSXm 50kA TM50D 4P/3T busbar	C11N6TM050B	NSXm100N 50kAAC 4P3D 50A TMD BUSBAR	Yes	Yes
LV426465	Breaker NSXm 50kA TM63D 4P/3T busbar	C11N6TM063B	NSXm100N 50kAAC 4P3D 63A TMD BUSBAR	Yes	Yes
LV426466	Breaker NSXm 50kA TM80D 4P/3T busbar	C11N6TM080B	NSXm100N 50kAAC 4P3D 80A TMD BUSBAR	Yes	Yes
LV426467	Breaker NSXm 50kA TM100D 4P/3T busbar	C11N6TM100B	NSXm100N 50kAAC 4P3D 100A TMD BUSBAR	Yes	Yes
LV426468	Breaker NSXm 50kA TM125D 4P/3T busbar	C12N6TM125B	NSXm160N 50kAAC 4P3D 125A TMD BUSBAR	Yes	Yes
LV426469	Breaker NSXm 50kA TM160D 4P/3T busbar	C12N6TM160B	NSXm160N 50kAAC 4P3D 160A TMD BUSBAR	Yes	Yes
LV426470	Breaker NSXm 50kA TM16D 4P/4T busbar	C11N4TM016B	NSXm100N 50kAAC 4P4D 16A TMD BUSBAR	Yes	Yes
LV426471	Breaker NSXm 50kA TM25D 4P/4T busbar	C11N4TM025B	NSXm100N 50kAAC 4P4D 25A TMD BUSBAR	Yes	Yes

Compatibility of Components of Existing and New ComPacT NSXm

Old ComPact NSXm		New ComPacT NSXm		Compatibility	
Cat. No	Description	Cat. No	Description	Old NSXm to New Retrofit NSXm	New Retrofit NSXm to old NSXm
LV426472	Breaker NSXm 50kA TM32D 4P/4T busbar	C11N4TM032B	NSXm100N 50kAAC 4P4D 32A TMD BUSBAR	Yes	Yes
LV426473	Breaker NSXm 50kA TM40D 4P/4T busbar	C11N4TM040B	NSXm100N 50kAAC 4P4D 40A TMD BUSBAR	Yes	Yes
LV426474	Breaker NSXm 50kA TM50D 4P/4T busbar	C11N4TM050B	NSXm100N 50kAAC 4P4D 50A TMD BUSBAR	Yes	Yes
LV426475	Breaker NSXm 50kA TM63D 4P/4T busbar	C11N4TM063B	NSXm100N 50kAAC 4P4D 63A TMD BUSBAR	Yes	Yes
LV426476	Breaker NSXm 50kA TM80D 4P/4T busbar	C11N4TM080B	NSXm100N 50kAAC 4P4D 80A TMD BUSBAR	Yes	Yes
LV426477	Breaker NSXm 50kA TM100D 4P/4T busbar	C11N4TM100B	NSXm100N 50kAAC 4P4D 100A TMD BUSBAR	Yes	Yes
LV426478	Breaker NSXm 50kA TM125D 4P/4T busbar	C12N4TM125B	NSXm160N 50kAAC 4P4D 125A TMD BUSBAR	Yes	Yes
LV426479	Breaker NSXm 50kA TM160D 4P/4T busbar	C12N4TM160B	NSXm160N 50kAAC 4P4D 160A TMD BUSBAR	Yes	Yes
LV426500	Breaker NSXm 70kA TM16D 3P Elink	C11H3TM016L	NSXm100H 70kAAC 3P 16A TMD ELINK	Yes	Yes
LV426501	Breaker NSXm 70kA TM25D 3P Elink	C11H3TM025L	NSXm100H 70kAAC 3P 25A TMD ELINK	Yes	Yes
LV426502	Breaker NSXm 70kA TM32D 3P Elink	C11H3TM032L	NSXm100H 70kAAC 3P 32A TMD ELINK	Yes	Yes
LV426503	Breaker NSXm 70kA TM40D 3P Elink	C11H3TM040L	NSXm100H 70kAAC 3P 40A TMD ELINK	Yes	Yes
LV426504	Breaker NSXm 70kA TM50D 3P Elink	C11H3TM050L	NSXm100H 70kAAC 3P 50A TMD ELINK	Yes	Yes
LV426505	Breaker NSXm 70kA TM63D 3P Elink	C11H3TM063L	NSXm100H 70kAAC 3P 63A TMD ELINK	Yes	Yes
LV426506	Breaker NSXm 70kA TM80D 3P Elink	C11H3TM080L	NSXm100H 70kAAC 3P 80A TMD ELINK	Yes	Yes
LV426507	Breaker NSXm 70kA TM100D 3P Elink	C11H3TM100L	NSXm100H 70kAAC 3P 100A TMD ELINK	Yes	Yes
LV426508	Breaker NSXm 70kA TM125D 3P Elink	C12H3TM125L	NSXm160H 70kAAC 3P 125A TMD ELINK	Yes	Yes
LV426509	Breaker NSXm 70kA TM160D 3P Elink	C12H3TM160L	NSXm160H 70kAAC 3P 160A TMD ELINK	Yes	Yes
LV426510	Breaker NSXm 70kA TM16D 4P/3T Elink	C11H6TM016L	NSXm100H 70kAAC 4P3D 16A TMD ELINK	Yes	Yes
LV426511	Breaker NSXm 70kA TM25D 4P/3T Elink	C11H6TM025L	NSXm100H 70kAAC 4P3D 25A TMD ELINK	Yes	Yes
LV426512	Breaker NSXm 70kA TM32D 4P/3T Elink	C11H6TM032L	NSXm100H 70kAAC 4P3D 32A TMD ELINK	Yes	Yes
LV426513	Breaker NSXm 70kA TM40D 4P/3T Elink	C11H6TM040L	NSXm100H 70kAAC 4P3D 40A TMD ELINK	Yes	Yes
LV426514	Breaker NSXm 70kA TM50D 4P/3T Elink	C11H6TM050L	NSXm100H 70kAAC 4P3D 50A TMD ELINK	Yes	Yes
LV426515	Breaker NSXm 70kA TM63D 4P/3T Elink	C11H6TM063L	NSXm100H 70kAAC 4P3D 63A TMD ELINK	Yes	Yes
LV426516	Breaker NSXm 70kA TM80D 4P/3T Elink	C11H6TM080L	NSXm100H 70kAAC 4P3D 80A TMD ELINK	Yes	Yes
LV426517	Breaker NSXm 70kA TM100D 4P/3T Elink	C11H6TM100L	NSXm100H 70kAAC 4P3D 100A TMD ELINK	Yes	Yes
LV426518	Breaker NSXm 70kA TM125D 4P/3T Elink	C12H6TM125L	NSXm160H 70kAAC 4P3D 125A TMD ELINK	Yes	Yes
LV426519	Breaker NSXm 70kA TM160D 4P/3T Elink	C12H6TM160L	NSXm160H 70kAAC 4P3D 160A TMD ELINK	Yes	Yes
LV426520	Breaker NSXm 70kA TM16D 4P/4T Elink	C11H4TM016L	NSXm100H 70kAAC 4P4D 16A TMD ELINK	Yes	Yes
LV426521	Breaker NSXm 70kA TM25D 4P/4T Elink	C11H4TM025L	NSXm100H 70kAAC 4P4D 25A TMD ELINK	Yes	Yes
LV426522	Breaker NSXm 70kA TM32D 4P/4T Elink	C11H4TM032L	NSXm100H 70kAAC 4P4D 32A TMD ELINK	Yes	Yes
LV426523	Breaker NSXm 70kA TM40D 4P/4T Elink	C11H4TM040L	NSXm100H 70kAAC 4P4D 40A TMD ELINK	Yes	Yes
LV426524	Breaker NSXm 70kA TM50D 4P/4T Elink	C11H4TM050L	NSXm100H 70kAAC 4P4D 50A TMD ELINK	Yes	Yes
LV426525	Breaker NSXm 70kA TM63D 4P/4T Elink	C11H4TM063L	NSXm100H 70kAAC 4P4D 63A TMD ELINK	Yes	Yes
LV426526	Breaker NSXm 70kA TM80D 4P/4T Elink	C11H4TM080L	NSXm100H 70kAAC 4P4D 80A TMD ELINK	Yes	Yes
LV426527	Breaker NSXm 70kA TM100D 4P/4T Elink	C11H4TM100L	NSXm100H 70kAAC 4P4D 100A TMD ELINK	Yes	Yes
LV426528	Breaker NSXm 70kA TM125D 4P/4T Elink	C12H4TM125L	NSXm160H 70kAAC 4P4D 125A TMD ELINK	Yes	Yes
LV426529	Breaker NSXm 70kA TM160D 4P/4T Elink	C12H4TM160L	NSXm160H 70kAAC 4P4D 160A TMD ELINK	Yes	Yes
LV426550	Breaker NSXm 70kA TM16D 3P busbar	C11H3TM016B	NSXm100H 70kAAC 3P 16A TMD BUSBAR	Yes	Yes
LV426551	Breaker NSXm 70kA TM25D 3P busbar	C11H3TM025B	NSXm100H 70kAAC 3P 25A TMD BUSBAR	Yes	Yes
LV426552	Breaker NSXm 70kA TM32D 3P busbar	C11H3TM032B	NSXm100H 70kAAC 3P 32A TMD BUSBAR	Yes	Yes
LV426553	Breaker NSXm 70kA TM40D 3P busbar	C11H3TM040B	NSXm100H 70kAAC 3P 40A TMD BUSBAR	Yes	Yes
LV426554	Breaker NSXm 70kA TM50D 3P busbar	C11H3TM050B	NSXm100H 70kAAC 3P 50A TMD BUSBAR	Yes	Yes
LV426555	Breaker NSXm 70kA TM63D 3P busbar	C11H3TM063B	NSXm100H 70kAAC 3P 63A TMD BUSBAR	Yes	Yes
LV426556	Breaker NSXm 70kA TM80D 3P busbar	C11H3TM080B	NSXm100H 70kAAC 3P 80A TMD BUSBAR	Yes	Yes
LV426557	Breaker NSXm 70kA TM100D 3P busbar	C11H3TM100B	NSXm100H 70kAAC 3P 100A TMD BUSBAR	Yes	Yes
LV426558	Breaker NSXm 70kA TM125D 3P busbar	C12H3TM125B	NSXm160H 70kAAC 3P 125A TMD BUSBAR	Yes	Yes
LV426559	Breaker NSXm 70kA TM160D 3P busbar	C12H3TM160B	NSXm160H 70kAAC 3P 160A TMD BUSBAR	Yes	Yes
LV426560	Breaker NSXm 70kA TM16D 4P/3T busbar	C11H6TM016B	NSXm100H 70kAAC 4P3D 16A TMD BUSBAR	Yes	Yes
LV426561	Breaker NSXm 70kA TM25D 4P/3T busbar	C11H6TM025B	NSXm100H 70kAAC 4P3D 25A TMD BUSBAR	Yes	Yes
LV426562	Breaker NSXm 70kA TM32D 4P/3T busbar	C11H6TM032B	NSXm100H 70kAAC 4P3D 32A TMD BUSBAR	Yes	Yes
LV426563	Breaker NSXm 70kA TM40D 4P/3T busbar	C11H6TM040B	NSXm100H 70kAAC 4P3D 40A TMD BUSBAR	Yes	Yes
LV426564	Breaker NSXm 70kA TM50D 4P/3T busbar	C11H6TM050B	NSXm100H 70kAAC 4P3D 50A TMD BUSBAR	Yes	Yes
LV426565	Breaker NSXm 70kA TM63D 4P/3T busbar	C11H6TM063B	NSXm100H 70kAAC 4P3D 63A TMD BUSBAR	Yes	Yes
LV426566	Breaker NSXm 70kA TM80D 4P/3T busbar	C11H6TM080B	NSXm100H 70kAAC 4P3D 80A TMD BUSBAR	Yes	Yes
LV426567	Breaker NSXm 70kA TM100D 4P/3T busbar	C11H6TM100B	NSXm100H 70kAAC 4P3D 100A TMD BUSBAR	Yes	Yes
LV426568	Breaker NSXm 70kA TM125D 4P/3T busbar	C12H6TM125B	NSXm160H 70kAAC 4P3D 125A TMD BUSBAR	Yes	Yes
LV426569	Breaker NSXm 70kA TM160D 4P/3T busbar	C12H6TM160B	NSXm160H 70kAAC 4P3D 160A TMD BUSBAR	Yes	Yes

Compatibility of Components of Existing and New ComPacT NSXm

Old ComPact NSXm		New ComPacT NSXm		Compatibility	
Cat. No	Description	Cat. No	Description	Old NSXm to New Retrofit NSXm	New Retrofit NSXm to old NSXm
LV426570	Breaker NSXm 70kA TM16D 4P/4T busbar	C11H4TM016B	NSXm100H 70kAAC 4P4D 16A TMD BUSBAR	Yes	Yes
LV426571	Breaker NSXm 70kA TM25D 4P/4T busbar	C11H4TM025B	NSXm100H 70kAAC 4P4D 25A TMD BUSBAR	Yes	Yes
LV426572	Breaker NSXm 70kA TM32D 4P/4T busbar	C11H4TM032B	NSXm100H 70kAAC 4P4D 32A TMD BUSBAR	Yes	Yes
LV426573	Breaker NSXm 70kA TM40D 4P/4T busbar	C11H4TM040B	NSXm100H 70kAAC 4P4D 40A TMD BUSBAR	Yes	Yes
LV426574	Breaker NSXm 70kA TM50D 4P/4T busbar	C11H4TM050B	NSXm100H 70kAAC 4P4D 50A TMD BUSBAR	Yes	Yes
LV426575	Breaker NSXm 70kA TM63D 4P/4T busbar	C11H4TM063B	NSXm100H 70kAAC 4P4D 63A TMD BUSBAR	Yes	Yes
LV426576	Breaker NSXm 70kA TM80D 4P/4T busbar	C11H4TM080B	NSXm100H 70kAAC 4P4D 80A TMD BUSBAR	Yes	Yes
LV426577	Breaker NSXm 70kA TM100D 4P/4T busbar	C11H4TM100B	NSXm100H 70kAAC 4P4D 100A TMD BUSBAR	Yes	Yes
LV426578	Breaker NSXm 70kA TM125D 4P/4T busbar	C12H4TM125B	NSXm160H 70kAAC 4P4D 125A TMD BUSBAR	Yes	Yes
LV426579	Breaker NSXm 70kA TM160D 4P/4T busbar	C12H4TM160B	NSXm160H 70kAAC 4P4D 160A TMD BUSBAR	Yes	Yes
LV426700	Breaker NSXm 16kA Vigi 25A 3P Elink	C11E34V025L	NSXm100E 16kAAC 3P 25A 4.1 ELINK	Yes	Yes
LV426701	Breaker NSXm 16kA Vigi 50A 3P Elink	C11E34V050L	NSXm100E 16kAAC 3P 50A 4.1 ELINK	Yes	Yes
LV426702	Breaker NSXm 16kA Vigi 100A 3P Elink	C11E34V100L	NSXm100E 16kAAC 3P 100A 4.1 ELINK	Yes	Yes
LV426703	Breaker NSXm 16kA Vigi 160A 3P Elink	C12E34V160L	NSXm160E 16kAAC 3P 160A 4.1 ELINK	Yes	Yes
LV426705	Breaker NSXm 16kA Vigi 25A 4P Elink	C11E44V025L	NSXm100E 16kAAC 4P 25A 4.1 ELINK	Yes	Yes
LV426706	Breaker NSXm 16kA Vigi 50A 4P Elink	C11E44V050L	NSXm100E 16kAAC 4P 50A 4.1 ELINK	Yes	Yes
LV426707	Breaker NSXm 16kA Vigi 100A 4P Elink	C11E44V100L	NSXm100E 16kAAC 4P 100A 4.1 ELINK	Yes	Yes
LV426708	Breaker NSXm 16kA Vigi 160A 4P Elink	C12E44V160L	NSXm160E 16kAAC 4P 160A 4.1 ELINK	Yes	Yes
LV426750	Breaker NSXm 16kA Vigi 25A 3P busbar	C11E34V025B	NSXm100E 16kAAC 3P 25A 4.1 BUSBAR	Yes	Yes
LV426751	Breaker NSXm 16kA Vigi 50A 3P busbar	C11E34V050B	NSXm100E 16kAAC 3P 50A 4.1 BUSBAR	Yes	Yes
LV426752	Breaker NSXm 16kA Vigi 100A 3P busbar	C11E34V100B	NSXm100E 16kAAC 3P 100A 4.1 BUSBAR	Yes	Yes
LV426753	Breaker NSXm 16kA Vigi 160A 3P busbar	C12E34V160B	NSXm160E 16kAAC 3P 160A 4.1 BUSBAR	Yes	Yes
LV426755	Breaker NSXm 16kA Vigi 25A 4P busbar	C11E44V025B	NSXm100E 16kAAC 4P 25A 4.1 BUSBAR	Yes	Yes
LV426756	Breaker NSXm 16kA Vigi 50A 4P busbar	C11E44V050B	NSXm100E 16kAAC 4P 50A 4.1 BUSBAR	Yes	Yes
LV426757	Breaker NSXm 16kA Vigi 100A 4P busbar	C11E44V100B	NSXm100E 16kAAC 4P 100A 4.1 BUSBAR	Yes	Yes
LV426758	Breaker NSXm 16kA Vigi 160A 4P busbar	C12E44V160B	NSXm160E 16kAAC 4P 160A 4.1 BUSBAR	Yes	Yes
LV426710	Breaker NSXm 25kA Vigi 25A 3P Elink	C11B34V025L	NSXm100B 25kAAC 3P 25A 4.1 ELINK	Yes	Yes
LV426711	Breaker NSXm 25kA Vigi 50A 3P Elink	C11B34V050L	NSXm100B 25kAAC 3P 50A 4.1 ELINK	Yes	Yes
LV426712	Breaker NSXm 25kA Vigi 100A 3P Elink	C11B34V100L	NSXm100B 25kAAC 3P 100A 4.1 ELINK	Yes	Yes
LV426713	Breaker NSXm 25kA Vigi 160A 3P Elink	C12B34V160L	NSXm160B 25kAAC 3P 160A 4.1 ELINK	Yes	Yes
LV426715	Breaker NSXm 25kA Vigi 25A 4P Elink	C11B44V025L	NSXm100B 25kAAC 4P 25A 4.1 ELINK	Yes	Yes
LV426716	Breaker NSXm 25kA Vigi 50A 4P Elink	C11B44V050L	NSXm100B 25kAAC 4P 50A 4.1 ELINK	Yes	Yes
LV426717	Breaker NSXm 25kA Vigi 100A 4P Elink	C11B44V100L	NSXm100B 25kAAC 4P 100A 4.1 ELINK	Yes	Yes
LV426718	Breaker NSXm 25kA Vigi 160A 4P Elink	C12B44V160L	NSXm160B 25kAAC 4P 160A 4.1 ELINK	Yes	Yes
LV426760	Breaker NSXm 25kA Vigi 25A 3P busbar	C11B34V025B	NSXm100B 25kAAC 3P 25A 4.1 BUSBAR	Yes	Yes
LV426761	Breaker NSXm 25kA Vigi 50A 3P busbar	C11B34V050B	NSXm100B 25kAAC 3P 50A 4.1 BUSBAR	Yes	Yes
LV426762	Breaker NSXm 25kA Vigi 100A 3P busbar	C11B34V100B	NSXm100B 25kAAC 3P 100A 4.1 BUSBAR	Yes	Yes
LV426763	Breaker NSXm 25kA Vigi 160A 3P busbar	C12B34V160B	NSXm160B 25kAAC 3P 160A 4.1 BUSBAR	Yes	Yes
LV426765	Breaker NSXm 25kA Vigi 25A 4P busbar	C11B44V025B	NSXm100B 25kAAC 4P 25A 4.1 BUSBAR	Yes	Yes
LV426766	Breaker NSXm 25kA Vigi 50A 4P busbar	C11B44V050B	NSXm100B 25kAAC 4P 50A 4.1 BUSBAR	Yes	Yes
LV426767	Breaker NSXm 25kA Vigi 100A 4P busbar	C11B44V100B	NSXm100B 25kAAC 4P 100A 4.1 BUSBAR	Yes	Yes
LV426768	Breaker NSXm 25kA Vigi 160A 4P busbar	C12B44V160B	NSXm160B 25kAAC 4P 160A 4.1 BUSBAR	Yes	Yes
LV426720	Breaker NSXm 36kA Vigi 25A 3P Elink	C11F34V025L	NSXm100F 36kAAC 3P 25A 4.1 ELINK	Yes	Yes
LV426721	Breaker NSXm 36kA Vigi 50A 3P Elink	C11F34V050L	NSXm100F 36kAAC 3P 50A 4.1 ELINK	Yes	Yes
LV426722	Breaker NSXm 36kA Vigi 100A 3P Elink	C11F34V100L	NSXm100F 36kAAC 3P 100A 4.1 ELINK	Yes	Yes
LV426723	Breaker NSXm 36kA Vigi 160A 3P Elink	C12F34V160L	NSXm160F 36kAAC 3P 160A 4.1 ELINK	Yes	Yes
LV426725	Breaker NSXm 36kA Vigi 25A 4P Elink	C11F44V025L	NSXm100F 36kAAC 4P 25A 4.1 ELINK	Yes	Yes
LV426726	Breaker NSXm 36kA Vigi 50A 4P Elink	C11F44V050L	NSXm100F 36kAAC 4P 50A 4.1 ELINK	Yes	Yes
LV426727	Breaker NSXm 36kA Vigi 100A 4P Elink	C11F44V100L	NSXm100F 36kAAC 4P 100A 4.1 ELINK	Yes	Yes
LV426728	Breaker NSXm 36kA Vigi 160A 4P Elink	C12F44V160L	NSXm160F 36kAAC 4P 160A 4.1 ELINK	Yes	Yes
LV426770	Breaker NSXm 36kA Vigi 25A 3P busbar	C11F34V025B	NSXm100F 36kAAC 3P 25A 4.1 BUSBAR	Yes	Yes
LV426771	Breaker NSXm 36kA Vigi 50A 3P busbar	C11F34V050B	NSXm100F 36kAAC 3P 50A 4.1 BUSBAR	Yes	Yes
LV426772	Breaker NSXm 36kA Vigi 100A 3P busbar	C11F34V100B	NSXm100F 36kAAC 3P 100A 4.1 BUSBAR	Yes	Yes
LV426773	Breaker NSXm 36kA Vigi 160A 3P busbar	C12F34V160B	NSXm160F 36kAAC 3P 160A 4.1 BUSBAR	Yes	Yes
LV426775	Breaker NSXm 36kA Vigi 25A 4P busbar	C11F44V025B	NSXm100F 36kAAC 4P 25A 4.1 BUSBAR	Yes	Yes
LV426776	Breaker NSXm 36kA Vigi 50A 4P busbar	C11F44V050B	NSXm100F 36kAAC 4P 50A 4.1 BUSBAR	Yes	Yes
LV426777	Breaker NSXm 36kA Vigi 100A 4P busbar	C11F44V100B	NSXm100F 36kAAC 4P 100A 4.1 BUSBAR	Yes	Yes
LV426778	Breaker NSXm 36kA Vigi 160A 4P busbar	C12F44V160B	NSXm160F 36kAAC 4P 160A 4.1 BUSBAR	Yes	Yes

Compatibility of Components of Existing and New ComPacT NSXm

Old ComPact NSXm		New ComPacT NSXm		Compatibility	
Cat. No	Description	Cat. No	Description	Old NSXm to New Retrofit NSXm	New Retrofit NSXm to old NSXm
LV426730	Breaker NSXm 50kA Vigi 25A 3P Elink	C11N34V025L	NSXm100N 50kAAC 3P 25A 4.1 ELINK	Yes	Yes
LV426731	Breaker NSXm 50kA Vigi 50A 3P Elink	C11N34V050L	NSXm100N 50kAAC 3P 50A 4.1 ELINK	Yes	Yes
LV426732	Breaker NSXm 50kA Vigi 100A 3P Elink	C11N34V100L	NSXm100N 50kAAC 3P 100A 4.1 ELINK	Yes	Yes
LV426733	Breaker NSXm 50kA Vigi 160A 3P Elink	C12N34V160L	NSXm160N 50kAAC 3P 160A 4.1 ELINK	Yes	Yes
LV426735	Breaker NSXm 50kA Vigi 25A 4P Elink	C11N44V025L	NSXm100N 50kAAC 4P 25A 4.1 ELINK	Yes	Yes
LV426736	Breaker NSXm 50kA Vigi 50A 4P Elink	C11N44V050L	NSXm100N 50kAAC 4P 50A 4.1 ELINK	Yes	Yes
LV426737	Breaker NSXm 50kA Vigi 100A 4P Elink	C11N44V100L	NSXm100N 50kAAC 4P 100A 4.1 ELINK	Yes	Yes
LV426738	Breaker NSXm 50kA Vigi 160A 4P Elink	C12N44V160L	NSXm160N 50kAAC 4P 160A 4.1 ELINK	Yes	Yes
LV426780	Breaker NSXm 50kA Vigi 25A 3P busbar	C11N34V025B	NSXm100N 50kAAC 3P 25A 4.1 BUSBAR	Yes	Yes
LV426781	Breaker NSXm 50kA Vigi 50A 3P busbar	C11N34V050B	NSXm100N 50kAAC 3P 50A 4.1 BUSBAR	Yes	Yes
LV426782	Breaker NSXm 50kA Vigi 100A 3P busbar	C11N34V100B	NSXm100N 50kAAC 3P 100A 4.1 BUSBAR	Yes	Yes
LV426783	Breaker NSXm 50kA Vigi 160A 3P busbar	C12N34V160B	NSXm160N 50kAAC 3P 160A 4.1 BUSBAR	Yes	Yes
LV426785	Breaker NSXm 50kA Vigi 25A 4P busbar	C11N44V025B	NSXm100N 50kAAC 4P 25A 4.1 BUSBAR	Yes	Yes
LV426786	Breaker NSXm 50kA Vigi 50A 4P busbar	C11N44V050B	NSXm100N 50kAAC 4P 50A 4.1 BUSBAR	Yes	Yes
LV426787	Breaker NSXm 50kA Vigi 100A 4P busbar	C11N44V100B	NSXm100N 50kAAC 4P 100A 4.1 BUSBAR	Yes	Yes
LV426788	Breaker NSXm 50kA Vigi 160A 4P busbar	C12N44V160B	NSXm160N 50kAAC 4P 160A 4.1 BUSBAR	Yes	Yes
LV426740	Breaker NSXm 70kA Vigi 25A 3P Elink	C11H34V025L	NSXm100H 70kAAC 3P 25A 4.1 ELINK	Yes	Yes
LV426741	Breaker NSXm 70kA Vigi 50A 3P Elink	C11H34V050L	NSXm100H 70kAAC 3P 50A 4.1 ELINK	Yes	Yes
LV426742	Breaker NSXm 70kA Vigi 100A 3P Elink	C11H34V100L	NSXm100H 70kAAC 3P 100A 4.1 ELINK	Yes	Yes
LV426743	Breaker NSXm 70kA Vigi 160A 3P Elink	C12H34V160L	NSXm160H 70kAAC 3P 160A 4.1 ELINK	Yes	Yes
LV426745	Breaker NSXm 70kA Vigi 25A 4P Elink	C11H44V025L	NSXm100H 70kAAC 4P 25A 4.1 ELINK	Yes	Yes
LV426746	Breaker NSXm 70kA Vigi 50A 4P Elink	C11H44V050L	NSXm100H 70kAAC 4P 50A 4.1 ELINK	Yes	Yes
LV426747	Breaker NSXm 70kA Vigi 100A 4P Elink	C11H44V100L	NSXm100H 70kAAC 4P 100A 4.1 ELINK	Yes	Yes
LV426748	Breaker NSXm 70kA Vigi 160A 4P Elink	C12H44V160L	NSXm160H 70kAAC 4P 160A 4.1 ELINK	Yes	Yes
LV426790	Breaker NSXm 70kA Vigi 25A 3P busbar	C11H34V025B	NSXm100H 70kAAC 3P 25A 4.1 BUSBAR	Yes	Yes
LV426791	Breaker NSXm 70kA Vigi 50A 3P busbar	C11H34V050B	NSXm100H 70kAAC 3P 50A 4.1 BUSBAR	Yes	Yes
LV426792	Breaker NSXm 70kA Vigi 100A 3P busbar	C11H34V100B	NSXm100H 70kAAC 3P 100A 4.1 BUSBAR	Yes	Yes
LV426793	Breaker NSXm 70kA Vigi 160A 3P busbar	C12H34V160B	NSXm160H 70kAAC 3P 160A 4.1 BUSBAR	Yes	Yes
LV426795	Breaker NSXm 70kA Vigi 25A 4P busbar	C11H44V025B	NSXm100H 70kAAC 4P 25A 4.1 BUSBAR	Yes	Yes
LV426796	Breaker NSXm 70kA Vigi 50A 4P busbar	C11H44V050B	NSXm100H 70kAAC 4P 50A 4.1 BUSBAR	Yes	Yes
LV426797	Breaker NSXm 70kA Vigi 100A 4P busbar	C11H44V100B	NSXm100H 70kAAC 4P 100A 4.1 BUSBAR	Yes	Yes
LV426798	Breaker NSXm 70kA Vigi 160A 4P busbar	C12H44V160B	NSXm160H 70kAAC 4P 160A 4.1 BUSBAR	Yes	Yes
LV426600	Switch NSXm 50NNA 3P Elink disconnecting	C113050LS	SWITCH NSXm100NAAC 3P 50A ELINK	Yes	Yes
LV426601	Switch NSXm 100NA 3P Elink disconnecting	C113100LS	SWITCH NSXm100NAAC 3P 100A ELINK	Yes	Yes
LV426602	Switch NSXm 160NA 3P Elink disconnecting	C123160LS	SWITCH NSXm160NAAC 3P 160A ELINK	Yes	Yes
LV426610	Switch NSXm 50NA 4P Elink disconnecting	C114050LS	SWITCH NSXm100NAAC 4P 50A ELINK	Yes	Yes
LV426611	Switch NSXm 100NA 4P Elink disconnecting	C114100LS	SWITCH NSXm100NAAC 4P 100A ELINK	Yes	Yes
LV426612	Switch NSXm 160NA 4P Elink disconnecting	C124160LS	SWITCH NSXm160NAAC 4P 160A ELINK	Yes	Yes
LV426650	Switch NSXm 50NA 3P busbar disconnecting	C113050BS	SWITCH NSXm100NAAC 3P 50A BUSBAR	Yes	Yes
LV426651	Switch NSXm 100NA 3P busbar disconnecting	C113100BS	SWITCH NSXm100NAAC 3P 100A BUSBAR	Yes	Yes
LV426652	Switch NSXm 160NA 3P busbar disconnecting	C123160BS	SWITCH NSXm160NAAC 3P 160A BUSBAR	Yes	Yes
LV426660	Switch NSXm 50NA 4P busbar disconnecting	C114050BS	SWITCH NSXm100NAAC 4P 50A BUSBAR	Yes	Yes
LV426661	Switch NSXm 100NA 4P busbar disconnecting	C114100BS	SWITCH NSXm100NAAC 4P 100A BUSBAR	Yes	Yes
LV426662	Switch NSXm 160NA 4P busbar disconnecting	C124160BS	SWITCH NSXm160NAAC 4P 160A BUSBAR	Yes	Yes

Compatibility of Components of Existing and New ComPacT NSX100/160/250

Old ComPacT NSX		New ComPacT NSX		Compatibility	
Cat. No	Description	Cat. No	Description	Old NSX to New Retrofit NSX	New Retrofit NSX to old NSX
LV438562	BREAKER NSX100F 16A 1P 36KAAC/DC	C10F1TM016	NSX100F 18kAAC-DC 1P 16A TMD	Yes	Yes
LV438563	BREAKER NSX100F 20A 1P 36KAAC/DC	C10F1TM020	NSX100F 18kAAC-DC 1P 20A TMD	Yes	Yes
LV438564	BREAKER NSX100F 25A 1P 36KAAC/DC	C10F1TM025	NSX100F 18kAAC-DC 1P 25A TMD	Yes	Yes
LV438565	BREAKER NSX100F 30A 1P 36KAAC/DC	C10F1TM030	NSX100F 18kAAC-DC 1P 30A TMD	Yes	Yes
LV438566	BREAKER NSX100F 40A 1P 36KAAC/DC	C10F1TM040	NSX100F 18kAAC-DC 1P 40A TMD	Yes	Yes
LV438567	BREAKER NSX100F 50A 1P 36KAAC/DC	C10F1TM050	NSX100F 18kAAC-DC 1P 50A TMD	Yes	Yes
LV438568	BREAKER NSX100F 63A 1P 36KAAC/DC	C10F1TM063	NSX100F 18kAAC-DC 1P 63A TMD	Yes	Yes
LV438569	BREAKER NSX100F 80A 1P 36KAAC/DC	C10F1TM080	NSX100F 18kAAC-DC 1P 80A TMD	Yes	Yes
LV438570	BREAKER NSX100F 100A 1P 36KAAC/DC	C10F1TM100	NSX100F 18kAAC-DC 1P 100A TMD	Yes	Yes
LV438592	BREAKER NSX100F 16A 2P 36KAAC/DC	C10F2TM016	NSX100F 18kAAC-DC 2P 16A TMD	Yes	Yes
LV438593	BREAKER NSX100F 20A 2P 36KAAC/DC	C10F2TM020	NSX100F 18kAAC-DC 2P 20A TMD	Yes	Yes
LV438594	BREAKER NSX100F 25A 2P 36KAAC/DC	C10F2TM025	NSX100F 18kAAC-DC 2P 25A TMD	Yes	Yes
LV438595	BREAKER NSX100F 30A 2P 36KAAC/DC	C10F2TM030	NSX100F 18kAAC-DC 2P 30A TMD	Yes	Yes
LV438596	BREAKER NSX100F 40A 2P 36KAAC/DC	C10F2TM040	NSX100F 18kAAC-DC 2P 40A TMD	Yes	Yes
LV438597	BREAKER NSX100F 50A 2P 36KAAC/DC	C10F2TM050	NSX100F 18kAAC-DC 2P 50A TMD	Yes	Yes
LV438598	BREAKER NSX100F 63A 2P 36KAAC/DC	C10F2TM063	NSX100F 18kAAC-DC 2P 63A TMD	Yes	Yes
LV438599	BREAKER NSX100F 80A 2P 36KAAC/DC	C10F2TM080	NSX100F 18kAAC-DC 2P 80A TMD	Yes	Yes
LV438600	BREAKER NSX100F 100A 2P 36KAAC/DC	C10F2TM100	NSX100F 18kAAC-DC 2P 100A TMD	Yes	Yes
LV438669	BREAKER NSX160F 125A 1P 36KAAC/DC	C16F1TM125	NSX160F 18kAAC-DC 1P 125A TMD	Yes	Yes
LV438670	BREAKER NSX160F 160A 1P 36KAAC/DC	C16F1TM160	NSX160F 18kAAC-DC 1P 160A TMD	Yes	Yes
LV438699	BREAKER NSX160F 125A 2P 36KAAC/DC	C16F2TM125	NSX160F 18kAAC-DC 2P 125A TMD	Yes	Yes
LV438700	BREAKER NSX160F 160A 2P 36KAAC/DC	C16F2TM160	NSX160F 18kAAC-DC 2P 160A TMD	Yes	Yes
LV438572	BREAKER NSX100N 16A 1P 50KAAC/DC	C10N1TM016	NSX100N 25kAAC-DC 1P 16A TMD	Yes	Yes
LV438573	BREAKER NSX100N 20A 1P 50KAAC/DC	C10N1TM020	NSX100N 25kAAC-DC 1P 20A TMD	Yes	Yes
LV438574	BREAKER NSX100N 25A 1P 50KAAC/DC	C10N1TM025	NSX100N 25kAAC-DC 1P 25A TMD	Yes	Yes
LV438575	BREAKER NSX100N 30A 1P 50KAAC/DC	C10N1TM030	NSX100N 25kAAC-DC 1P 30A TMD	Yes	Yes
LV438576	BREAKER NSX100N 40A 1P 50KAAC/DC	C10N1TM040	NSX100N 25kAAC-DC 1P 40A TMD	Yes	Yes
LV438577	BREAKER NSX100N 50A 1P 50KAAC/DC	C10N1TM050	NSX100N 25kAAC-DC 1P 50A TMD	Yes	Yes
LV438578	BREAKER NSX100N 63A 1P 50KAAC/DC	C10N1TM063	NSX100N 25kAAC-DC 1P 63A TMD	Yes	Yes
LV438579	BREAKER NSX100N 80A 1P 50KAAC/DC	C10N1TM080	NSX100N 25kAAC-DC 1P 80A TMD	Yes	Yes
LV438580	BREAKER NSX100N 100A 1P 50KAAC/DC	C10N1TM100	NSX100N 25kAAC-DC 1P 100A TMD	Yes	Yes
LV438602	BREAKER NSX100M 16A 2P 85KAAC/DC	C10M2TM016	NSX100M 25kAAC-DC 2P 16A TMD	Yes	Yes
LV438603	BREAKER NSX100M 20A 2P 85KAAC/DC	C10M2TM020	NSX100M 25kAAC-DC 2P 20A TMD	Yes	Yes
LV438604	BREAKER NSX100M 25A 2P 85KAAC/DC	C10M2TM025	NSX100M 25kAAC-DC 2P 25A TMD	Yes	Yes
LV438605	BREAKER NSX100M 30A 2P 85KAAC/DC	C10M2TM030	NSX100M 25kAAC-DC 2P 30A TMD	Yes	Yes
LV438606	BREAKER NSX100M 40A 2P 85KAAC/DC	C10M2TM040	NSX100M 25kAAC-DC 2P 40A TMD	Yes	Yes
LV438607	BREAKER NSX100M 50A 2P 85KAAC/DC	C10M2TM050	NSX100M 25kAAC-DC 2P 50A TMD	Yes	Yes
LV438608	BREAKER NSX100M 63A 2P 85KAAC/DC	C10M2TM063	NSX100M 25kAAC-DC 2P 63A TMD	Yes	Yes
LV438609	BREAKER NSX100M 80A 2P 85KAAC/DC	C10M2TM080	NSX100M 25kAAC-DC 2P 80A TMD	Yes	Yes
LV438610	BREAKER NSX100M 100A 2P 85KAAC/DC	C10M2TM100	NSX100M 25kAAC-DC 2P 100A TMD	Yes	Yes
LV438679	BREAKER NSX160N 125A 1P 50KAAC/DC	C16N1TM125	NSX160N 25kAAC-DC 1P 125A TMD	Yes	Yes
LV438680	BREAKER NSX160N 160A 1P 50KAAC/DC	C16N1TM160	NSX160N 25kAAC-DC 1P 160A TMD	Yes	Yes
LV438709	BREAKER NSX160M 125A 2P 85KAAC/DC	C16M2TM125	NSX160M 40kAAC-DC 2P 125A TMD	Yes	Yes
LV438710	BREAKER NSX160M 160A 2P 85KAAC/DC	C16M2TM160	NSX160M 40kAAC-DC 2P 160A TMD	Yes	Yes
LV438582	BREAKER NSX100M 16A 1P 85KAAC/DC	C10M1TM016	NSX100M 40kAAC-DC 1P 16A TMD	Yes	Yes
LV438583	BREAKER NSX100M 20A 1P 85KAAC/DC	C10M1TM020	NSX100M 40kAAC-DC 1P 20A TMD	Yes	Yes
LV438584	BREAKER NSX100M 25A 1P 85KAAC/DC	C10M1TM025	NSX100M 40kAAC-DC 1P 25A TMD	Yes	Yes
LV438585	BREAKER NSX100M 30A 1P 85KAAC/DC	C10M1TM030	NSX100M 40kAAC-DC 1P 30A TMD	Yes	Yes
LV438586	BREAKER NSX100M 40A 1P 85KAAC/DC	C10M1TM040	NSX100M 40kAAC-DC 1P 40A TMD	Yes	Yes
LV438587	BREAKER NSX100M 50A 1P 85KAAC/DC	C10M1TM050	NSX100M 40kAAC-DC 1P 50A TMD	Yes	Yes
LV438588	BREAKER NSX100M 63A 1P 85KAAC/DC	C10M1TM063	NSX100M 40kAAC-DC 1P 63A TMD	Yes	Yes
LV438589	BREAKER NSX100M 80A 1P 85KAAC/DC	C10M1TM080	NSX100M 40kAAC-DC 1P 80A TMD	Yes	Yes
LV438590	BREAKER NSX100M 100A 1P 85KAAC/DC	C10M1TM100	NSX100M 40kAAC-DC 1P 100A TMD	Yes	Yes
LV438612	BREAKER NSX100S 16A 2P 100KAAC/DC	C10S2TM016	NSX100S 70kAAC-DC 2P 16A TMD	Yes	Yes
LV438613	BREAKER NSX100S 20A 2P 100KAAC/DC	C10S2TM020	NSX100S 70kAAC-DC 2P 20A TMD	Yes	Yes
LV438614	BREAKER NSX100S 25A 2P 100KAAC/DC	C10S2TM025	NSX100S 70kAAC-DC 2P 25A TMD	Yes	Yes
LV438615	BREAKER NSX100S 30A 2P 100KAAC/DC	C10S2TM030	NSX100S 70kAAC-DC 2P 30A TMD	Yes	Yes
LV438616	BREAKER NSX100S 40A 2P 100KAAC/DC	C10S2TM040	NSX100S 70kAAC-DC 2P 40A TMD	Yes	Yes

Compatibility of Components of Existing and New ComPacT NSX100/160/250

Old ComPact NSX		New ComPacT NSX		Compatibility	
Cat. No	Description	Cat. No	Description	Old NSX to New Retrofit NSX	New Retrofit NSX to old NSX
LV438617	BREAKER NSX100S 50A 2P 100KAAC/DC	C10S2TM050	NSX100S 70kAAC-DC 2P 50A TMD	Yes	Yes
LV438618	BREAKER NSX100S 63A 2P 100KAAC/DC	C10S2TM063	NSX100S 70kAAC-DC 2P 63A TMD	Yes	Yes
LV438619	BREAKER NSX100S 80A 2P 100KAAC/DC	C10S2TM080	NSX100S 70kAAC-DC 2P 80A TMD	Yes	Yes
LV438620	BREAKER NSX100S 100A 2P 100KAAC/DC	C10S2TM100	NSX100S 70kAAC-DC 2P 100A TMD	Yes	Yes
LV438689	BREAKER NSX160M 125A 1P 85KAAC/DC	C16M1TM125	NSX160M 40kAAC-DC 1P 125A TMD	Yes	Yes
LV438690	BREAKER NSX160M 160A 1P 85KAAC/DC	C16M1TM160	NSX160M 40kAAC-DC 1P 160A TMD	Yes	Yes
LV438719	BREAKER NSX160S 125A 2P 100KAAC/DC	C16S2TM125	NSX160S 70kAAC-DC 2P 125A TMD	Yes	Yes
LV438720	BREAKER NSX160S 160A 2P 100KAAC/DC	C16S2TM160	NSX160S 70kAAC-DC 2P 160A TMD	Yes	Yes
LV438693	1P 1D TM160D NSX250N	C25N1TM160	NSX250N 25kAAC-DC 1P 160A TMD	Yes	Yes
LV438694	1P 1D TM200D NSX250N	C25N1TM200	NSX250N 25kAAC-DC 1P 200A TMD	Yes	Yes
LV438695	1P 1D TM250N NSX250B	C25N1TM250	NSX250N 25kAAC-DC 1P 250A TMD	Yes	Yes
LV429557	3P3T TM16D NSX100B	C10B3TM016	NSX100B 25kAAC 3P3D 16A TMD	Yes	Yes
LV429556	3P3T TM25D NSX100B	C10B3TM025	NSX100B 25kAAC 3P3D 25A TMD	Yes	Yes
LV429555	3P3T TM32T NSX100B	C10B3TM032	NSX100B 25kAAC 3P3D 32A TMD	Yes	Yes
LV429554	NSX100B TM40D 3P3T	C10B3TM040	NSX100B 25kAAC 3P3D 40A TMD	Yes	Yes
LV429553	3P3T TM50D NSX100B	C10B3TM050	NSX100B 25kAAC 3P3D 50A TMD	Yes	Yes
LV429552	NSX100B TM63D 3P3T	C10B3TM063	NSX100B 25kAAC 3P3D 63A TMD	Yes	Yes
LV429551	NSX100B TM80D 3P3T	C10B3TM080	NSX100B 25kAAC 3P3D 80A TMD	Yes	Yes
LV429550	NSX100B TM100D 3P3T	C10B3TM100	NSX100B 25kAAC 3P3D 100A TMD	Yes	Yes
LV430313	3P3T TM80D NSX160B	C16B3TM080	NSX160B 25kAAC 3P3D 80A TMD	Yes	Yes
LV430312	3P3T TM100D NSX160B	C16B3TM100	NSX160B 25kAAC 3P3D 100A TMD	Yes	Yes
LV430311	NSX160B TM125D 3P3T	C16B3TM125	NSX160B 25kAAC 3P3D 125A TMD	Yes	Yes
LV430310	NSX160B TM160D 3P3T	C16B3TM160	NSX160B 25kAAC 3P3D 160A TMD	Yes	Yes
LV431113	3P3T TM125D NSX250B	C25B3TM125	NSX250B 25kAAC 3P3D 125A TMD	Yes	Yes
LV431112	3P3T TM160D NSX250B	C25B3TM160	NSX250B 25kAAC 3P3D 160A TMD	Yes	Yes
LV431111	NSX250B TM200D 3P3T	C25B3TM200	NSX250B 25kAAC 3P3D 200A TMD	Yes	Yes
LV431110	NSX250B TM250D 3P3T	C25B3TM250	NSX250B 25kAAC 3P3D 250A TMD	Yes	Yes
LV429567	4P3T TM16D NSX100B	C10B6TM016	NSX100B 25kAAC 4P3D 16A TMD	Yes	Yes
LV429566	4P3T TM25D NSX100B	C10B6TM025	NSX100B 25kAAC 4P3D 25A TMD	Yes	Yes
LV429565	4P3T TM32T NSX100B	C10B6TM032	NSX100B 25kAAC 4P3D 32A TMD	Yes	Yes
LV429564	4P3T TM40D NSX100B	C10B6TM040	NSX100B 25kAAC 4P3D 40A TMD	Yes	Yes
LV429563	4P3T TM50D NSX100B	C10B6TM050	NSX100B 25kAAC 4P3D 50A TMD	Yes	Yes
LV429562	4P3T TM63T NSX100B	C10B6TM063	NSX100B 25kAAC 4P3D 63A TMD	Yes	Yes
LV429561	4P3T TM80D NSX100B	C10B6TM080	NSX100B 25kAAC 4P3D 80A TMD	Yes	Yes
LV429560	4P3T TM100D NSX100B	C10B6TM100	NSX100B 25kAAC 4P3D 100A TMD	Yes	Yes
LV430323	4P3T TM80D NSX160B	C16B6TM080	NSX160B 25kAAC 4P3D 80A TMD	Yes	Yes
LV430322	4P3T TM100D NSX160B	C16B6TM100	NSX160B 25kAAC 4P3D 100A TMD	Yes	Yes
LV430321	4P3T TM125D NSX160B	C16B6TM125	NSX160B 25kAAC 4P3D 125A TMD	Yes	Yes
LV430320	4P3T TM160D NSX160B	C16B6TM160	NSX160B 25kAAC 4P3D 160A TMD	Yes	Yes
LV431123	4P3T TM125D NSX250B	C25B6TM125	NSX250B 25kAAC 4P3D 125A TMD	Yes	Yes
LV431122	4P3T TM160D NSX250B	C25B6TM160	NSX250B 25kAAC 4P3D 160A TMD	Yes	Yes
LV431121	4P3T TM200D NSX250B	C25B6TM200	NSX250B 25kAAC 4P3D 200A TMD	Yes	Yes
LV431120	4P3T TM250D NSX250B	C25B6TM250	NSX250B 25kAAC 4P3D 250A TMD	Yes	Yes
LV429577	4P4T TM16D NSX100B	C10B4TM016	NSX100B 25kAAC 4P4D 16A TMD	Yes	Yes
LV429576	4P4T TM25D NSX100B	C10B4TM025	NSX100B 25kAAC 4P4D 25A TMD	Yes	Yes
LV429575	4P4T TM32T NSX100B	C10B4TM032	NSX100B 25kAAC 4P4D 32A TMD	Yes	Yes
LV429574	4P4T TM40D NSX100B	C10B4TM040	NSX100B 25kAAC 4P4D 40A TMD	Yes	Yes
LV429573	4P4T TM50D NSX100B	C10B4TM050	NSX100B 25kAAC 4P4D 50A TMD	Yes	Yes
LV429572	4P4T TM63T NSX100B	C10B4TM063	NSX100B 25kAAC 4P4D 63A TMD	Yes	Yes
LV429571	4P4T TM80D NSX100B	C10B4TM080	NSX100B 25kAAC 4P4D 80A TMD	Yes	Yes
LV429570	4P4T TM100D NSX100B	C10B4TM100	NSX100B 25kAAC 4P4D 100A TMD	Yes	Yes
LV430333	4P4T TM80D NSX160B	C16B4TM080	NSX160B 25kAAC 4P4D 80A TMD	Yes	Yes
LV430332	4P4T TM100D NSX160B	C16B4TM100	NSX160B 25kAAC 4P4D 100A TMD	Yes	Yes
LV430331	4P4T TM125D NSX160B	C16B4TM125	NSX160B 25kAAC 4P4D 125A TMD	Yes	Yes
LV430330	4P4T TM160D NSX160B	C16B4TM160	NSX160B 25kAAC 4P4D 160A TMD	Yes	Yes
LV431133	4P4T TM125D NSX250B	C25B4TM125	NSX250B 25kAAC 4P4D 125A TMD	Yes	Yes
LV431132	4P4T TM160D NSX250B	C25B4TM160	NSX250B 25kAAC 4P4D 160A TMD	Yes	Yes
LV431131	4P4T TM200D NSX250B	C25B4TM200	NSX250B 25kAAC 4P4D 200A TMD	Yes	Yes

Compatibility of Components of Existing and New ComPacT NSX100/160/250

Old ComPacT NSX		New ComPacT NSX		Compatibility	
Cat. No	Description	Cat. No	Description	Old NSX to New Retrofit NSX	New Retrofit NSX to old NSX
LV431130	4P4T TM250D NSX250B	C25B4TM250	NSX250B 25kAAC 4P4D 250A TMD	Yes	Yes
LV429777	3P3T MICROLOGIC 2.2 40A NSX100B	C10B32D040	NSX100B 25kAAC 3P 40A 2.2	Yes	Yes
LV429775	3P3T MICROLOGIC 2.2 100A NSX100B	C10B32D100	NSX100B 25kAAC 3P 100A 2.2	Yes	Yes
LV430746	3P3T MICROLOGIC 2.2 100A NSX160B	C16B32D100	NSX160B 25kAAC 3P 100A 2.2	Yes	Yes
LV430745	3P3T MICROLOGIC 2.2 160A NSX160B	C16B32D160	NSX160B 25kAAC 3P 160A 2.2	Yes	Yes
LV431142	3P3T MICROLOGIC 2.2 100A NSX250B	C25B32D100	NSX250B 25kAAC 3P 100A 2.2	Yes	Yes
LV431141	3P3T MICROLOGIC 2.2 160A NSX250B	C25B32D160	NSX250B 25kAAC 3P 160A 2.2	Yes	Yes
LV431140	3P3T MICROLOGIC 2.2 250A NSX250B	C25B32D250	NSX250B 25kAAC 3P 250A 2.2	Yes	Yes
LV429787	4P4T MICROLOGIC 2.2 40A NSX100B	C10B42D040	NSX100B 25kAAC 4P 40A 2.2	Yes	Yes
LV429785	4P4T MICROLOGIC 2.2 100A NSX100B	C10B42D100	NSX100B 25kAAC 4P 100A 2.2	Yes	Yes
LV430751	4P4T MICROLOGIC 2.2 100A NSX160B	C16B42D100	NSX160B 25kAAC 4P 100A 2.2	Yes	Yes
LV430750	4P4T MICROLOGIC 2.2 160A NSX160B	C16B42D160	NSX160B 25kAAC 4P 160A 2.2	Yes	Yes
LV431152	4P4T MICROLOGIC 2.2 100A NSX250B	C25B42D100	NSX250B 25kAAC 4P 100A 2.2	Yes	Yes
LV431151	4P4T MICROLOGIC 2.2 160A NSX250B	C25B42D160	NSX250B 25kAAC 4P 160A 2.2	Yes	Yes
LV431150	4P4T MICROLOGIC 2.2 250A NSX250B	C25B42D250	NSX250B 25kAAC 4P 250A 2.2	Yes	Yes
LV429985	4P4T MICROLOGIC 2.2 40A VIGI MH NSX100B	C10B62D040	NSX100B 25kAAC 4P3D 40A 2.2	Yes	Yes
LV429984	4P4T MICROLOGIC 2.2 100A VIGI MH NSX100B	C10B62D100	NSX100B 25kAAC 4P3D 100A 2.2	Yes	Yes
LV430997	4P4T MICROLOGIC 2.2 40A VIGI MH NSX160B	C16B62D040	NSX160B 25kAAC 4P3D 40A 2.2	Yes	Yes
LV430996	4P4T MICROLOGIC 2.2 100A VIGI MH NSX160B	C16B62D100	NSX160B 25kAAC 4P3D 100A 2.2	Yes	Yes
LV430995	4P4T MICROLOGIC 2.2 160A VIGI MH NSX160B	C16B62D160	NSX160B 25kAAC 4P3D 160A 2.2	Yes	Yes
LV431987	4P4T MICROLOGIC 2.2 100A VIGI MH NSX250B	C25B62D100	NSX250B 25kAAC 4P3D 100A 2.2	Yes	Yes
LV431986	4P4T MICROLOGIC 2.2 160A VIGI MH NSX250B	C25B62D160	NSX250B 25kAAC 4P3D 160A 2.2	Yes	Yes
LV431985	4P4T MICROLOGIC 2.2 250A VIGI MH NSX250B	C25B62D250	NSX250B 25kAAC 4P3D 250A 2.2	Yes	Yes
LV429637	3P3T TM16D NSX100F	C10F3TM016	NSX100F 36kAAC 3P3D 16A TMD	Yes	Yes
LV429636	NSX100F TM25D 3P3T	C10F3TM025	NSX100F 36kAAC 3P3D 25A TMD	Yes	Yes
LV429635	NSX100F TM32D 3P3T	C10F3TM032	NSX100F 36kAAC 3P3D 32A TMD	Yes	Yes
LV429634	NSX100F TM40D 3P3T	C10F3TM040	NSX100F 36kAAC 3P3D 40A TMD	Yes	Yes
LV429633	NSX100F TM50D 3P3T	C10F3TM050	NSX100F 36kAAC 3P3D 50A TMD	Yes	Yes
LV429632	NSX100F TM63D 3P3T	C10F3TM063	NSX100F 36kAAC 3P3D 63A TMD	Yes	Yes
LV429631	NSX100F TM80D 3P3T	C10F3TM080	NSX100F 36kAAC 3P3D 80A TMD	Yes	Yes
LV429630	NSX100F TM100D 3P3T	C10F3TM100	NSX100F 36kAAC 3P3D 100A TMD	Yes	Yes
LV430633	3P3T TM80D NSX160F	C16F3TM080	NSX160F 36kAAC 3P3D 80A TMD	Yes	Yes
LV430632	3P3T TM100D NSX160F	C16F3TM100	NSX160F 36kAAC 3P3D 100A TMD	Yes	Yes
LV430631	NSX160F TM125D 3P3T	C16F3TM125	NSX160F 36kAAC 3P3D 125A TMD	Yes	Yes
LV430630	NSX160F TM160D 3P3T	C16F3TM160	NSX160F 36kAAC 3P3D 160A TMD	Yes	Yes
LV431633	3P3T TM125D NSX250F	C25F3TM125	NSX250F 36kAAC 3P3D 125A TMD	Yes	Yes
LV431632	3P3T TM160D NSX250F	C25F3TM160	NSX250F 36kAAC 3P3D 160A TMD	Yes	Yes
LV431631	NSX250F TM200D 3P3T	C25F3TM200	NSX250F 36kAAC 3P3D 200A TMD	Yes	Yes
LV431630	NSX250F TM250D 3P3T	C25F3TM250	NSX250F 36kAAC 3P3D 250A TMD	Yes	Yes
LV429772	3P3T MICROLOGIC 2.2 40A NSX100F	C10F32D040	NSX100F 36kAAC 3P3D 40A 2.2	Yes	Yes
LV429770	3P3T MICROLOGIC 2.2 100A NSX100F	C10F32D100	NSX100F 36kAAC 3P3D 100A 2.2	Yes	Yes
LV430771	3P3T MICROLOGIC 2.2 100A NSX160F	C16F32D100	NSX160F 36kAAC 3P3D 100A 2.2	Yes	Yes
LV430770	3P3T MICROLOGIC 2.2 160A NSX160F	C16F32D160	NSX160F 36kAAC 3P3D 160A 2.2	Yes	Yes
LV431772	3P3T MICROLOGIC 2.2 100A NSX250F	C25F32D100	NSX250F 36kAAC 3P3D 100A 2.2	Yes	Yes
LV431771	3P3T MICROLOGIC 2.2 160A NSX250F	C25F32D160	NSX250F 36kAAC 3P3D 160A 2.2	Yes	Yes
LV431770	3P3T MICROLOGIC 2.2 250A NSX250F	C25F32D250	NSX250F 36kAAC 3P3D 250A 2.2	Yes	Yes
LV429647	4P3T TM16D NSX100F	C10F6TM016	NSX100F 36kAAC 4P3D 16A TMD	Yes	Yes
LV429646	4P3T TM25D NSX100F	C10F6TM025	NSX100F 36kAAC 4P3D 25A TMD	Yes	Yes
LV429645	4P3T TM32D NSX100F	C10F6TM032	NSX100F 36kAAC 4P3D 32A TMD	Yes	Yes
LV429644	4P3T TM40D NSX100F	C10F6TM040	NSX100F 36kAAC 4P3D 40A TMD	Yes	Yes
LV429643	4P3T TM50D NSX100F	C10F6TM050	NSX100F 36kAAC 4P3D 50A TMD	Yes	Yes
LV429642	4P3T TM63D NSX100F	C10F6TM063	NSX100F 36kAAC 4P3D 63A TMD	Yes	Yes
LV429641	4P3T TM80D NSX100F	C10F6TM080	NSX100F 36kAAC 4P3D 80A TMD	Yes	Yes
LV429640	4P3T TM100D NSX100F	C10F6TM100	NSX100F 36kAAC 4P3D 100A TMD	Yes	Yes
LV430643	4P3T TM80D NSX160F	C16F6TM080	NSX160F 36kAAC 4P3D 80A TMD	Yes	Yes
LV430642	4P3T TM100D NSX160F	C16F6TM100	NSX160F 36kAAC 4P3D 100A TMD	Yes	Yes
LV430641	4P3T TM125D NSX160F	C16F6TM125	NSX160F 36kAAC 4P3D 125A TMD	Yes	Yes
LV430640	4P3T TM160D NSX160F	C16F6TM160	NSX160F 36kAAC 4P3D 160A TMD	Yes	Yes

Compatibility of Components of Existing and New ComPacT NSX100/160/250

Old ComPact NSX		New ComPact NSX		Compatibility	
Cat. No	Description	Cat. No	Description	Old NSX to New Retrofit NSX	New Retrofit NSX to old NSX
LV431643	4P3T TM125D NSX250F	C25F6TM125	NSX250F 36kAAC 4P3D 125A TMD	Yes	Yes
LV431642	4P3T TM160D NSX250F	C25F6TM160	NSX250F 36kAAC 4P3D 160A TMD	Yes	Yes
LV431641	4P3T TM200D NSX250F	C25F6TM200	NSX250F 36kAAC 4P3D 200A TMD	Yes	Yes
LV431640	4P3T TM250D NSX250F	C25F6TM250	NSX250F 36kAAC 4P3D 250A TMD	Yes	Yes
LV429782	4P4T MICROLOGIC 2.2 40A NSX100F	C10F42D040	NSX100F 36kAAC 4P4D 40A 2.2	Yes	Yes
LV429780	4P4T MICROLOGIC 2.2 100A NSX100F	C10F42D100	NSX100F 36kAAC 4P4D 100A 2.2	Yes	Yes
LV430781	4P4T MICROLOGIC 2.2 100A NSX160F	C16F42D100	NSX160F 36kAAC 4P4D 100A 2.2	Yes	Yes
LV430780	4P4T MICROLOGIC 2.2 160A NSX160F	C16F42D160	NSX160F 36kAAC 4P4D 160A 2.2	Yes	Yes
LV431782	4P4T MICROLOGIC 2.2 100A NSX250F	C25F42D100	NSX250F 36kAAC 4P4D 100A 2.2	Yes	Yes
LV431781	4P4T MICROLOGIC 2.2 160A NSX250F	C25F42D160	NSX250F 36kAAC 4P4D 160A 2.2	Yes	Yes
LV431780	4P4T MICROLOGIC 2.2 250A NSX250F	C25F42D250	NSX250F 36kAAC 4P4D 250A 2.2	Yes	Yes
LV429657	4P4T TM16D NSX100F	C10F4TM016	NSX100F 36kAAC 4P4D 16A TMD	Yes	Yes
LV429656	4P4T TM25D NSX100F	C10F4TM025	NSX100F 36kAAC 4P4D 25A TMD	Yes	Yes
LV429655	4P4T TM32D NSX100F	C10F4TM032	NSX100F 36kAAC 4P4D 32A TMD	Yes	Yes
LV429654	4P4T TM40D NSX100F	C10F4TM040	NSX100F 36kAAC 4P4D 40A TMD	Yes	Yes
LV429653	4P4T TM50D NSX100F	C10F4TM050	NSX100F 36kAAC 4P4D 50A TMD	Yes	Yes
LV429652	4P4T TM63D NSX100F	C10F4TM063	NSX100F 36kAAC 4P4D 63A TMD	Yes	Yes
LV429651	4P4T TM80D NSX100F	C10F4TM080	NSX100F 36kAAC 4P4D 80A TMD	Yes	Yes
LV429650	4P4T TM100D NSX100F	C10F4TM100	NSX100F 36kAAC 4P4D 100A TMD	Yes	Yes
LV430653	4P4T TM80D NSX160F	C16F4TM080	NSX160F 36kAAC 4P4D 80A TMD	Yes	Yes
LV430652	4P4T TM100D NSX160F	C16F4TM100	NSX160F 36kAAC 4P4D 100A TMD	Yes	Yes
LV430651	4P4T TM125D NSX160F	C16F4TM125	NSX160F 36kAAC 4P4D 125A TMD	Yes	Yes
LV430650	4P4T TM160D NSX160F	C16F4TM160	NSX160F 36kAAC 4P4D 160A TMD	Yes	Yes
LV431653	4P4T TM125D NSX250F	C25F4TM125	NSX250F 36kAAC 4P4D 125A TMD	Yes	Yes
LV431652	4P4T TM160D NSX250F	C25F4TM160	NSX250F 36kAAC 4P4D 160A TMD	Yes	Yes
LV431651	4P4T TM200D NSX250F	C25F4TM200	NSX250F 36kAAC 4P4D 200A TMD	Yes	Yes
LV431650	4P4T TM250D NSX250F	C25F4TM250	NSX250F 36kAAC 4P4D 250A TMD	Yes	Yes
LV429745	3P3T MA2.5 NSX100F	C10F3MA003	NSX100F 36kAAC 3P3D 2.5A MA	Yes	Yes
LV429744	3P3T MA6.3 NSX100F	C10F3MA007	NSX100F 36kAAC 3P3D 6.3A MA	Yes	Yes
LV429743	3P3T MA12.5 NSX100F	C10F3MA013	NSX100F 36kAAC 3P3D 12.5A MA	Yes	Yes
LV429742	3P3T MA25 NSX100F	C10F3MA025	NSX100F 36kAAC 3P3D 25A MA	Yes	Yes
LV429741	3P3T MA50 NSX100F	C10F3MA050	NSX100F 36kAAC 3P3D 50A MA	Yes	Yes
LV429740	3P3T MA100 NSX100F	C10F3MA100	NSX100F 36kAAC 3P3D 100A MA	Yes	Yes
LV430831	3P3T MA100 NSX160F	C16F3MA100	NSX160F 36kAAC 3P3D 100A MA	Yes	Yes
LV430830	3P3T MA150 NSX160F	C16F3MA150	NSX160F 36kAAC 3P3D 150A MA	Yes	Yes
LV431749	3P3T MA150 NSX250F	C25F3MA150	NSX250F 36kAAC 3P3D 150A MA	Yes	Yes
LV431748	3P3T MA220 NSX250F	C25F3MA220	NSX250F 36kAAC 3P3D 220A MA	Yes	Yes
LV429847	3P3T TM16D NSX100N	C10N3TM016	NSX100N 50kAAC 3P3D 16A TMD	Yes	Yes
LV429846	3P3T TM25D NSX100N	C10N3TM025	NSX100N 50kAAC 3P3D 25A TMD	Yes	Yes
LV429845	3P3T TM32D NSX100N	C10N3TM032	NSX100N 50kAAC 3P3D 32A TMD	Yes	Yes
LV429844	3P3T TM40D NSX100N	C10N3TM040	NSX100N 50kAAC 3P3D 40A TMD	Yes	Yes
LV429843	3P3T TM50D NSX100N	C10N3TM050	NSX100N 50kAAC 3P3D 50A TMD	Yes	Yes
LV429842	3P3T TM63D NSX100N	C10N3TM063	NSX100N 50kAAC 3P3D 63A TMD	Yes	Yes
LV429841	3P3T TM80D NSX100N	C10N3TM080	NSX100N 50kAAC 3P3D 80A TMD	Yes	Yes
LV429840	3P3T TM100D NSX100N	C10N3TM100	NSX100N 50kAAC 3P3D 100A TMD	Yes	Yes
LV430843	3P3T TM80D NSX160N	C16N3TM080	NSX160N 50kAAC 3P3D 80A TMD	Yes	Yes
LV430842	3P3T TM100D NSX160N	C16N3TM100	NSX160N 50kAAC 3P3D 100A TMD	Yes	Yes
LV430841	3P3T TM125D NSX160N	C16N3TM125	NSX160N 50kAAC 3P3D 125A TMD	Yes	Yes
LV430840	3P3T TM160D NSX160N	C16N3TM160	NSX160N 50kAAC 3P3D 160A TMD	Yes	Yes
LV431833	3P3T TM125D NSX250N	C25N3TM125	NSX250N 50kAAC 3P3D 125A TMD	Yes	Yes
LV431832	3P3T TM160D NSX250N	C25N3TM160	NSX250N 50kAAC 3P3D 160A TMD	Yes	Yes
LV431831	3P3T TM200D NSX250N	C25N3TM200	NSX250N 50kAAC 3P3D 200A TMD	Yes	Yes
LV431830	3P3T TM250D NSX250N	C25N3TM250	NSX250N 50kAAC 3P3D 250A TMD	Yes	Yes
LV429857	4P3T TM16D NSX100N	C10N6TM016	NSX100N 50kAAC 4P3D 16A TMD	Yes	Yes
LV429856	4P3T TM25D NSX100N	C10N6TM025	NSX100N 50kAAC 4P3D 25A TMD	Yes	Yes
LV429855	4P3T TM32D NSX100N	C10N6TM032	NSX100N 50kAAC 4P3D 32A TMD	Yes	Yes
LV429854	4P3T TM40D NSX100N	C10N6TM040	NSX100N 50kAAC 4P3D 40A TMD	Yes	Yes
LV429853	4P3T TM50D NSX100N	C10N6TM050	NSX100N 50kAAC 4P3D 50A TMD	Yes	Yes

Compatibility of Components of Existing and New ComPacT NSX100/160/250

Old ComPact NSX		New ComPact NSX		Compatibility	
Cat. No	Description	Cat. No	Description	Old NSX to New Retrofit NSX	New Retrofit NSX to old NSX
LV429852	4P3T TM63D NSX100N	C10N6TM063	NSX100N 50kAAC 4P3D 63A TMD	Yes	Yes
LV429851	4P3T TM80D NSX100N	C10N6TM080	NSX100N 50kAAC 4P3D 80A TMD	Yes	Yes
LV429850	4P3T TM100D NSX100N	C10N6TM100	NSX100N 50kAAC 4P3D 100A TMD	Yes	Yes
LV430853	4P3T TM80D NSX160N	C16N6TM080	NSX160N 50kAAC 4P3D 80A TMD	Yes	Yes
LV430852	4P3T TM100D NSX160N	C16N6TM100	NSX160N 50kAAC 4P3D 100A TMD	Yes	Yes
LV430851	4P3T TM125D NSX160N	C16N6TM125	NSX160N 50kAAC 4P3D 125A TMD	Yes	Yes
LV430850	4P3T TM160D NSX160N	C16N6TM160	NSX160N 50kAAC 4P3D 160A TMD	Yes	Yes
LV431843	4P3T TM125D NSX250N	C25N6TM125	NSX250N 50kAAC 4P3D 125A TMD	Yes	Yes
LV431842	4P3T TM160D NSX250N	C25N6TM160	NSX250N 50kAAC 4P3D 160A TMD	Yes	Yes
LV431841	4P3T TM200D NSX250N	C25N6TM200	NSX250N 50kAAC 4P3D 200A TMD	Yes	Yes
LV431840	4P3T TM250D NSX250N	C25N6TM250	NSX250N 50kAAC 4P3D 250A TMD	Yes	Yes
LV429797	3P3T MICROLOGIC 2.2 40A NSX100N	C10N32D040	NSX100N 50kAAC 3P3D 40A 2.2	Yes	Yes
LV429795	3P3T MICROLOGIC 2.2 100A NSX100N	C10N32D100	NSX100N 50kAAC 3P3D 100A 2.2	Yes	Yes
LV430776	3P3T MICROLOGIC 2.2 100A NSX160N	C16N32D100	NSX160N 50kAAC 3P3D 100A 2.2	Yes	Yes
LV430775	3P3T MICROLOGIC 2.2 160A NSX160N	C16N32D160	NSX160N 50kAAC 3P3D 160A 2.2	Yes	Yes
LV431872	3P3T MICROLOGIC 2.2 100A NSX250N	C25N32D100	NSX250N 50kAAC 3P3D 100A 2.2	Yes	Yes
LV431871	3P3T MICROLOGIC 2.2 160A NSX250N	C25N32D160	NSX250N 50kAAC 3P3D 160A 2.2	Yes	Yes
LV431870	3P3T MICROLOGIC 2.2 250A NSX250N	C25N32D250	NSX250N 50kAAC 3P3D 250A 2.2	Yes	Yes
LV429867	4P4T TM16D NSX100N	C10N4TM016	NSX100N 50kAAC 4P4D 16A TMD	Yes	Yes
LV429866	4P4T TM25D NSX100N	C10N4TM025	NSX100N 50kAAC 4P4D 25A TMD	Yes	Yes
LV429865	4P4T TM32D NSX100N	C10N4TM032	NSX100N 50kAAC 4P4D 32A TMD	Yes	Yes
LV429864	4P4T TM40D NSX100N	C10N4TM040	NSX100N 50kAAC 4P4D 40A TMD	Yes	Yes
LV430832	3P3T MA150 NSX160N	C16N3MA150	NSX160N 50kAAC 3P3D 150A MA	Yes	Yes
LV431753	3P3T MA150 NSX250N	C25N3MA150	NSX250N 50kAAC 3P3D 150A MA	Yes	Yes
LV431752	3P3T MA220 NSX250N	C25N3MA220	NSX250N 50kAAC 3P3D 220A MA	Yes	Yes
LV429677	3P3T TM16T NSX100H	C10H3TM016	NSX100H 70kAAC 3P3D 16A TMD	Yes	Yes
LV429676	3P3T TM25T NSX100H	C10H3TM025	NSX100H 70kAAC 3P3D 25A TMD	Yes	Yes
LV429675	3P3T TM32T NSX100H	C10H3TM032	NSX100H 70kAAC 3P3D 32A TMD	Yes	Yes
LV429674	3P3T TM40T NSX100H	C10H3TM040	NSX100H 70kAAC 3P3D 40A TMD	Yes	Yes
LV429673	3P3T TM50T NSX100H	C10H3TM050	NSX100H 70kAAC 3P3D 50A TMD	Yes	Yes
LV429672	3P3T TM63T NSX100H	C10H3TM063	NSX100H 70kAAC 3P3D 63A TMD	Yes	Yes
LV429671	3P3T TM80T NSX100H	C10H3TM080	NSX100H 70kAAC 3P3D 80A TMD	Yes	Yes
LV429670	3P3T TM100T NSX100H	C10H3TM100	NSX100H 70kAAC 3P3D 100A TMD	Yes	Yes
LV430673	3P3T TM80T NSX160H	C16H3TM080	NSX160H 70kAAC 3P3D 80A TMD	Yes	Yes
LV430672	3P3T TM100T NSX160H	C16H3TM100	NSX160H 70kAAC 3P3D 100A TMD	Yes	Yes
LV430671	3P3T TM125T NSX160H	C16H3TM125	NSX160H 70kAAC 3P3D 125A TMD	Yes	Yes
LV430670	3P3T TM160T NSX160H	C16H3TM160	NSX160H 70kAAC 3P3D 160A TMD	Yes	Yes
LV431673	3P3T TM125T NSX250H	C25H3TM125	NSX250H 70kAAC 3P3D 125A TMD	Yes	Yes
LV431672	3P3T TM160T NSX250H	C25H3TM160	NSX250H 70kAAC 3P3D 160A TMD	Yes	Yes
LV431671	3P3T TM200T NSX250H	C25H3TM200	NSX250H 70kAAC 3P3D 200A TMD	Yes	Yes
LV431670	3P3T TM250T NSX250H	C25H3TM250	NSX250H 70kAAC 3P3D 250A TMD	Yes	Yes
LV429792	3P3T MICROLOGIC 2.2 40A NSX100H	C10H32D040	NSX100H 70kAAC 3P3D 40A 2.2	Yes	Yes
LV429790	3P3T MICROLOGIC 2.2 100A NSX100H	C10H32D100	NSX100H 70kAAC 3P3D 100A 2.2	Yes	Yes
LV430791	3P3T MICROLOGIC 2.2 100A NSX160H	C16H32D100	NSX160H 70kAAC 3P3D 100A 2.2	Yes	Yes
LV430790	3P3T MICROLOGIC 2.2 160A NSX160H	C16H32D160	NSX160H 70kAAC 3P3D 160A 2.2	Yes	Yes
LV431792	3P3T MICROLOGIC 2.2 100A NSX250H	C25H32D100	NSX250H 70kAAC 3P3D 100A 2.2	Yes	Yes
LV431791	3P3T MICROLOGIC 2.2 160A NSX250H	C25H32D160	NSX250H 70kAAC 3P3D 160A 2.2	Yes	Yes
LV431790	3P3T MICROLOGIC 2.2 250A NSX250H	C25H32D250	NSX250H 70kAAC 3P3D 250A 2.2	Yes	Yes
LV429687	4P3T TM16T NSX100H	C10H6TM016	NSX100H 70kAAC 4P3D 16A TMD	Yes	Yes
LV429686	4P3T TM25T NSX100H	C10H6TM025	NSX100H 70kAAC 4P3D 25A TMD	Yes	Yes
LV429685	4P3T TM32T NSX100H	C10H6TM032	NSX100H 70kAAC 4P3D 32A TMD	Yes	Yes
LV429684	4P3T TM40T NSX100H	C10H6TM040	NSX100H 70kAAC 4P3D 40A TMD	Yes	Yes
LV429683	4P3T TM50T NSX100H	C10H6TM050	NSX100H 70kAAC 4P3D 50A TMD	Yes	Yes
LV429682	4P3T TM63T NSX100H	C10H6TM063	NSX100H 70kAAC 4P3D 63A TMD	Yes	Yes
LV429681	4P3T TM80T NSX100H	C10H6TM080	NSX100H 70kAAC 4P3D 80A TMD	Yes	Yes
LV429680	4P3T TM100T NSX100H	C10H6TM100	NSX100H 70kAAC 4P3D 100A TMD	Yes	Yes
LV430683	4P3T TM80T NSX160H	C16H6TM080	NSX160H 70kAAC 4P3D 80A TMD	Yes	Yes
LV430682	4P3T TM100T NSX160H	C16H6TM100	NSX160H 70kAAC 4P3D 100A TMD	Yes	Yes

Compatibility of Components of Existing and New ComPacT NSX100/160/250

Old ComPact NSX		New ComPact NSX		Compatibility	
Cat. No	Description	Cat. No	Description	Old NSX to New Retrofit NSX	New Retrofit NSX to old NSX
LV430681	4P3T TM125T NSX160H	C16H6TM125	NSX160H 70kAAC 4P3D 125A TMD	Yes	Yes
LV430680	4P3T TM160T NSX160H	C16H6TM160	NSX160H 70kAAC 4P3D 160A TMD	Yes	Yes
LV431683	4P3T TM125T NSX250H	C25H6TM125	NSX250H 70kAAC 4P3D 125A TMD	Yes	Yes
LV431682	4P3T TM160T NSX250H	C25H6TM160	NSX250H 70kAAC 4P3D 160A TMD	Yes	Yes
LV431681	4P3T TM200T NSX250H	C25H6TM200	NSX250H 70kAAC 4P3D 200A TMD	Yes	Yes
LV431680	4P3T TM250T NSX250H	C25H6TM250	NSX250H 70kAAC 4P3D 250A TMD	Yes	Yes
LV429802	4P4T MICROLOGIC 2.2 40A NSX100H	C10H42D040	NSX100H 70kAAC 4P4D 40A 2.2	Yes	Yes
LV429800	4P4T MICROLOGIC 2.2 100A NSX100H	C10H42D100	NSX100H 70kAAC 4P4D 100A 2.2	Yes	Yes
LV430801	4P4T MICROLOGIC 2.2100A NSX160H	C16H42D100	NSX160H 70kAAC 4P4D 100A 2.2	Yes	Yes
LV430800	4P4T MICROLOGIC 2.2160A NSX160H	C16H42D160	NSX160H 70kAAC 4P4D 160A 2.2	Yes	Yes
LV431802	4P4T MICROLOGIC 2.2 100A NSX250H	C25H42D100	NSX250H 70kAAC 4P4D 100A 2.2	Yes	Yes
LV431801	4P4T MICROLOGIC 2.2 160A NSX250H	C25H42D160	NSX250H 70kAAC 4P4D 160A 2.2	Yes	Yes
LV431800	4P4T MICROLOGIC 2.2 250A NSX250H	C25H42D250	NSX250H 70kAAC 4P4D 250A 2.2	Yes	Yes
LV429697	4P4T TM16T NSX100H	C10H4TM016	NSX100H 70kAAC 4P4D 16A TMD	Yes	Yes
LV429696	4P4T TM25T NSX100H	C10H4TM025	NSX100H 70kAAC 4P4D 25A TMD	Yes	Yes
LV429695	4P4T TM32T NSX100H	C10H4TM032	NSX100H 70kAAC 4P4D 32A TMD	Yes	Yes
LV429694	4P4T TM40T NSX100H	C10H4TM040	NSX100H 70kAAC 4P4D 40A TMD	Yes	Yes
LV429693	4P4T TM50T NSX100H	C10H4TM050	NSX100H 70kAAC 4P4D 50A TMD	Yes	Yes
LV429692	4P4T TM63T NSX100H	C10H4TM063	NSX100H 70kAAC 4P4D 63A TMD	Yes	Yes
LV429691	4P4T TM80T NSX100H	C10H4TM080	NSX100H 70kAAC 4P4D 80A TMD	Yes	Yes
LV429690	4P4T TM100T NSX100H	C10H4TM100	NSX100H 70kAAC 4P4D 100A TMD	Yes	Yes
LV430693	4P4T TM80T NSX160H	C16H4TM080	NSX160H 70kAAC 4P4D 80A TMD	Yes	Yes
LV430692	4P4T TM100T NSX160H	C16H4TM100	NSX160H 70kAAC 4P4D 100A TMD	Yes	Yes
LV430691	4P4T TM125T NSX160H	C16H4TM125	NSX160H 70kAAC 4P4D 125A TMD	Yes	Yes
LV430690	4P4T TM160T NSX160H	C16H4TM160	NSX160H 70kAAC 4P4D 160A TMD	Yes	Yes
LV431693	4P4T TM125T NSX250H	C25H4TM125	NSX250H 70kAAC 4P4D 125A TMD	Yes	Yes
LV431692	4P4T TM160T NSX250H	C25H4TM160	NSX250H 70kAAC 4P4D 160A TMD	Yes	Yes
LV431691	4P4T TM200T NSX250H	C25H4TM200	NSX250H 70kAAC 4P4D 200A TMD	Yes	Yes
LV431690	4P4T TM250T NSX250H	C25H4TM250	NSX250H 70kAAC 4P4D 250A TMD	Yes	Yes
LV429765	3P3T MA2.5 NSX100H	C10H3MA003	NSX100H 70kAAC 3P3D 2.5A MA	Yes	Yes
LV429764	3P3T MA6.3 NSX100H	C10H3MA007	NSX100H 70kAAC 3P3D 6.3A MA	Yes	Yes
LV429763	3P3T MA12.5 NSX100H	C10H3MA013	NSX100H 70kAAC 3P3D 12.5A MA	Yes	Yes
LV429762	3P3T MA25 NSX100H	C10H3MA025	NSX100H 70kAAC 3P3D 25A MA	Yes	Yes
LV429761	3P3T MA50 NSX100H	C10H3MA050	NSX100H 70kAAC 3P3D 50A MA	Yes	Yes
LV429760	3P3T MA100 NSX100H	C10H3MA100	NSX100H 70kAAC 3P3D 100A MA	Yes	Yes
LV430835	3P3T MA100 NSX160H	C16H3MA100	NSX160H 70kAAC 3P3D 100A MA	Yes	Yes
LV430834	3P3T MA150 NSX160H	C16H3MA150	NSX160H 70kAAC 3P3D 150A MA	Yes	Yes
LV431757	3P3T MA150 NSX250H	C25H3MA150	NSX250H 70kAAC 3P3D 150A MA	Yes	Yes
LV431756	3P3T MA220 NSX250H	C25H3MA220	NSX250H 70kAAC 3P3D 220A MA	Yes	Yes
LV429838	3P3T MICROLOGIC 2.2 M 25A NSX100H	C10H32M025	NSX100H 70kAAC 3P3D 25A 2.2M	Yes	Yes
LV429837	3P3T MICROLOGIC 2.2 M 50A NSX100H	C10H32M050	NSX100H 70kAAC 3P3D 50A 2.2M	Yes	Yes
LV429835	3P3T MICROLOGIC 2.2 M 100A NSX100H	C10H32M100	NSX100H 70kAAC 3P3D 100A 2.2M	Yes	Yes
LV430992	3P3T MICROLOGIC 2.2 M 100A NSX160H	C16H32M100	NSX160H 70kAAC 3P3D 100A 2.2M	Yes	Yes
LV430991	3P3T MICROLOGIC 2.2 M 150A NSX160H	C16H32M150	NSX160H 70kAAC 3P3D 150A 2.2M	Yes	Yes
LV431171	3P3T MICROLOGIC 2.2 M 150A NSX250H	C25H32M150	NSX250H 70kAAC 3P3D 150A 2.2M	Yes	Yes
LV431170	3P3T MICROLOGIC 2.2 M 220A NSX250H	C25H32M220	NSX250H 70kAAC 3P3D 220A 2.2M	Yes	Yes
LV429619	2P(3P) NSX100NA	C102100S	SWITCH NSX100NAAC 2P 100A	Yes	Yes
LV430619	2P(3P) NSX160NA	C162160S	SWITCH NSX160NAAC 2P 160A	Yes	Yes
LV431619	2P(3P) NSX250NA	C252250S	SWITCH NSX250NAAC 2P 250A	Yes	Yes
LV429629	3P NSX100NA	C103100S	SWITCH NSX100NAAC 3P 100A	Yes	Yes
LV430629	3P NSX160NA	C163160S	SWITCH NSX160NAAC 3P 160A	Yes	Yes
LV431629	3P NSX250NA	C253250S	SWITCH NSX250NAAC 3P 250A	Yes	Yes
LV429639	4P NSX100NA	C104100S	SWITCH NSX100NAAC 4P 100A	Yes	Yes
LV430639	4P NSX160NA	C164160S	SWITCH NSX160NAAC 4P 160A	Yes	Yes
LV431639	4P NSX250NA	C254250S	SWITCH NSX250NAAC 4P 250A	Yes	Yes
LV429014	3P NSX100B WITHOUT TRIP UNIT COMPACT CI	C10B3	BASIC FRAME NSX100B 25kAAC 3P 100A	Yes	Yes
LV429003	3P NSX100F WITHOUT TRIP UNIT COMPACT CI	C10F3	BASIC FRAME NSX100F 36kAAC 3P 100A	Yes	Yes
LV429006	3P NSX100N WITHOUT TRIP UNIT COMPACT CI	C10N3	BASIC FRAME NSX100N 50kAAC 3P 100A	Yes	Yes

Compatibility of Components of Existing and New ComPacT NSX100/160/250

Old ComPacT NSX		New ComPacT NSX		Compatibility	
Cat. No	Description	Cat. No	Description	Old NSX to New Retrofit NSX	New Retrofit NSX to old NSX
LV429004	3P NSX100H WITHOUT TRIP UNIT COMPACT CI	C10H3	BASIC FRAME NSX100H 70kAAC 3P 100A	Yes	Yes
LV429018	3P NSX100S WITHOUT TRIP UNIT COMPACT CI	C10S3	BASIC FRAME NSX100S 100kAAC 3P 100A	Yes	Yes
LV429005	3P NSX100L WITHOUT TRIP UNIT COMPACT CI	C10L3	BASIC FRAME NSX100L 150kAAC 3P 100A	Yes	Yes
LV430390	3P NSX160B WITHOUT TRIP UNIT COMPACT CI	C16B3	BASIC FRAME NSX160B 25kAAC 3P 160A	Yes	Yes
LV430403	3P NSX160F WITHOUT TRIP UNIT COMPACT CI	C16F3	BASIC FRAME NSX160F 36kAAC 3P 160A	Yes	Yes
LV430406	3P NSX160N WITHOUT TRIP UNIT COMPACT CI	C16N3	BASIC FRAME NSX160N 50kAAC 3P 160A	Yes	Yes
LV430404	3P NSX160H WITHOUT TRIP UNIT COMPACT CI	C16H3	BASIC FRAME NSX160H 70kAAC 3P 160A	Yes	Yes
LV430391	3P NSX160S WITHOUT TRIP UNIT COMPACT CI	C16S3	BASIC FRAME NSX160S 100kAAC 3P 160A	Yes	Yes
LV430405	3P NSX160L WITHOUT TRIP UNIT COMPACT CI	C16L3	BASIC FRAME NSX160L 150kAAC 3P 160A	Yes	Yes
LV431390	3P NSX250B WITHOUT TRIP UNIT COMPACT CI	C25B3	BASIC FRAME NSX250B 25kAAC 3P 250A	Yes	Yes
LV431403	3P NSX250F WITHOUT TRIP UNIT COMPACT CI	C25F3	BASIC FRAME NSX250F 36kAAC 3P 250A	Yes	Yes
LV431406	3P NSX250N WITHOUT TRIP UNIT COMPACT CI	C25N3	BASIC FRAME NSX250N 50kAAC 3P 250A	Yes	Yes
LV431404	3P NSX250H WITHOUT TRIP UNIT COMPACT CI	C25H3	BASIC FRAME NSX250H 70kAAC 3P 250A	Yes	Yes
LV431391	3P NSX250S WITHOUT TRIP UNIT COMPACT CI	C25S3	BASIC FRAME NSX250S 100kAAC 3P 250A	Yes	Yes
LV431405	3P NSX250L WITHOUT TRIP UNIT COMPACT CI	C25L3	BASIC FRAME NSX250L 150kAAC 3P 250A	Yes	Yes
LV429037	3P3D TM16D TRIP UNIT	C103TM016	TRIP UNIT NSX100 AC 3P3D 16A TMD	Yes	Yes
LV429036	3P3D TM25D TRIP UNIT	C103TM025	TRIP UNIT NSX100 AC 3P3D 25A TMD	Yes	Yes
LV429035	3P3D TM32D TRIP UNIT	C103TM032	TRIP UNIT NSX100 AC 3P3D 32A TMD	Yes	Yes
LV429034	3P3D TM40D TRIP UNIT	C103TM040	TRIP UNIT NSX100 AC 3P3D 40A TMD	Yes	Yes
LV429033	3P3D TM50D TRIP UNIT	C103TM050	TRIP UNIT NSX100 AC 3P3D 50A TMD	Yes	Yes
LV429032	3P3D TM63D TRIP UNIT	C103TM063	TRIP UNIT NSX100 AC 3P3D 63A TMD	Yes	Yes
LV429031	3P3D TM80D TRIP UNIT	C103TM080	TRIP UNIT NSX100 AC 3P3D 80A TMD	Yes	Yes
LV429030	3P3D TM100D TRIP UNIT	C103TM100	TRIP UNIT NSX100 AC 3P3D 100A TMD	Yes	Yes
LV430431	3P3D TM125D TRIP UNIT	C163TM125	TRIP UNIT NSX160 AC 3P3D 125A TMD	Yes	Yes
LV430430	3P3D TM160D TRIP UNIT	C163TM160	TRIP UNIT NSX160 AC 3P3D 160A TMD	Yes	Yes
LV431432	3P3T TM160D TRIP UNIT	C253TM160	TRIP UNIT NSX250 AC 3P3D 160A TMD	Yes	Yes
LV431431	3P3T TM200D TRIP UNIT	C253TM200	TRIP UNIT NSX250 AC 3P3D 200A TMD	Yes	Yes
LV431430	3P3T TM250D TRIP UNIT	C253TM250	TRIP UNIT NSX250 AC 3P3D 250A TMD	Yes	Yes
LV429072	3P3T MICROLOGIC 2.2 40A TRIP UNIT	C1032D040	TRIP UNIT NSX100 AC 3P3D 40A 2.2	Yes	Yes
LV429070	3P3T MICROLOGIC 2.2 100A TRIP UNIT	C1032D100	TRIP UNIT NSX100 AC 3P3D 100A 2.2	Yes	Yes
LV430470	3P3T MICROLOGIC 2.2 160A TRIP UNIT	C1632D160	TRIP UNIT NSX160 AC 3P3D 160A 2.2	Yes	Yes
LV431470	3P3T MICROLOGIC 2.2 250A TRIP UNIT	C2532D250	TRIP UNIT NSX250 AC 3P3D 250A 2.2	Yes	Yes
LV429096	3P3T MICROLOGIC 5.2 E 40A TRIP UNIT	C1035E040	TRIP UNIT NSX100 AC 3P3D 40A 5.2E	Yes	Yes
LV429095	3P3T MICROLOGIC 5.2 E 100A TRIP UNIT	C1035E100	TRIP UNIT NSX100 AC 3P3D 100A 5.2E	Yes	Yes
LV430491	3P3T MICROLOGIC 5.2 E 160A TRIP UNIT	C1635E160	TRIP UNIT NSX160 AC 3P3D 160A 5.2E	Yes	Yes
LV431491	3P3T MICROLOGIC 5.2 E 250A TRIP UNIT	C2535E250	TRIP UNIT NSX250 AC 3P3D 250A 5.2E	Yes	Yes
LV429116	3P3T MICROLOGIC 6.2 E 40A TRIP UNIT	C1036E040	TRIP UNIT NSX100 AC 3P3D 40A 6.2E	Yes	Yes
LV429115	3P3T MICROLOGIC 6.2 E 100A TRIP UNIT	C1036E100	TRIP UNIT NSX100 AC 3P3D 100A 6.2E	Yes	Yes
LV430506	3P3T MICROLOGIC 6.2 E 160A TRIP UNIT	C1636E160	TRIP UNIT NSX160 AC 3P3D 160A 6.2E	Yes	Yes
LV431506	3P3T MICROLOGIC 6.2 E 250A TRIP UNIT	C2536E250	TRIP UNIT NSX250 AC 3P3D 250A 6.2E	Yes	Yes
LV429015	4P NSX100B WITHOUT TRIP UNIT COMPACT CI	C10B4	BASIC FRAME NSX100B 25kAAC 4P 100A	Yes	Yes
LV429008	4P NSX100F WITHOUT TRIP UNIT COMPACT CI	C10F4	BASIC FRAME NSX100F 36kAAC 4P 100A	Yes	Yes
LV429011	4P NSX100N WITHOUT TRIP UNIT COMPACT CI	C10N4	BASIC FRAME NSX100N 50kAAC 4P 100A	Yes	Yes
LV429009	4P NSX100H WITHOUT TRIP UNIT COMPACT CI	C10H4	BASIC FRAME NSX100H 70kAAC 4P 100A	Yes	Yes
LV429019	4P NSX100S WITHOUT TRIP UNIT COMPACT CI	C10S4	BASIC FRAME NSX100S 100kAAC 4P 100A	Yes	Yes
LV429010	4P NSX100L WITHOUT TRIP UNIT COMPACT CI	C10L4	BASIC FRAME NSX100L 150kAAC 4P 100A	Yes	Yes
LV430395	4P NSX160B WITHOUT TRIP UNIT COMPACT CI	C16B4	BASIC FRAME NSX160B 25kAAC 4P 160A	Yes	Yes
LV430408	4P NSX160F WITHOUT TRIP UNIT COMPACT CI	C16F4	BASIC FRAME NSX160F 36kAAC 4P 160A	Yes	Yes
LV430411	4P NSX160N WITHOUT TRIP UNIT COMPACT CI	C16N4	BASIC FRAME NSX160N 50kAAC 4P 160A	Yes	Yes
LV430409	4P NSX160H WITHOUT TRIP UNIT COMPACT CI	C16H4	BASIC FRAME NSX160H 70kAAC 4P 160A	Yes	Yes
LV430396	4P NSX160S WITHOUT TRIP UNIT COMPACT CI	C16S4	BASIC FRAME NSX160S 100kAAC 4P 160A	Yes	Yes
LV430410	4P NSX160L WITHOUT TRIP UNIT COMPACT CI	C16L4	BASIC FRAME NSX160L 150kAAC 4P 160A	Yes	Yes
LV431395	4P NSX250B WITHOUT TRIP UNIT COMPACT CI	C25B4	BASIC FRAME NSX250B 25kAAC 4P 250A	Yes	Yes
LV431408	4P NSX250F WITHOUT TRIP UNIT COMPACT CI	C25F4	BASIC FRAME NSX250F 36kAAC 4P 250A	Yes	Yes
LV431411	4P NSX250N WITHOUT TRIP UNIT COMPACT CI	C25N4	BASIC FRAME NSX250N 50kAAC 4P 250A	Yes	Yes
LV431409	4P NSX250H WITHOUT TRIP UNIT COMPACT CI	C25H4	BASIC FRAME NSX250H 70kAAC 4P 250A	Yes	Yes
LV431396	4P NSX250S WITHOUT TRIP UNIT COMPACT CI	C25S4	BASIC FRAME NSX250S 100kAAC 4P 250A	Yes	Yes
LV431410	4P NSX250L WITHOUT TRIP UNIT COMPACT CI	C25L4	BASIC FRAME NSX250L 150kAAC 4P 250A	Yes	Yes

Compatibility of Components of Existing and New ComPacT NSX100/160/250

Old ComPact NSX		New ComPacT NSX		Compatibility	
Cat. No	Description	Cat. No	Description	Old NSX to New Retrofit NSX	New Retrofit NSX to old NSX
LV429047	4P3T TM16D TRIP UNIT	C106TM016	TRIP UNIT NSX100 AC 4P3D 16A TMD	Yes	Yes
LV429046	4P3T TM25D TRIP UNIT	C106TM025	TRIP UNIT NSX100 AC 4P3D 25A TMD	Yes	Yes
LV429045	4P3T TM32D TRIP UNIT	C106TM032	TRIP UNIT NSX100 AC 4P3D 32A TMD	Yes	Yes
LV429044	4P3T TM40D TRIP UNIT	C106TM040	TRIP UNIT NSX100 AC 4P3D 40A TMD	Yes	Yes
LV429043	4P3T TM50D TRIP UNIT	C106TM050	TRIP UNIT NSX100 AC 4P3D 50A TMD	Yes	Yes
LV429042	4P3T TM63D TRIP UNIT	C106TM063	TRIP UNIT NSX100 AC 4P3D 63A TMD	Yes	Yes
LV429041	4P3T TM80D TRIP UNIT	C106TM080	TRIP UNIT NSX100 AC 4P3D 80A TMD	Yes	Yes
LV429040	4P3T TM100D TRIP UNIT	C106TM100	TRIP UNIT NSX100 AC 4P3D 100A TMD	Yes	Yes
LV430441	4P3T TM125D TRIP UNIT	C166TM125	TRIP UNIT NSX160 AC 4P3D 125A TMD	Yes	Yes
LV430440	4P3T TM160D TRIP UNIT	C166TM160	TRIP UNIT NSX160 AC 4P3D 160A TMD	Yes	Yes
LV431442	4P3T TM160D TRIP UNIT	C256TM160	TRIP UNIT NSX250 AC 4P3D 160A TMD	Yes	Yes
LV431441	4P3T TM200D TRIP UNIT	C256TM200	TRIP UNIT NSX250 AC 4P3D 200A TMD	Yes	Yes
LV431440	4P3T TM250D TRIP UNIT	C256TM250	TRIP UNIT NSX250 AC 4P3D 250A TMD	Yes	Yes
LV429082	4P4T MICROLOGIC 2.2 40A TRIP UNIT	C1042D040	TRIP UNIT NSX100 AC 4P4D 40A 2.2	Yes	Yes
LV429080	4P4T MICROLOGIC 2.2 100A TRIP UNIT	C1042D100	TRIP UNIT NSX100 AC 4P4D 100A 2.2	Yes	Yes
LV430480	4P4T MICROLOGIC 2.2 160A TRIP UNIT	C1642D160	TRIP UNIT NSX160 AC 4P4D 160A 2.2	Yes	Yes
LV431480	4P4T MICROLOGIC 2.2 250A TRIP UNIT	C2542D250	TRIP UNIT NSX250 AC 4P4D 250A 2.2	Yes	Yes
LV429106	4P4T MICROLOGIC 5.2 E 40A TRIP UNIT	C1045E040	TRIP UNIT NSX100 AC 4P4D 40A 5.2E	Yes	Yes
LV429105	4P4T MICROLOGIC 5.2 E 100A TRIP UNIT	C1045E100	TRIP UNIT NSX100 AC 4P4D 100A 5.2E	Yes	Yes
LV430496	4P4T MICROLOGIC 5.2 E 160A TRIP UNIT	C1645E160	TRIP UNIT NSX160 AC 4P4D 160A 5.2E	Yes	Yes
LV431496	4P4T MICROLOGIC 5.2 E 250A TRIP UNIT	C2545E250	TRIP UNIT NSX250 AC 4P4D 250A 5.2E	Yes	Yes
LV429141	4P4T MICROLOGIC 6.2 E 40A TRIP UNIT	C1046E040	TRIP UNIT NSX100 AC 4P4D 40A 6.2E	Yes	Yes
LV429140	4P4T MICROLOGIC 6.2 E 100A TRIP UNIT	C1046E100	TRIP UNIT NSX100 AC 4P4D 100A 6.2E	Yes	Yes
LV430516	4P4T MICROLOGIC 6.2 E 160A TRIP UNIT	C1646E160	TRIP UNIT NSX160 AC 4P4D 160A 6.2E	Yes	Yes
LV431516	4P4T MICROLOGIC 6.2 E 250A TRIP UNIT	C2546E250	TRIP UNIT NSX250 AC 4P4D 250A 6.2E	Yes	Yes
LV429057	4P4T TM16D TRIP UNIT	C104TM016	TRIP UNIT NSX100 AC 4P4D 16A TMD	Yes	Yes
LV429056	4P4T TM25D TRIP UNIT	C104TM025	TRIP UNIT NSX100 AC 4P4D 25A TMD	Yes	Yes
LV429055	4P4T TM32D TRIP UNIT	C104TM032	TRIP UNIT NSX100 AC 4P4D 32A TMD	Yes	Yes
LV429054	4P4T TM40D TRIP UNIT	C104TM040	TRIP UNIT NSX100 AC 4P4D 40A TMD	Yes	Yes
LV429053	4P4T TM50D TRIP UNIT	C104TM050	TRIP UNIT NSX100 AC 4P4D 50A TMD	Yes	Yes
LV429052	4P4T TM63D TRIP UNIT	C104TM063	TRIP UNIT NSX100 AC 4P4D 63A TMD	Yes	Yes
LV429051	4P4T TM80D TRIP UNIT	C104TM080	TRIP UNIT NSX100 AC 4P4D 80A TMD	Yes	Yes
LV429050	4P4T TM100D TRIP UNIT	C104TM100	TRIP UNIT NSX100 AC 4P4D 100A TMD	Yes	Yes
LV430451	4P4T TM125D TRIP UNIT	C164TM125	TRIP UNIT NSX160 AC 4P4D 125A TMD	Yes	Yes
LV430450	4P4T TM160D TRIP UNIT	C164TM160	TRIP UNIT NSX160 AC 4P4D 160A TMD	Yes	Yes
LV431452	4P4T TM160D TRIP UNIT	C254TM160	TRIP UNIT NSX250 AC 4P4D 160A TMD	Yes	Yes
LV431451	4P4T TM200D TRIP UNIT	C254TM200	TRIP UNIT NSX250 AC 4P4D 200A TMD	Yes	Yes
LV431450	4P4T TM250D TRIP UNIT	C254TM250	TRIP UNIT NSX250 AC 4P4D 250A TMD	Yes	Yes
LV429125	3P3D MA2.5 TRIP UNIT	C103MA003	TRIP UNIT NSX100 AC 3P3D 2.5A MA	Yes	Yes
LV429124	3P3D MA6.3 TRIP UNIT	C103MA007	TRIP UNIT NSX100 AC 3P3D 6.3A MA	Yes	Yes
LV429123	3P3D MA12.5 TRIP UNIT	C103MA013	TRIP UNIT NSX100 AC 3P3D 12.5A MA	Yes	Yes
LV429122	3P3D MA25 TRIP UNIT	C103MA025	TRIP UNIT NSX100 AC 3P3D 25A MA	Yes	Yes
LV429121	3P3D MA50 TRIP UNIT	C103MA050	TRIP UNIT NSX100 AC 3P3D 50A MA	Yes	Yes
LV429120	3P3D MA100 TRIP UNIT	C103MA100	TRIP UNIT NSX100 AC 3P3D 100A MA	Yes	Yes
LV430500	3P3D MA150 TRIP UNIT	C163MA150	TRIP UNIT NSX160 AC 3P3D 150A MA	Yes	Yes
LV431500	3P3D MA220 TRIP UNIT	C253MA220	TRIP UNIT NSX250 AC 3P3D 220A MA	Yes	Yes
LV429174	3P3T MICROLOGIC 2.2 M 25A TRIP UNIT	C1032M025	TRIP UNIT NSX100 AC 3P3D 25A 2.2M	Yes	Yes
LV429172	3P3T MICROLOGIC 2.2 M 50A TRIP UNIT	C1032M050	TRIP UNIT NSX100 AC 3P3D 50A 2.2M	Yes	Yes
LV429170	3P3T MICROLOGIC 2.2 M 100A TRIP UNIT	C1032M100	TRIP UNIT NSX100 AC 3P3D 100A 2.2M	Yes	Yes
LV430520	3P3T MICROLOGIC 2.2 M 150A TRIP UNIT	C1632M150	TRIP UNIT NSX160 AC 3P3D 150A 2.2M	Yes	Yes
LV431485	4P4T MICROLOGIC 2.2 G 250A TRIP UNIT	C2542G250	TRIP UNIT NSX250 AC 4P4D 250A 2.2G	Yes	Yes
LV434550	4P4T MICROLOGIC 2.2 AB 100A TRIP UNIT	C1042B100	TRIP UNIT NSX100 AC 4P4D 100A 2.2AB	Yes	Yes
LV434551	4P4T MICROLOGIC 2.2 AB 160A TRIP UNIT	C1642B160	TRIP UNIT NSX160 AC 4P4D 160A 2.2AB	Yes	Yes
LV434554	4P4T MICROLOGIC 2.2 AB 240A TRIP UNIT	C2542B240	TRIP UNIT NSX250 AC 4P4D 240A 2.2AB	Yes	Yes
LV433200	NSX100R CIRCUIT BREAKER TMD	C10R3TM040	NSX100R 200kAAC 3P 40A TMD	Yes	Yes
LV433202	NSX100R CIRCUIT BREAKER TMD	C10R3TM050	NSX100R 200kAAC 3P 50A TMD	Yes	Yes
LV433204	NSX100R CIRCUIT BREAKER TMD	C10R3TM063	NSX100R 200kAAC 3P 63A TMD	Yes	Yes
LV433206	NSX100R CIRCUIT BREAKER TMD	C10R3TM080	NSX100R 200kAAC 3P 80A TMD	Yes	Yes

Compatibility of Components of Existing and New ComPacT NSX100/160/250

Old ComPacT NSX		New ComPacT NSX		Compatibility	
Cat. No	Description	Cat. No	Description	Old NSX to New Retrofit NSX	New Retrofit NSX to Old NSX
LV433208	NSX100R CIRCUIT BREAKER TMD	C10R3TM100	NSX100R 200kAAC 3P 100A TMD	Yes	Yes
LV433470	NSX250R CIRCUIT BREAKER TMD	C25R3TM125	NSX250R 200kAAC 3P 125A TMD	Yes	Yes
LV433472	NSX250R CIRCUIT BREAKER TMD	C25R3TM160	NSX250R 200kAAC 3P 160A TMD	Yes	Yes
LV433474	NSX250R CIRCUIT BREAKER TMD	C25R3TM200	NSX250R 200kAAC 3P 200A TMD	Yes	Yes
LV433476	NSX250R CIRCUIT BREAKER TMD	C25R3TM250	NSX250R 200kAAC 3P 250A TMD	Yes	Yes
LV433270	NSX100R CIRCUIT BREAKER 2.2	C10R32D040	NSX100R 200kAAC 3P 40A 2.2	Yes	Yes
LV433272	NSX100R CIRCUIT BREAKER 2.2	C10R32D100	NSX100R 200kAAC 3P 100A 2.2	Yes	Yes
LV433510	NSX250R CIRCUIT BREAKER 2.2 100A 3P	C25R32D100	NSX250R 200kAAC 3P 100A 2.2	Yes	Yes
LV433512	NSX250R CIRCUIT BREAKER 2.2 160A 3P	C25R32D160	NSX250R 200kAAC 3P 160A 2.2	Yes	Yes
LV433514	NSX250R CIRCUIT BREAKER 2.2 250A 3P	C25R32D250	NSX250R 200kAAC 3P 250A 2.2	Yes	Yes
LV433277	NSX100R CIRCUIT BREAKER 5.2 E	C10R35E040	NSX100R 200kAAC 3P 40A 5.2E	Yes	Yes
LV433279	NSX100R CIRCUIT BREAKER 5.2 E	C10R35E100	NSX100R 200kAAC 3P 100A 5.2E	Yes	Yes
LV433518	NSX250R CIRCUIT BREAKER 5.2 E	C25R35E100	NSX250R 200kAAC 3P 100A 5.2E	Yes	Yes
LV433520	NSX250R CIRCUIT BREAKER 5.2 E	C25R35E160	NSX250R 200kAAC 3P 160A 5.2E	Yes	Yes
LV433522	NSX250R CIRCUIT BREAKER 5.2 E	C25R35E250	NSX250R 200kAAC 3P 250A 5.2E	Yes	Yes
LV433281	NSX100R CIRCUIT BREAKER 6.2 E	C10R36E040	NSX100R 200kAAC 3P 40A 6.2E	Yes	Yes
LV433283	NSX100R CIRCUIT BREAKER 6.2 E	C10R36E100	NSX100R 200kAAC 3P 100A 6.2E	Yes	Yes
LV433524	NSX250R CIRCUIT BREAKER 6.2 E 100A 3P	C25R36E100	NSX250R 200kAAC 3P 100A 6.2E	Yes	Yes
LV433526	NSX250R CIRCUIT BREAKER 6.2 E 160A 3P	C25R36E160	NSX250R 200kAAC 3P 160A 6.2E	Yes	Yes
LV433528	NSX250R CIRCUIT BREAKER 6.2 E 250A 3P	C25R36E250	NSX250R 200kAAC 3P 250A 6.2E	Yes	Yes
LV433201	NSX100R CIRCUIT BREAKER TMD	C10R4TM040	NSX100R 200kAAC 4P 40A TMD	Yes	Yes
LV433203	NSX100R CIRCUIT BREAKER TMD	C10R4TM050	NSX100R 200kAAC 4P 50A TMD	Yes	Yes
LV433205	NSX100R CIRCUIT BREAKER TMD	C10R4TM063	NSX100R 200kAAC 4P 63A TMD	Yes	Yes
LV433207	NSX100R CIRCUIT BREAKER TMD	C10R4TM080	NSX100R 200kAAC 4P 80A TMD	Yes	Yes
LV433209	NSX100R CIRCUIT BREAKER TMD	C10R4TM100	NSX100R 200kAAC 4P 100A TMD	Yes	Yes
LV433471	NSX250R CIRCUIT BREAKER TMD	C25R4TM125	NSX250R 200kAAC 4P 125A TMD	Yes	Yes
LV433473	NSX250R CIRCUIT BREAKER TMD	C25R4TM160	NSX250R 200kAAC 4P 160A TMD	Yes	Yes
LV433475	NSX250R CIRCUIT BREAKER TMD	C25R4TM200	NSX250R 200kAAC 4P 200A TMD	Yes	Yes
LV433477	NSX250R CIRCUIT BREAKER TMD	C25R4TM250	NSX250R 200kAAC 4P 250A TMD	Yes	Yes
LV433271	NSX100R CIRCUIT BREAKER 2.2	C10R42D040	NSX100R 200kAAC 4P 40A 2.2	Yes	Yes
LV433273	NSX100R CIRCUIT BREAKER 2.2	C10R42D100	NSX100R 200kAAC 4P 100A 2.2	Yes	Yes
LV433511	NSX250R CIRCUIT BREAKER 2.2 100A 4P	C25R42D100	NSX250R 200kAAC 4P 100A 2.2	Yes	Yes
LV433513	NSX250R CIRCUIT BREAKER 2.2 160A 4P	C25R42D160	NSX250R 200kAAC 4P 160A 2.2	Yes	Yes
LV433515	NSX250R CIRCUIT BREAKER 2.2 250A 4P	C25R42D250	NSX250R 200kAAC 4P 250A 2.2	Yes	Yes
LV433278	NSX100R CIRCUIT BREAKER 5.2 E	C10R45E040	NSX100R 200kAAC 4P 40A 5.2E	Yes	Yes
LV433280	NSX100R CIRCUIT BREAKER 5.2 E	C10R45E100	NSX100R 200kAAC 4P 100A 5.2E	Yes	Yes
LV433519	NSX250R CIRCUIT BREAKER 5.2 E 100A 4P	C25R45E100	NSX250R 200kAAC 4P 100A 5.2E	Yes	Yes
LV433521	NSX250R CIRCUIT BREAKER 5.2 E 160A 4P	C25R45E160	NSX250R 200kAAC 4P 160A 5.2E	Yes	Yes
LV433523	NSX250R CIRCUIT BREAKER 5.2 E 250A 4P	C25R45E250	NSX250R 200kAAC 4P 250A 5.2E	Yes	Yes
LV433282	NSX100R CIRCUIT BREAKER 6.2 E	C10R46E040	NSX100R 200kAAC 4P 40A 6.2E	Yes	Yes
LV433284	NSX100R CIRCUIT BREAKER 6.2 E	C10R46E100	NSX100R 200kAAC 4P 100A 6.2E	Yes	Yes
LV433525	NSX250R CIRCUIT BREAKER 6.2 E 100A 4P	C25R46E100	NSX250R 200kAAC 4P 100A 6.2E	Yes	Yes
LV433527	NSX250R CIRCUIT BREAKER 6.2 E 160A 4P	C25R46E160	NSX250R 200kAAC 4P 160A 6.2E	Yes	Yes
LV433529	NSX250R CIRCUIT BREAKER 6.2 E 250A 4P	C25R46E250	NSX250R 200kAAC 4P 250A 6.2E	Yes	Yes
LV433242	NSX100R CIRCUIT BREAKER MA	C10R3MA013	NSX100R 200kAAC 3P 12.5A MA	Yes	Yes
LV433243	NSX100R CIRCUIT BREAKER MA	C10R3MA025	NSX100R 200kAAC 3P 25A MA	Yes	Yes
LV433244	NSX100R CIRCUIT BREAKER MA	C10R3MA050	NSX100R 200kAAC 3P 50A MA	Yes	Yes
LV433245	NSX100R CIRCUIT BREAKER MA	C10R3MA100	NSX100R 200kAAC 3P 100A MA	Yes	Yes
LV433500	NSX250R CIRCUIT BREAKER MA	C25R3MA150	NSX250R 200kAAC 3P 150A MA	Yes	Yes
LV433501	NSX250R CIRCUIT BREAKER MA	C25R3MA220	NSX250R 200kAAC 3P 220A MA	Yes	Yes
LV433274	NSX100R CIRCUIT BREAKER 2.2 M	C10R32M025	NSX100R 200kAAC 3P 25A 2.2M	Yes	Yes
LV433275	NSX100R CIRCUIT BREAKER 2.2 M	C10R32M050	NSX100R 200kAAC 3P 50A 2.2M	Yes	Yes
LV433276	NSX100R CIRCUIT BREAKER 2.2 M	C10R32M100	NSX100R 200kAAC 3P 100A 2.2M	Yes	Yes
LV433516	NSX250R CIRCUIT BREAKER 2.2 M 150A 3P	C25R32M150	NSX250R 200kAAC 3P 150A 2.2M	Yes	Yes
LV433517	NSX250R CIRCUIT BREAKER 2.2 M 220A 3P	C25R32M220	NSX250R 200kAAC 3P 220A 2.2M	Yes	Yes
LV433285	NSX100R CIRCUIT BREAKER 6.2 EM	C10R36M025	NSX100R 200kAAC 3P 25A 6.2EM	Yes	Yes
LV433286	NSX100R CIRCUIT BREAKER 6.2 EM	C10R36M050	NSX100R 200kAAC 3P 50A 6.2EM	Yes	Yes
LV433287	NSX100R CIRCUIT BREAKER 6.2 EM	C10R36M080	NSX100R 200kAAC 3P 80A 6.2EM	Yes	Yes

Compatibility of Components of Existing and New ComPacT NSX100/160/250

Old ComPact NSX		New ComPacT NSX		Compatibility	
Cat. No	Description	Cat. No	Description	Old NSX to New Retrofit NSX	New Retrofit NSX to old NSX
LV433530	NSX250R CIRCUIT BREAKER 6.2 EM 150A 3P	C25R36M150	NSX250R 200kAAC 3P 150A 6.2EM	Yes	Yes
LV433531	NSX250R CIRCUIT BREAKER 6.2 EM 220A 3P	C25R36M220	NSX250R 200kAAC 3P 220A 6.2EM	Yes	Yes
LV433210	NSX100HB1 CIRCUIT BREAKER TMD	C10V3TM040	NSX100HB1 75kAAC 3P 40A TMD	Yes	Yes
LV433212	NSX100HB1 CIRCUIT BREAKER TMD	C10V3TM050	NSX100HB1 75kAAC 3P 50A TMD	Yes	Yes
LV433214	NSX100HB1 CIRCUIT BREAKER TMD	C10V3TM063	NSX100HB1 75kAAC 3P 63A TMD	Yes	Yes
LV433216	NSX100HB1 CIRCUIT BREAKER TMD	C10V3TM080	NSX100HB1 75kAAC 3P 80A TMD	Yes	Yes
LV433218	NSX100HB1 CIRCUIT BREAKER TMD	C10V3TM100	NSX100HB1 75kAAC 3P 100A TMD	Yes	Yes
LV433478	NSX250HB1 CIRCUIT BREAKER TMD	C25V3TM125	NSX250HB1 75kAAC 3P 125A TMD	Yes	Yes
LV433480	NSX250HB1 CIRCUIT BREAKER TMD	C25V3TM160	NSX250HB1 75kAAC 3P 160A TMD	Yes	Yes
LV433482	NSX250HB1 CIRCUIT BREAKER TMD	C25V3TM200	NSX250HB1 75kAAC 3P 200A TMD	Yes	Yes
LV433484	NSX250HB1 CIRCUIT BREAKER TMD	C25V3TM250	NSX250HB1 75kAAC 3P 250A TMD	Yes	Yes
LV433300	NSX100HB1 CIRCUIT BREAKER 2.2	C10V32D040	NSX100HB1 75kAAC 3P 40A 2.2	Yes	Yes
LV433302	NSX100HB1 CIRCUIT BREAKER 2.2	C10V32D100	NSX100HB1 75kAAC 3P 100A 2.2	Yes	Yes
LV433540	NSX250HB1 CIRCUIT BREAKER 2.2 100A 3P	C25V32D100	NSX250HB1 75kAAC 3P 100A 2.2	Yes	Yes
LV433542	NSX250HB1 CIRCUIT BREAKER 2.2 160A 3P	C25V32D160	NSX250HB1 75kAAC 3P 160A 2.2	Yes	Yes
LV433544	NSX250HB1 CIRCUIT BREAKER 2.2 250A 3P	C25V32D250	NSX250HB1 75kAAC 3P 250A 2.2	Yes	Yes
LV433307	NSX100HB1 CIRCUIT BREAKER 5.2 E	C10V35E040	NSX100HB1 75kAAC 3P 40A 5.2E	Yes	Yes
LV433309	NSX100HB1 CIRCUIT BREAKER 5.2 E	C10V35E100	NSX100HB1 75kAAC 3P 100A 5.2E	Yes	Yes
LV433548	NSX250HB1 CIRCUIT BREAKER 5.2 E	C25V35E100	NSX250HB1 75kAAC 3P 100A 5.2E	Yes	Yes
LV433550	NSX250HB1 CIRCUIT BREAKER 5.2 E	C25V35E160	NSX250HB1 75kAAC 3P 160A 5.2E	Yes	Yes
LV433552	NSX250HB1 CIRCUIT BREAKER 5.2 E	C25V35E250	NSX250HB1 75kAAC 3P 250A 5.2E	Yes	Yes
LV433311	NSX100HB1 CIRCUIT BREAKER 6.2 E	C10V36E040	NSX100HB1 75kAAC 3P 40A 6.2E	Yes	Yes
LV433313	NSX100HB1 CIRCUIT BREAKER 6.2 E	C10V36E100	NSX100HB1 75kAAC 3P 100A 6.2E	Yes	Yes
LV433554	NSX250HB1 CIRCUIT BREAKER 6.2 E 100A 3P	C25V36E100	NSX250HB1 75kAAC 3P 100A 6.2E	Yes	Yes
LV433556	NSX250HB1 CIRCUIT BREAKER 6.2 E 160A 3P	C25V36E160	NSX250HB1 75kAAC 3P 160A 6.2E	Yes	Yes
LV433558	NSX250HB1 CIRCUIT BREAKER 6.2 E 250A 3P	C25V36E250	NSX250HB1 75kAAC 3P 250A 6.2E	Yes	Yes
LV433211	NSX100HB1 CIRCUIT BREAKER TMD	C10V4TM040	NSX100HB1 75kAAC 4P 40A TMD	Yes	Yes
LV433213	NSX100HB1 CIRCUIT BREAKER TMD	C10V4TM050	NSX100HB1 75kAAC 4P 50A TMD	Yes	Yes
LV433215	NSX100HB1 CIRCUIT BREAKER TMD	C10V4TM063	NSX100HB1 75kAAC 4P 63A TMD	Yes	Yes
LV433217	NSX100HB1 CIRCUIT BREAKER TMD	C10V4TM080	NSX100HB1 75kAAC 4P 80A TMD	Yes	Yes
LV433219	NSX100HB1 CIRCUIT BREAKER TMD	C10V4TM100	NSX100HB1 75kAAC 4P 100A TMD	Yes	Yes
LV433479	NSX250HB1 CIRCUIT BREAKER TMD	C25V4TM125	NSX250HB1 75kAAC 4P 125A TMD	Yes	Yes
LV433481	NSX250HB1 CIRCUIT BREAKER TMD	C25V4TM160	NSX250HB1 75kAAC 4P 160A TMD	Yes	Yes
LV433483	NSX250HB1 CIRCUIT BREAKER TMD	C25V4TM200	NSX250HB1 75kAAC 4P 200A TMD	Yes	Yes
LV433485	NSX250HB1 CIRCUIT BREAKER TMD	C25V4TM250	NSX250HB1 75kAAC 4P 250A TMD	Yes	Yes
LV433301	NSX100HB1 CIRCUIT BREAKER 2.2	C10V42D040	NSX100HB1 75kAAC 4P 40A 2.2	Yes	Yes
LV433303	NSX100HB1 CIRCUIT BREAKER 2.2	C10V42D100	NSX100HB1 75kAAC 4P 100A 2.2	Yes	Yes
LV433541	NSX250HB1 CIRCUIT BREAKER 2.2 100A 4P	C25V42D100	NSX250HB1 75kAAC 4P 100A 2.2	Yes	Yes
LV433543	NSX250HB1 CIRCUIT BREAKER 2.2 160A 4P	C25V42D160	NSX250HB1 75kAAC 4P 160A 2.2	Yes	Yes
LV433545	NSX250HB1 CIRCUIT BREAKER 2.2 250A 4P	C25V42D250	NSX250HB1 75kAAC 4P 250A 2.2	Yes	Yes
LV433308	NSX100HB1 CIRCUIT BREAKER 5.2 E	C10V45E040	NSX100HB1 75kAAC 4P 40A 5.2E	Yes	Yes
LV433310	NSX100HB1 CIRCUIT BREAKER 5.2 E	C10V45E100	NSX100HB1 75kAAC 4P 100A 5.2E	Yes	Yes
LV433549	NSX250HB1 CIRCUIT BREAKER 5.2 E 100A 4P	C25V45E100	NSX250HB1 75kAAC 4P 100A 5.2E	Yes	Yes
LV433551	NSX250HB1 CIRCUIT BREAKER 5.2 E 160A 4P	C25V45E160	NSX250HB1 75kAAC 4P 160A 5.2E	Yes	Yes
LV433553	NSX250HB1 CIRCUIT BREAKER 5.2 E 250A 4P	C25V45E250	NSX250HB1 75kAAC 4P 250A 5.2E	Yes	Yes
LV433312	NSX100HB1 CIRCUIT BREAKER 6.2 E	C10V46E040	NSX100HB1 75kAAC 4P 40A 6.2E	Yes	Yes
LV433314	NSX100HB1 CIRCUIT BREAKER 6.2 E	C10V46E100	NSX100HB1 75kAAC 4P 100A 6.2E	Yes	Yes
LV433555	NSX250HB1 CIRCUIT BREAKER 6.2 E 100A 4P	C25V46E100	NSX250HB1 75kAAC 4P 100A 6.2E	Yes	Yes
LV433557	NSX250HB1 CIRCUIT BREAKER 6.2 E 160A 4P	C25V46E160	NSX250HB1 75kAAC 4P 160A 6.2E	Yes	Yes
LV433559	NSX250HB1 CIRCUIT BREAKER 6.2 E 250A 4P	C25V46E250	NSX250HB1 75kAAC 4P 250A 6.2E	Yes	Yes
LV433248	NSX100HB1 CIRCUIT BREAKER MA	C10V3MA013	NSX100HB1 75kAAC 3P 12.5A MA	Yes	Yes
LV433249	NSX100HB1 CIRCUIT BREAKER MA	C10V3MA025	NSX100HB1 75kAAC 3P 25A MA	Yes	Yes
LV433250	NSX100HB1 CIRCUIT BREAKER MA	C10V3MA050	NSX100HB1 75kAAC 3P 50A MA	Yes	Yes
LV433251	NSX100HB1 CIRCUIT BREAKER MA	C10V3MA100	NSX100HB1 75kAAC 3P 100A MA	Yes	Yes
LV433502	NSX250HB1 CIRCUIT BREAKER MA	C25V3MA150	NSX250HB1 75kAAC 3P 150A MA	Yes	Yes
LV433503	NSX250HB1 CIRCUIT BREAKER MA	C25V3MA220	NSX250HB1 75kAAC 3P 220A MA	Yes	Yes
LV433304	NSX100HB1 CIRCUIT BREAKER 2.2 M	C10V32M025	NSX100HB1 75kAAC 3P 25A 2.2M	Yes	Yes
LV433305	NSX100HB1 CIRCUIT BREAKER 2.2 M	C10V32M050	NSX100HB1 75kAAC 3P 50A 2.2M	Yes	Yes

Compatibility of Components of Existing and New ComPacT NSX100/160/250

Old ComPacT NSX		New ComPacT NSX		Compatibility	
Cat. No	Description	Cat. No	Description	Old NSX to New Retrofit NSX	New Retrofit NSX to old NSX
LV433306	NSX100HB1 CIRCUIT BREAKER 2.2 M	C10V32M100	NSX100HB1 75kAAC 3P 100A 2.2M	Yes	Yes
LV433546	NSX250HB1 CIRCUIT BREAKER 2.2 M 150A 3P	C25V32M150	NSX250HB1 75kAAC 3P 150A 2.2M	Yes	Yes
LV433547	NSX250HB1 CIRCUIT BREAKER 2.2 M 220A 3P	C25V32M220	NSX250HB1 75kAAC 3P 220A 2.2M	Yes	Yes
LV433315	NSX100HB1 CIRCUIT BREAKER 6.2 EM	C10V36M025	NSX100HB1 75kAAC 3P 25A 6.2EM	Yes	Yes
LV433316	NSX100HB1 CIRCUIT BREAKER 6.2 EM	C10V36M050	NSX100HB1 75kAAC 3P 50A 6.2EM	Yes	Yes
LV433317	NSX100HB1 CIRCUIT BREAKER 6.2 EM	C10V36M080	NSX100HB1 75kAAC 3P 80A 6.2EM	Yes	Yes
LV433560	NSX250HB1 CIRCUIT BREAKER 6.2 EM 150A 3P	C25V36M150	NSX250HB1 75kAAC 3P 150A 6.2EM	Yes	Yes
LV433561	NSX250HB1 CIRCUIT BREAKER 6.2 EM 220A 3P	C25V36M220	NSX250HB1 75kAAC 3P 220A 6.2EM	Yes	Yes
LV433224	NSX100HB2 CIRCUIT BREAKER TMD	C10W3TM063	NSX100HB2 100kAAC 3P 63A TMD	Yes	Yes
LV433226	NSX100HB2 CIRCUIT BREAKER TMD	C10W3TM080	NSX100HB2 100kAAC 3P 80A TMD	Yes	Yes
LV433228	NSX100HB2 CIRCUIT BREAKER TMD	C10W3TM100	NSX100HB2 100kAAC 3P 100A TMD	Yes	Yes
LV433486	NSX250HB2 CIRCUIT BREAKER TMD	C25W3TM125	NSX250HB2 100kAAC 3P 125A TMD	Yes	Yes
LV433488	NSX250HB2 CIRCUIT BREAKER TMD	C25W3TM160	NSX250HB2 100kAAC 3P 160A TMD	Yes	Yes
LV433490	NSX250HB2 CIRCUIT BREAKER TMD	C25W3TM200	NSX250HB2 100kAAC 3P 200A TMD	Yes	Yes
LV433492	NSX250HB2 CIRCUIT BREAKER TMD	C25W3TM250	NSX250HB2 100kAAC 3P 250A TMD	Yes	Yes
LV433330	NSX100HB2 CIRCUIT BREAKER 2.2	C10W32D040	NSX100HB2 100kAAC 3P 40A 2.2	Yes	Yes
LV433332	NSX100HB2 CIRCUIT BREAKER 2.2	C10W32D100	NSX100HB2 100kAAC 3P 100A 2.2	Yes	Yes
LV433570	NSX250HB2 CIRCUIT BREAKER 2.2 100A 3P	C25W32D100	NSX250HB2 100kAAC 3P 100A 2.2	Yes	Yes
LV433572	NSX250HB2 CIRCUIT BREAKER 2.2 160A 3P	C25W32D160	NSX250HB2 100kAAC 3P 160A 2.2	Yes	Yes
LV433574	NSX250HB2 CIRCUIT BREAKER 2.2 250A 3P	C25W32D250	NSX250HB2 100kAAC 3P 250A 2.2	Yes	Yes
LV433337	NSX100HB2 CIRCUIT BREAKER 5.2 E	C10W35E040	NSX100HB2 100kAAC 3P 40A 5.2E	Yes	Yes
LV433339	NSX100HB2 CIRCUIT BREAKER 5.2 E	C10W35E100	NSX100HB2 100kAAC 3P 100A 5.2E	Yes	Yes
LV433578	NSX250HB2 CIRCUIT BREAKER 5.2 E	C25W35E100	NSX250HB2 100kAAC 3P 100A 5.2E	Yes	Yes
LV433580	NSX250HB2 CIRCUIT BREAKER 5.2 E	C25W35E160	NSX250HB2 100kAAC 3P 160A 5.2E	Yes	Yes
LV433582	NSX250HB2 CIRCUIT BREAKER 5.2 E	C25W35E250	NSX250HB2 100kAAC 3P 250A 5.2E	Yes	Yes
LV433225	NSX100HB2 CIRCUIT BREAKER TMD	C10W4TM063	NSX100HB2 100kAAC 4P 63A TMD	Yes	Yes
LV433227	NSX100HB2 CIRCUIT BREAKER TMD	C10W4TM080	NSX100HB2 100kAAC 4P 80A TMD	Yes	Yes
LV433229	NSX100HB2 CIRCUIT BREAKER TMD	C10W4TM100	NSX100HB2 100kAAC 4P 100A TMD	Yes	Yes
LV433487	NSX250HB2 CIRCUIT BREAKER TMD	C25W4TM125	NSX250HB2 100kAAC 4P 125A TMD	Yes	Yes
LV433489	NSX250HB2 CIRCUIT BREAKER TMD	C25W4TM160	NSX250HB2 100kAAC 4P 160A TMD	Yes	Yes
LV433491	NSX250HB2 CIRCUIT BREAKER TMD	C25W4TM200	NSX250HB2 100kAAC 4P 200A TMD	Yes	Yes
LV433493	NSX250HB2 CIRCUIT BREAKER TMD	C25W4TM250	NSX250HB2 100kAAC 4P 250A TMD	Yes	Yes
LV433331	NSX100HB2 CIRCUIT BREAKER 2.2	C10W42D040	NSX100HB2 100kAAC 4P 40A 2.2	Yes	Yes
LV433333	NSX100HB2 CIRCUIT BREAKER 2.2	C10W42D100	NSX100HB2 100kAAC 4P 100A 2.2	Yes	Yes
LV433571	NSX250HB2 CIRCUIT BREAKER 2.2 100A 4P	C25W42D100	NSX250HB2 100kAAC 4P 100A 2.2	Yes	Yes
LV433573	NSX250HB2 CIRCUIT BREAKER 2.2 160A 4P	C25W42D160	NSX250HB2 100kAAC 4P 160A 2.2	Yes	Yes
LV433575	NSX250HB2 CIRCUIT BREAKER 2.2 250A 4P	C25W42D250	NSX250HB2 100kAAC 4P 250A 2.2	Yes	Yes
LV433338	NSX100HB2 CIRCUIT BREAKER 5.2 E	C10W45E040	NSX100HB2 100kAAC 4P 40A 5.2E	Yes	Yes
LV433340	NSX100HB2 CIRCUIT BREAKER 5.2 E	C10W45E100	NSX100HB2 100kAAC 4P 100A 5.2E	Yes	Yes
LV433579	NSX250HB2 CIRCUIT BREAKER 5.2 E 100A 4P	C25W45E100	NSX250HB2 100kAAC 4P 100A 5.2E	Yes	Yes
LV433581	NSX250HB2 CIRCUIT BREAKER 5.2 E 160A 4P	C25W45E160	NSX250HB2 100kAAC 4P 160A 5.2E	Yes	Yes
LV433583	NSX250HB2 CIRCUIT BREAKER 5.2 E 250A 4P	C25W45E250	NSX250HB2 100kAAC 4P 250A 5.2E	Yes	Yes
LV433254	NSX100HB2 CIRCUIT BREAKER MA	C10W3MA013	NSX100HB2 100kAAC 3P 12.5A MA	Yes	Yes
LV433255	NSX100HB2 CIRCUIT BREAKER MA	C10W3MA025	NSX100HB2 100kAAC 3P 25A MA	Yes	Yes
LV433256	NSX100HB2 CIRCUIT BREAKER MA	C10W3MA050	NSX100HB2 100kAAC 3P 50A MA	Yes	Yes
LV433257	NSX100HB2 CIRCUIT BREAKER MA	C10W3MA100	NSX100HB2 100kAAC 3P 100A MA	Yes	Yes
LV433504	NSX250HB2 CIRCUIT BREAKER MA	C25W3MA150	NSX250HB2 100kAAC 3P 150A MA	Yes	Yes
LV433505	NSX250HB2 CIRCUIT BREAKER MA	C25W3MA220	NSX250HB2 100kAAC 3P 220A MA	Yes	Yes
LV433334	NSX100HB2 CIRCUIT BREAKER 2.2 M	C10W32M025	NSX100HB2 100kAAC 3P 25A 2.2M	Yes	Yes
LV433335	NSX100HB2 CIRCUIT BREAKER 2.2 M	C10W32M050	NSX100HB2 100kAAC 3P 50A 2.2M	Yes	Yes
LV433336	NSX100HB2 CIRCUIT BREAKER 2.2 M	C10W32M100	NSX100HB2 100kAAC 3P 100A 2.2M	Yes	Yes
LV433576	NSX250HB2 CIRCUIT BREAKER 2.2 M 150A 3P	C25W32M150	NSX250HB2 100kAAC 3P 150A 2.2M	Yes	Yes
LV433577	NSX250HB2 CIRCUIT BREAKER 2.2 M 220A 3P	C25W32M220	NSX250HB2 100kAAC 3P 220A 2.2M	Yes	Yes
LV433810	Breaker NSX100 3P 25k Micrologic 4.2 40	C10B34V040	NSX100B 25kAAC 3P3D 40A 4.2	Yes	Yes
LV433811	Breaker NSX100 3P 25k Micrologic 4.2 100	C10B34V100	NSX100B 25kAAC 3P3D 100A 4.2	Yes	Yes
LV433812	Breaker NSX160 3P 25k Micrologic 4.2 100	C16B34V100	NSX160B 25kAAC 3P3D 100A 4.2	Yes	Yes
LV433813	Breaker NSX160 3P 25k Micrologic 4.2 160	C16B34V160	NSX160B 25kAAC 3P3D 160A 4.2	Yes	Yes
LV433814	Breaker NSX250 3P 25k Micrologic 4.2 100	C25B34V100	NSX250B 25kAAC 3P3D 100A 4.2	Yes	Yes

Compatibility of Components of Existing and New ComPacT NSX100/160/250

Old ComPact NSX		New ComPacT NSX		Compatibility	
Cat. No	Description	Cat. No	Description	Old NSX to New Retrofit NSX	New Retrofit NSX to old NSX
LV433815	Breaker NSX250 3P 25k Micrologic 4.2 160	C25B34V160	NSX250B 25kAAC 3P3D 160A 4.2	Yes	Yes
LV433816	Breaker NSX250 3P 25k Micrologic 4.2 250	C25B34V250	NSX250B 25kAAC 3P3D 250A 4.2	Yes	Yes
LV433818	Breaker NSX100 4P 25k Micrologic 4.2 40	C10B44V040	NSX100B 25kAAC 4P4D 40A 4.2	Yes	Yes
LV433819	Breaker NSX100 4P 25k Micrologic 4.2 100	C10B44V100	NSX100B 25kAAC 4P4D 100A 4.2	Yes	Yes
LV433820	Breaker NSX160 4P 25k Micrologic 4.2 100	C16B44V100	NSX160B 25kAAC 4P4D 100A 4.2	Yes	Yes
LV433821	Breaker NSX160 4P 25k Micrologic 4.2 160	C16B44V160	NSX160B 25kAAC 4P4D 160A 4.2	Yes	Yes
LV433822	Breaker NSX250 4P 25k Micrologic 4.2 100	C25B44V100	NSX250B 25kAAC 4P4D 100A 4.2	Yes	Yes
LV433823	Breaker NSX250 4P 25k Micrologic 4.2 160	C25B44V160	NSX250B 25kAAC 4P4D 160A 4.2	Yes	Yes
LV433824	Breaker NSX250 4P 25k Micrologic 4.2 250	C25B44V250	NSX250B 25kAAC 4P4D 250A 4.2	Yes	Yes
LV433826	Breaker NSX100 3P 36k Micrologic 4.2 40	C10F34V040	NSX100F 36kAAC 3P3D 40A 4.2	Yes	Yes
LV433827	Breaker NSX100 3P 36k Micrologic 4.2 100	C10F34V100	NSX100F 36kAAC 3P3D 100A 4.2	Yes	Yes
LV433828	Breaker NSX160 3P 36k Micrologic 4.2 100	C16F34V100	NSX160F 36kAAC 3P3D 100A 4.2	Yes	Yes
LV433829	Breaker NSX160 3P 36k Micrologic 4.2 160	C16F34V160	NSX160F 36kAAC 3P3D 160A 4.2	Yes	Yes
LV433830	Breaker NSX250 3P 36k Micrologic 4.2 100	C25F34V100	NSX250F 36kAAC 3P3D 100A 4.2	Yes	Yes
LV433831	Breaker NSX250 3P 36k Micrologic 4.2 160	C25F34V160	NSX250F 36kAAC 3P3D 160A 4.2	Yes	Yes
LV433832	Breaker NSX250 3P 36k Micrologic 4.2 250	C25F34V250	NSX250F 36kAAC 3P3D 250A 4.2	Yes	Yes
LV433834	Breaker NSX100 4P 36k Micrologic 4.2 40	C10F44V040	NSX100F 36kAAC 4P4D 40A 4.2	Yes	Yes
LV433835	Breaker NSX100 4P 36k Micrologic 4.2 100	C10F44V100	NSX100F 36kAAC 4P4D 100A 4.2	Yes	Yes
LV433836	Breaker NSX160 4P 36k Micrologic 4.2 100	C16F44V100	NSX160F 36kAAC 4P4D 100A 4.2	Yes	Yes
LV433837	Breaker NSX160 4P 36k Micrologic 4.2 160	C16F44V160	NSX160F 36kAAC 4P4D 160A 4.2	Yes	Yes
LV433838	Breaker NSX250 4P 36k Micrologic 4.2 100	C25F44V100	NSX250F 36kAAC 4P4D 100A 4.2	Yes	Yes
LV433839	Breaker NSX250 4P 36k Micrologic 4.2 160	C25F44V160	NSX250F 36kAAC 4P4D 160A 4.2	Yes	Yes
LV433840	Breaker NSX250 4P 36k Micrologic 4.2 250	C25F44V250	NSX250F 36kAAC 4P4D 250A 4.2	Yes	Yes
LV433842	Breaker NSX100 3P 50k Micrologic 4.2 40	C10N34V040	NSX100N 50kAAC 3P3D 40A 4.2	Yes	Yes
LV433843	Breaker NSX100 3P 50k Micrologic 4.2 100	C10N34V100	NSX100N 50kAAC 3P3D 100A 4.2	Yes	Yes
LV433844	Breaker NSX160 3P 50k Micrologic 4.2 100	C16N34V100	NSX160N 50kAAC 3P3D 100A 4.2	Yes	Yes
LV433845	Breaker NSX160 3P 50k Micrologic 4.2 160	C16N34V160	NSX160N 50kAAC 3P3D 160A 4.2	Yes	Yes
LV433846	Breaker NSX250 3P 50k Micrologic 4.2 100	C25N34V100	NSX250N 50kAAC 3P3D 100A 4.2	Yes	Yes
LV433847	Breaker NSX250 3P 50k Micrologic 4.2 160	C25N34V160	NSX250N 50kAAC 3P3D 160A 4.2	Yes	Yes
LV433848	Breaker NSX250 3P 50k Micrologic 4.2 250	C25N34V250	NSX250N 50kAAC 3P3D 250A 4.2	Yes	Yes
LV433850	Breaker NSX100 4P 50k Micrologic 4.2 40	C10N44V040	NSX100N 50kAAC 4P4D 40A 4.2	Yes	Yes
LV433851	Breaker NSX100 4P 50k Micrologic 4.2 100	C10N44V100	NSX100N 50kAAC 4P4D 100A 4.2	Yes	Yes
LV433852	Breaker NSX160 4P 50k Micrologic 4.2 100	C16N44V100	NSX160N 50kAAC 4P4D 100A 4.2	Yes	Yes
LV433853	Breaker NSX160 4P 50k Micrologic 4.2 160	C16N44V160	NSX160N 50kAAC 4P4D 160A 4.2	Yes	Yes
LV433854	Breaker NSX250 4P 50k Micrologic 4.2 100	C25N44V100	NSX250N 50kAAC 4P4D 100A 4.2	Yes	Yes
LV433855	Breaker NSX250 4P 50k Micrologic 4.2 160	C25N44V160	NSX250N 50kAAC 4P4D 160A 4.2	Yes	Yes
LV433856	Breaker NSX250 4P 50k Micrologic 4.2 250	C25N44V250	NSX250N 50kAAC 4P4D 250A 4.2	Yes	Yes
LV433858	Breaker NSX100 3P 70k Micrologic 4.2 40	C10H34V040	NSX100H 70kAAC 3P3D 40A 4.2	Yes	Yes
LV433859	Breaker NSX100 3P 70k Micrologic 4.2 100	C10H34V100	NSX100H 70kAAC 3P3D 100A 4.2	Yes	Yes
LV433860	Breaker NSX160 3P 70k Micrologic 4.2 100	C16H34V100	NSX160H 70kAAC 3P3D 100A 4.2	Yes	Yes
LV433861	Breaker NSX160 3P 70k Micrologic 4.2 160	C16H34V160	NSX160H 70kAAC 3P3D 160A 4.2	Yes	Yes
LV433862	Breaker NSX250 3P 70k Micrologic 4.2 100	C25H34V100	NSX250H 70kAAC 3P3D 100A 4.2	Yes	Yes
LV433863	Breaker NSX250 3P 70k Micrologic 4.2 160	C25H34V160	NSX250H 70kAAC 3P3D 160A 4.2	Yes	Yes
LV433864	Breaker NSX250 3P 70k Micrologic 4.2 250	C25H34V250	NSX250H 70kAAC 3P3D 250A 4.2	Yes	Yes
LV433866	Breaker NSX100 4P 70k Micrologic 4.2 40	C10H44V040	NSX100H 70kAAC 4P4D 40A 4.2	Yes	Yes
LV433867	Breaker NSX100 4P 70k Micrologic 4.2 100	C10H44V100	NSX100H 70kAAC 4P4D 100A 4.2	Yes	Yes
LV433868	Breaker NSX160 4P 70k Micrologic 4.2 100	C16H44V100	NSX160H 70kAAC 4P4D 100A 4.2	Yes	Yes
LV433869	Breaker NSX160 4P 70k Micrologic 4.2 160	C16H44V160	NSX160H 70kAAC 4P4D 160A 4.2	Yes	Yes
LV433870	Breaker NSX250 4P 70k Micrologic 4.2 100	C25H44V100	NSX250H 70kAAC 4P4D 100A 4.2	Yes	Yes
LV433871	Breaker NSX250 4P 70k Micrologic 4.2 160	C25H44V160	NSX250H 70kAAC 4P4D 160A 4.2	Yes	Yes
LV433872	Breaker NSX250 4P 70k Micrologic 4.2 250	C25H44V250	NSX250H 70kAAC 4P4D 250A 4.2	Yes	Yes
LV433800	Micrologic 4.2 Vigi 3x40 for NSX100-250	C1034V040	TRIP UNIT NSX100 AC 3P3D 40A 4.2	Yes	Yes
LV433801	Micrologic 4.2 Vigi 3x100 for NSX100-250	C1034V100	TRIP UNIT NSX100 AC 3P3D 100A 4.2	Yes	Yes
LV433802	Micrologic 4.2 Vigi 3x160 for NSX160-250	C1634V160	TRIP UNIT NSX160 AC 3P3D 160A 4.2	Yes	Yes
LV433803	Micrologic 4.2 Vigi 3x250 for NSX250	C2534V250	TRIP UNIT NSX250 AC 3P3D 250A 4.2	Yes	Yes
LV433805	Micrologic 4.2 Vigi 4x40 for NSX100-250	C1044V040	TRIP UNIT NSX100 AC 4P4D 40A 4.2	Yes	Yes
LV433806	Micrologic 4.2 Vigi 4x100 for NSX100-250	C1044V100	TRIP UNIT NSX100 AC 4P4D 100A 4.2	Yes	Yes
LV433807	Micrologic 4.2 Vigi 4x160 for NSX160-250	C1644V160	TRIP UNIT NSX160 AC 4P4D 160A 4.2	Yes	Yes

Compatibility of Components of Existing and New ComPacT NSX100/160/250

Old ComPact NSX		New ComPact NSX		Compatibility	
Cat. No	Description	Cat. No	Description	Old NSX to New Retrofit NSX	New Retrofit NSX to old NSX
LV433808	Micrologic 4.2 Vigi 4x250 for NSX250	C2544V250	TRIP UNIT NSX250 AC 4P4D 250A 4.2	Yes	Yes
LV433879	Micrologic 7.2E Vigi 4x40 for NSX100-250	C1047E040	TRIP UNIT NSX100 AC 4P4D 40A 7.2E	Yes	Yes
LV433880	Micrologic 7.2E Vigi 4x100 for NSX100-250	C1047E100	TRIP UNIT NSX100 AC 4P4D 100A 7.2E	Yes	Yes
LV433881	Micrologic 7.2E Vigi 4x160 for NSX160-250	C1647E160	TRIP UNIT NSX160 AC 4P4D 160A 7.2E	Yes	Yes
LV433882	Micrologic 7.2 E Vigi 4x250 for NSX250	C2547E250	TRIP UNIT NSX250 AC 4P4D 250A 7.2E	Yes	Yes
LV433884	Micrologic 4.2 AL 3x40 for NSX100-250	C1034A040	TRIP UNIT NSX100 AC 3P3D 40A 4.2AL	Yes	Yes
LV433885	Micrologic 4.2 AL 3x100 for NSX100-250	C1034A100	TRIP UNIT NSX100 AC 3P3D 100A 4.2AL	Yes	Yes
LV433886	Micrologic 4.2 AL 3x160 for NSX160-250	C1634A160	TRIP UNIT NSX160 AC 3P3D 160A 4.2AL	Yes	Yes
LV433887	Micrologic 4.2 AL 3x250 for NSX250	C2534A250	TRIP UNIT NSX250 AC 3P3D 250A 4.2AL	Yes	Yes
LV433889	Micrologic 4.2 AL 4x40 for NSX100-250	C1044A040	TRIP UNIT NSX100 AC 4P4D 40A 4.2AL	Yes	Yes
LV433890	Micrologic 4.2 AL 4x100 for NSX100-250	C1044A100	TRIP UNIT NSX100 AC 4P4D 100A 4.2AL	Yes	Yes
LV433891	Micrologic 4.2 AL 4x160 for NSX160-250	C1644A160	TRIP UNIT NSX160 AC 4P4D 160A 4.2AL	Yes	Yes
LV433892	Micrologic 4.2 AL 4x250 for NSX250	C2544A250	TRIP UNIT NSX250 AC 4P4D 250A 4.2AL	Yes	Yes
LV433898	Micrologic 7.2 E AL 4x40 for NSX100-250	C1047A040	TRIP UNIT NSX100 AC 4P4D 40A 7.2E-AL	Yes	Yes
LV433899	Micrologic 7.2 E AL 4x100 for NSX100-250	C1047A100	TRIP UNIT NSX100 AC 4P4D 100A 7.2E-AL	Yes	Yes
LV433900	Micrologic 7.2 E AL 4x160 for NSX160-250	C1647A160	TRIP UNIT NSX160 AC 4P4D 160A 7.2E-AL	Yes	Yes
LV433901	Micrologic 7.2 E AL 4x250 for NSX250	C2547A250	TRIP UNIT NSX250 AC 4P4D 250A 7.2E-AL	Yes	Yes
LV433804	Micrologic 4.2 AB Vigi 4x100 for NSX	C1044B100	TRIP UNIT NSX100 AC 4P4D 100A 4.2AB	Yes	Yes
LV433809	Micrologic 4.2 AB Vigi 4x160 for NSX	C1644B160	TRIP UNIT NSX160 AC 4P4D 160A 4.2AB	Yes	Yes
LV433817	Micrologic 4.2 AB Vigi 4x240 for NSX250	C2544B250	TRIP UNIT NSX250 AC 4P4D 250A 4.2AB	Yes	Yes
LV434600	Breaker NSX250 4P 25k Micrologic 7.2 250	C25B47E250	NSX250B 25kAAC 4P4D 250A 7.2E	Yes	Yes
LV434601	Breaker NSX250 4P 25k Micrologic 7.2 160	C25B47E160	NSX250B 25kAAC 4P4D 160A 7.2E	Yes	Yes
LV434602	Breaker NSX250 4P 25k Micrologic 7.2 100	C25B47E100	NSX250B 25kAAC 4P4D 100A 7.2E	Yes	Yes
LV434603	Breaker NSX160 4P 25k Micrologic 7.2 160	C16B47E160	NSX160B 25kAAC 4P4D 160A 7.2E	Yes	Yes
LV434604	Breaker NSX160 4P 25k Micrologic 7.2 100	C16B47E100	NSX160B 25kAAC 4P4D 100A 7.2E	Yes	Yes
LV434605	Breaker NSX100 4P 25k Micrologic 7.2 100	C10B47E100	NSX100B 25kAAC 4P4D 100A 7.2E	Yes	Yes
LV434606	Breaker NSX100 4P 25k Micrologic 7.2 40	C10B47E040	NSX100B 25kAAC 4P4D 40A 7.2E	Yes	Yes
LV434607	Breaker NSX250 4P 36k Micrologic 7.2 250	C25F47E250	NSX250F 36kAAC 4P4D 250A 7.2E	Yes	Yes
LV434608	Breaker NSX250 4P 36k Micrologic 7.2 160	C25F47E160	NSX250F 36kAAC 4P4D 160A 7.2E	Yes	Yes
LV434609	Breaker NSX250 4P 36k Micrologic 7.2 100	C25F47E100	NSX250F 36kAAC 4P4D 100A 7.2E	Yes	Yes
LV434610	Breaker NSX160 4P 36k Micrologic 7.2 160	C16F47E160	NSX160F 36kAAC 4P4D 160A 7.2E	Yes	Yes
LV434611	Breaker NSX160 4P 36k Micrologic 7.2 100	C16F47E100	NSX160F 36kAAC 4P4D 100A 7.2E	Yes	Yes
LV434612	Breaker NSX100 4P 36k Micrologic 7.2 100	C10F47E100	NSX100F 36kAAC 4P4D 100A 7.2E	Yes	Yes
LV434613	Breaker NSX100 4P 36k Micrologic 7.2 40	C10F47E040	NSX100F 36kAAC 4P4D 40A 7.2E	Yes	Yes
LV434614	Breaker NSX250 4P 50k Micrologic 7.2 250	C25N47E250	NSX250N 50kAAC 4P4D 250A 7.2E	Yes	Yes
LV434615	Breaker NSX250 4P 50k Micrologic 7.2 160	C25N47E160	NSX250N 50kAAC 4P4D 160A 7.2E	Yes	Yes
LV434616	Breaker NSX250 4P 50k Micrologic 7.2 100	C25N47E100	NSX250N 50kAAC 4P4D 100A 7.2E	Yes	Yes
LV434617	Breaker NSX160 4P 50k Micrologic 7.2 160	C16N47E160	NSX160N 50kAAC 4P4D 160A 7.2E	Yes	Yes
LV434618	Breaker NSX160 4P 50k Micrologic 7.2 100	C16N47E100	NSX160N 50kAAC 4P4D 100A 7.2E	Yes	Yes
LV434619	Breaker NSX100 4P 50k Micrologic 7.2 100	C10N47E100	NSX100N 50kAAC 4P4D 100A 7.2E	Yes	Yes
LV434620	Breaker NSX100 4P 50k Micrologic 7.2 40	C10N47E040	NSX100N 50kAAC 4P4D 40A 7.2E	Yes	Yes
LV434621	Breaker NSX250 4P 70k Micrologic 7.2 250	C25H47E250	NSX250H 70kAAC 4P4D 250A 7.2E	Yes	Yes
LV434622	Breaker NSX250 4P 70k Micrologic 7.2 160	C25H47E160	NSX250H 70kAAC 4P4D 160A 7.2E	Yes	Yes
LV434623	Breaker NSX250 4P 70k Micrologic 7.2 100	C25H47E100	NSX250H 70kAAC 4P4D 100A 7.2E	Yes	Yes
LV434624	Breaker NSX160 4P 70k Micrologic 7.2 160	C16H47E160	NSX160H 70kAAC 4P4D 160A 7.2E	Yes	Yes
LV434625	Breaker NSX160 4P 70k Micrologic 7.2 100	C16H47E100	NSX160H 70kAAC 4P4D 100A 7.2E	Yes	Yes
LV434626	Breaker NSX100 4P 70k Micrologic 7.2 100	C10H47E100	NSX100H 70kAAC 4P4D 100A 7.2E	Yes	Yes
LV434627	Breaker NSX100 4P 70k Micrologic 7.2 40	C10H47E040	NSX100H 70kAAC 4P4D 40A 7.2E	Yes	Yes
LV433873	Breaker NSX100 4P 25kA Micrologic 4.2 AB Vigi 100	C10B44B100	NSX100B 25kAAC 4P4D 100A 4.2AB	Yes	Yes
LV433878	Breaker NSX160 4P 25kA Micrologic 4.2 AB Vigi 160	C16B44B160	NSX160B 25kAAC 4P4D 160A 4.2AB	Yes	Yes
LV433888	Breaker NSX250 4P 25kA Micrologic 4.2 AB Vigi 240	C25B44B240	NSX250B 25kAAC 4P4D 240A 4.2AB	Yes	Yes
LV433849	Breaker NSX100 4P 36kA Micrologic 4.2 AB Vigi 100	C10F44B100	NSX100F 36kAAC 4P4D 100A 4.2AB	Yes	Yes
LV433857	Breaker NSX160 4P 36kA Micrologic 4.2 AB Vigi 160	C16F44B160	NSX160F 36kAAC 4P4D 160A 4.2AB	Yes	Yes
LV433865	Breaker NSX250 4P 36kA Micrologic 4.2 AB Vigi 240	C25F44B240	NSX250F 36kAAC 4P4D 240A 4.2AB	Yes	Yes
LV438003	NSX100F DC 3P 36KA (FRAME W/O TRIP UNIT	C10F3D	BASIC FRAME NSX100F 36kA DC 3P 100A	Yes	Yes
LV438103	NSX160F DC 3P 36KA (FRAME W/O TRIP UNIT	C16F3D	BASIC FRAME NSX160F 36kA DC 3P 160A	Yes	Yes
LV438203	NSX250F DC 3P 36KA (FRAME W/O TRIP UNIT	C25F3D	BASIC FRAME NSX250F 36kA DC 3P 250A	Yes	Yes
LV438018	NSX100S DC 3P 100KA (FRAME W/O TRIP UNIT	C10S3D	BASIC FRAME NSX100S 100kA DC 3P 100A	Yes	Yes

Compatibility of Components of Existing and New ComPacT NSX100/160/250

Old ComPact NSX		New ComPacT NSX		Compatibility	
Cat. No	Description	Cat. No	Description	Old NSX to New Retrofit NSX	New Retrofit NSX to old NSX
LV438118	NSX160S DC 3P 100KA (FRAME W/O TRIP UNIT	C16S3D	BASIC FRAME NSX160S 100kA DC 3P 160A	Yes	Yes
LV438218	NSX250S DC 3P 100KA (FRAME W/O TRIP UNIT	C25S3D	BASIC FRAME NSX250S 100kA DC 3P 250A	Yes	Yes
LV438008	NSX100F DC 4P 36KA (FRAME W/O TRIP UNIT	C10F4D	BASIC FRAME NSX100F 36kA DC 4P 100A	Yes	Yes
LV438108	NSX160F DC 4P 36KA (FRAME W/O TRIP UNIT	C16F4D	BASIC FRAME NSX160F 36kA DC 4P 160A	Yes	Yes
LV438208	NSX250F DC 4P 36KA (FRAME W/O TRIP UNIT	C25F4D	BASIC FRAME NSX250F 36kA DC 4P 250A	Yes	Yes
LV438019	NSX100S DC 4P 100KA (FRAME W/O TRIP UNIT	C10S4D	BASIC FRAME NSX100S 100kA DC 4P 100A	Yes	Yes
LV438119	NSX160S DC 4P 100KA (FRAME W/O TRIP UNIT	C16S4D	BASIC FRAME NSX160S 100kA DC 4P 160A	Yes	Yes
LV438219	NSX250S DC 4P 100KA (FRAME W/O TRIP UNIT	C25S4D	BASIC FRAME NSX250S 100kA DC 4P 250A	Yes	Yes
LV438029	TM80DC 3P 3T DC TRIP UNIT	C103TM080D	TRIP UNIT NSX100 DC 3P 80A TMD	Yes	Yes
LV438028	DECL TM100DC 3P 3T DC TRIP UNIT	C103TM100D	TRIP UNIT NSX100 DC 3P 100A TMD	Yes	Yes
LV438136	TM125DC 3P 3T DC TRIP UNIT	C163TM125D	TRIP UNIT NSX160 DC 3P 125A TMD	Yes	Yes
LV438135	TM160DC 3P 3T DC TRIP UNIT	C163TM160D	TRIP UNIT NSX160 DC 3P 160A TMD	Yes	Yes
LV438246	TM200DC 3P 3T DC TRIP UNIT	C253TM200D	TRIP UNIT NSX250 DC 3P 200A TMD	Yes	Yes
LV438245	TM250DC 3P 3T DC TRIP UNIT	C253TM250D	TRIP UNIT NSX250 DC 3P 250A TMD	Yes	Yes
LV438049	TM80DC 4P 4T DC TRIP UNIT	C104TM080D	TRIP UNIT NSX100 DC 4P 80A TMD	Yes	Yes
LV438048	TM100DC 4P 4T DC TRIP UNIT	C104TM100D	TRIP UNIT NSX100 DC 4P 100A TMD	Yes	Yes
LV438146	TM125DC 4P 4T DC TRIP UNIT	C164TM125D	TRIP UNIT NSX160 DC 4P 125A TMD	Yes	Yes
LV438145	TM160DC 4P 4T DC TRIP UNIT	C164TM160D	TRIP UNIT NSX160 DC 4P 160A TMD	Yes	Yes
LV438256	TM200DC 4P 4T DC TRIP UNIT	C254TM200D	TRIP UNIT NSX250 DC 4P 200A TMD	Yes	Yes
LV438255	TM250DC 4P 4T DC TRIP UNIT	C254TM250D	TRIP UNIT NSX250 DC 4P 250A TMD	Yes	Yes
LV438081	CIRCUIT BREAKER COMPACT NSX80 TM DC PV 4	C10F4TM080D1	NSX100F 36kA DCPV 4P 80A TMD	Yes	Yes
LV438126	CIRCUIT BREAKER COMPACT NSX125 TM DC PV	C16F4TM125D1	NSX160F 36kA DCPV 4P 125A TMD	Yes	Yes
LV438100	SWITCH COMPACT NSX100 NA DC PV 4P	C104100D1S	SWITCH NSX100NA DCPV 4P 100A	Yes	Yes
LV438160	SWITCH COMPACT NSX160 NA DC PV 4P	C164160D1S	SWITCH NSX160NA DCPV 4P 160A	Yes	Yes
LV438250	SWITCH COMPACT NSX200 NA DC PV 4P	C254200D1S	SWITCH NSX250NA DCPV 4P 200A	Yes	Yes
LV433341	NSX100HB2 Mic6.2E 40 3P3D	C10W36E040	NSX100HB2 100kAAC 3P3D 40A 6.2E	Yes	Yes
LV433343	NSX100HB2 Mic6.2E 100 3P3D	C10W36E100	NSX100HB2 100kAAC 3P3D 100A 6.2E	Yes	Yes
LV433584	NSX250HB2 Mic6.2E 100 3P3D	C25W36E100	NSX250HB2 100kAAC 3P3D 100A 6.2E	Yes	Yes
LV433586	NSX250HB2 Mic6.2E 160 3P3D	C25W36E160	NSX250HB2 100kAAC 3P3D 160A 6.2E	Yes	Yes
LV433588	NSX250HB2 Mic6.2E 250 3P3D	C25W36E250	NSX250HB2 100kAAC 3P3D 250A 6.2E	Yes	Yes
LV433345	NSX100HB2 Mic6.2E-M 25 3P3D	C10W36M025	NSX100HB2 100kAAC 3P3D 25A 6.2EM	Yes	Yes
LV433346	NSX100HB2 Mic6.2E-M 50 3P3D	C10W36M050	NSX100HB2 100kAAC 3P3D 50A 6.2EM	Yes	Yes
LV433347	NSX100HB2 Mic6.2E-M 80 3P3D	C10W36M080	NSX100HB2 100kAAC 3P3D 80A 6.2EM	Yes	Yes
LV433590	NSX250HB2 Mic6.2E-M 150 3P3D	C25W36M150	NSX250HB2 100kAAC 3P3D 150A 6.2EM	Yes	Yes
LV433591	NSX250HB2 Mic6.2E-M 220 3P3D	C25W36M220	NSX250HB2 100kAAC 3P3D 220A 6.2EM	Yes	Yes
LV433342	NSX100HB2 Mic6.2E 40 4P4D	C10W46E040	NSX100HB2 100kAAC 4P4D 40A 6.2E	Yes	Yes
LV433344	NSX100HB2 Mic6.2E 100 4P4D	C10W46E100	NSX100HB2 100kAAC 4P4D 100A 6.2E	Yes	Yes
LV433585	NSX250HB2 Mic6.2E 100 4P4D	C25W46E100	NSX250HB2 100kAAC 4P4D 100A 6.2E	Yes	Yes
LV433587	NSX250HB2 Mic6.2E 160 4P4D	C25W46E160	NSX250HB2 100kAAC 4P4D 160A 6.2E	Yes	Yes
LV433589	NSX250HB2 Mic6.2E 250 4P4D	C25W46E250	NSX250HB2 100kAAC 4P4D 250A 6.2E	Yes	Yes

Compatibility of Components of Existing and New ComPacT NSX100/160/250

Old ComPact NSX		New ComPact NSX		Compatibility	
Cat. No	Description	Cat. No	Description	Old NSX to New Retrofit NSX	New Retrofit to Old NSX
LV435100	TRIP UNIT TM250D 3P3D 50°C FOR NSX250	C253TM250C	TRIP UNIT TM250D 3P3D 50°C FOR NSX250	Yes	Yes
LV435101	TRIP UNIT TM200D 3P3D 50°C FOR NSX250	C253TM200C	TRIP UNIT TM200D 3P3D 50°C FOR NSX250	Yes	Yes
LV435102	TRIP UNIT TM160D 3P3D 50°C FOR NSX160	C163TM160C	TRIP UNIT TM160D 3P3D 50°C FOR NSX160	Yes	Yes
LV435103	TRIP UNIT TM125D 3P3D 50°C NSX160-250	C163TM125C	TRIP UNIT TM125D 3P3D 50°C NSX160-250	Yes	Yes
LV435104	TRIP UNIT TM100D 3P3D 50°C FOR NSX100	C103TM100C	TRIP UNIT TM100D 3P3D 50°C FOR NSX100	Yes	Yes
LV435105	TRIP UNIT TM80D 3P3D 50°C FOR NSX100	C103TM080C	TRIP UNIT TM80D 3P3D 50°C FOR NSX100	Yes	Yes
LV435106	TRIP UNIT TM63D 3P3D 50°C FOR NSX100-250	C103TM063C	TRIP UNIT TM63D 3P3D 50°C FOR NSX100-250	Yes	Yes
LV435107	TRIP UNIT TM50D 3P3D 50°C FOR NSX100-250	C103TM050C	TRIP UNIT TM50D 3P3D 50°C FOR NSX100-250	Yes	Yes
LV435108	TRIP UNIT TM40D 3P3D 50°C FOR NSX100-250	C103TM040C	TRIP UNIT TM40D 3P3D 50°C FOR NSX100-250	Yes	Yes
LV435109	TRIP UNIT TM32D 3P3D 50°C FOR NSX100-250	C103TM032C	TRIP UNIT TM32D 3P3D 50°C FOR NSX100-250	Yes	Yes
LV435110	TRIP UNIT TM25D 3P3D 50°C FOR NSX100-250	C103TM025C	TRIP UNIT TM25D 3P3D 50°C FOR NSX100-250	Yes	Yes
LV435111	TRIP UNIT TM16D 3P3D 50°C FOR NSX100-250	C103TM016C	TRIP UNIT TM16D 3P3D 50°C FOR NSX100-250	Yes	Yes
LV435130	TRIP UNIT TM250D 4P3D 50°C FOR NSX250	C256TM250C	TRIP UNIT TM250D 4P3D 50°C FOR NSX250	Yes	Yes
LV435131	TRIP UNIT TM200D 4P3D 50°C FOR NSX250	C256TM200C	TRIP UNIT TM200D 4P3D 50°C FOR NSX250	Yes	Yes
LV435132	TRIP UNIT TM160D 4P3D 50°C FOR NSX160	C166TM160C	TRIP UNIT TM160D 4P3D 50°C FOR NSX160	Yes	Yes
LV435133	TRIP UNIT TM125D 4P3D 50°C NSX160-250	C166TM125C	TRIP UNIT TM125D 4P3D 50°C NSX160-250	Yes	Yes
LV435134	TRIP UNIT TM100D 4P3D 50°C FOR NSX100	C106TM100C	TRIP UNIT TM100D 4P3D 50°C FOR NSX100	Yes	Yes
LV435135	TRIP UNIT TM80D 4P3D 50°C FOR NSX100	C106TM080C	TRIP UNIT TM80D 4P3D 50°C FOR NSX100	Yes	Yes
LV435136	TRIP UNIT TM63D 4P3D 50°C FOR NSX100-250	C106TM063C	TRIP UNIT TM63D 4P3D 50°C FOR NSX100-250	Yes	Yes
LV435137	TRIP UNIT TM50D 4P3D 50°C FOR NSX100-250	C106TM050C	TRIP UNIT TM50D 4P3D 50°C FOR NSX100-250	Yes	Yes
LV435138	TRIP UNIT TM40D 4P3D 50°C FOR NSX100-250	C106TM040C	TRIP UNIT TM40D 4P3D 50°C FOR NSX100-250	Yes	Yes
LV435139	TRIP UNIT TM32D 4P3D 50°C FOR NSX100-250	C106TM032C	TRIP UNIT TM32D 4P3D 50°C FOR NSX100-250	Yes	Yes
LV435140	TRIP UNIT TM25D 4P3D 50°C FOR NSX100-250	C106TM025C	TRIP UNIT TM25D 4P3D 50°C FOR NSX100-250	Yes	Yes
LV435141	TRIP UNIT TM16D 4P3D 50°C FOR NSX100-250	C106TM016C	TRIP UNIT TM16D 4P3D 50°C FOR NSX100-250	Yes	Yes
LV435126	TRIP UNIT TM16D 4P3D 50°C FOR NSX100-250	C104TM016C	TRIP UNIT TM16D 4P4D 50°C FOR NSX100-250	Yes	Yes
LV435112	TRIP UNIT TM160D 3P3D 50°C FOR NSX250	C253TM160C	TRIP UNIT TM160D 3P3D 50°C FOR NSX250	Yes	Yes
LV435142	TRIP UNIT TM160D 4P3D 50°C FOR NSX250	C256TM160C	TRIP UNIT TM160D 4P3D 50°C FOR NSX250	Yes	Yes
LV435115	TRIP UNIT TM250D 4P4D 50°C FOR NSX250	C254TM250C	TRIP UNIT TM250D 4P4D 50°C FOR NSX250	Yes	Yes
LV435116	TRIP UNIT TM200D 4P4D 50°C FOR NSX250	C254TM200C	TRIP UNIT TM200D 4P4D 50°C FOR NSX250	Yes	Yes
LV435117	TRIP UNIT TM160D 4P4D 50°C FOR NSX160	C164TM160C	TRIP UNIT TM160D 4P4D 50°C FOR NSX160	Yes	Yes
LV435118	TRIP UNIT TM125D 4P4D 50°C NSX160-250	C164TM125C	TRIP UNIT TM125D 4P4D 50°C NSX160-250	Yes	Yes
LV435119	TRIP UNIT TM100D 4P4D 50°C FOR NSX100	C104TM100C	TRIP UNIT TM100D 4P4D 50°C FOR NSX100	Yes	Yes
LV435120	TRIP UNIT TM80D 4P4D 50°C FOR NSX100	C104TM080C	TRIP UNIT TM80D 4P4D 50°C FOR NSX100	Yes	Yes
LV435121	TRIP UNIT TM63D 4P4D 50°C FOR NSX100-250	C104TM063C	TRIP UNIT TM63D 4P4D 50°C FOR NSX100-250	Yes	Yes
LV435122	TRIP UNIT TM50D 4P4D 50°C FOR NSX100-250	C104TM050C	TRIP UNIT TM50D 4P4D 50°C FOR NSX100-250	Yes	Yes
LV435123	TRIP UNIT TM40D 4P4D 50°C FOR NSX100-250	C104TM040C	TRIP UNIT TM40D 4P4D 50°C FOR NSX100-250	Yes	Yes
LV435124	TRIP UNIT TM32D 4P4D 50°C FOR NSX100-250	C104TM032C	TRIP UNIT TM32D 4P4D 50°C FOR NSX100-250	Yes	Yes
LV435125	TRIP UNIT TM25D 4P4D 50°C FOR NSX100-250	C104TM025C	TRIP UNIT TM25D 4P4D 50°C FOR NSX100-250	Yes	Yes
LV435127	TRIP UNIT TM160D 4P4D FOR NSX250 50°C	C254TM160C	TRIP UNIT TM160D 4P4D FOR NSX250 50°C	Yes	Yes
LV430086	BREAKER NSX100F 16A 1P 36KA DC	C163MG125D	TRIP UNIT NSX160 DC 3P3D 125A TMG	Yes	Yes
LV430087	BREAKER NSX100F 16A 1P 36KA DC	C163MG160D	TRIP UNIT NSX160 DC 3P3D 160A TMG	Yes	Yes
LV430088	BREAKER NSX100F 16A 1P 36KA DC	C253MG200D	TRIP UNIT NSX250 DC 3P3D 200A TMG	Yes	Yes
LV430089	BREAKER NSX100F 16A 1P 36KA DC	C253MG250D	TRIP UNIT NSX250 DC 3P3D 250A TMG	Yes	Yes
LV430098	BREAKER NSX100F 16A 1P 36KA DC	C164MG125D	TRIP UNIT NSX160 DC 4P4D 125A TMG	Yes	Yes
LV430099	BREAKER NSX100F 16A 1P 36KA DC	C164MG160D	TRIP UNIT NSX160 DC 4P4D 160A TMG	Yes	Yes
LV430100	BREAKER NSX100F 16A 1P 36KA DC	C254MG200D	TRIP UNIT NSX250 DC 4P4D 200A TMG	Yes	Yes
LV430101	BREAKER NSX100F 16A 1P 36KA DC	C254MG250D	TRIP UNIT NSX250 DC 4P4D 250A TMG	Yes	Yes

Compatibility of Components of Existing and New ComPacT NSX400/630

Old ComPact NSX		New ComPacT NSX		Compatibility	
Cat. No	Description	Cat. No	Description	Old NSX to New Retrofit NSX	New Retrofit NSX to old NSX
LV432682	3P3T MICROLOGIC 2.3 250A NSX400F	C40F32D250	NSX400F 36kAAC 3P3D 250A 2.3	Yes	Yes
LV432676	3P3T MICROLOGIC 2.3 400A NSX400F	C40F32D400	NSX400F 36kAAC 3P3D 400A 2.3	Yes	Yes
LV432876	3P3T MICROLOGIC 2.3 630A NSX630F	C63F32D630	NSX630F 36kAAC 3P3D 630A 2.3	Yes	Yes
LV432748	3P3T MICROLOGIC 1.3 M 320A NSX400F	C40F31M320	NSX400F 36kAAC 3P3D 320A 1.3M	Yes	Yes
LV432948	3P3T MICROLOGIC 1.3 M 500A NSX630F	C63F31M500	NSX630F 36kAAC 3P3D 500A 1.3M	Yes	Yes
LV432775	3P3T MICROLOGIC 2.3 M 320A NSX400F	C40F32M320	NSX400F 36kAAC 3P3D 320A 2.3M	Yes	Yes
LV432975	3P3T MICROLOGIC 2.3 M 500A NSX630F	C63F32M500	NSX630F 36kAAC 3P3D 500A 2.3M	Yes	Yes
LV432683	4P4T MICROLOGIC 2.3 250A NSX400F	C40F42D250	NSX400F 36kAAC 4P4D 250A 2.3	Yes	Yes
LV432677	4P4T MICROLOGIC 2.3 400A NSX400F	C40F42D400	NSX400F 36kAAC 4P4D 400A 2.3	Yes	Yes
LV432877	4P4T MICROLOGIC 2.3 630A NSX630F	C63F42D630	NSX630F 36kAAC 4P4D 630A 2.3	Yes	Yes
LV432707	3P3T MICROLOGIC 2.3 250A NSX400N	C40N32D250	NSX400N 50kAAC 3P3D 250A 2.3	Yes	Yes
LV432693	3P3T MICROLOGIC 2.3 400A NSX400N	C40N32D400	NSX400N 50kAAC 3P3D 400A 2.3	Yes	Yes
LV432893	3P3T MICROLOGIC 2.3 630A NSX630N	C63N32D630	NSX630N 50kAAC 3P3D 630A 2.3	Yes	Yes
LV432749	3P3T MICROLOGIC 1.3 M 320A NSX400N	C40N31M320	NSX400N 50kAAC 3P3D 320A 1.3M	Yes	Yes
LV432949	3P3T MICROLOGIC 1.3 M 500A NSX630N	C63N31M500	NSX630N 50kAAC 3P3D 500A 1.3M	Yes	Yes
LV432776	3P3T MICROLOGIC 2.3 M 320A NSX400N	C40N32M320	NSX400N 50kAAC 3P3D 320A 2.3M	Yes	Yes
LV432976	3P3T MICROLOGIC 2.3 M 500A NSX630N	C63N32M500	NSX630N 50kAAC 3P3D 500A 2.3M	Yes	Yes
LV432708	4P4T MICROLOGIC 2.3 250A NSX400N	C40N42D250	NSX400N 50kAAC 4P4D 250A 2.3	Yes	Yes
LV432694	4P4T MICROLOGIC 2.3 400A NSX400N	C40N42D400	NSX400N 50kAAC 4P4D 400A 2.3	Yes	Yes
LV432894	4P4T MICROLOGIC 2.3 630A NSX630N	C63N42D630	NSX630N 50kAAC 4P4D 630A 2.3	Yes	Yes
LV432709	3P3T MICROLOGIC 2.3 250A NSX400H	C40H32D250	NSX400H 70kAAC 3P3D 250A 2.3	Yes	Yes
LV432695	3P3T MICROLOGIC 2.3 400A NSX400H	C40H32D400	NSX400H 70kAAC 3P3D 400A 2.3	Yes	Yes
LV432895	3P3T MICROLOGIC 2.3 630A NSX630H	C63H32D630	NSX630H 70kAAC 3P3D 630A 2.3	Yes	Yes
LV432750	3P3T MICROLOGIC 1.3 M 320A NSX400H	C40H31M320	NSX400H 70kAAC 3P3D 320A 1.3M	Yes	Yes
LV432950	3P3T MICROLOGIC 1.3 M 500A NSX630H	C63H31M500	NSX630H 70kAAC 3P3D 500A 1.3M	Yes	Yes
LV432777	3P3T MICROLOGIC 2.3 M 320A NSX400H	C40H32M320	NSX400H 70kAAC 3P3D 320A 2.3M	Yes	Yes
LV432977	3P3T MICROLOGIC 2.3 M 500A NSX630H	C63H32M500	NSX630H 70kAAC 3P3D 500A 2.3M	Yes	Yes
LV432710	4P4T MICROLOGIC 2.3 250A NSX400H	C40H42D250	NSX400H 70kAAC 4P4D 250A 2.3	Yes	Yes
LV432696	4P4T MICROLOGIC 2.3 400A NSX400H	C40H42D400	NSX400H 70kAAC 4P4D 400A 2.3	Yes	Yes
LV432896	4P4T MICROLOGIC 2.3 630A NSX630H	C63H42D630	NSX630H 70kAAC 4P4D 630A 2.3	Yes	Yes
		C40K32D250	NSX400K 10kAAC 3P3D 250A 2.3	New	
		C40K32D400	NSX400K 10kAAC 3P3D 400A 2.3	New	
		C40K42D250	NSX400K 10kAAC 4P4D 250A 2.3	New	
		C40K42D400	NSX400K 10kAAC 4P4D 400A 2.3	New	
LV432756	Compact NSX 400 3P NA	C403400S	SWITCH NSX400NAAC 3P3D 400A	Yes	Yes
LV432956	Compact NSX 630 3P NA SWITCH-DISCONNECTOR	C633630S	SWITCH NSX630NAAC 3P3D 630A	Yes	Yes
LV432757	Compact NSX 400 4P NA	C404400S	SWITCH NSX400NAAC 4P4D 400A	Yes	Yes
LV432957	Compact NSX 630 4P NA SWITCH-DISCONNECTOR	C634630S	SWITCH NSX630NAAC 4P4D 630A	Yes	Yes
LV432413	3P NSX400F WITHOUT TRIP UNIT	C40F3	BASIC FRAME NSX400F 36kAAC 3P 400A	Yes	Yes
LV432403	3P NSX400N WITHOUT TRIP UNIT COMPACT CI	C40N3	BASIC FRAME NSX400N 50kAAC 3P 400A	Yes	Yes
LV432404	3P NSX400H WITHOUT TRIP UNIT COMPACT CI	C40H3	BASIC FRAME NSX400H 70kAAC 3P 400A	Yes	Yes
LV432414	3P NSX400S WITHOUT TRIP UNIT COMPACT CI	C40S3	BASIC FRAME NSX400S 100kAAC 3P 400A	Yes	Yes
LV432405	3P NSX400L WITHOUT TRIP UNIT COMPACT CI	C40L3	BASIC FRAME NSX400L 150kAAC 3P 400A	Yes	Yes
LV432813	3P NSX630F WITHOUT TRIP UNIT COMPACT CI	C63F3	BASIC FRAME NSX630F 36kAAC 3P 630A	Yes	Yes
LV432803	3P NSX630N WITHOUT TRIP UNIT COMPACT CI	C63N3	BASIC FRAME NSX630N 50kAAC 3P 630A	Yes	Yes
LV432804	3P NSX630H WITHOUT TRIP UNIT COMPACT CI	C63H3	BASIC FRAME NSX630H 70kAAC 3P 630A	Yes	Yes
LV432814	3P NSX630S WITHOUT TRIP UNIT COMPACT CI	C63S3	BASIC FRAME NSX630S 100kAAC 3P 630A	Yes	Yes
LV432805	3P NSX630L WITHOUT TRIP UNIT COMPACT CI	C63L3	BASIC FRAME NSX630L 150kAAC 3P 630A	Yes	Yes
LV432082	3P3T MICROLOGIC 2.3 250A TRIP UNIT	C4032D250	TRIP UNIT NSX400 AC 3P3D 250A 2.3	Yes	Yes
LV432081	3P3T MICROLOGIC 2.3 400A TRIP UNIT	C4032D400	TRIP UNIT NSX400 AC 3P3D 400A 2.3	Yes	Yes
LV432080	3P3T MICROLOGIC 2.3 630A TRIP UNIT	C6332D630	TRIP UNIT NSX630 AC 3P3D 630A 2.3	Yes	Yes
LV432097	3P3T MICROLOGIC 5.3 E 400A TRIP UNIT	C4035E400	TRIP UNIT NSX400 AC 3P3D 400A 5.3E	Yes	Yes
LV432096	3P3T MICROLOGIC 5.3 E 630A TRIP UNIT	C6335E630	TRIP UNIT NSX630 AC 3P3D 630A 5.3E	Yes	Yes
LV432109	3P3T MICROLOGIC 6.3 E 400A TRIP UNIT	C4036E400	TRIP UNIT NSX400 AC 3P3D 400A 6.3E	Yes	Yes
LV432108	3P3T MICROLOGIC 6.3 E 630A TRIP UNIT	C6336E630	TRIP UNIT NSX630 AC 3P3D 630A 6.3E	Yes	Yes
LV432069	3P3T MICROLOGIC 1.3 M 320A TRIP UNIT	C4031M320	TRIP UNIT NSX400 AC 3P3D 320A 1.3M	Yes	Yes
LV432068	3P3T MICROLOGIC 1.3 M 500A TRIP UNIT	C6331M500	TRIP UNIT NSX630 AC 3P3D 500A 1.3M	Yes	Yes
LV432072	3P3T MICROLOGIC 2.3 M 320A TRIP UNIT	C4032M320	TRIP UNIT NSX400 AC 3P3D 320A 2.3M	Yes	Yes

Compatibility of Components of Existing and New ComPacT NSX400/630

Old ComPacT NSX		New ComPacT NSX		Compatibility	
Cat. No	Description	Cat. No	Description	Old NSX to New Retrofit NSX	New Retrofit NSX to old NSX
LV432071	3P3T MICROLOGIC 2.3 M 500A TRIP UNIT	C6332M500	TRIP UNIT NSX630 AC 3P3D 500A 2.3M	Yes	Yes
LV432075	3P3T MICROLOGIC 6.3 E-M 320A TRIP UNIT	C4036M320	TRIP UNIT NSX400 AC 3P3D 320A 6.3EM	Yes	Yes
LV432074	3P3T MICROLOGIC 6.3 E-M 500A TRIP UNIT	C6336M500	TRIP UNIT NSX630 AC 3P3D 500A 6.3EM	Yes	Yes
LV432089	3P3T MICROLOGIC 5.3 A-Z 630A TRIP UNIT	C6335Z630	TRIP UNIT NSX630 AC 3P3D 630A 5.3AZ	Yes	Yes
LV432415	4P NSX400F WITHOUT TRIP UNIT	C40F4	BASIC FRAME NSX400F 36kAAC 4P 400A	Yes	Yes
LV432408	4P NSX400N WITHOUT TRIP UNIT COMPACT CI	C40N4	BASIC FRAME NSX400N 50kAAC 4P 400A	Yes	Yes
LV432409	4P NSX400H WITHOUT TRIP UNIT COMPACT CI	C40H4	BASIC FRAME NSX400H 70kAAC 4P 400A	Yes	Yes
LV432416	4P NSX400S WITHOUT TRIP UNIT COMPACT CI	C40S4	BASIC FRAME NSX400S 100kAAC 4P 400A	Yes	Yes
LV432410	4P NSX400L WITHOUT TRIP UNIT COMPACT CI	C40L4	BASIC FRAME NSX400L 150kAAC 4P 400A	Yes	Yes
LV432815	4P NSX630F WITHOUT TRIP UNIT COMPACT CI	C63F4	BASIC FRAME NSX630F 36kAAC 4P 630A	Yes	Yes
LV432808	4P NSX630N WITHOUT TRIP UNIT COMPACT CI	C63N4	BASIC FRAME NSX630N 50kAAC 4P 630A	Yes	Yes
LV432809	4P NSX630H WITHOUT TRIP UNIT COMPACT CI	C63H4	BASIC FRAME NSX630H 70kAAC 4P 630A	Yes	Yes
LV432816	4P NSX630S WITHOUT TRIP UNIT COMPACT CI	C63S4	BASIC FRAME NSX630S 100kAAC 4P 630A	Yes	Yes
LV432810	4P NSX630L WITHOUT TRIP UNIT COMPACT CI	C63L4	BASIC FRAME NSX630L 150kAAC 4P 630A	Yes	Yes
LV432086	4P4T MICROLOGIC 2.3 250A TRIP UNIT	C4042D250	TRIP UNIT NSX400 AC 4P4D 250A 2.3	Yes	Yes
LV432085	4P4T MICROLOGIC 2.3 400A TRIP UNIT	C4042D400	TRIP UNIT NSX400 AC 4P4D 400A 2.3	Yes	Yes
LV432084	4P4T MICROLOGIC 2.3 630A TRIP UNIT	C6342D630	TRIP UNIT NSX630 AC 4P4D 630A 2.3	Yes	Yes
LV432100	4P4T MICROLOGIC 5.3 E 400A TRIP UNIT	C4045E400	TRIP UNIT NSX400 AC 4P4D 400A 5.3E	Yes	Yes
LV432099	4P4T MICROLOGIC 5.3 E 630A TRIP UNIT	C6345E630	TRIP UNIT NSX630 AC 4P4D 630A 5.3E	Yes	Yes
LV432112	4P4T MICROLOGIC 6.3 E 400A TRIP UNIT	C4046E400	TRIP UNIT NSX400 AC 4P4D 400A 6.3E	Yes	Yes
LV432111	4P4T MICROLOGIC 6.3 E 630A TRIP UNIT	C6346E630	TRIP UNIT NSX630 AC 4P4D 630A 6.3E	Yes	Yes
LV432078	4P3T MICROLOGIC 1.3 M 320A TRIP UNIT	C4041M320	TRIP UNIT NSX400 AC 4P4D 320A 1.3M	Yes	Yes
LV432077	4P3T MICROLOGIC 1.3 M 500A TRIP UNIT	C6341M500	TRIP UNIT NSX630 AC 4P4D 500A 1.3M	Yes	Yes
LV434557	4P4T MICROLOGIC 2.3 AB 400A TRIP UNIT	C4042B400	TRIP UNIT NSX400 AC 4P4D 400A 2.3AB	Yes	Yes
LV433600	NSX400R CIRCUIT BREAKER 2.3 250A 3P	C40R32D250	NSX400R 200kAAC 3P 250A 2.3	Yes	Yes
LV433602	NSX400R CIRCUIT BREAKER 2.3 400A 3P	C40R32D400	NSX400R 200kAAC 3P 400A 2.3	Yes	Yes
LV433700	NSX630R CIRCUIT BREAKER 2.3 630A 3P	C63R32D630	NSX630R 200kAAC 3P 630A 2.3	Yes	Yes
LV433606	NSX400R CIRCUIT BREAKER 5.3 E	C40R35E400	NSX400R 200kAAC 3P 400A 5.3E	Yes	Yes
LV433704	NSX630R CIRCUIT BREAKER 5.3 E 630A 3P	C63R35E630	NSX630R 200kAAC 3P 630A 5.3E	Yes	Yes
LV433608	NSX400R CIRCUIT BREAKER 6.3 E 400A 3P	C40R36E400	NSX400R 200kAAC 3P 400A 6.3E	Yes	Yes
LV433706	NSX630R CIRCUIT BREAKER 6.3 E 630A 3P	C63R36E630	NSX630R 200kAAC 3P 630A 6.3E	Yes	Yes
LV433604	NSX400R CIRCUIT BREAKER 1.3 MA 320A 3P	C40R31M320	NSX400R 200kAAC 3P 320A 1.3M	Yes	Yes
LV433702	NSX630R CIRCUIT BREAKER 1.3 MA 500A 3P	C63R31M500	NSX630R 200kAAC 3P 500A 1.3M	Yes	Yes
LV433605	NSX400R CIRCUIT BREAKER 2.3 M 320A 3P	C40R32M320	NSX400R 200kAAC 3P 320A 2.3M	Yes	Yes
LV433703	NSX630R CIRCUIT BREAKER 2.3 M 500A 3P	C63R32M500	NSX630R 200kAAC 3P 500A 2.3M	Yes	Yes
LV433610	NSX400R CIRCUIT BREAKER 6.3 EM 320A 3P	C40R36M320	NSX400R 200kAAC 3P 320A 6.3EM	Yes	Yes
LV433708	NSX630R CIRCUIT BREAKER 6.3 EM 500A 3P	C63R36M500	NSX630R 200kAAC 3P 500A 6.3EM	Yes	Yes
LV433601	NSX400R CIRCUIT BREAKER 2.3 250A 4P	C40R42D250	NSX400R 200kAAC 4P 250A 2.3	Yes	Yes
LV433603	NSX400R CIRCUIT BREAKER 2.3 400A 4P	C40R42D400	NSX400R 200kAAC 4P 400A 2.3	Yes	Yes
LV433701	NSX630R CIRCUIT BREAKER 2.3 630A 4P	C63R42D630	NSX630R 200kAAC 4P 630A 2.3	Yes	Yes
LV433607	NSX400R CIRCUIT BREAKER 5.3 E 400A 4P	C40R45E400	NSX400R 200kAAC 4P 400A 5.3E	Yes	Yes
LV433705	NSX630R CIRCUIT BREAKER 5.3 E 630A 4P	C63R45E630	NSX630R 200kAAC 4P 630A 5.3E	Yes	Yes
LV433609	NSX400R CIRCUIT BREAKER 6.3 E 400A 4P	C40R46E400	NSX400R 200kAAC 4P 400A 6.3E	Yes	Yes
LV433707	NSX630R CIRCUIT BREAKER 6.3 E 630A 4P	C63R46E630	NSX630R 200kAAC 4P 630A 6.3E	Yes	Yes
LV433620	NSX400HB1 CIRCUIT BREAKER 2.3 250A 3P	C40V32D250	NSX400HB1 75kAAC 3P 250A 2.3	Yes	Yes
LV433622	NSX400HB1 CIRCUIT BREAKER 2.3 400A 3P	C40V32D400	NSX400HB1 75kAAC 3P 400A 2.3	Yes	Yes
LV433720	NSX630HB1 CIRCUIT BREAKER 2.3 630A 3P	C63V32D630	NSX630HB1 75kAAC 3P 630A 2.3	Yes	Yes
LV433626	NSX400HB1 CIRCUIT BREAKER 5.3 E	C40V35E400	NSX400HB1 75kAAC 3P 400A 5.3E	Yes	Yes
LV433724	NSX630HB1 CIRCUIT BREAKER 5.3 E 630A 3P	C63V35E630	NSX630HB1 75kAAC 3P 630A 5.3E	Yes	Yes
LV433628	NSX400HB1 CIRCUIT BREAKER 6.3 E 400A 3P	C40V36E400	NSX400HB1 75kAAC 3P 400A 6.3E	Yes	Yes
LV433726	NSX630HB1 CIRCUIT BREAKER 6.3 E 630A 3P	C63V36E630	NSX630HB1 75kAAC 3P 630A 6.3E	Yes	Yes
LV433624	NSX400HB1 CIRCUIT BREAKER 1.3 MA 320A 3P	C40V31M320	NSX400HB1 75kAAC 3P 320A 1.3M	Yes	Yes
LV433722	NSX630HB1 CIRCUIT BREAKER 1.3 MA 500A 3P	C63V31M500	NSX630HB1 75kAAC 3P 500A 1.3M	Yes	Yes
LV433625	NSX400HB1 CIRCUIT BREAKER 2.3 M 320A 3P	C40V32M320	NSX400HB1 75kAAC 3P 320A 2.3M	Yes	Yes
LV433723	NSX630HB1 CIRCUIT BREAKER 2.3 M 500A 3P	C63V32M500	NSX630HB1 75kAAC 3P 500A 2.3M	Yes	Yes
LV433630	NSX400HB1 CIRCUIT BREAKER 6.3 EM 320A 3P	C40V36M320	NSX400HB1 75kAAC 3P 320A 6.3EM	Yes	Yes
LV433728	NSX630HB1 CIRCUIT BREAKER 6.3 EM 500A 3P	C63V36M500	NSX630HB1 75kAAC 3P 500A 6.3EM	Yes	Yes
LV433621	NSX400HB1 CIRCUIT BREAKER 2.3 250A 4P	C40V42D250	NSX400HB1 75kAAC 4P 250A 2.3	Yes	Yes

Compatibility of Components of Existing and New ComPacT NSX400/630

Old ComPact NSX		New ComPacT NSX		Compatibility	
Cat. No	Description	Cat. No	Description	Old NSX to New Retrofit NSX	New Retrofit NSX to old NSX
LV433623	NSX400HB1 CIRCUIT BREAKER 2.3 400A 4P	C40V42D400	NSX400HB1 75kAAC 4P 400A 2.3	Yes	Yes
LV433721	NSX630HB1 CIRCUIT BREAKER 2.3 630A 4P	C63V42D630	NSX630HB1 75kAAC 4P 630A 2.3	Yes	Yes
LV433627	NSX400HB1 CIRCUIT BREAKER 5.3 E 400A 4P	C40V45E400	NSX400HB1 75kAAC 4P 400A 5.3E	Yes	Yes
LV433725	NSX630HB1 CIRCUIT BREAKER 5.3 E 630A 4P	C63V45E630	NSX630HB1 75kAAC 4P 630A 5.3E	Yes	Yes
LV433629	NSX400HB1 CIRCUIT BREAKER 6.3 E 400A 4P	C40V46E400	NSX400HB1 75kAAC 4P 400A 6.3E	Yes	Yes
LV433727	NSX630HB1 CIRCUIT BREAKER 6.3 E 630A 4P	C63V46E630	NSX630HB1 75kAAC 4P 630A 6.3E	Yes	Yes
LV433640	NSX400HB2 CIRCUIT BREAKER 2.3 250A 3P	C40W32D250	NSX400HB2 100kAAC 3P 250A 2.3	Yes	Yes
LV433642	NSX400HB2 CIRCUIT BREAKER 2.3 400A 3P	C40W32D400	NSX400HB2 100kAAC 3P 400A 2.3	Yes	Yes
LV433740	NSX630HB2 CIRCUIT BREAKER 2.3 630A 3P	C63W32D630	NSX630HB2 100kAAC 3P 630A 2.3	Yes	Yes
LV433646	NSX400HB2 CIRCUIT BREAKER 5.3 E 400A 3P	C40W35E400	NSX400HB2 100kAAC 3P 400A 5.3E	Yes	Yes
LV433744	NSX630HB2 CIRCUIT BREAKER 5.3 E 630A 3P	C63W35E630	NSX630HB2 100kAAC 3P 630A 5.3E	Yes	Yes
LV433648	NSX400HB2 CIRCUIT BREAKER 6.3 E 400A 3P	C40W36E400	NSX400HB2 100kAAC 3P 400A 6.3E	Yes	Yes
LV433746	NSX630HB2 CIRCUIT BREAKER 6.3 E 630A 3P	C63W36E630	NSX630HB2 100kAAC 3P 630A 6.3E	Yes	Yes
LV433644	NSX400HB2 CIRCUIT BREAKER 1.3 MA 320A 3P	C40W31M320	NSX400HB2 100kAAC 3P 320A 1.3M	Yes	Yes
LV433742	NSX630HB2 CIRCUIT BREAKER 1.3 MA 500A 3P	C63W31M500	NSX630HB2 100kAAC 3P 500A 1.3M	Yes	Yes
LV433645	NSX400HB2 CIRCUIT BREAKER 2.3 M 320A 3P	C40W32M320	NSX400HB2 100kAAC 3P 320A 2.3M	Yes	Yes
LV433743	NSX630HB2 CIRCUIT BREAKER 2.3 M 500A 3P	C63W32M500	NSX630HB2 100kAAC 3P 500A 2.3M	Yes	Yes
LV433650	NSX400HB2 CIRCUIT BREAKER 6.3 EM 320A 3P	C40W36M320	NSX400HB2 100kAAC 3P 320A 6.3EM	Yes	Yes
LV433748	NSX630HB2 CIRCUIT BREAKER 6.3 EM 500A 3P	C63W36M500	NSX630HB2 100kAAC 3P 500A 6.3EM	Yes	Yes
LV433641	NSX400HB2 CIRCUIT BREAKER 2.3 250A 4P	C40W42D250	NSX400HB2 100kAAC 4P 250A 2.3	Yes	Yes
LV433643	NSX400HB2 CIRCUIT BREAKER 2.3 400A 4P	C40W42D400	NSX400HB2 100kAAC 4P 400A 2.3	Yes	Yes
LV433741	NSX630HB2 CIRCUIT BREAKER 2.3 630A 4P	C63W42D630	NSX630HB2 100kAAC 4P 630A 2.3	Yes	Yes
LV433647	NSX400HB2 CIRCUIT BREAKER 5.3 E 400A 4P	C40W45E400	NSX400HB2 100kAAC 4P 400A 5.3E	Yes	Yes
LV433745	NSX630HB2 CIRCUIT BREAKER 5.3 E 630A 4P	C63W45E630	NSX630HB2 100kAAC 4P 630A 5.3E	Yes	Yes
LV433649	NSX400HB2 CIRCUIT BREAKER 6.3 E 400A 4P	C40W46E400	NSX400HB2 100kAAC 4P 400A 6.3E	Yes	Yes
LV433747	NSX630HB2 CIRCUIT BREAKER 6.3 E 630A 4P	C63W46E630	NSX630HB2 100kAAC 4P 630A 6.3E	Yes	Yes
LV433934	Breaker NSX400 3P 36k Micrologic 4.3 400	C40F34V400	NSX400F 36kAAC 3P3D 400A 4.3	Yes	Yes
LV433935	Breaker NSX630 3P 36k Micrologic 4.3 570	C63F34V570	NSX630F 36kAAC 3P3D 570A 4.3	Yes	Yes
LV433936	Breaker NSX400 4P 36k Micrologic 4.3 400	C40F44V400	NSX400F 36kAAC 4P4D 400A 4.3	Yes	Yes
LV433937	Breaker NSX630 4P 36k Micrologic 4.3 570	C63F44V570	NSX630F 36kAAC 4P4D 570A 4.3	Yes	Yes
LV433938	Breaker NSX400 3P 50k Micrologic 4.3 400	C40N34V400	NSX400N 50kAAC 3P3D 400A 4.3	Yes	Yes
LV433939	Breaker NSX630 3P 50k Micrologic 4.3 570	C63N34V570	NSX630N 50kAAC 3P3D 570A 4.3	Yes	Yes
LV433940	Breaker NSX400 4P 50k Micrologic 4.3 400	C40N44V400	NSX400N 50kAAC 4P4D 400A 4.3	Yes	Yes
LV433941	Breaker NSX630 4P 50k Micrologic 4.3 570	C63N44V570	NSX630N 50kAAC 4P4D 570A 4.3	Yes	Yes
LV433942	Breaker NSX400 3P 70k Micrologic 4.3 400	C40H34V400	NSX400H 70kAAC 3P3D 400A 4.3	Yes	Yes
LV433943	Breaker NSX630 3P 70k Micrologic 4.3 570	C63H34V570	NSX630H 70kAAC 3P3D 570A 4.3	Yes	Yes
LV433944	Breaker NSX400 4P 70k Micrologic 4.3 400	C40H44V400	NSX400H 70kAAC 4P4D 400A 4.3	Yes	Yes
LV433945	Breaker NSX630 4P 70k Micrologic 4.3 570	C63H44V570	NSX630H 70kAAC 4P4D 570A 4.3	Yes	Yes
LV433949	Breaker NSX400 4P 36kA Micrologic 4.3 AB Vigi 400	C40F44B400	NSX400F 36kAAC 4P4D 400A 4.3AB	Yes	Yes
LV433948	Micrologic 4.3 AB Vigi 4P 400A for NSX400-630	C4044B400	TRIP UNIT NSX400 AC 4P4D 400A 4.3AB	Yes	Yes
LV433930	Micrologic 4.3 Vigi 3x400 for NSX400-630	C4034V400	TRIP UNIT NSX400 AC 3P3D 400A 4.3	Yes	Yes
LV433931	Micrologic 4.3 Vigi 3x570 for NSX630	C6334V570	TRIP UNIT NSX630 AC 3P3D 570A 4.3	Yes	Yes
LV433932	Micrologic 4.3 Vigi 4x400 for NSX400-630	C4044V400	TRIP UNIT NSX400 AC 4P4D 400A 4.3	Yes	Yes
LV433933	Micrologic 4.3 Vigi 4x570 for NSX630	C6344V570	TRIP UNIT NSX630 AC 4P4D 570A 4.3	Yes	Yes
LV433950	Micrologic 7.3E Vigi 3x400 for NSX400-630	C4037E400	TRIP UNIT NSX400 AC 3P3D 400A 7.3E	Yes	Yes
LV433951	Micrologic 7.3E Vigi 3x570 for NSX630	C6337E570	TRIP UNIT NSX630 AC 3P3D 570A 7.3E	Yes	Yes
LV433952	Micrologic 7.3E Vigi 4x400 for NSX400-630	C4047E400	TRIP UNIT NSX400 AC 4P4D 400A 7.3E	Yes	Yes
LV433953	Micrologic 7.3E Vigi 4x570 for NSX630	C6347E570	TRIP UNIT NSX630 AC 4P4D 570A 7.3E	Yes	Yes
LV433960	Micrologic 4.3 AL 3x400 for NSX400-630	C4034A400	TRIP UNIT NSX400 AC 3P3D 400A 4.3AL	Yes	Yes
LV433961	Micrologic 4.3 AL 3x570 for NSX630	C6334A570	TRIP UNIT NSX630 AC 3P3D 570A 4.3AL	Yes	Yes
LV433962	Micrologic 4.3 AL 4x400 for NSX400-630	C4044A400	TRIP UNIT NSX400 AC 4P4D 400A 4.3AL	Yes	Yes
LV433963	Micrologic 4.3 AL 4x570 for NSX630	C6344A570	TRIP UNIT NSX630 AC 4P4D 570A 4.3AL	Yes	Yes
LV433965	Micrologic 7.3 E AL 3x400 for NSX400-630	C4037A400	TRIP UNIT NSX400 AC 3P3D 400A 7.3E-AL	Yes	Yes
LV433966	Micrologic 7.3 E AL 3x570 for NSX630	C6337A570	TRIP UNIT NSX630 AC 3P3D 570A 7.3E-AL	Yes	Yes
LV433967	Micrologic 7.3 E AL 4x400 for NSX400-630	C4047A400	TRIP UNIT NSX400 AC 4P4D 400A 7.3E-AL	Yes	Yes
LV433968	Micrologic 7.3 E AL 4x570 for NSX630	C6347A570	TRIP UNIT NSX630 AC 4P4D 570A 7.3E-AL	Yes	Yes
LV434630	Breaker NSX630 3P 36k Micrologic 7.3 570	C63F37E570	NSX630F 36kAAC 3P3D 570A 7.3E	Yes	Yes
LV434631	Breaker NSX400 3P 36k Micrologic 7.3 400	C40F37E400	NSX400F 36kAAC 3P3D 400A 7.3E	Yes	Yes

Compatibility of Components of Existing and New ComPacT NSX400/630

Old ComPact NSX		New ComPact NSX		Compatibility	
Cat. No	Description	Cat. No	Description	Old NSX to New Retrofit NSX	New Retrofit NSX to old NSX
LV434632	Breaker NSX630 4P 36k Micrologic 7.3 570	C63F47E570	NSX630F 36kAAC 4P4D 570A 7.3E	Yes	Yes
LV434633	Breaker NSX400 4P 36k Micrologic 7.3 400	C40F47E400	NSX400F 36kAAC 4P4D 400A 7.3E	Yes	Yes
LV434634	Breaker NSX630 3P 50k Micrologic 7.3 570	C63N37E570	NSX630N 50kAAC 3P3D 570A 7.3E	Yes	Yes
LV434635	Breaker NSX400 3P 50k Micrologic 7.3 400	C40N37E400	NSX400N 50kAAC 3P3D 400A 7.3E	Yes	Yes
LV434636	Breaker NSX630 4P 50k Micrologic 7.3 570	C63N47E570	NSX630N 50kAAC 4P4D 570A 7.3E	Yes	Yes
LV434637	Breaker NSX400 4P 50k Micrologic 7.3 400	C40N47E400	NSX400N 50kAAC 4P4D 400A 7.3E	Yes	Yes
LV434638	Breaker NSX630 3P 70k Micrologic 7.3 570	C63H37E570	NSX630H 70kAAC 3P3D 570A 7.3E	Yes	Yes
LV434639	Breaker NSX400 3P 70k Micrologic 7.3 400	C40H37E400	NSX400H 70kAAC 3P3D 400A 7.3E	Yes	Yes
LV434640	Breaker NSX630 4P 70k Micrologic 7.3 570	C63H47E570	NSX630H 70kAAC 4P4D 570A 7.3E	Yes	Yes
LV434641	Breaker NSX400 4P 70k Micrologic 7.3 400	C40H47E400	NSX400H 70kAAC 4P4D 400A 7.3E	Yes	Yes
LV438265	COMPACT NSX250F TM DC 3P CIRCUIT BREAKER	C40F3TM250D	NSX400F 36kA DC 3P 250A TMD	Yes	Yes
LV438266	COMPACT NSX320F TM DC 3P CIRCUIT BREAKER	C40F3TM320D	NSX400F 36kA DC 3P 320A TMD	Yes	Yes
LV438267	COMPACT NSX400F TM DC 3P CIRCUIT BREAKER	C40F3TM400D	NSX400F 36kA DC 3P 400A TMD	Yes	Yes
LV438268	COMPACT NSX500F TM DC 3P CIRCUIT BREAKER	C63F3TM500D	NSX630F 36kA DC 3P 500A TMD	Yes	Yes
LV438269	COMPACT NSX600F TM DC 3P CIRCUIT BREAKER	C63F3TM600D	NSX630F 36kA DC 3P 600A TMD	Yes	Yes
LV438275	COMPACT NSX250S TM DC 3P CIRCUIT BREAKER	C40S3TM250D	NSX400S 100kA DC 3P 250A TMD	Yes	Yes
LV438276	COMPACT NSX320S TM DC 3P CIRCUIT BREAKER	C40S3TM320D	NSX400S 100kA DC 3P 320A TMD	Yes	Yes
LV438277	COMPACT NSX400S TM DC 3P CIRCUIT BREAKER	C40S3TM400D	NSX400S 100kA DC 3P 400A TMD	Yes	Yes
LV438278	COMPACT NSX500S TM DC 3P CIRCUIT BREAKER	C63S3TM500D	NSX630S 100kA DC 3P 500A TMD	Yes	Yes
LV438279	COMPACT NSX600S TM DC 3P CIRCUIT BREAKER	C63S3TM600D	NSX630S 100kA DC 3P 600A TMD	Yes	Yes
LV438260	COMPACT NSX250F TM DC 4P CIRCUIT BREAKER	C40F4TM250D	NSX400F 36kA DC 4P 250A TMD	Yes	Yes
LV438261	COMPACT NSX320F TM DC 4P CIRCUIT BREAKER	C40F4TM320D	NSX400F 36kA DC 4P 320A TMD	Yes	Yes
LV438262	COMPACT NSX400F TM DC 4P CIRCUIT BREAKER	C40F4TM400D	NSX400F 36kA DC 4P 400A TMD	Yes	Yes
LV438263	COMPACT NSX500F TM DC 4P CIRCUIT BREAKER	C63F4TM500D	NSX630F 36kA DC 4P 500A TMD	Yes	Yes
LV438264	COMPACT NSX600F TM DC 4P CIRCUIT BREAKER	C63F4TM600D	NSX630F 36kA DC 4P 600A TMD	Yes	Yes
LV438270	COMPACT NSX250S TM DC 4P CIRCUIT BREAKER	C40S4TM250D	NSX400S 100kA DC 4P 250A TMD	Yes	Yes
LV438271	COMPACT NSX320S TM DC 4P CIRCUIT BREAKER	C40S4TM320D	NSX400S 100kA DC 4P 320A TMD	Yes	Yes
LV438272	COMPACT NSX400S TM DC 4P CIRCUIT BREAKER	C40S4TM400D	NSX400S 100kA DC 4P 400A TMD	Yes	Yes
LV438273	COMPACT NSX500S TM DC 4P CIRCUIT BREAKER	C63S4TM500D	NSX630S 100kA DC 4P 500A TMD	Yes	Yes
LV438274	COMPACT NSX600S TM DC 4P CIRCUIT BREAKER	C63S4TM600D	NSX630S 100kA DC 4P 600A TMD	Yes	Yes
LV438545	NSX630 TM DC 2P wo bare cable connector	C1BN2TM630D	NSX1200N 50kA DC 2P 630A TMD	Yes	Yes
LV438546	NSX800 TM DC 2P wo bare cable connector	C1BN2TM800D	NSX1200N 50kA DC 2P 800A TMD	Yes	Yes
LV438547	NSX1000 TM DC 2P wo bare cable connector	C1BN2TM10HD	NSX1200N 50kA DC 2P 1000A TMD	Yes	Yes
LV438548	NSX1200 TM DC 2P wo bare cable connector	C1BN2TM12HD	NSX1200N 50kA DC 2P 1200A TMD	Yes	Yes
LV438153	COMPACT NSX400 NA DC 3P	C403400DS	SWITCH NSX400NA DC 3P 400A	Yes	Yes
LV438154	COMPACT NSX630 NA DC 3P	C633630DS	SWITCH NSX630NA DC 3P 630A	Yes	Yes
LV438151	COMPACT NSX400 NA DC 4P	C404400DS	SWITCH NSX400NA DC 4P 400A	Yes	Yes
LV438152	COMPACT NSX630 NA DC 4P	C634630DS	SWITCH NSX630NA DC 4P 630A	Yes	Yes
LV438451	COMPACT NSX250 TMDC PV 4P CIRCUIT BREAKER	C40F4TM250D1	NSX400F 36kA DCPV 4P 250A TMD	Yes	Yes
LV438452	COMPACT NSX320 TMDC PV 4P CIRCUIT BREAKER	C40F4TM320D1	NSX400F 36kA DCPV 4P 320A TMD	Yes	Yes
LV438453	COMPACT NSX400 TMDC PV 4P CIRCUIT BREAKER	C40F4TM400D1	NSX400F 36kA DCPV 4P 400A TMD	Yes	Yes
LV438454	COMPACT NSX500 TMDC PV 4P CIRCUIT BREAKER	C63F4TM500D1	NSX630F 36kA DCPV 4P 500A TMD	Yes	Yes
LV438300	SWITCH COMPACT NSX400 NA DC PV 4P	C404400D1S	SWITCH NSX400NA DCPV 4P 400A	Yes	Yes
LV438500	SWITCH COMPACT NSX500 NA DC PV 4P	C634500D1S	SWITCH NSX630NA DCPV 4P 500A	Yes	Yes
LV438451	COMPACT NSX250 TMDC PV 4P CIRCUIT BREAKER	C40F4TM250D1	NSX400F 36kA DCPV 4P 250A TMD	Yes	Yes
LV438452	COMPACT NSX320 TMDC PV 4P CIRCUIT BREAKER	C40F4TM320D1	NSX400F 36kA DCPV 4P 320A TMD	Yes	Yes
LV438453	COMPACT NSX400 TMDC PV 4P CIRCUIT BREAKER	C40F4TM400D1	NSX400F 36kA DCPV 4P 400A TMD	Yes	Yes
LV438454	COMPACT NSX500 TMDC PV 4P CIRCUIT BREAKER	C63F4TM500D1	NSX630F 36kA DCPV 4P 500A TMD	Yes	Yes
LV438300	SWITCH COMPACT NSX400 NA DC PV 4P	C404400D1S	SWITCH NSX400NA DCPV 4P 400A	Yes	Yes
LV438500	SWITCH COMPACT NSX500 NA DC PV 4P	C634500D1S	SWITCH NSX630NA DCPV 4P 500A	Yes	Yes

Energy Management Business Power Product Line of Business

Conformity Declaration **Déclaration de conformité**

Product : **New ComPacT NSX & NSXm ranges**

We, Schneider-Electric, declare that the New ComPacT NSX & NSXm ranges have identical platform as current ComPacT NSX & NSXm ranges.

The new ComPacT NSX & NSXm ranges are built based on the same technical and dimensional architecture. The electrical and mechanical performances remain identical.



Bruno Colin
Schneider Electric Industries
Energy Management Business
Power Product Customer Satisfaction & Quality Director

Schneider Electric Industries SAS

Postal address / Adresse postale :

38EQI

31 Rue Pierre Mendès France 38320 EYBENS

Erreur ! Nom de propriété de document inconnu.

Erreur ! Nom de propriété de document inconnu.

<http://www.schneider-electric.com>

Legal information / Mentions légales

Société par actions simplifiée au capital de 370 000 000 euros

421 106 709 RCS Nanterre – code APE : 2712Z

Siret : 421 106 709 00668

n° ident. TVA : FR 93 421 106 709

siège social : 35 rue Joseph Monier

F – 92500 Rueil-Malmaison

Life Is On



Schneider Electric Industries SAS

35, rue Joseph Monier
CS 30323
92506 Rueil Malmaison Cedex
France

RCS Nanterre 954 503 439
Capital social 928 298 512 €
www.se.com

04-2021

© 2021 - Schneider Electric. All Rights Reserved.
All trademarks are owned by Schneider Electric Industries SAS or its affiliated companies.
Document reference: LVPED221003EN