



Low voltage AC drives

# ABB industrial drives ACS880, single drives 0.55 to 2800 kW Catalog

# What does all-compatible mean for you?

Being all-compatible means that drive choice should add value to your business. Drives should meet the unique demands of your processes, help you save energy and reduce operating costs. Also, all-compatible means that our drives are easy to select, use and maintain. These are the cornerstones making our industrial drive series the all-compatible choice.

## Contents

3	The all-compatible ACS880 series drives
4	Simplifying your world without limiting your possibilities
5	Single drives, ACS880
6	Human all-compatible
7	Process all-compatible
8	Environment all-compatible
9	Business all-compatible
10	How to select a drive
10	Technical data
11	Wall-mounted single drives, ACS880-01
12-13	Ratings, types and voltages, ACS880-01
14	Cabinet-built single drives, ACS880-07
15-16	Ratings, types and voltages, ACS880-07
17	Standard interface and extensions for comprehensive connectivity
18	Standard software for scalable control and functionality
19	Ready made programs for application control
20	Intuitive human-machine interface
21	PC tool for easy startup and maintenance
22	Integrated safety simplifies configuration
23	Drive application programming with CODESYS
24	Flexible connectivity to automation networks
25	Input/output extension modules for increased connectivity
25	Speed feedback interfaces for precise process control
25	I/O option extension adapter
25	DDCS communication option modules
25	Remote monitoring access worldwide
26	EMC – electromagnetic compatibility
26	Brake options
27-28	Brake options, ACS880-01
28	Brake options, ACS880-07
29-30	du/dt filters
31	Dimensioning tool for selecting the optimal drive
32	Expertise at every stage of the value chain
33	Secure uptime throughout the drive life cycle

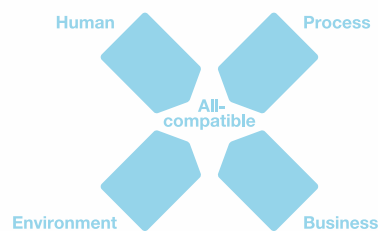

## The all-compatible ACS880 series drives

The ACS880 series drives are part of ABB's all-compatible drives portfolio. Compatible with virtually all types of processes, automation systems, users and business requirements they are designed to tackle any motor-driven application, in any industry, whatever the power range. The innovation behind all-compatibility is our new drives architecture that simplifies operation, optimizes energy efficiency and helps maximize process output. The ACS880 series consists of single drives, multidrives and drive modules.

# Simplifying your world without limiting your possibilities

## Wide range of safety features

Safe torque off is built-in as standard. An optional safety functions module provides extended safety functions, simplifying the configuration and reducing installation space.



## Drive application programming

Customizable to meet the precise application needs using CODESYS programming. The drive is also easy to integrate with other ABB components such as PLC and HMI.



## Direct torque control (DTC)

ABB's signature motor control technology provides precise speed and torque control for all applications and virtually any type of AC motor.



## Application control programs

A range of ready-made programs to optimize application productivity and usability.

## Removable memory unit

Stores all the software and parameter configurations in an easily replaceable and simple-to-install module.



## Energy efficiency

The drive provides features such as an energy optimizer and energy efficiency information that help you monitor and save energy used in the processes.



## Remote monitoring

With a built-in web server, NETA-21 enables worldwide access to drives.

## Drive-to-drive link

Allows fast communication between drives including master-follower configurations without any additional hardware.



## Single drives, ACS880

The all-compatible drives are designed to provide customers across industries and applications with unprecedented levels of compatibility and flexibility.

Our ACS880 single drives are stand alone drives. They are customized to meet the precise needs of industries such as oil and gas, mining, metals, chemicals, cement, power plants, material handling, pulp and paper, sawmills and marine. They control a wide range of applications such as cranes, extruders, winches, winders, conveyors, mixers, compressors, pumps and fans.



### Intuitive human-machine interface

Intuitive, high-contrast and high-resolution display enabling easy navigation in multiple languages.



### Startup and maintenance tool

PC tool for drive startup, configuration and daily use and process tuning. PC tool is connected to the drive via Ethernet or USB interface.



### Communication with all major automation networks

Fieldbus adapters enable connectivity with all major automation networks.



### Extended connectivity

In addition to the standard interfaces, the drive has three built-in slots for additional input/output extension modules and speed feedback interfaces.

### Flexible product configurations

Drives are built to order with a wide range of options such as EMC filters, braking options and different enclosure variants.



## Human all-compatible

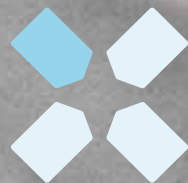

The new drives share easy-to-use interfaces saving you time during drive commissioning and maintenance. When you have learned it once, you can use it with all the drives in our all-compatible drives portfolio.

The new control panel supports over 20 languages. The new PC tool provides extensive drive monitoring capabilities and quick access to the drive settings. Integrated and certified safety features provide safety for machine operators.





## Process all-compatible

The drives are compatible with all kinds of processes. They control virtually any type of AC motor, provide extensive input/output connectivity and support all major fieldbus protocols. The drives cover a wide voltage and power range. Control performance is scalable from basic to demanding applications delivered by direct torque control (DTC). The flexibility and scalability of the drives enable one drive platform to control virtually any application or process, making your drive selection easy.



## Environment all-compatible

There is an increased demand for reducing industries' impact on the environment. Our drives can help you reduce energy consumption in a wide range of applications. The new drives have an energy optimizer feature that ensures maximum torque per ampere, reducing energy drawn from the supply. The built-in energy efficiency calculators help you to analyze and optimize processes. We can help you to investigate the energy saving potential of selected applications with our six-step energy appraisal. Our services expand through the life cycle of the drive and help you maintain energy efficiency from installation and commissioning to drive replacement.

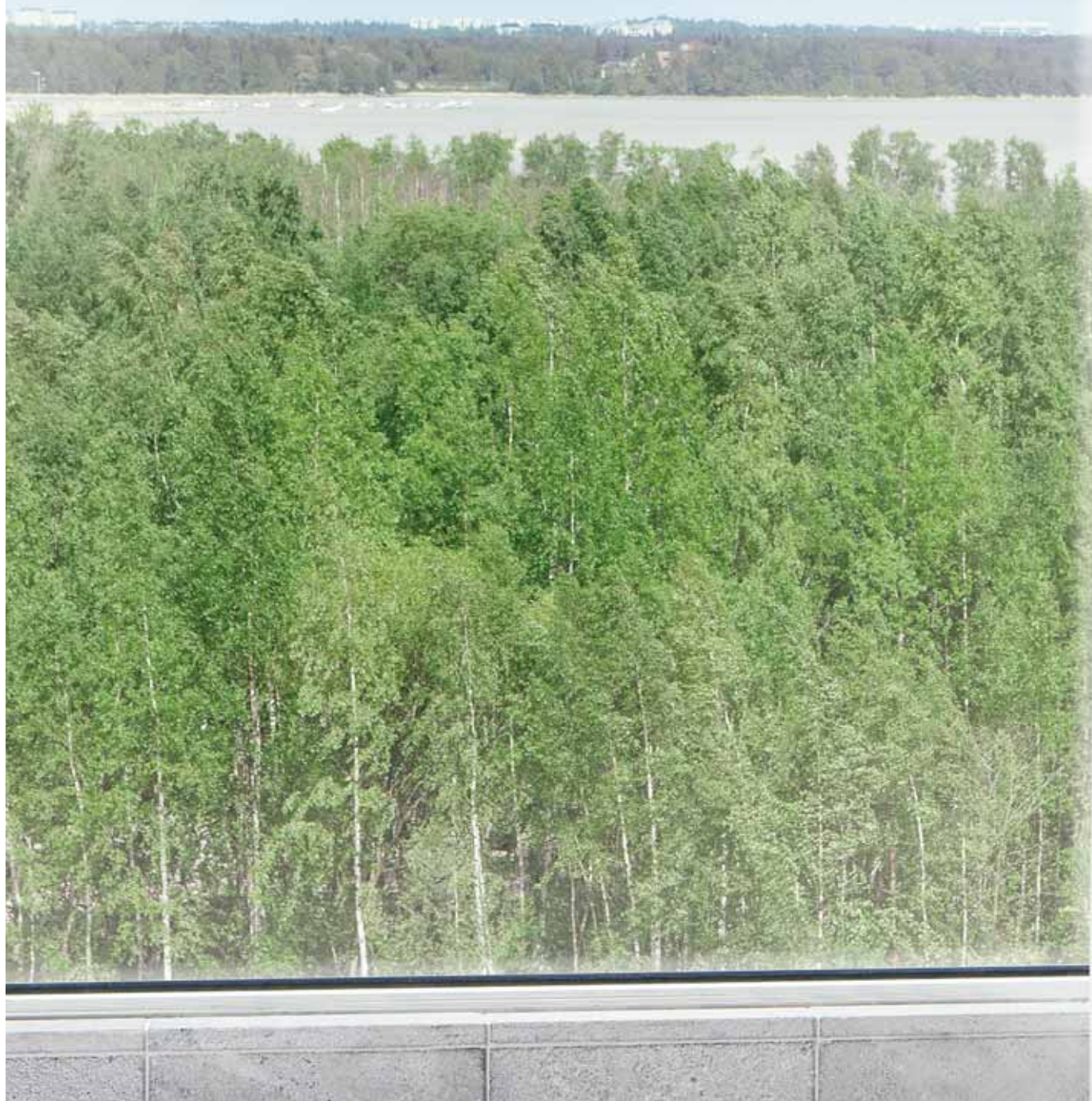





## Business all-compatible

The new all-compatible drives are not just equipment but part of your business strategy. Providing better control over your processes, the new drives equal lower energy consumption, improved productivity, flexibility and ease of use. In addition to drives we offer a wide range of products and services to support your business. With offices in over 90 countries and a global technical partner network, we are in a good position to offer technical advice and local support, worldwide.

# How to select a drive

Many of the features for the ACS880 single drives are built-in as standard, making selection easy. A wide range of options are available to optimize the drive for different requirements. To choose the right drive for your application, please refer to the rating tables on page 12, 13 and 15 or use ABB's DriveSize dimensioning tool (page 19). The selected drive

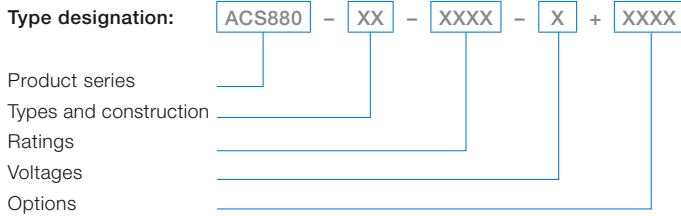

## Technical data

Mains connection	
<b>Voltage and power range</b>	3-phase, $U_{N2}$ = 208 to 240 V, +10%/-15% (-01) 3-phase, $U_{N3}$ = 380 to 415 V, +10%/-15% (-01), ±10 % (-07) 3-phase, $U_{N5}$ = 380 to 500 V, +10%/-15% (-01), ±10 % (-07) 3-phase, $U_{N7}$ = 525 to 690 V, +10%/-15% (-01), ±10 % (-07) 0.55 to 250 kW (-01) 45 to 2800 kW (-07)
<b>Frequency</b>	50/60 Hz ±5%
<b>Power factor</b>	$\cos\phi_1$ = 0.98 (fundamental) $\cos\phi$ = 0.93 to 0.95 (total)
<b>Efficiency (at nominal power)</b>	98%
Motor connection	
<b>Voltage</b>	3-phase output voltage 0 to $U_{N2}/U_{N3}/U_{N5}/U_{N7}$
<b>Frequency</b>	0 to ±500 Hz* **
<b>Motor control</b>	Direct torque control (DTC)
<b>Torque control:</b>	Torque step rise time:
Open loop	<5 ms with nominal torque
Closed loop	<5 ms with nominal torque
	Non-linearity:
Open loop	± 4% with nominal torque
Closed loop	± 3% with nominal torque
<b>Speed control:</b>	Static accuracy:
Open loop	10% of motor slip
Closed loop	0.01% of nominal speed
	Dynamic accuracy:
Open loop	0.3 to 0.4% seconds with 100% torque step
Closed loop	0.1 to 0.2% seconds with 100% torque step
Product compliance	
<ul style="list-style-type: none"> <li>- CE</li> <li>- Low Voltage Directive 2006/95/EC</li> <li>- Machinery Directive 2006/42/EC</li> <li>- EMC Directive 2004/108/EC</li> <li>- Quality assurance system ISO 9001 and Environmental system ISO 14001</li> <li>- RoHS</li> <li>- UL***, GOST R, cUL 508A or cUL 508C *** and CSA C22.2 NO.14-10 ***, C-Tick</li> <li>- Functional safety: STO TÜV Nord certificate</li> <li>- ATEX-certified Safe Disconnection Function, Ex II (2) GD (-01)</li> </ul>	
EMC according to EN 61800-3 (2004)	
Categories C3 and C2 with internal option	

has a unique type designation, which identifies the drive by construction, power and voltage range. The options are added to the type designation with a "plus" code. Build up your own ordering code using the type designation key or contact your local ABB drives sales office and let them know your needs/requirements.



Environmental limits	
<b>Ambient temperature</b>	
Transport	-40 to +70 °C
Storage	-40 to +70 °C
Operation (air-cooled)	-15 to +55 °C, no frost allowed (-01) 0 to +50 °C, no frost allowed (-07) +40 to 55 °C with derating (-01) ***** +40 to 50 °C with derating of 1%/1 °C (-07)
<b>Cooling method</b>	
Air-cooled	Dry clean air
<b>Altitude</b>	
0 to 1,000 m	Without derating
1,000 to 4,000 m	With derating of 1%/100 m
<b>Relative humidity</b>	5 to 95%, no condensation allowed
<b>Degree of protection</b>	
IP21	Standard (-01)
IP22	Standard (-07)
IP42, IP54	Option (-07)
IP55	Option (-01)
<b>Paint color</b>	RAL 9017 (-01, -07), RAL 9002 (-01), RAL 7035 (-07)
<b>Contamination levels</b>	No conductive dust allowed
<b>Storage</b>	IEC 60721-3-1, Class 1C2 (chemical gases), Class 1S2 (solid particles)
<b>Transportation</b>	IEC 60721-3-2, Class 2C2 (chemical gases), Class 2S2 (solid particles)
<b>Operation</b>	IEC 60721-3-3, Class 3C2 (chemical gases), Class 3S2 (solid particles)
<b>Functional safety</b>	
Standard	Safe torque off (STO according EN 61800-5-2) IEC 61508 ed2: SIL 3, IEC 61511: SIL 3, IEC 62061: SIL CL 3, EN ISO 13849-1: PL e
With internal safety option (FSO-11)	Safe stop 1 (SS1), safely-limited speed (SLS), safe stop emergency (SSE), safe brake control, (SBC) and safe maximum speed (SMS) IEC 61508 ed2: SIL 3, IEC 61511: SIL 3, IEC 62061: SIL CL 3, EN ISO 13849-1: PL e TÜV Nord certified *****

C = chemically active substances

S = mechanically active substances

\* For higher output frequencies please contact your local ABB office

\*\* The operational frequency of the FSO-11 is up to 200 Hz of the drives output

\*\*\* 380 to 500 V AC available (for -01 as IP21, -07)

\*\*\*\* Please check availability for -07

\*\*\*\*\* Please see pages 12 to 13 for further details

# Wall-mounted single drives, ACS880-01

Our wall-mounted drives are designed on ABB's common drives architecture. They are customized to the precise needs of industries such as oil and gas, mining, metals, chemicals, cement, power plants, material handling, pulp and paper, sawmills and marine. They are designed to control a wide range of applications including cranes, extruders, winches, winders, conveyors, mixers, compressors, pumps and fans. The drive comes in nine different frame sizes (R1 to R9) for easy installment and commissioning.

At the heart of the drive is direct torque control (DTC), ABB's premier motor control technology. The extensive range of options include EMC filters, encoders, resolvers, du/dt filters, sine filters, chokes and brake resistors, as well as application specific software. Built-in safety features reduce the need for external safety components.

Multiple drives can be daisy-chained for synchronized drive-to-drive communication. The drives offering includes enclosure classes IP21 and IP55 for dusty and wet environments.

ABB provides an extensive selection of support documentation for planning including dimension drawings in different formats, EPLAN P8 macros and helping in line apparatus selection tool.

## Main features include

- Enclosure classes IP21 and IP55 for different environments
- Compact design for easy installation, commissioning and maintenance
- Incoming air temperature measurement for protecting the drive from different temperature related failure mechanisms
- Integrated safety including safe torque off (STO) as standard (TÜV Nord certificate) with the optional safety functions module (FSO-11)
- Supports various motor types including synchronous reluctance motors
- Intuitive control panel with USB connection
- Removable memory unit for easy maintenance
- Drive composer PC tool for commissioning and configuration
- Primary control program - common software used throughout the ACS880 drive series
- Control unit supporting a wide range of fieldbuses, feedback devices and input/output options
- Coated boards as standard
- Controllable cooling fan
- Built-in braking chopper option for frame sizes R5 to R9
- EMC filter option
- du/dt filter option for motor protection
- Built-in choke



ACS880-01, frame sizes R1 to R9, IP21

ACS880-01, frame size R3, IP55

# Ratings, types and voltages

## Wall-mounted drives, ACS880-01

$U_N = 230\text{ V}$  (range 208 to 240 V). The power ratings are valid at nominal voltage 230 V (0.55 to 7.5 kW).

Nominal ratings			Light-overload use		Heavy-duty use		Noise level	Heat dissipation	Air flow	Type designation	Frame size
$I_N$ A	$I_{max}$ A	$P_N$ kW	$I_{Ld}$ A	$P_{Ld}$ kW	$I_{Hd}$ A	$P_{Hd}$ kW	dBA	W	m <sup>3</sup> /h		
4.6	6.3	0.75	4.4	0.75	3.7	0.55	46	73	44	ACS880-01-04A6-2	R1
6.6	7.8	1.1	6.3	1.1	4.6	0.75	46	94	44	ACS880-01-06A6-2	R1
7.5	11.2	1.5	7.1	1.5	6.6	1.1	46	122	44	ACS880-01-07A5-2	R1
10.6	12.8	2.2	10.1	2.2	7.5	1.5	46	172	44	ACS880-01-10A6-2	R1
16.8	18.0	4.0	16.0	4.0	10.6	2.2	51	232	88	ACS880-01-16A8-2	R2
24.3	28.6	5.5	23.1	5.5	16.8	4.0	51	337	88	ACS880-01-24A3-2	R2
31.0	41	7.5	29.3	7.5	24.3	5.5	57	457	134	ACS880-01-031A-2	R3
46	64	11	44	11	38	7.5	62	500	200	ACS880-01-046A-2	R4
61	76	15	58	15	45	11.0	62	630	200	ACS880-01-061A-2	R4
75	104	18.5	71	18.5	61	15	62	680	280	ACS880-01-075A-2	R5
87	122	22	83	22	72	18.5	62	730	280	ACS880-01-087A-2	R5
115	148	30	109	30	87	22.0	67	840	435	ACS880-01-115A-2	R6
145	178	37	138	37	105	30.0	67	940	435	ACS880-01-145A-2	R6
170	247	45	162	45	145	37	67	1260	450	ACS880-01-170A-2	R7
206	287	55	196	55	169	45	67	1500	450	ACS880-01-206A-2	R7
274	362	75	260	75	213	55	65	2100	550	ACS880-01-274A-2	R8***

$U_N = 400\text{ V}$  (range 380 to 415 V). The power ratings are valid at nominal voltage 400 V (0.55 to 250 kW).

Nominal ratings			Light-overload use		Heavy-duty use		Noise level	Heat dissipation	Air flow	Type designation	Frame size
$I_N$ A	$I_{max}$ A	$P_N$ kW	$I_{Ld}$ A	$P_{Ld}$ kW	$I_{Hd}$ A	$P_{Hd}$ kW	dBA	W	m <sup>3</sup> /h		
2.4	3.1	0.75	2.3	0.75	1.8	0.55	46	30	44	ACS880-01-02A4-3	R1
3.3	4.1	1.1	3.1	1.1	2.4	0.75	46	40	44	ACS880-01-03A3-3	R1
4.0	5.6	1.5	3.8	1.5	3.3	1.1	46	52	44	ACS880-01-04A0-3	R1
5.6	6.8	2.2	5.3	2.2	4.0	1.5	46	73	44	ACS880-01-05A6-3	R1
7.2	9.5	3.0	6.8	3.0	5.6	2.2	46	94	44	ACS880-01-07A2-3	R1
9.4	12.2	4.0	8.9	4.0	7.2	3.0	46	122	44	ACS880-01-09A4-3	R1
12.6	16.0	5.5	12.0	5.5	9.4	4.0	46	172	44	ACS880-01-12A6-3	R1
17	21	7.5	16	7.5	12.6	5.5	51	232	88	ACS880-01-017A-3	R2
25	29	11	24	11	17	7.5	51	337	88	ACS880-01-025A-3	R2
32	42	15	30	15	25	11	57	457	134	ACS880-01-032A-3	R3
38	54	18.5	36	18.5	32	15	57	562	134	ACS880-01-038A-3	R3
45	64	22	43	22	38	19	62	667	200	ACS880-01-045A-3	R4
61	76	30	58	30	45	22	62	907	200	ACS880-01-061A-3	R4
72	104	37	68	37	61	30	62	1117	280	ACS880-01-072A-3	R5
87	122	45	83	45	72	37	62	1120	280	ACS880-01-087A-3	R5
105	148	55	100	55	87	45	67	1295	435	ACS880-01-105A-3	R6
145	178	75	138	75	105	55	67	1440	435	ACS880-01-145A-3	R6
169	247	90	161	90	145	75	67	1940	450	ACS880-01-169A-3	R7
206	287	110	196	110	169	90	67	2310	450	ACS880-01-206A-3	R7
246	350	132	234	132	206	110	65	3300	550	ACS880-01-246A-3	R8
293	418	160	278	160	246*	132	65	3900	550	ACS880-01-293A-3	R8***
363	498	200	345	200	293	160	68	4800	1150	ACS880-01-363A-3	R9
430	545	250	400	200	363**	200	68	6000	1150	ACS880-01-430A-3	R9



# Ratings, types and voltages

## Wall-mounted drives, ACS880-01

$U_N = 500\text{ V}$  (range 380 to 500 V). The power ratings are valid at nominal voltage 500 V (0.55 to 250 kW).

Nominal ratings			Light-overload use		Heavy-duty use		Noise level	Heat dissipation	Air flow	Type designation	Frame size
$I_N$ A	$I_{max}$ A	$P_N$ kW	$I_{Ld}$ A	$P_{Ld}$ kW	$I_{Hd}$ A	$P_{Hd}$ kW	dBA	W	m <sup>3</sup> /h		
2.1	3.1	0.75	2.0	0.75	1.7	0.55	46	30	44	ACS880-01-02A1-5	R1
3.0	4.1	1.1	2.8	1.1	2.1	0.75	46	40	44	ACS880-01-03A0-5	R1
3.4	5.6	1.5	3.2	1.5	3.0	1.1	46	52	44	ACS880-01-03A4-5	R1
4.8	6.8	2.2	4.6	2.2	3.4	1.5	46	73	44	ACS880-01-04A8-5	R1
5.2	9.5	3.0	4.9	3.0	4.8	2.2	46	94	44	ACS880-01-05A2-5	R1
7.6	12.2	4.0	7.2	4.0	5.2	3.0	46	122	44	ACS880-01-07A6-5	R1
11.0	16.0	5.5	10.4	5.5	7.6	4.0	46	172	44	ACS880-01-11A0-5	R1
14	21	7.5	13	7.5	11	5.5	51	232	88	ACS880-01-014A-5	R2
21	29	11	19	11	14	7.5	51	337	88	ACS880-01-021A-5	R2
27	42	15	26	15	21	11	57	457	134	ACS880-01-027A-5	R3
34	54	18.5	32	18.5	27	15	57	562	134	ACS880-01-034A-5	R3
40	64	22	38	22	34	19	62	667	200	ACS880-01-040A-5	R4
52	76	30	49	30	40	22	62	907	200	ACS880-01-052A-5	R4
65	104	37	62	37	52	30	62	1117	280	ACS880-01-065A-5	R5
77	122	45	73	45	65	37	62	1120	280	ACS880-01-077A-5	R5
96	148	55	91	55	77	45	67	1295	435	ACS880-01-096A-5	R6
124	178	75	118	75	96	55	67	1440	435	ACS880-01-124A-5	R6
156	247	90	148	90	124	75	67	1940	450	ACS880-01-156A-5	R7
180	287	110	171	110	156	90	67	2310	450	ACS880-01-180A-5	R7
240	350	132	228	132	180	110	65	3300	550	ACS880-01-240A-5	R8****
260	418	160	247	160	240*	132	65	3900	550	ACS880-01-260A-5	R8***
361	542	200	343	200	302	200	68	4800	1150	ACS880-01-361A-5	R9
414	542	250	393	250	361**	200	68	6000	1150	ACS880-01-414A-5	R9

$U_N = 690\text{ V}$  (range 525 to 690 V). The power ratings are valid at nominal voltage 690 V (4 to 250 kW).

Nominal ratings			Light-overload use		Heavy-duty use		Noise level	Heat dissipation	Air flow	Type designation	Frame size
$I_N$ A	$I_{max}$ A	$P_N$ kW	$I_{Ld}$ A	$P_{Ld}$ kW	$I_{Hd}$ A	$P_{Hd}$ kW	dBA	W	m <sup>3</sup> /h		
7.3	12.2	5.5	6.9	5.5	5.6	4	62	217	280	ACS880-01-07A3-7	R5
9.8	18	7.5	9.3	7.5	7.3	5.5	62	284	280	ACS880-01-09A8-7	R5
14.2	22	11	13.5	11	9.8	7.5	62	399	280	ACS880-01-14A2-7	R5
18	29	15	17	15	14.2	11	62	490	280	ACS880-01-018A-7	R5
22	44	18.5	21	18.5	18	15	62	578	280	ACS880-01-022A-7	R5
26	54	22	25	22	22	18.5	62	660	280	ACS880-01-026A-7	R5
35	64	30	33	30	26	22	62	864	280	ACS880-01-035A-7	R5
42	70	37	40	37	35	30	62	998	280	ACS880-01-042A-7	R5
49	71	45	47	45	42	37	62	1120	280	ACS880-01-049A-7	R5
61	104	55	58	55	49	45	67	1295	435	ACS880-01-061A-7	R6
84	124	75	80	75	61	55	67	1440	435	ACS880-01-084A-7	R6
98	168	90	93	90	84	75	67	1940	450	ACS880-01-098A-7	R7
119	198	110	113	110	98	90	67	2310	450	ACS880-01-119A-7	R7
142	250	132	135	132	119	110	65	3300	550	ACS880-01-142A-7	R8
174	274	160	165	160	142	132	65	3900	550	ACS880-01-174A-7	R8
210	384	200	200	200	174	160	68	4800	1150	ACS880-01-210A-7	R9
271	411	250	257	250	210	200	68	6000	1150	ACS880-01-271A-7	R9

### Nominal ratings

$I_N$	Rated current available continuously without overloadability at 40 °C.
$P_N$	Typical motor power in no-overload use.
$I_{max}$	Maximum output current. Available for 10 seconds at start, then as long as allowed by drive temperature.

### Light-overload use

$I_{Ld}$	Continuous current allowing 110% $I_{Ld}$ for 1 min/5 min at 40 °C.
$P_{Ld}$	Typical motor power in light-overload use.

### Heavy-duty use

$I_{Hd}$	Continuous current allowing 150% $I_{Hd}$ for 1 min/5 min at 40 °C.
$P_{Hd}$	Typical motor power in heavy-duty use.

The ratings apply at 40 °C ambient temperature. At higher temperatures (up to 55 °C) the derating is 1%/1 °C.

\* 130% overload

\*\* 125% overload

\*\*\* The ratings apply at 40 °C ambient temperature. At higher temperature the derating is from 40 to 45 °C 1%/1 °C and 45 to 55 °C 2.5%/1 °C.

\*\*\*\* The ratings apply at 40 °C ambient temperature. At higher temperature the derating is from 40 to 50 °C 1%/1 °C and 50 to 55 °C 2.5%/1 °C.

Frame size	Height 1 IP21 (mm)	Height 2 IP21 (mm)	Width (mm)	Depth (mm)	Weight (kg)
R1	405	370	155	226	6
R2	405	370	155	249	8
R3	471	420	172	261	10
R4	573	490	203	274	18.5
R5	730	596	203	274	23
R6	726	569	251	357	45
R7	880	600	284	365	55
R8	963	681	300	386	70
R9	955	680	380	413	98

H1 = Height with cable entry box

H2 = Height without cable entry box

Width and depth with cable entry box

Frame size	Height IP55 (mm)	Width IP55 (mm)	Depth IP55 (mm)	Weight IP55 (kg)
R1	450	162	295	6
R2	450	162	318	8
R3	525	180	330	10
R4	576	203	344	15
R5	730	203	344	23
R6	726	251	421	45
R7	880	284	423	55

# Cabinet-built single drives, ACS880-07

Our cabinet-built single drives are built to order, meeting customer needs despite any technical challenges. Designed on ABB's common drives architecture, this compact drive comes in different sizes for easy assembly and commissioning.

These single drives are customized to the precise needs of industries such as oil and gas, mining, metals, chemicals, cement, power plants, material handling, pulp and paper, woodworking and marine. Typical applications include cranes, extruders, winches, conveyors, mixers, compressors, pumps and fans. The drive configuration contains a rectifier, DC link and an inverter, all built into a compact cabinet. The features and options include extended inputs and outputs, fieldbus options, du/dt filtering, EMC filtering, a brake resistor, fuses and a main switch.

Induction motors, synchronous motors and induction servo motors are all supported as standard without the need for additional software. The drive can control the motors in either open loop or closed loop, through its high precision motor control platform, direct torque control (DTC). Built-in safety features reduce the need for external safety components.

## Main features include

- Compact design for easy cabinet assembly and maintenance
- Cabling solutions include bottom and top entry and exit cabling
- Enclosure classes IP22, IP42 and IP54 for different environments

- Integrated safety including safe torque off (STO) as standard with the optional safety functions module (FSO-11)
- Supports various motor types including synchronous reluctance motors
- Drive composer PC tool for commissioning and configuration
- Intuitive and easy to operate control panel with USB connection
- Device panel for optional switches and pilot light
- Primary control program – common software used throughout the ACS880 drive series
- Control unit ZCU with three inputs and outputs and fieldbus extension slots supporting a wide range of fieldbuses (for frame sizes R10 and R11)
- Control unit BCU is used with all parallel connected modules, such as n×R8i and D×T
- Removable memory unit for easy maintenance
- Coated boards as standard
- Extensive, programmable digital and analog inputs and outputs
- Long lifetime capacitors and cooling fan with on-off control
- Braking option inside the module
- EMC filter option
- du/dt and common mode filter options for motor protection
- Cabinet light and heater option



ACS880-07, frame sizes R6 to R8 and R9, IP22



ACS880-07, frame sizes R6 to R8, IP54

# Ratings, types and voltages

## Cabinet-built drives, ACS880-07

$U_N = 400\text{ V}$  (range 380 to 415 V). The power ratings are valid at nominal voltage 400 V (45 to 1400 kW).

Nominal ratings			Light-overload use		Heavy-duty use		Noise level	Heat dissipation	Air flow	Type designation	Frame size
$I_N$ A	$I_{max}$ A	$P_N$ kW	$I_{Ld}$ A	$P_{Ld}$ kW	$I_{Hd}$ A	$P_{Hd}$ kW	dBA	W	m <sup>3</sup> /h		
105	148	55	100	55	87	45	67	1795	435	ACS880-07-0105A-3	R6
145	178	75	138	75	105	55	67	1940	435	ACS880-07-0145A-3	R6
169	247	90	161	90	145	75	67	2440	450	ACS880-07-0169A-3	R7
206	287	110	196	110	169	90	67	2810	450	ACS880-07-0206A-3	R7
246	350	132	234	132	206	110	65	3800	550	ACS880-07-0246A-3	R8
293	418	160	278	160	246*	132	65	4400	550	ACS880-07-0293A-3	R8
363	498	200	345	200	293	160	68	5300	1150	ACS880-07-0363A-3	R9
430	545	250	400	200	363**	200	68	6500	1150	ACS880-07-0430A-3	R9
505	560	250	485	250	361	200	72	6100	1200	ACS880-07-0505A-3	R10
585	680	315	575	315	429	250	72	6900	1200	ACS880-07-0585A-3	R10
650	730	355	634	355	477	250	72	8620	1200	ACS880-07-0650A-3	R10
725	850	400	715	400	566	315	72	9270	1200	ACS880-07-0725A-3	R11
820	1020	450	810	450	625	355	72	10360	1200	ACS880-07-0820A-3	R11
880	1100	500	865	500	725*	400	72	11080	1420	ACS880-07-0880A-3	R11
1140	1482	630	1072	560	787	400	73	18000	4290	ACS880-07-1140A-3	1xD8T+2xR8i
1480	1930	800	1421	800	1107	630	74	25000	5720	ACS880-07-1480A-3	2xD8T+2xR8i
1760	2120	1000	1690	900	1316	710	74	29000	5720	ACS880-07-1760A-3	2xD8T+2xR8i
2610	3140	1400	2506	1400	1952	1000	76	44000	8580	ACS880-07-2610A-3	3xD8T+3xR8i

$U_N = 500\text{ V}$  (range 380 to 500 V). The power ratings are valid at nominal voltage 500 V (45 to 1400 kW).

Nominal ratings			Light-overload use		Heavy-duty use		Noise level	Heat dissipation	Air flow	Type designation	Frame size
$I_N$ A	$I_{max}$ A	$P_N$ kW	$I_{Ld}$ A	$P_{Ld}$ kW	$I_{Hd}$ A	$P_{Hd}$ kW	dBA	W	m <sup>3</sup> /h		
96	148	55	91	55	77	45	67	1795	435	ACS880-07-0096A-5	R6
124	178	75	118	75	96	55	67	1940	435	ACS880-07-0124A-5	R6
156	247	90	148	90	124	75	67	2440	450	ACS880-07-0156A-5	R7
180	287	110	171	110	156	90	67	2810	450	ACS880-07-0180A-5	R7
240	350	132	228	132	180	110	65	3800	550	ACS880-07-0240A-5	R8
260	418	160	247	160	240*	132	65	4400	550	ACS880-07-0260A-5	R8
361	542	200	343	200	302	200	68	5300	1150	ACS880-07-0361A-5	R9
414	542	250	393	250	361**	200	68	6500	1150	ACS880-07-0414A-5	R9
460	533	315	450	315	330	200	72	4900	1200	ACS880-07-0460A-5	R10
503	560	355	483	315	361	250	72	6100	1200	ACS880-07-0503A-5	R10
583	680	400	573	400	414	250	72	6910	1200	ACS880-07-0583A-5	R10
635	730	450	623	450	477	315	72	8620	1200	ACS880-07-0635A-5	R10
715	850	500	705	500	566	400	72	9265	1200	ACS880-07-0715A-5	R11
820	1020	560	807	560	625	450	71	10360	1200	ACS880-07-0820A-5	R11
1070	1391	710	1027	710	800	560	73	18000	4290	ACS880-07-1070A-5	1xD8T+2xR8i
1320	1716	900	1267	900	987	710	74	22000	5720	ACS880-07-1320A-5	2xD8T+2xR8i
1580	2060	1100	1517	1000	1182	800	74	27000	5720	ACS880-07-1580A-5	2xD8T+2xR8i
1980	2574	1400	1901	1300	1481	1000	75	36000	7150	ACS880-07-1980A-5	2xD8T+3xR8i

\* 130% overload, \*\* 125% overload

### Nominal ratings

$I_N$	Rated current available continuously without overloadability at 40 °C.
$P_N$	Typical motor power in no-overload use.
$I_{max}$	Maximum output current. Available for 10 seconds at start, then as long as allowed by drive temperature.

### Light-overload use

$I_{Ld}$	Continuous current allowing 110% $I_{Ld}$ for 1 min/5 min at 40 °C.
$P_{Ld}$	Typical motor power in light-overload use.

### Heavy-duty use

$I_{Hd}$	Continuous current allowing 150% $I_{Hd}$ for 1 min/5 min at 40 °C.
$P_{Hd}$	Typical motor power in heavy-duty use.

The ratings apply at 40 °C ambient temperature. At higher temperatures (up to 50 °C) the derating is 1%/1 °C.

# Ratings, types and voltages

## Cabinet-built drives, ACS880-07

$U_N = 690$  V (range 525 to 690 V). The power ratings are valid at nominal voltage 500 V (45 to 2800 kW).

Nominal ratings			Light-overload use		Heavy-duty use		Noise level	Heat dissipation	Air flow	Type designation	Frame size
$I_N$ A	$I_{max}$ A	$P_N$ kW	$I_{Ld}$ A	$P_{Ld}$ kW	$I_{Hd}$ A	$P_{Hd}$ kW	dBA	W	m <sup>3</sup> /h		
61	104	55	58	55	49	45	67	1795	1750	ACS880-07-0061A-7	R6
84	124	75	80	75	61	55	67	1940	1750	ACS880-07-0084A-7	R6
98	168	90	93	90	84	75	67	2440	1750	ACS880-07-0098A-7	R7
119	198	110	113	110	98	90	67	2819	1750	ACS880-07-0119A-7	R7
142	250	132	135	132	119	110	65	3800	1750	ACS880-07-0142A-7	R8
174	274	160	165	160	142	132	65	4400	1750	ACS880-07-0174A-7	R8
210	384	200	200	200	174	160	68	5300	1150	ACS880-07-0210A-7	R9
271	411	250	257	250	210	200	68	6500	1150	ACS880-07-0271A-7	R9
800	1040	800	768	710	598	560	73	16000	4290	ACS880-07-0800A-7	1xD8T+2xR8i
1160	1508	1100	1114	1100	868	800	74	26000	5720	ACS880-07-1160A-7	2xD8T+2xR8i
1650	2145	1600	1584	1500	1234	1200	75	36500	7150	ACS880-07-1650A-7	2xD8T+3xR8i
2300	2990	2200	2208	2000	1720	1600	76	52000	10010	ACS880-07-2300A-7	3xD8T+4xR8i
2860	3720	2800	2746	2400	2139	2000	78	65000	12870	ACS880-07-2860A-7	4xD8T+5xR8i

\* 130% overload, \*\* 125% overload

Frame size	Height IP22/42 (mm)	Height IP54 (mm)	Width (mm)	Depth (mm)	Weight (kg)
R6	2145	2315	430***	673	240
R7	2145	2315	430***	673	250
R8	2145	2315	430***	673	265
R9	2145	2315	830	698	375
R10	2145	2315	830***	698	530
R11	2145	2315	830***	698	580

\*\*\* 200 mm if equipped with 1<sup>st</sup> environment (C2) filter

Frame size	Height IP22/42 (mm)	Height IP54 (mm)	6-pulse width with switch and fuses (mm)	Depth (mm)	Depth top exit (mm)	Weight (kg)
1xD8T+2xR8i	2145	2315	1830	698	898	890
2xD8T+2xR8i	2145	2315	2230	698	898	1200
2xD8T+3xR8i	2145	2315	2430	698	898	1350
3xD8T+3xR8i	2145	2315	2630	698	898	1540
3xD8T+4xR8i	2145	2315	3030	698	898	1690
4xD8T+5xR8i	2145	2315	3630	698	898	2200

### Nominal ratings

$I_N$	Rated current available continuously without overloadability at 40 °C.
$P_N$	Typical motor power in no-overload use.
$I_{max}$	Maximum output current. Available for 10 seconds at start, then as long as allowed by drive temperature.

### Light-overload use

$I_{Ld}$	Continuous current allowing 110% $I_{Ld}$ for 1 min/5 min at 40 °C.
$P_{Ld}$	Typical motor power in light-overload use.

### Heavy-duty use

$I_{Hd}$	Continuous current allowing 150% $I_{Hd}$ for 1 min/5 min at 40 °C.
$P_{Hd}$	Typical motor power in heavy-duty use.

The ratings apply at 40 °C ambient temperature. At higher temperatures (up to 50 °C) the derating is 1%/1 °C.



# Standard interface and extensions for comprehensive connectivity

The ACS880 single drives offers a wide range of standard interfaces. In addition the drive has three option slots that can be used for extensions including fieldbus adapter modules, input/output extension modules, feedback modules and a safety functions module.

input/output extension modules, feedback modules and a safety functions module.

Control connections	Description
2 analog inputs (XAI)	Current input: -20 to 20 mA, $R_{in}$ : 100 ohm Voltage input: -10 to 10 V, $R_{in}$ : 200 kohm Resolution: 11 bit + sign bit
2 analog outputs (XAO)	0 to 20 mA, $R_{load} < 500$ ohm Frequency range: 0 to 300 Hz Resolution: 11 bit + sign bit
6 digital inputs (XDI)	Input type: NPN/PNP (DI1 to DI5), NPN (DI6) DI6 (XDI:6) can alternatively be used as an input for a PTC thermistor.
Digital input interlock (DIIL)	Input type: NPN/PNP
2 digital inputs/outputs (XDIO)	As input: 24 V logic levels: "0" < 5 V, "1" > 15 V $R_{in}$ : 2.0 kohm Filtering: 0.25 ms As output: Total output current from 24 V DC is limited to 200 mA Can be set as pulse train input and output
3 relay outputs (XRO1, XRO2, XRO3)	250 V AC/30 V DC, 2 A
Safe torque off (XSTO)	For the drive to start, both connections must be closed
Drive-to-drive link (XD2D)	Physical layer: EIA-485
Built-in Modbus	EIA-485
Assistant control panel/ PC tool connection	Connector: RJ-45



Control unit ZCU

Example of a typical single drives input/output connection diagram. Variations maybe possible (please see HW manual for more information).

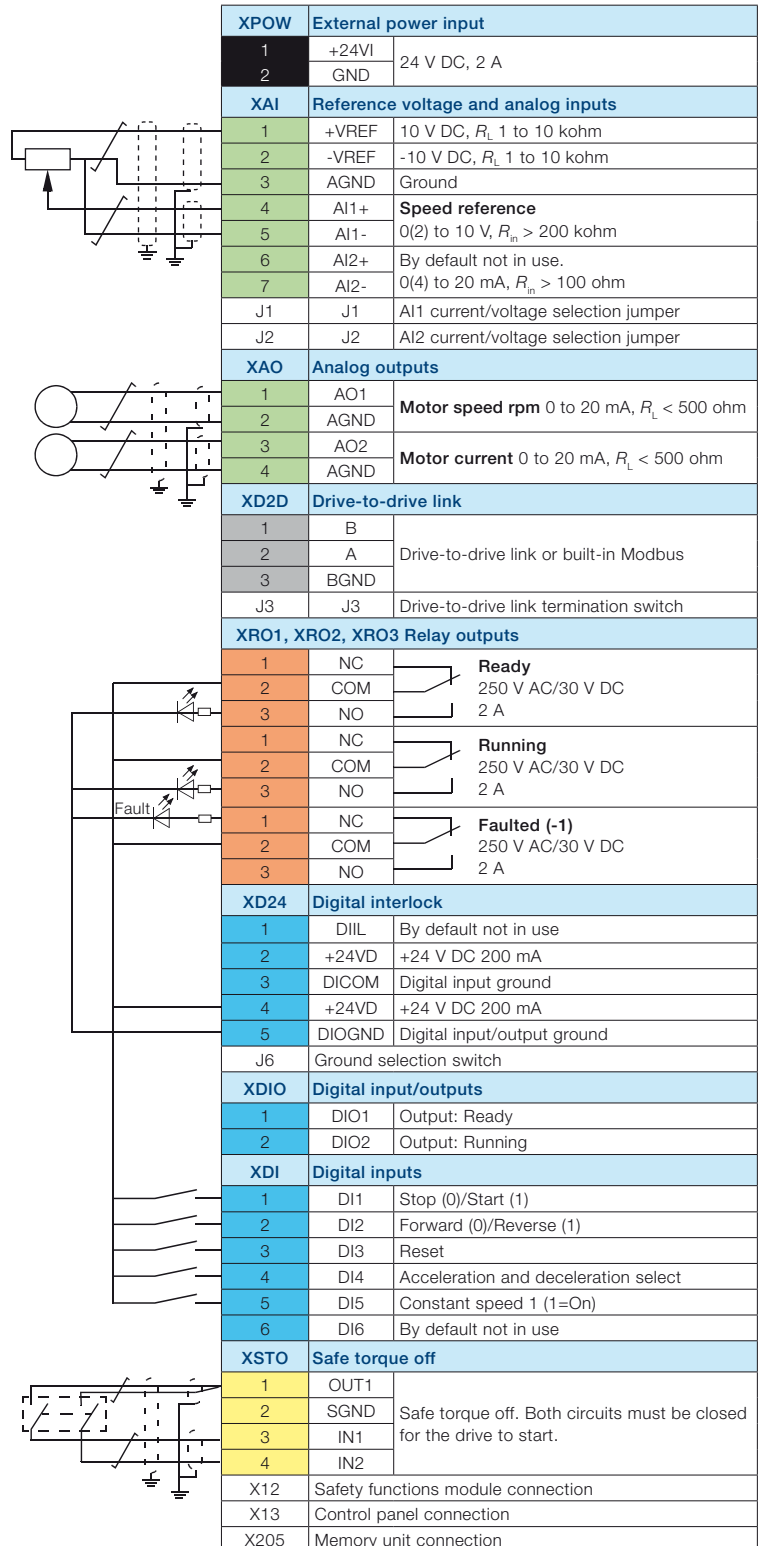

# Standard software for scalable control and functionality

The same software, the primary control program, is used across the whole ACS880 series. Features such as built-in pre-programmed application macros save time during configuration and drive commissioning. The application macros help set parameters for various functions including:

- Basic setup for input/output control and fieldbus adapter control
- Hand/auto control for local and remote operation
- PID control for closed loop processes
- Sequential control for repetitive cycles
- Torque control
- Four user sets, for saving multiple drive configurations

## Direct torque control (DTC)

The drives are equipped with direct torque control (DTC), ABB's signature motor control platform which supports motors such as induction motors, permanent magnet synchronous motors and servo motors and the new synchronous reluctance motor. DTC helps control the motor from standstill to maximum torque and speed without the necessity of encoders or position sensors. DTC allows high overloadability, gives high starting torque and reduces stress on mechanics.

## Energy efficiency information

The drives come with built-in energy efficiency information that helps the user fine-tune processes to ensure optimum energy use. The energy optimizer mode ensures the maximum torque per ampere, reducing energy drawn from the supply. The load profile feature collects drive values with three loggers: two amplitude loggers and one peak value logger. Calculators provide essential energy efficiency information: used and saved electrical energy, CO<sub>2</sub> reduction and money saved.

Additional software features include:

- Access levels
- Adaptive programming
- Automatic reset
- Automatic start
- Constant speeds
- Critical speeds and frequencies
- DC hold
- DC magnetizing
- Diagnostics
- Drive-to-drive link for master-follower control
- Flux braking
- Jogging
- Mechanical brake control
- Output phase order, switches rotation direction of the motor
- Oscillation damping
- Power loss ride-through
- Process PID control with trim function
- Programmable and pre-programmed protection functions
- Programmable inputs and outputs
- Scalar control with IR compensation
- Speed controller with auto tuning
- Startup assistants
- User adjustable load supervision/limitation
- User selectable acceleration and deceleration ramps
- Variable slope

## Removable memory unit

The removable memory unit stores the software that includes user settings, parameter settings and motor data. Situated on the control unit, the memory unit can easily be removed for maintenance, update or replacement purposes. This common type of memory unit is used throughout the ACS880 series.





## Application control programs

Our application control programs are developed by working closely with our customers over many years. This results in application programs that include the lessons learned across many customers, and that are designed to give you the flexibility to adapt the programs to your specific needs. These programs enhance application usability and lower energy consumption. They increase safe operation of the applications and reduce the need for a PLC. Other benefits include protection of machinery and optimization of application productivity. The programs also optimize time usage and lower operational costs.

The ACS880 application control programs come with adaptive programming features. This makes fine tuning of the functionality of the ready-made application control programs easy. Additionally, we understand that you may need to use different configurations in your process. That's why each of our control programs comes with the ability to configure up to four different configurations, or "user sets." The ACS880 drives offer integrated safety with safe torque off (STO) functionality as standard. The optional safety functions module, FSO-11, comes with five safety functions including safe brake control (SBC).

### Control programs for material handling applications

This control program is dedicated for industrial, harbor, tower and marine deck cranes. It is possible to control crane movements in hoist and trolley and travel motions using the same software. The control program comes with integrated mechanical brake control to assure safe opening and closing of the mechanical disc or drum brakes. Standalone and master-follower functionality is supported along with synchro control of multimotors. The synchro control for common operation of the load functionality makes it possible to lift and lower loads, such as containers, in a smooth and balanced way during transportation. The load speed control function maximizes the hoist speed for the given load and ensures that there is sufficient motor torque in the field weakening area. This minimizes operation time and optimizes crane capacity. Fieldbus and conventional I/O control is supported.

### Control program for winder

This control program makes sure that unwinding and winding of a roll of web material, such as textile, plastic and paper is performed optimally. The control program observes the diameter of rolls and tension of the web material and makes sure that the drives controlling different parts of the winder are in sync. Based on the feedback from the dancer or tension measurement of the web, the speed or torque of the drive is adjusted properly. The result is a straightforward, cost-effective solution in web handling. Another feature is the mechanics ID run function that calculates automatically the inertia and friction of the roll. This speeds up the commissioning of the drive.

### Control program for artificial oil lifting

This control program increases oil production for PCP (progressive cavity pumps), ESP (electro submersible pumps) or rod pumps. The program does not require any feedback encoder to work, which saves costs and increases reliability. The software also reduces stress on the complete pump system when optimizing fluid production. Backspin functionality is especially suitable for PCP and ESP pumps, which minimizes failure and makes oil pumping safe. Various startup ramp functions are also available. The sensorless control function (pump off control) helps to optimize oil pumping productivity by keeping the energy usage on a pre-determined level.

### Control program for centrifuge/decanter

This control program is designed to perform practical programmable sequences for conventional centrifuges. The program optimizes the separation of solids from the liquids in centrifuges, separators or decanter centrifuges. The speed difference of the bowl and scrolling in the decanter centrifuge is controlled by the drive-to-drive functionality available in ACS880 drives.

# Intuitive human-machine interface

The assistant control panel features intuitive use and easy navigation. High resolution display enables visual guidance. The panel saves on commissioning and learning time by means of different assistants, making the drive simple to set up and use.

It is possible to organize parameters in different ways and store essential parameters for different configurations for any specialized application needed. The menus and messages can be customized for specific terminology so that each application can be set up and configured to its optimum performance. This makes the drive easier to use with information that is familiar to users. With the panel's text editor, users can also add information, customize text and label the drive. Powerful backup and restore functions

are supported as well as different language versions. The help key provides context sensitive guidance. Faults or warnings can be resolved quickly since the help key provides troubleshooting instructions.

One control panel can be connected to several drives simultaneously using the panel network feature. The user can also select the drive to operate in the panel network. The PC tool can be easily connected to the drive through the USB connector on the control panel. There is also the assistant control panel mounting platform, DPMP-01 IP55 kit available for cabinet door flush mounting.





# PC tool for easy startup and maintenance

The Drive composer PC tool offers fast and harmonized setup, commissioning and monitoring for the whole drives portfolio. The free version of the tool provides startup and maintenance capabilities, while the professional version provides additional features such as custom parameter windows, control diagrams of the drive's configuration and safety settings.

The Drive composer tool is connected to the drive using an Ethernet connection or through the USB connection on the assistant control panel. All drive information such as parameter loggers, faults, backups and event lists are gathered into a support diagnostics file with a single mouse click. This provides faster fault tracking, shortens downtime and minimizes operational and maintenance costs.

## Drive composer pro

Drive composer pro provides basic functionality, including parameter settings, downloading and uploading files and search parameters. Advanced features such as graphical control diagrams and various displays are also available. The control diagrams save users from browsing long lists of parameters and help to set the drive's logic quickly and easily. The tool has fast monitoring capabilities of multiple signals from several drives in a PC tool network. Full backup and restore functions are also included. Safety settings can be configured with Drive composer pro.



# Integrated safety simplifies configuration

Integrated safety reduces the need for external safety components, simplifying configuration and reducing installation space. The safety functionality is a built-in feature of the ACS880, with safe torque off (STO) as standard. Additional safety functions can be commissioned with the optional and compact safety functions module that includes safe stop 1 (SS1), safe stop emergency (SSE), safely-limited speed (SLS), safe brake control (SBC) and safe maximum speed (SMS). The drives' functional safety is designed according to EN IEC 61800-5-2 and complies with the requirements of the European Union Machinery Directive 2006/42/EC.

## Safe torque off as standard

Safe torque off (STO) is used to prevent unexpected startup and stopping-related functions, enabling safe machine maintenance and operation. With safe torque off activated, the drive will not provide a rotational field. This prevents the motor from generating torque on the shaft. This function corresponds to an uncontrolled stop in accordance with stop category 0 of EN 60204-1.

## The safety functions module

The easy to connect and configure safety functions module FSO-11 comes with a range of safety functions and a self-diagnostic function that meets current safety requirements and standards, in one compact module. Compared to using external safety components, the FSO-11 comes with the supported functions seamlessly integrated with the drive functionality, reducing the implementation of safety function connections and configuration. Installing FSO-11 results in less needs for cabling and provides a cost-effective solution packed into a single safety functions module to ensure safe drive operation. Commissioning and configuration of the safety functions is done with the Drive composer pro PC tool. The drive and FSO-11 is easy to connect to a safety PLC using PROFIsafe fieldbus adapter module (FENA-11).

The operational frequency of the FSO-11 is up to 200 Hz of the drives output. The safety functions module supports the following safety functions (which achieve up to SIL 3 or PL e safety level (Cat. 3)):

- **Safe stop 1 (SS1)** brings the machine to a stop using a monitored deceleration ramp. It is typically used in applications where the machinery motion needs to be brought to a stop in a controlled way before switching over to the no-torque state.
- **Safe stop emergency (SSE)** can be configured to, upon request, either activate STO instantly (category 0 stop), or first initiate motor deceleration and then, once the motor has stopped, activate the STO (category 1 stop).
- **Safe brake control (SBC)** provides a safe output for controlling the motor's external (mechanical) brakes, together with STO.
- **Safely-limited speed (SLS)** ensures that the specified speed limit of the motor is not exceeded. This allows machine interaction to be performed at slow speed without stopping the drive. FSO-11 comes with four individual SLS settings for speed monitoring.
- **Safe maximum speed (SMS)** monitors that the speed of the motor does not exceed the configured speed limit.

## Safety functions module

Option	Option code
FSO-11	+Q973



# Drive application programming with CODESYS

Automation Builder, ABB's new software suite for automation engineering, makes programming of industry devices such as drives, PLC's, robots and human machine interfaces (HMI) easy using one Integrated engineering suite. The Automation Builder is used both for engineering individual industry devices and for putting together entire automation projects. It is based on CODESYS, a widely used software environment that fulfills many different requirements of industrial automation projects, according to the IEC standard 61131-3. As a single tool, the Automation Builder reduces time typically needed for system configuration and programming. It also reduces the need for installing and maintaining separate programs simultaneously. Automation Builder enables the possibility to do online diagnostic checking of multiple tasks performed by different industrial devices such as ACS880 drives.

## Drive application programming

Automation Builder makes it possible for system integrators and machine builders to integrate their desired functionality and know-how directly into ACS880 drives. This is possible as ACS880 drives come with CODESYS programming capability embedded inside the drive. Designing a CODESYS-based application program in the drive makes the end user application run more efficiently, even without a separate programmable controller. It also brings higher end-product quality and requires less need for installation space and wiring.

Automation Builder lets you extend the standard functionality of parameter functions for ACS880 drives. This makes the ACS880 drives very flexible to meet exact requirements set for end user applications. The library management functionality in Automation Builder shortens engineering time as reuse of existing program code is possible. Additional features include the ability to select and use one of five different programming languages, effective program debugging and user password protection.

## Integrated engineering suite for operating several industry components together

Using the Drive manager tool embedded in Automation Builder together with ABB's AC500 PLC gives the user online connection to all drives in a fieldbus network. This speeds up commissioning and makes diagnostic of the entire automation system easy. Automation Builder saves all the configuration data of industry devices (including drive parameter settings) and program code to the same project archive. This makes engineering work more consistent and manageable.



### Automation Builder

One engineering tool to control all industry devices  
System configuration and diagnostic  
IEC programming  
Common project data handling

# Flexible connectivity to automation networks

Our fieldbus adapter modules enable communication between drives, systems, devices and software. Our industrial drives are compatible with a wide range of fieldbus protocols.

The plug-in fieldbus adapter module can easily be mounted inside the drive. Other benefits include reduced wiring costs when compared with traditional input/output connections. Fieldbus systems are also less complex than conventional systems, resulting in less overall maintenance.

## Multiple fieldbus connections for flexible control

ACS880 supports two fieldbus connections simultaneously. The user has flexibility of choice for control modes, and the possibility for redundant fieldbus adapters using the same protocol.

## Drive monitoring

A set of drive parameters and/or actual signals, such as torque, speed, current, etc., can be selected for cyclic data transfer, providing fast data access.

## Drive diagnostics

Accurate and reliable diagnostic information can be obtained through the alarm, limit and fault words.

## Drive parameter handling

The Ethernet fieldbus adapter module allows users to build an Ethernet network for drive monitoring and diagnostic and parameter handling purposes.

## Cabling

Substituting the large amount of conventional drive control cabling and wiring with a single cable reduces costs and increases system reliability and flexibility.

## Design

The use of fieldbus control reduces engineering time at installation due to the modular structure of the hardware and software and the simplicity of the connections to the drives.

## Commissioning and assembly

The modular machine configuration allows pre-commissioning of single machine sections and provides easy and fast assembly of the complete installation.

## Universal communication with ABB fieldbus adapters

The ACS880 supports the following fieldbus protocols:

### Fieldbus adapter modules

Option	Option code	Fieldbus protocol
FPBA-01	+K454	PROFIBUS DP, DPV0/DPV1
FCAN-01	+K457	CANopen®
FDNA-01	+K451	DeviceNet™
FENA-11	+K473	EtherNet/IP™, Modbus TCP, PROFINET IO, PROFI-safe *
FECA-01	+K469	EtherCAT®
FSCA-01	+K458	Modbus RTU
FEPL-02	+K470	PowerLink

\* For the PROFI-safe to work PROFINET fieldbus adapter module (FENA-11) and the safety functions module (FSO-11) are required.



# Input/output extension modules for increased connectivity

Standard input and output can be extended by using optional analog and digital input/output extension modules. The modules are easily installed in the extension slots located on the control unit.

## Analog and digital input/output extension modules

Option	Option code	Connections
FIO-01	+L501	4×DI/O, 2×RO
FIO-11	+L500	3×AI (mA/V), 1×AO (mA), 2×DI/O
FAIO-01	+L525	2×AI(mA/V), 2×AO(mA)

# Speed feedback interfaces for precise process control

ACS880 drives can be connected to various feedback devices, such as HTL pulse encoder, TTL pulse encoder, absolute encoder and resolver. The optional feedback module is installed in the option slot on the drive. It is possible to use two feedback modules at the same time, either of the same type or different type.

## Feedback interface modules

Option	Option code	Connections
FEN-01	+L517	2 inputs (TTL pulse encoder), 1 output
FEN-11	+L518	2 inputs (SinCos absolute, TTL pulse encoder), 1 output
FEN-21	+L516	2 inputs (Resolver, TTL pulse encoder), 1 output
FEN-31	+L502	1 input (HTL pulse encoder), 1 output

# I/O option extension adapter

For additional I/O option slots the FEA-03 is suitable for this use. An analog and digital input/output extension and speed feedback interface can be installed on the FEA-03. Two extension modules can be installed on each I/O extension slot. The connection to the control unit is via an fiber optic link and the adapter can be mounted on an DIN rail (35 x 7.5 mm).

## I/O extension adapter

Option	Option code	Connections
FEA-03	+L515	2×F-type option extension slots

# DDCS communication option modules

The FDCO-0X optical DDCS communication options are add-on modules on the ACS880 industrial drives control board. The modules include connectors for two fiber optic DDCS channels. The FDCO-0X modules make it possible to perform master-follower and AC800 M communication.

Option	Option code	Connections
FDCO-01	+L503	Optical DDCS (10 Mbd/10 Mbd)
FDCO-02	+L508	Optical DDCS (5 Mbd/10 Mbd)

# Remote monitoring access worldwide

The remote monitoring tool, NETA-21, gives easy access to the drive via the Internet or local Ethernet network. NETA-21 comes with a built-in web server. Being compatible with standard web browsers, it ensures easy access to a web-based user interface. Through the interface the user can configure drive parameters, monitor drive log data, and follow up load levels, run time, energy consumption, I/O data and bearing temperature of the motor connected to the drive.

The user can access the remote monitoring tool web page using 3G modem from anywhere with a standard PC, tablet or a mobile phone. The remote monitoring tool helps to reduce cost when personnel are able to monitor or perform maintenance for unmanned or manned applications in a range of industries. It is also very useful when more than one user wants to access the drive from several locations.

## Enhanced monitoring functions

The remote monitoring tool supports process and drive data logging. Values of process variables or drives actual

values can be logged to NETA-21's SD memory card which is situated in the remote monitoring tool or sent forward to a centralized database. NETA-21 does not need an external database as the remote monitoring tool is able to store valuable data of the drive during its entire lifetime.

Unmanned monitoring of processes or devices is ensured by the built-in alarm functions that notify maintenance personnel if a safety level is reached. Alarm history with true time stamps are stored internally to the memory card as well as technical data, which is provided by the drive for troubleshooting purposes. True time stamps are also used with drives that do not have a real time clock as standard for ensuring events of all connected drives.



NETA-21



# EMC – electromagnetic compatibility

Each ACS880 model can be equipped with a built-in filter to reduce high frequency emissions.

## EMC standards

The EMC product standard (EN 61800-3 (2004)) covers the specific EMC requirements stated for drives (tested with motor and cable) within the EU. EMC standards such as EN 55011 or EN 61000-6-3/4 are applicable to industrial and domestic equipment and systems including components inside the drive. Drive units complying with the requirements of EN 61800-3 are compliant with comparable categories in EN 55011 and EN 61000-6-3/4, but not necessarily vice versa. EN 55011 and EN 61000-6-3/4 do not specify cable length or require a motor to be connected as a load. The emission limits are comparable to EMC standards according to the table below.

## 1<sup>st</sup> environment versus 2<sup>nd</sup> environment

1<sup>st</sup> environment includes domestic premises. It also includes establishments directly connected without an intermediate transformer to a low voltage power supply network that supplies buildings used for domestic purposes.

2<sup>nd</sup> environment includes all establishments other than those directly connected to a low voltage power supply network that supplies buildings used for domestic purposes.

## EMC standards

EMC according to EN 61800-3 (2004) product standard	EN 61800-3 product standard	EN 55011, product family standard for industrial, scientific and medical (ISM) equipment	EN 61000-6-4, generic emission standard for industrial environments	EN 61000-6-3, generic emission standard for residential, commercial and light-industrial environment
1 <sup>st</sup> environment, unrestricted distribution	Category C1	Group 1, Class B	Not applicable	Applicable
1 <sup>st</sup> environment, restricted distribution	Category C2	Group 1, Class A	Applicable	Not applicable
2 <sup>nd</sup> environment, unrestricted distribution	Category C3	Group 2, Class A	Not applicable	Not applicable
2 <sup>nd</sup> environment, restricted distribution	Category C4	Not applicable	Not applicable	Not applicable

## Selecting an EMC filter

The following table gives the correct filter selection.

Type	Voltage	Frame sizes	1 <sup>st</sup> environment, restricted distribution, C2, grounded network (TN) Option code	2 <sup>nd</sup> environment, C3, grounded network (TN) Option code	2 <sup>nd</sup> environment, C3, ungrounded network (IT) Option code
ACS880-01	380 to 500 V	R1 to R9	+E202	+E200	+E201 (R6 to R9 frame size)
ACS880-01	690 V	R5 to R9	–	+E200 (R5 to R9 frame size)	+E201 (R7 to R9 frame size)
ACS880-07	380 to 500 V	R6 to R9	+E202	+E200	+E201

# Brake options

## Brake chopper

The brake chopper is built-in as standard for the ACS880-01 frame sizes R1 to R4. For other frames, a brake chopper is a selectable internal option. Braking control is integrated into the ACS880 single drives. It not only controls braking, but also supervises system status and detects failures such as brake resistor and resistor cable short-circuits, chopper short-circuit, and calculated resistor overtemperature.

## Brake resistor

The brake resistors are separately available for ACS880-01 and built in for the cabinet-built ACS880-07. Resistors other than the standard option resistors may be used, provided that the specified resistance value is not decreased and that the heat

dissipation capacity of the resistor is sufficient for the drive application. No separate fuses in the brake circuit are required if the conditions for eg. the mains cable is protected with fuses and no mains cable/fuse overrating takes place.



Brake resistor, SACE15RE13

# Brake options, ACS880-01

U <sub>N</sub> = 230 V (range 208 to 240 V)							
Brake chopper power		Brake resistor(s)				Type designation	Frame size
P <sub>brcont</sub> [kW]	R <sub>min</sub> ohm	Type	R [Ohm]	E <sub>r</sub> [kJ]	P <sub>rcont</sub> [kW]		
0.75	180	2xJBR-01*	240	44	0.21	ACS880-01-04A6-2	R1
1.1	180	2xJBR-01*	240	44	0.21	ACS880-01-06A6-2	R1
1.5	65	JBR-03	80	40	0.14	ACS880-01-07A5-2	R1
2.2	65	JBR-03	80	40	0.14	ACS880-01-10A6-2	R1
4	18	SACE15RE22	22	420	2	ACS880-01-16A8-2	R2
5.5	18	SACE15RE22	22	420	2	ACS880-01-24A3-2	R2
7.5	13	SACE15RE13	13	435	2	ACS880-01-031A-2	R3
11	12	SACE15RE13	13	435	2	ACS880-01-046A-2	R4
11	12	SACE15RE13	13	435	2	ACS880-01-061A-2	R4
18.5	6	SAFUR90F575	8	1800	4.5	ACS880-01-075A-2+D150	R5
22	6	SAFUR90F575	8	1800	4.5	ACS880-01-087A-2+D150	R5
30	3.5	SAFUR125F500	4	3600	9	ACS880-01-115A-2+D150	R6
37	3.5	SAFUR125F500	4	3600	9	ACS880-01-145A-2+D150	R6
45	2.4	SAFUR200F500	2.7	5400	13.5	ACS880-01-170A-2+D150	R7
55	2.4	SAFUR200F500	2.7	5400	13.5	ACS880-01-206A-2+D150	R7
75	1.8	2xSAFUR125F500*	2	7200	18	ACS880-01-274A-2+D150	R8

U <sub>N</sub> = 400 V (range 380 to 415 V)							
Brake chopper power		Brake resistor(s)				Type designation	Frame size
P <sub>brcont</sub> [kW]	R <sub>min</sub> ohm	Type	R [Ohm]	E <sub>r</sub> [kJ]	P <sub>rcont</sub> [kW]		
0.75	210	2xJBR-01*	240	44	0.21	ACS880-01-02A4-3	R1
1.1	210	2xJBR-01*	240	44	0.21	ACS880-01-03A3-3	R1
1.5	210	2xJBR-01*	240	44	0.21	ACS880-01-04A0-3	R1
2.2	210	2xJBR-01*	240	44	0.21	ACS880-01-05A6-3	R1
3	78	JBR-03	80	40	0.14	ACS880-01-07A2-3	R1
4	78	JBR-03	80	40	0.14	ACS880-01-09A4-3	R1
5.5	78	JBR-03	80	40	0.14	ACS880-01-12A6-3	R1
7.5	39	SACE08RE44	44	210	1	ACS880-01-017A-3	R2
11	39	SACE08RE44	44	210	1	ACS880-01-025A-3	R2
15	19	SACE15RE22	22	420	2	ACS880-01-032A-3	R3
18.5	19	SACE15RE22	22	420	2	ACS880-01-038A-3	R3
22	13	SACE15RE13	13	435	2	ACS880-01-045A-3	R4
22	13	SACE15RE13	13	435	2	ACS880-01-061A-3	R4
37	8	SAFUR90F575	8	1800	4.5	ACS880-01-072A-3+D150	R5
45	8	SAFUR90F575	8	1800	4.5	ACS880-01-087A-3+D150	R5
55	5.4	SAFUR80F500	6	2400	6	ACS880-01-105A-3+D150	R6
75	5.4	SAFUR80F500	6	2400	6	ACS880-01-145A-3+D150	R6
90	3.3	SAFUR125F500	4	3600	9	ACS880-01-169A-3+D150	R7
110	3.3	SAFUR125F500	4	3600	9	ACS880-01-206A-3+D150	R7
132	2.3	SAFUR200F500	2.7	5400	13.5	ACS880-01-246A-3+D150	R8
132	2.3	SAFUR200F500	2.7	5400	13.5	ACS880-01-293A-3+D150	R8
160	2	2xSAFUR125F500*	2	7200	18	ACS880-01-363A-3+D150	R9
160	2	2xSAFUR125F500*	2	7200	18	ACS880-01-430A-3+D150	R9

U <sub>N</sub> = 500 V (range 380 to 500 V)							
Brake chopper power		Brake resistor(s)				Type designation	Frame size
P <sub>brcont</sub> [kW]	R <sub>min</sub> ohm	Type	R [Ohm]	E <sub>r</sub> [kJ]	P <sub>rcont</sub> [kW]		
0.75	210	2xJBR-01*	240	44	0.21	ACS880-01-02A1-5	R1
1.1	210	2xJBR-01*	240	44	0.21	ACS880-01-03A0-5	R1
1.5	210	2xJBR-01*	240	44	0.21	ACS880-01-03A4-5	R1
2.2	210	2xJBR-01*	240	44	0.21	ACS880-01-04A8-5	R1
3	78	JBR-03	80	40	0.14	ACS880-01-05A2-5	R1
4	78	JBR-03	80	40	0.14	ACS880-01-07A6-5	R1
5.5	78	JBR-03	80	40	0.14	ACS880-01-11A0-5	R1
7.5	39	SACE08RE44	44	210	1	ACS880-01-014A-5	R2
11	39	SACE08RE44	44	210	1	ACS880-01-021A-5	R2
15	19	SACE15RE22	22	420	2	ACS880-01-027A-5	R3
18.5	19	SACE15RE22	22	420	2	ACS880-01-034A-5	R3
22	13	SACE15RE13	13	435	2	ACS880-01-040A-5	R4
22	13	SACE15RE13	13	435	2	ACS880-01-052A-5	R4
37	8	SAFUR90F575	8	1800	4.5	ACS880-01-065A-5+D150	R5
45	8	SAFUR90F575	8	1800	4.5	ACS880-01-077A-5+D150	R5
55	5.4	SAFUR80F500	6	2400	6	ACS880-01-096A-5+D150	R6
75	5.4	SAFUR80F500	6	2400	6	ACS880-01-124A-5+D150	R6
90	3.3	SAFUR125F500	4	3600	9	ACS880-01-156A-5+D150	R7
110	3.3	SAFUR125F500	4	3600	9	ACS880-01-180A-5+D150	R7
132	2.3	SAFUR200F500	2.7	5400	13.5	ACS880-01-240A-5+D150	R8
132	2.3	SAFUR200F500	2.7	5400	13.5	ACS880-01-260A-5+D150	R8
160	2.3	SAFUR200F500	2.7	5400	13.5	ACS880-01-361A-5+D150	R9
160	2.3	SAFUR200F500	2.7	5400	13.5	ACS880-01-414A-5+D150	R9

Note:  
\* = Connected in parallel

All brake resistors are to be installed outside the converter module.  
The SACE brake resistors are built-in to an IP21 metal housing.  
The SAFUR brake resistors are built-in to an IP00 metal frame.

# Brake options, ACS880-01

$U_N = 690 \text{ V}$ (range 525 to 690 V)							
Brake chopper power		Brake resistor(s)				Type designation	Frame size
$P_{brcont}$ [kW]	$R_{min}$ ohm	Type	$R$ [Ohm]	$E_r$ [kJ]	$P_{rcont}$ [kW]		
45***	18	2xJBR-01*	240	44	0.21	ACS880-01-07A3-7+D150	R5
45***	18	2xJBR-01*	240	44	0.21	ACS880-01-09A8-7+D150	R5
45***	18	SACE15RE22	22	420	2	ACS880-01-14A2-7+D150	R5
45***	18	SACE15RE22	22	420	2	ACS880-01-018A-7+D150	R5
45***	18	SACE15RE22	22	420	2	ACS880-01-022A-7+D150	R5
45***	18	SACE15RE22	22	420	2	ACS880-01-026A-7+D150	R5
45***	18	SACE15RE22	22	420	2	ACS880-01-035A-7+D150	R5
45***	18	SACE15RE22	22	420	2	ACS880-01-042A-7+D150	R5
45	18	SACE15RE22	22	420	2	ACS880-01-049A-7+D150	R5
55	13	SACE15RE13	13	435	2	ACS880-01-061A-7+D150	R6
65	13	SACE15RE13	13	435	2	ACS880-01-084A-7+D150	R6
90	8	SAFUR90F575	8	1800	4.5	ACS880-01-098A-7+D150	R7
110	8	SAFUR90F575	8	1800	4.5	ACS880-01-119A-7+D150	R7
132	6	SAFUR80F500	6	2400	6	ACS880-01-142A-7+D150	R8
160	6	SAFUR80F500	6	2400	6	ACS880-01-174A-7+D150	R8
200	4	SAFUR125F500	4	3600	9	ACS880-01-210A-7+D150	R9
250	4	SAFUR125F500	4	3600	9	ACS880-01-271A-7+D150	R9

Note:

\* = Connected in series

\*\*\* Please note that motor power is low compared to a corresponding drive and the motor cannot typically brake this power. For further information please contact your local ABB sales office.

All brake resistors are to be installed outside the converter module.

The SACE brake resistors are built-in to an IP21 metal housing.

The SAFUR brake resistors are built-in to an IP00 metal frame.

# Brake options, ACS880-07

$U_N = 400 \text{ V}$ (range 380 to 415 V)							
Brake chopper power		Brake resistor(s)				Type designation	Frame size
$P_{brcont}$ [kW]	$R_{min}$ ohm	Type	$R$ [Ohm]	$E_r$ [kJ]	$P_{rcont}$ [kW]		
55	5.4	SAFUR80F500	6	2400	6	ACS880-07-0105A-3+D150**	R6
75	5.4	SAFUR80F500	6	2400	6	ACS880-07-0145A-3+D150**	R6
90	3.3	SAFUR125F500	4	3600	9	ACS880-07-0169A-3+D150**	R7
110	3.3	SAFUR125F500	4	3600	9	ACS880-07-0206A-3+D150**	R7
132	2.3	SAFUR200F500	3	5400	13.5	ACS880-07-0246A-3+D150**	R8
132	2.3	SAFUR200F500	3	5400	13.5	ACS880-07-0293A-3+D150**	R8
160	2	2xSAFUR125F500*	2	8400	21	ACS880-07-0363A-3+D150**	R9
160	2	2xSAFUR125F500*	2	8400	21	ACS880-07-0430A-3+D150**	R9

$U_N = 500 \text{ V}$ (range 380 to 500 V)							
Brake chopper power		Brake resistor(s)				Type designation	Frame size
$P_{brcont}$ [kW]	$R_{min}$ ohm	Type	$R$ [Ohm]	$E_r$ [kJ]	$P_{rcont}$ [kW]		
55	5.4	SAFUR80F500	6	2400	6	ACS880-07-0096A-5+D150**	R6
75	5.4	SAFUR80F500	6	2400	6	ACS880-07-0124A-5+D150**	R6
90	3.3	SAFUR125F500	4	3600	9	ACS880-07-0156A-5+D150**	R7
110	3.3	SAFUR125F500	4	3600	9	ACS880-07-0180A-5+D150**	R7
132	2.3	SAFUR200F500	3	5400	13.5	ACS880-07-0240A-5+D150**	R8
132	2.3	SAFUR200F500	3	5400	13.5	ACS880-07-0260A-5+D150**	R8
160	2.3	SAFUR200F500	2	8400	21	ACS880-07-0361A-5+D150**	R9
160	2.3	SAFUR200F500	2	8400	21	ACS880-07-0414A-5+D150**	R9

Note:

\* = Connected in parallel

\*\* = +D151 if resistor is ordered

All brake resistors are to be installed inside the drive cabinet.

## Maximum braking power of the ACS880 equipped with the standard chopper and the standard resistor

$P_{brcont}$	Continuous brake chopper power. The value applies to the minimum resistance value. With a higher resistance value the $P_{brcont}$ may increase in some ACS880 units.
$R$	Resistance value for the listed resistor type.
$R_{min}$	Minimum allowable resistance value for the brake resistor.
$E_r$	Energy pulse that the resistor assembly will withstand (400 s duty cycle). This energy will heat the resistor element from 40 °C to the maximum allowable temperature.
$P_{rcont}$	Continuous power (heat) dissipation of the resistor when placed correctly. Energy $E_r$ dissipates in 400 seconds.

Brake resistor	Width (mm)	Depth (mm)	Weight (kg)
SACE08RE44	290	131	6.1
SACE15RE22	290	131	6.1
SACE15RE13	290	131	6.8
SAFUR80F500	300	345	14
SAFUR90F575	300	345	12
SAFUR160F380	300	345	25
SAFUR180F460	300	345	32
SAFUR125F500	300	345	25
SAFUR200F500	300	345	30
SAFUR210F575	300	345	27

## Additional width for ACS880-07

Resistor quantity	Width (mm)
1 × SAFUR	400
2 × SAFUR	800

# du/dt filters

du/dt filtering suppresses inverter output voltage spikes and rapid voltage changes that stress motor insulation. Additionally, du/dt filtering reduces capacitive leakage currents and high frequency emission of the motor cable as well as high frequency losses and bearing currents in the motor. The need for du/dt filtering depends on the motor insulation. For information on the construction of the motor insulation, consult the manufacturer.

If the motor does not fulfil the following requirements, the lifetime of the motor might decrease. Insulated N-end (non-driven end) bearings and/or common mode filters are also required for motor bearing currents with motors bigger than 100 kW. For more information, please see the ACS880 hardware manuals.

Please see below about how to select a filter according to the motor.

## Filter selection table for ACS880

Motor type	Nominal AC supply voltage	Requirements for		
		Motor insulation system	ABB du/dt and common mode filters, insulated N-end motor bearings	
			$P_N < 100 \text{ kW}$ and frame size < IEC 315	$100 \text{ kW} \leq P_N < 350 \text{ kW}$ or IEC 315 $\leq$ frame size < IEC 400
			$P_N < 134 \text{ hp}$ and frame size < NEMA 500	$134 \text{ hp} \leq P_N < 469 \text{ hp}$ or NEMA 500 $\leq$ frame size $\leq$ NEMA 580
<b>ABB motors</b>				
Random-wound M2___, M3___ and M4___	$U_N \leq 500 \text{ V}$	Standard	–	+ N
	$500 \text{ V} < U_N \leq 600 \text{ V}$	Standard	+ du/dt	+ du/dt + N
		or Reinforced	–	+ N
	$600 \text{ V} < U_N \leq 690 \text{ V}$ (cable length $\leq 150 \text{ m}$ )	Reinforced	+ du/dt	+ du/dt + N
$600 \text{ V} < U_N \leq 690 \text{ V}$ (cable length $> 150 \text{ m}$ )	Reinforced	–	+ N	
Form-wound HX___ and AM___	$380 \text{ V} < U_N \leq 690 \text{ V}$	Standard	n/a	+ N + CMF
Old* form-wound HX___ and modular	$380 \text{ V} < U_N \leq 690 \text{ V}$	Check with the motor manufacturer	+ du/dt with voltages over 500 V + N + CMF	
Random-wound HX___ and AM___**	$0 \text{ V} < U_N \leq 500 \text{ V}$	Enmelled wire with fiber glass taping	+ N + CMF	
	$500 \text{ V} < U_N \leq 690 \text{ V}$		+ du/dt + N + CMF	
HDP	Consult the motor manufacturer.			

\* Manufactured before 1.1.1998. \*\* For motors manufactured before 1.1.1998, check for additional instructions with the motor manufacturer.

## Non-ABB motors

Random-wound and form-wound	$U_N \leq 420 \text{ V}$	Standard $\hat{U}_{LL} = 1300 \text{ V}$	–	+ N or CMF
	$420 \text{ V} < U_N \leq 500 \text{ V}$	Standard $\hat{U}_{LL} = 1300 \text{ V}$	+ du/dt	+ du/dt + N or + du/dt + CMF
		or Reinforced: $\hat{U}_{LL} = 1600 \text{ V}$ , 0.2 microsecond rise time	–	+ N or CMF
	$500 \text{ V} < U_N \leq 600 \text{ V}$	Reinforced: $\hat{U}_{LL} = 1600 \text{ V}$	+ du/dt	+ du/dt + N or + du/dt + CMF
		or Reinforced: $\hat{U}_{LL} = 1800 \text{ V}$	–	+ N or CMF
	$600 \text{ V} < U_N \leq 690 \text{ V}$	Reinforced: $\hat{U}_{LL} = 1800 \text{ V}$	+ du/dt	+ du/dt + N
Reinforced: $\hat{U}_{LL} = 2000 \text{ V}$ , 0.3 microsecond rise time		–	+ N or CMF	

## The abbreviations used in the table are defined below

Abbr.	Definition
$U_N$	Nominal AC line voltage.
$\hat{U}_{LL}$	Peak line-to-line voltage at motor terminals which the motor insulation must withstand.
$P_N$	Motor nominal power.
du/dt	du/dt filter at the output of the drive. Available from ABB as an optional add-on kit.
CMF	Common mode filter. Depending on the drive type, CMF is available from ABB as a factory-installed option (+208) or as an optional add-on kit.
N	N-end bearing: insulated motor non-drive end bearing.
n/a	Motors of this power range are not available as standard units. Consult the motor manufacturer.

# du/dt filters

## External du/dt filters for ACS880-01

ACS880			du/dt filter type (3 filters included in kits marked *)														
			Unprotected (IP00)				Protected to IP22			Protected to IP54							
400 V	500 V	690 V	NOCH0016-60	NOCH0030-60	NOCH0070-60	NOCH0120-60 *	FOCH0260-70	FOCH0320-50	FOCH0610-70	NOCH0016-62	NOCH0030-62	NOCH0070-62	NOCH0120-62	NOCH0016-65	NOCH0030-65	NOCH0070-65	NOCH0120-65
02A4-3	02A1-5		x							x				x			
03A3-3	03A0-5		x							x				x			
	03A4-5		x							x				x			
04A0-3	04A8-5		x							x				x			
05A6-3	05A2-5		x							x				x			
07A2-3	07A6-5	07A3-7	x							x				x			
09A4-3		09A8-7	x							x				x			
12A6-3	11A0-5		x							x				x			
	014A-5	14A2-7	x							x				x			
017A-3			x							x				x			
	021A-5	018A-7		x						x					x		
	022A-7	022A-7		x						x					x		
025A-3	026A-7	026A-7		x						x					x		
	027A-5			x							x					x	
032A-3	034A-5	035A-7		x							x					x	
038A-3	040A-5	042A-7		x							x					x	
045A-3	052A-5	049A-7		x							x					x	
061A-3	065A-5			x							x					x	
072A-3				x							x					x	
	061A-7	061A-7			x							x					x
	077A-5				x							x					x
087A-3	084A-7	084A-7			x							x					x
105A-3	096A-5	098A-7			x							x					x
	124A-5	119A-7				x											
145A-3	156A-5	142A-7				x											
169A-3	180A-5	174A-7				x											
206A-3	240A-5	210A-7				x											
246A-3	260A-5	271A-7				x											
293A-3						x											
363A-3	361A-5						x										
430A-3	414A-5							x									

## Applicability

Separate du/dt filters are available for ACS880-01. Unprotected IP00 filters must be placed into an enclosure that provides an adequate degree of protection.

Factory-installed du/dt filters are available for the ACS880-07. They are installed inside the drive cabinet.

## Dimensions and weights of the du/dt filters

du/dt filter	Height (mm)	Width (mm)	Depth (mm)	Weight (kg)
NOCH0016-60	195	140	115	2.4
NOCH0016-62/65	323	199	154	6
NOCH0030-60	215	165	130	4.7
NOCH0030-62/65	348	249	172	9
NOCH0070-60	261	180	150	9.5
NOCH0070-62/65	433	279	202	15.5
NOCH0120-60**	200	154	106	7
NOCH0120-62/65	765	308	256	45
NOCH0260-60**	383	185	111	12
FOCH0260-70	382	340	254	47
FOCH0320-50	662	319	293	65
FOCH0610-70	662	319	293	65

\*\* 3 filters included, dimensions apply for one filter.



NOCH0016-62



NOCH0016-60



NOCH0016-65



FOCH0610-70



# Dimensioning tool for selecting the optimal drive

DriveSize is designed to help select the optimal drive, motor and transformer for the application. Based on data supplied by the user, the tool calculates and suggests which drive and motors to use. DriveSize uses technical specifications found in our technical catalogs and manuals. It provides default values which can be changed by the user.

DriveSize creates documents for drive and motor dimensioning based on the load, network and cooling data provided by the user. Dimensioning results can be viewed graphically and numerically in the tool.

The tool can be used to calculate currents and network harmonics for a single supply unit or a whole system. The user can import a user-defined motor database by using a separate template that comes with the installation package. DriveSize is easy to use and has shortcut keys to make navigation quicker.

## Easy to access and use

DriveSize is a free software and can be used either online or downloaded for PC from [www.abb.com/drives](http://www.abb.com/drives).



# Expertise at every stage of the value chain

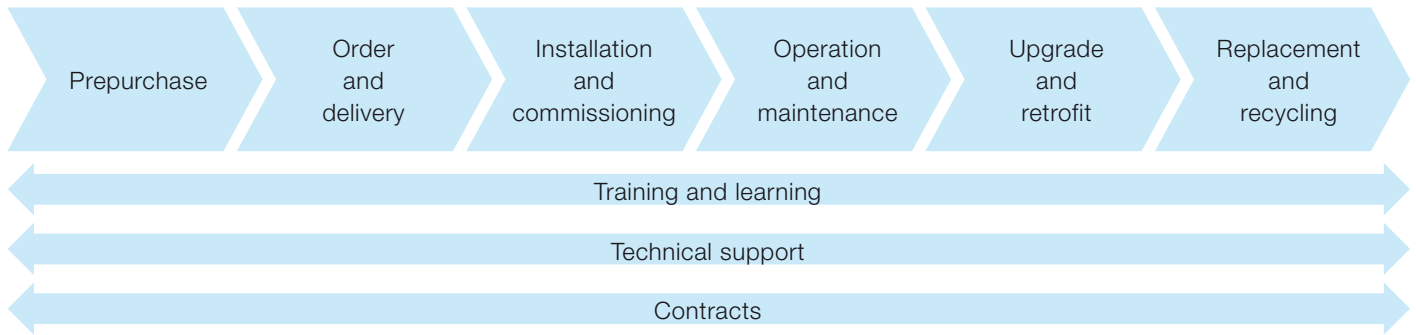

The services offered for ABB low voltage drives span the entire value chain, from the moment a customer makes the first enquiry through to disposal and recycling of the drive. Throughout the value chain, ABB provides training and learning, technical support and contracts. All of this is supported by one of the most extensive global drive sales and service networks.

## Pre-purchase

ABB provides a range of services that help guide the customers to the right products for their applications. Examples of services include correct drive selection and dimensioning, energy appraisal, harmonic survey and EMC assessment.

## Order and delivery

Orders can be placed through any ABB office or through ABB's channel partners. Orders can be placed and tracked online.

ABB's sales and services network offers timely deliveries including express delivery.

## Installation and commissioning

While many customers have the resources to undertake installation and commissioning on their own, ABB and its third party channel companies are available to advise or undertake the entire drive installation and commissioning.

## Operation and maintenance

Through remote monitoring, ABB can guide the customer through a fast and efficient fault-finding procedure as well as analyze the operation of the drive and the customer's process. From maintenance assessment to preventive maintenance and reconditioning of drives, ABB has all the options covered to keep its customers' processes operational.

Should corrective maintenance of drives be needed, ABB offers on-site and workshop repair, fully backed up by the most extensive spare holding.

## Upgrade and retrofit

An existing ABB drive can often be upgraded to the latest software or hardware to improve the performance of the application.

Existing processes can be economically modernized by retrofitting the latest drive technology to mechanical control equipment, such as inlet guide vanes or dampers or older generations of drives.

Instead of replacing an entire drive or drive system, it is often more economical to modernize the old installation by reusing all relevant parts of the original equipment and purchasing new where necessary.

## Replacement and recycling

ABB can advise on the best replacement drive while ensuring that the existing drive is disposed in a way that meets all local environmental regulations.

## Entire value chain services

The main services available throughout the value chain include:

- Training and learning – ABB offers product and application training in classrooms and on the Internet.
- Technical support – At each stage of the value chain, an ABB expert is available to offer advice to keep the customer's process or plant operational.
- Contracts – Drive care contracts and other types of agreements, from individual services through to complete drive care covering all repairs and even drive replacements, are available.

# Secure uptime throughout the drive life cycle

ABB follows a four-phase model for managing the life cycles of its drives. The life cycle phases are active, classic, limited and obsolete. Within each phase, every drive series has a defined set of services.

Examples of individual services are drive selection and dimensioning, installation and commissioning, preventive and corrective maintenance, remote monitoring and intelligent diagnostics, technical support, upgrade and retrofit, replacement and recycling plus training and learning.

In the active phase the drive is in serial production. The drive, with complete life cycle services, is available for purchase.

In the classic phase, the serial production of the drive has ended. The drive, with complete life cycle services, is available for plant extensions.

In the limited phase, the drive is no longer available. The life cycle services are limited. Spare parts as well as maintenance and repair services are available as long as materials can be obtained.

In the obsolete phase, the drive is not available. ABB cannot guarantee availability of services for technical reasons or within reasonable cost.

To ensure the availability of complete life cycle services, ABB recommends that a drive is kept in the active or classic phase by upgrading, retrofitting or replacing.

In the classic phase ABB carries out an annual review for each drive life cycle plan. Should any changes to the availability or duration of the services be necessary, ABB gives a life cycle announcement indicating eventual change of life cycle phase and/or any change in the duration of services.

In the limited phase, ABB issues a life cycle phase change announcement, half a year prior to shifting the product into the obsolete phase.

## Maximizing return on investment

The four-phase life cycle management model provides customers with a transparent method for managing their investment in drives. In each phase, customers clearly see what life cycle services are available, and more importantly, what services are not available. Decisions on upgrading, retrofitting or replacing drives can be made with confidence.

## ABB drive life cycle management model

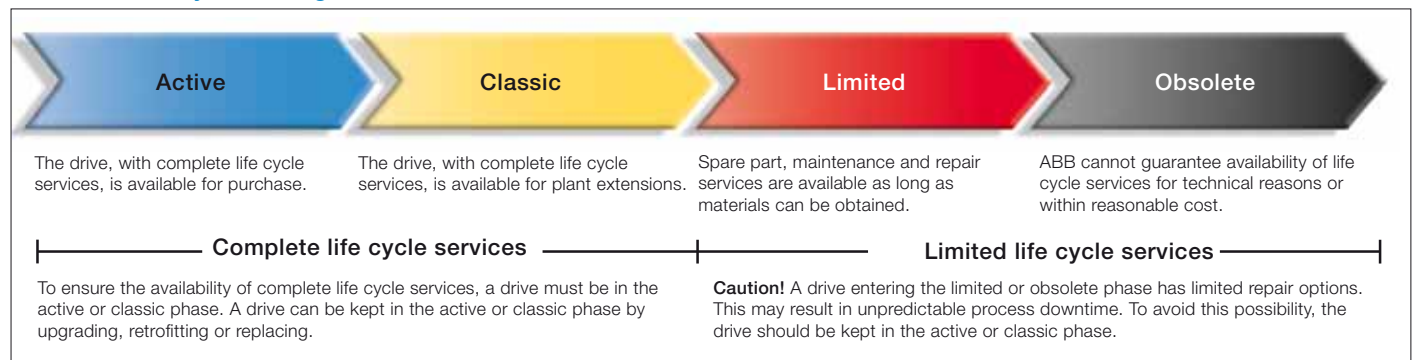







# Contact us

For more information please contact your local ABB representative or visit:

[www.abb.com/drives](http://www.abb.com/drives)

[www.abb.com/drivespartners](http://www.abb.com/drivespartners)

© Copyright 2013 ABB. All rights reserved.  
Specifications subject to change without notice.



3AUA0000098111 REV H EN 5.7.2013 #16826